



evolution wireless G4 IEM series

Instruction Manual



Overview 5

ew IEM G4 series products 6

EK IEM G4 stereo diversity receiver 7

SR IEM G4 stereo transmitter 8

Accessories 9

Earphones 9

IE 40 PRO 9

IE 400 PRO 10

IE 500 PRO 11

IE 4 12

Rechargeable battery and charger 13

BA 2015 rechargeable battery 13

L 2015 charger 13

Accessories for rack mounting 14

GA 3 rack mount kit 14

AM 2 antenna front mounting kit 14

Antennas and accessories 15

Omni-directional antennas 15

Directional antennas 15

Antenna combiner 15

Antenna cables 15

The frequency bank system 16

Installing and starting up ew IEM G4 series devices

17

Installing the EK IEM G4 18

Inserting and removing the batteries/rechargeable batteries 19

Battery status 20

Connecting earphones to the EK IEM G4 21

Attaching the diversity receiver to your clothing 22

Installing the SR IEM G4 23

Connectors on the rear of the device 24

SR IEM G4 rear side product overview 24

Connecting/disconnecting the SR IEM G4 with/from the power supply 25

Creating a data network 26

Connecting audio signals 27

Mono 27

Stereo 28

Daisy chaining audio signals 29

Connecting antennas 30

Installing the SR IEM G4 in a rack 31

Mounting a single transmitter in a rack 32

Mounting two receivers side by side in a rack 34

Installing the AC 41 35

Connectors on the rear of the device 36

Connecting/disconnecting the AC 41 to/from the power supply system 37

Connecting the AC 41 with transmitters 38

Connecting antennas 40



- Installing the AC 41 in a rack 41
- Mounting a single antenna combiner in a rack 42
- Mounting two antenna combiners side by side in a rack 43

Using ew IEM G4 series devices 44

Using the EK IEM G4 46

- Operating elements of the EK IEM G4 diversity receiver 47

- EK IEM G4** product overview 47

- Switching the EK IEM G4 on and off 49

- Lock-off function 50

- Displays on the EK IEM G4 display panel 51

- Buttons for navigating through the menu 52

- Home screen 54

- Frequency/Name** standard display 54

- Bank/Frequency/Limiter** standard display 55

- Frequency/High Boost** standard display 56

- Setting options in the menu 57

- Menu structure 58

- Squelch menu item 59

- Easy Setup menu item 61

- Scan New List 61

- Current List 61

- Reset 62

- Performing multi-channel frequency setup 62

- Frequency Preset menu item 67

- Name menu item 68

- Balance menu item 69

- Mode menu item 70

- High Boost menu item 71

- Auto Lock menu item 72

- Advanced menu item 73

- Advanced -> Tune menu item 74

- Only adjusting the frequency 74

- Setting the channel and frequency 74

- Advanced -> Limiter menu item 75

- Advanced -> Volume Boost menu item 76

- Advanced -> LCD Contrast menu item 76

- Advanced -> Engineer Mode menu item 77

- Profiles List 77

- Load Profiles 78

- Advanced -> Reset menu item 79

- Advanced -> Software Revision menu item 79

Using the SR IEM G4 80

- Operating elements of the SR IEM G4 transmitter 81

- Switching the SR IEM G4 on and off 82

- Using the headphone output 83

- Configuring the audio channels (mono/stereo) 84

- Deactivating the RF signal (RF mute) 85

- Lock-off function 86

- Displays on the SR IEM G4 display panel 87



- Buttons for navigating the SR IEM G4 menu 89
 - Navigating through the menu 89
 - Making changes in a menu item 89
- Setting options in the menu 90
- Sensitivity menu item 91
- Mode menu item 91
- Easy Setup menu item 91
- Frequency Preset menu item 92
- Name menu item 92
- Auto Lock menu item 93
- Advanced menu item 94
- Advanced > Tune menu item 95
 - Only adjusting the frequency 95
 - Setting the channel and frequency 95
- Advanced > Sync Settings menu item 96
- Advanced > RF Power menu item 96
- Advanced > Fullscreen Warnings menu item 97
- Advanced > Brightness menu item 97
- Advanced > Reset menu item 98
- Advanced > IP Address menu item 98
- Advanced > Software Revision menu item 98
- Establishing a radio link 99**
 - Setting notes 99
- Synchronizing devices 100**
 - Easy Setup Sync-function (EK IEM G4 -> SR IEM G4) for a single radio link 100
 - Easy Setup Sync-function (EK IEM G4 -> SR IEM G4) for multi-channel frequency setup 101
 - Sync function (SR IEM G4 -> EK IEM G4) 102
- Using the AC 41 104**
 - Operating elements on the front of the device 105
 - Switching the AC 41 on and off 106
 - Meaning of the LEDs 107
- Overview 108**
- Product variants 109**
 - EK IEM G4 product variants 109
 - Made in Germany 109
 - Assembled in the USA 109
 - SR IEM G4 product variants 110
 - Made in Germany 110
 - Assembled in the USA 110
 - AC 41 product variants 110
- Frequency tables 111**
- Specifications 112**
 - EK IEM G4 113
 - RF characteristics 113
 - AF characteristics 114
 - Overall device 114
 - SR IEM G4 115
 - RF characteristics 115



- AF characteristics 116
- Overall device 116
- IE 40 PRO earphones 117
- IE 400 PRO earphones 117
- IE 500 PRO earphones 117
- IE 4 earphones 118
- AC 41 119
 - Specifications 119
 - Block diagram 120

Pin assignment 121

- 3.5 mm stereo jack plug 121
- 6.3 mm stereo jack plug, balanced (audio in/loop out) 121
- 6.3 mm stereo jack plug for headphone jack 121
- XLR-3 plug, balanced 121
- Hollow jack plug for power supply 121

Cleaning and maintenance 122



PRODUCT INFORMATION

Overview

You can find information about the individual products in the ew IEM G4 series under “ew IEM G4 series products”.

For information about the available accessories, see “Accessories”.

You can find information about the ew IEM G4 series frequency bank system under “The frequency bank system”.

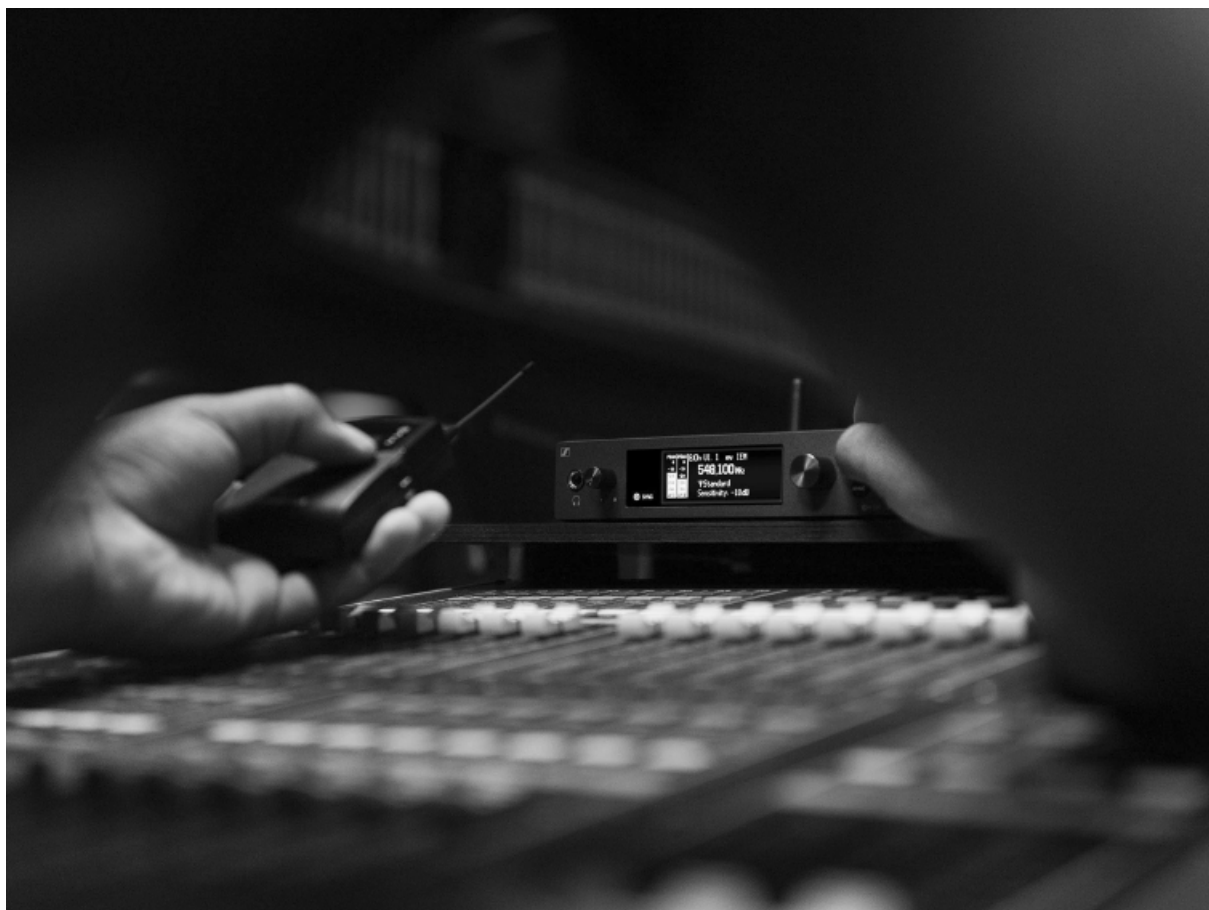



ew IEM G4 series products



You can also find more information here:

- A variety of frequency variants are available from the individual products. You can find more information under “Product variants”.
- You can find technical specifications about the individual products under “Specifications”.
- You can find information about installing the products under “Installing and starting up ew IEM G4 series devices”.
- You can find information about operating the products under “Using ew IEM G4 series devices”.



EK IEM G4 stereo diversity receiver



i You can find more detailed information about the EK IE MG4 in the following sections:

- Installation and Startup: “Installing the EK IEM G4”
 - Operation: “Using the EK IEM G4”
 - Technical Data: “EK IEM G4”
-



SR IEM G4 stereo transmitter



i You can find more detailed information about the SR IEM G4 in the following sections:

- Installation and Startup: “Installing the SR IEM G4”
 - Operation: “Using the SR IEM G4”
 - Technical Data: “SR IEM G4”
-



Accessories

A variety of accessories are available for the ew IEM G4 series.

Earphones

IE 40 PRO

IE 40 PRO BLACK - cat. no. 507481



IE 40 PRO CLEAR - cat. no. 507482



Technical data: see “IE 40 PRO earphones”



You can find more information about the earphones on their product page at:

www.sennheiser.com/ie-40-pro



IE 400 PRO

IE 400 PRO SMOKY BLACK - cat. no. 507483



IE 400 PRO CLEAR - cat. no. 507484



Technical data: see “IE 400 PRO earphones”



You can find more information about the earphones on their product page at:

www.sennheiser.com/ie-400-pro



IE 500 PRO

IE 500 PRO SMOKY BLACK - cat. no. 507479



IE 500 PRO CLEAR - cat. no. 507480



Technical data: see “IE 500 PRO earphones”



You can find more information about the earphones on their product page at:

www.sennheiser.com/ie-500-pro

**IE 4**

Article no. 500432



Technical data: see “IE 4 earphones”



You can find more information about the earphones on their product page at:

www.sennheiser.com/ie-4



Rechargeable battery and charger

BA 2015 rechargeable battery

The BA 2015 rechargeable battery is designed for use with evolution wireless G4 series handheld transmitters, bodypack transmitters and bodypack receivers.

Article no. 009950



L 2015 charger

The BA 2015 rechargeable battery can be charged in the L 2015 charger on its own or inside of the bodypack transmitter/bodypack receiver.

Article no. 009828





Accessories for rack mounting

GA 3 rack mount kit

19" rack adapter for mounting the EM 100 G4, EM 300 G4, EM 500 G4 or SR IEM G4 in a 19" rack.

Article no. 503167



AM 2 antenna front mounting kit

Antenna front mounting kit for installing antenna connections on the front of the rack when using the EM 100 G4, EM 300 G4, EM 500 G4 or SR IEM G4 together with the GA 3 rack mounting kit.

Article no. 009912





Antennas and accessories

The following antenna components are available as accessory parts.

Omni-directional antennas

- **A 1031-U**, passive omni-directional antenna, article no. 004645

Directional antennas

- **A 2003 UHF**, passive directional antenna, article no. 003658

Antenna combiner



- **AC 41**, active antenna combiner
 - **ASA 41-EU**, 470 – 870 MHz, article no. 508243
 - **AC 41-UK**, 470 – 870 MHz, article no. 508295
 - **AC 41-US**, 470 – 608 MHz, article no. 508244
 - See “Installing the AC 41” and “Using the AC 41”

Antenna cables

- **GZL 1019**, BNC/BNC coaxial cable, antenna cable with 50 Ω characteristic (wave) impedance
 - **GZL 1019-A1** variant, 1 m (3 ft), article no. 002324
 - **GZL 1019-A5** variant, 5 m (16 ft), article no. 002325
 - **GZL 1019-A10** variant, 10 m (16 ft), article no. 002326



The frequency bank system

There are different frequency ranges in the UHF band available for transmission.

The following frequency ranges are available for the **ew IEM G4** series:

- **A1 range:** 470 – 516 MHz
- **A range:** 516 – 558 MHz
- **AS range:** 520 – 558 MHz
- **G range:** 566 – 608 MHz
- **GB range:** 606 – 648 MHz
- **B range:** 626 – 668 MHz
- **C range:** 734 – 776 MHz
- **D range:** 780 – 822 MHz
- **TH range:** 794 – 806 MHz
- **E range:** 823 – 865 MHz

Every frequency range has **26 frequency banks** with up to 16 channels:

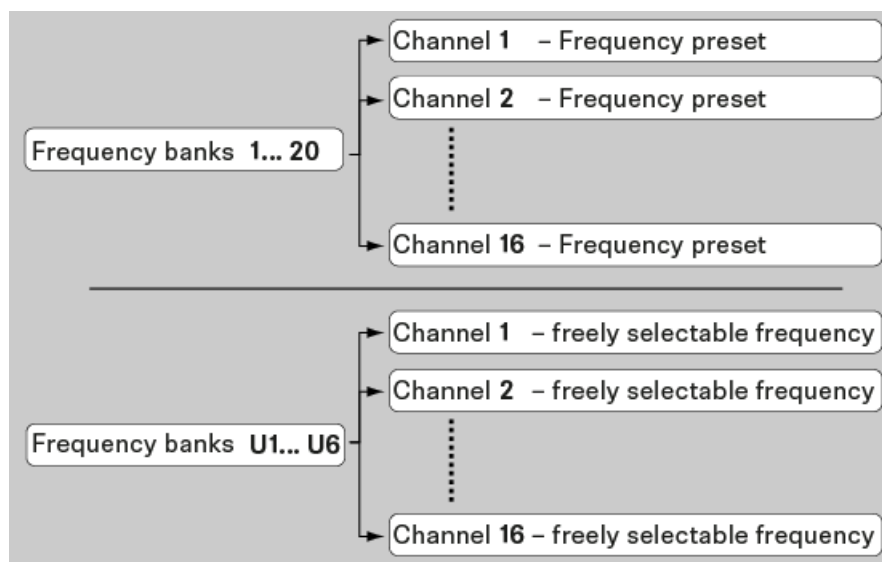

i You can find information about the frequency presets in the frequency tables of the respective frequency ranges under “Frequency tables”.



INSTALLATION

Installing and starting up ew IEM G4 series devices

You can find information about installing and connecting ew IEM G4 series devices in the following sections.



- **EK IEM G4** diversity receiver >> “Installing the EK IEM G4”



- **SR IEM G4** stereo transmitter >> “Installing the SR IEM G4”



- **ASA 214** antenna combiner >> “Installing the AC 41”



You can find information about **operating** the products under “Using ew IEM G4 series devices”.



Installing the EK IEM G4

These sections contain detailed information about installing and starting up the EK IEM G4.

You can find information about operating the EK IEM G4 under “Using the EK IEM G4”.



Inserting and removing the batteries/rechargeable batteries

You can operate the diversity receiver either with batteries (AA, 1.5 V) or with the rechargeable Sennheiser BA 2015 battery.

- ▷ Press the two catches and open the battery compartment cover.
- ▷ Insert the batteries or the rechargeable battery as shown below. Please observe correct polarity when inserting the batteries.









- ▷ Close the battery compartment.
The cover locks into place with an audible click.



Battery status

Charge status of the batteries:

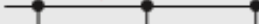
	100 %	> 8 h
	70 %	4 - 6 h
	30 %	2 - 3 h
LOW BATT 	  	 ...

Charge status is critical (LOW BATT):





Connecting earphones to the EK IEM G4

ATTENTION



Danger due to high volume levels

Volume levels that are too high may damage your hearing.

- ▷ Turn down the volume of the headphone output before you put on the headphone.

To connect the earphones to the receiver:

- ▷ Insert the cable's 3.5 mm jack plug into the **PHONES** socket on the receiver as shown in the diagram.



- i** The ground connection of the earphone cable acts as an antenna for the second diversity branch. For details on the pin assignment, see “Pin assignment”.



Attaching the diversity receiver to your clothing

You can use the belt clip to attach the diversity receiver to your waistband or on a guitar strap.

The belt clip is detachable so that you can also attach the diversity receiver with the antenna pointing downwards. To do so, withdraw the belt clip from its fixing points and attach it the other way round.



The belt clip is secured so that it cannot slide out of its fixing points accidentally.

To detach the belt clip:

- ▷ Lift the belt clip as shown in the diagram.

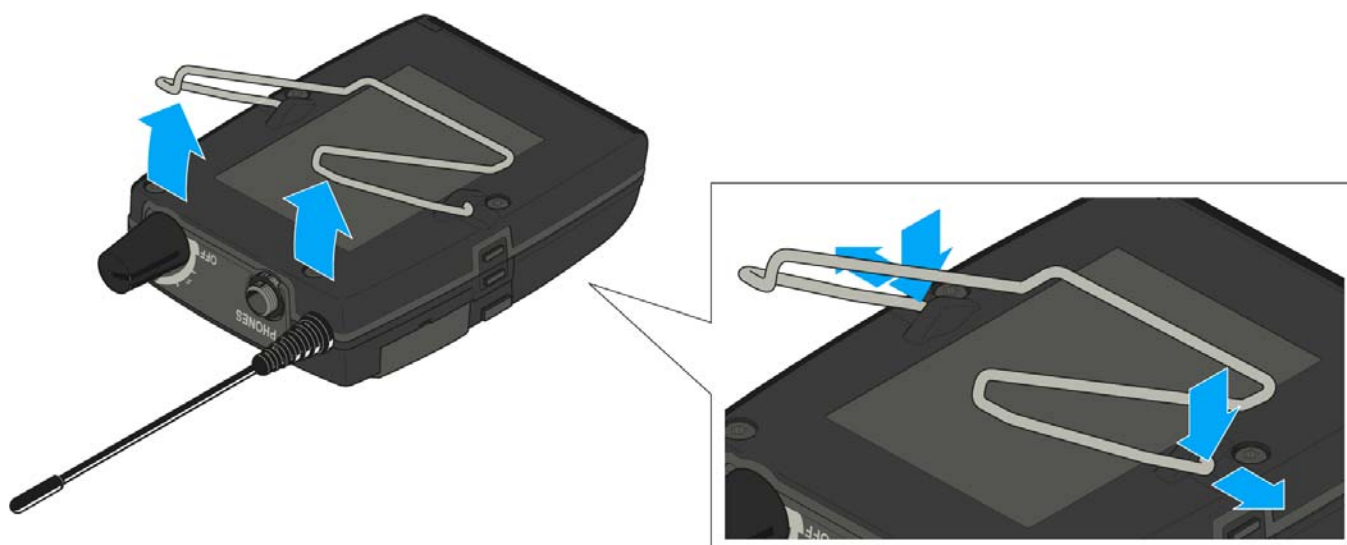

- ▷ Press one side of the clip downward on the fixing hole and pull it out of the housing.
- ▷ Do the same thing on the other side.



Installing the SR IEM G4

These sections contain detailed information about installing and starting up the SR IEM G4.

You can find information about operating the SR IEM G4 under “Using the SR IEM G4”.



Connectors on the rear of the device

SR IEM G4 [rear side product overview](#)

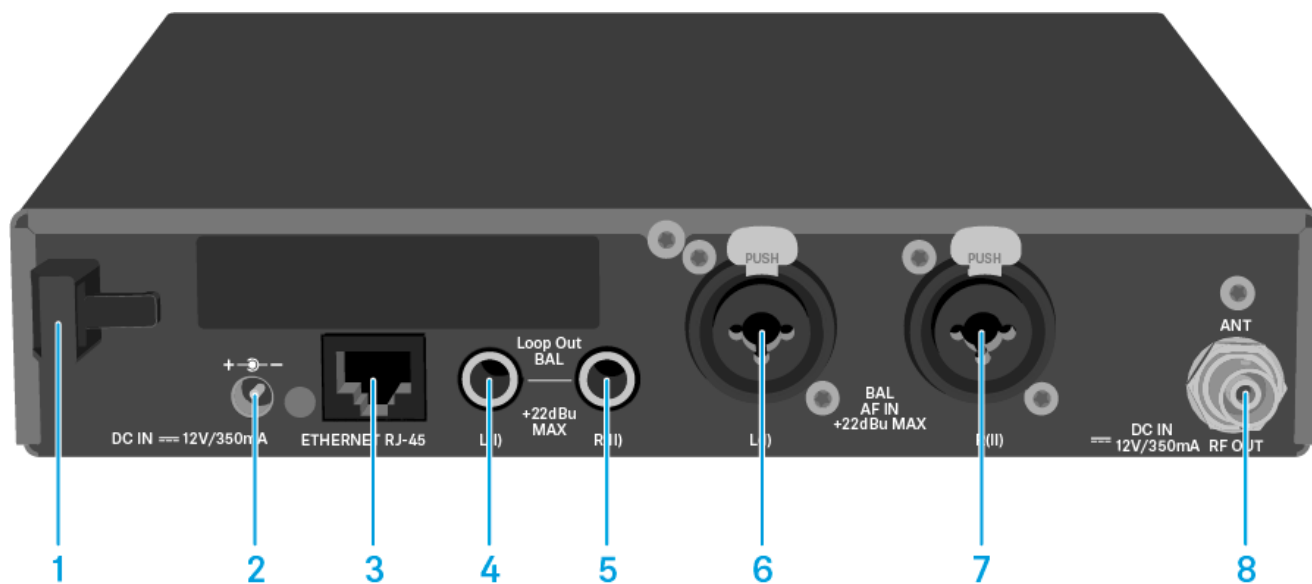

- 1** Strain relief for the cable of the power supply unit
 - See “Connecting/disconnecting the SR IEM G4 with/from the power supply”
- 2** DC IN socket
 - For connecting the power supply unit
 - See “Connecting/disconnecting the SR IEM G4 with/from the power supply”
- 3** LAN connection socket (**ETHERNET RJ 45**)
 - See “Creating a data network”
- 4** 6.3 mm jack socket **LOOP OUT BAL L(I)**
 - Audio output, left
 - See “Daisy chaining audio signals”
- 5** 6.3 mm jack socket **LOOP OUT BAL R(II)**
 - Audio output, right
 - See “Daisy chaining audio signals”
- 6** XLR-3/6.3 mm jack combo socket **BAL AF IN L(I)**
 - Audio input, left
 - See “Connecting audio signals”
- 7** XLR-3/6.3 mm jack combo socket **BAL AF IN R(II)**
 - Audio input, right
 - See “Connecting audio signals”
- 8** RF OUT BNC socket
 - Antenna output with remote power supply input
 - See “Connecting antennas”



Connecting/disconnecting the SR IEM G4 with/ from the power supply

Only use the supplied power supply unit. It is designed for your receiver and ensures safe operation.

To connect the SR IEM G4 transmitter to the power supply:

- ▷ Insert the plug of the power supply unit into the **DC IN** socket of the receiver.
- ▷ Pass the cable of the power supply unit through the cable grip.
- ▷ Slide the supplied country adapter onto the power supply unit.
- ▷ Plug the power supply unit into the wall socket.

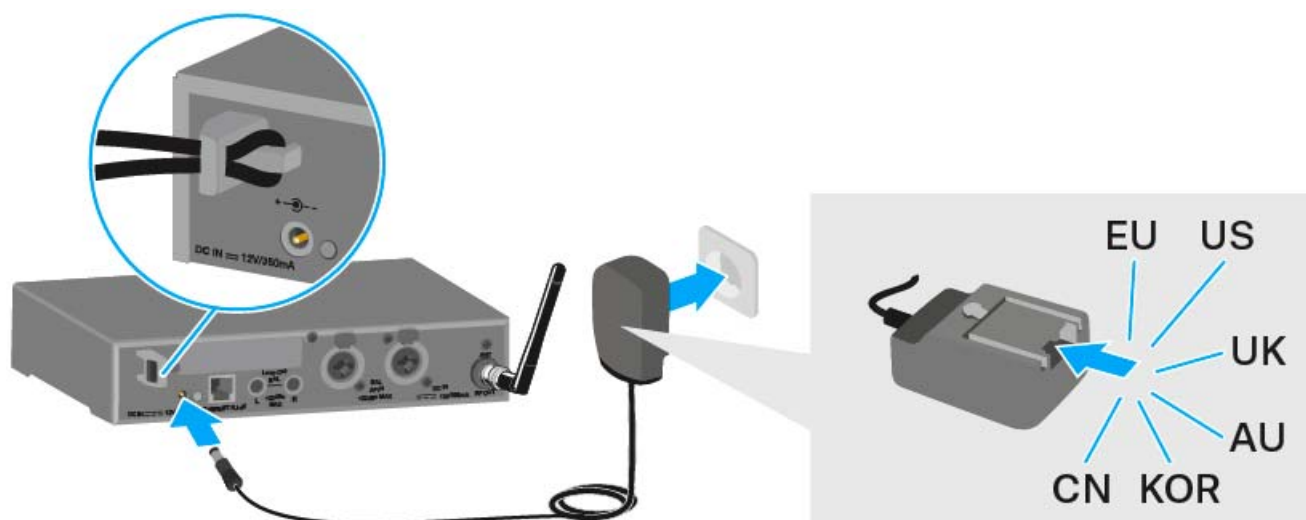

To disconnect the SR IEM G4 transmitter from the power supply:

- ▷ Unplug the power supply unit from the wall socket.
- ▷ Unplug the power supply unit from the **DC IN** socket of the receiver.



Creating a data network

You can monitor and control one or more SR IEM G4s via a network connection using **Sennheiser Wireless Systems Manager (WSM)** software.

i Automatic frequency setup can also be performed over the network without the WSM software. See “Easy Setup menu item”.

To connect the SR IEM G4 to a network:

- ▷ Connect a network cable with an RJ-45 connector (to the **Ethernet** socket on the rear side of the SR IEM G4).
- ▷ Connect the other end of the network cable to a network switch.

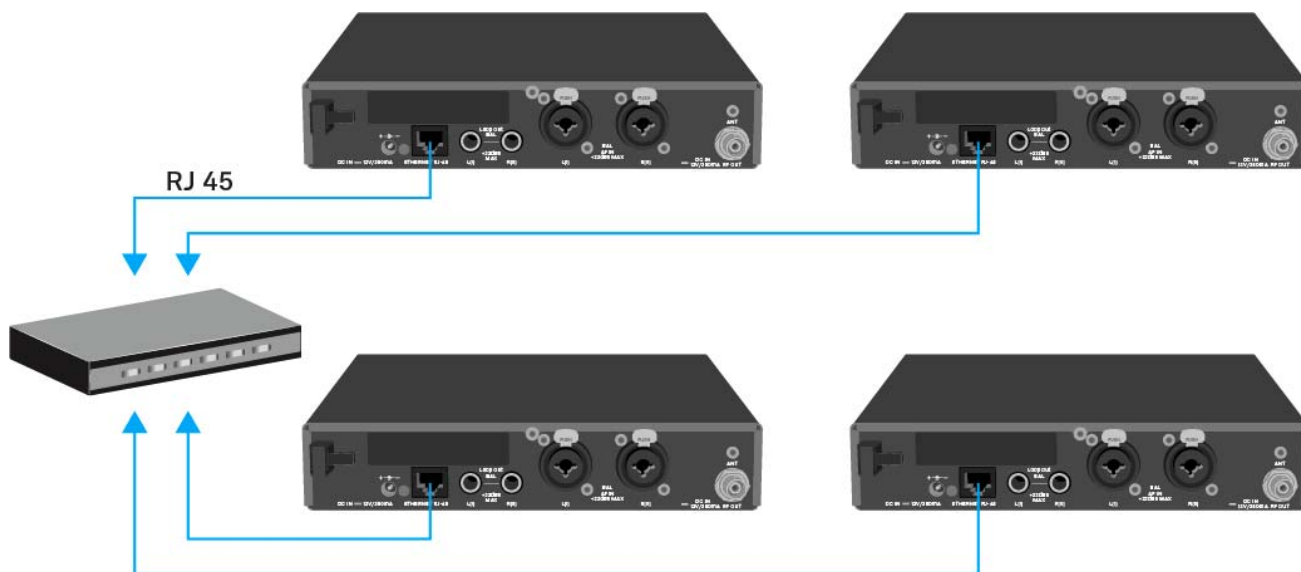

i For more information about controlling devices via the **Sennheiser Wireless Systems Manager (WSM)** software, refer to the instruction manual for the software. You can download the software here:

www.sennheiser.com/wsm



Connecting audio signals

You can connect Mono or Stereo signals via the two input sockets **BAL AF IN L(I)** and **BAL AF IN R(II)**.

To do so, the **SR IEM G4** must be configured for Mono or Stereo operation in the menu. See “Mode menu item”.

i In Stereo mode, you can receive the two input signals either as a **mixed mono signal** or as a **stereo signal**. To do so, you must select **Focus** or **Stereo** mode on the **EK IEM G4** receiver. See “Mode menu item”.

Mono

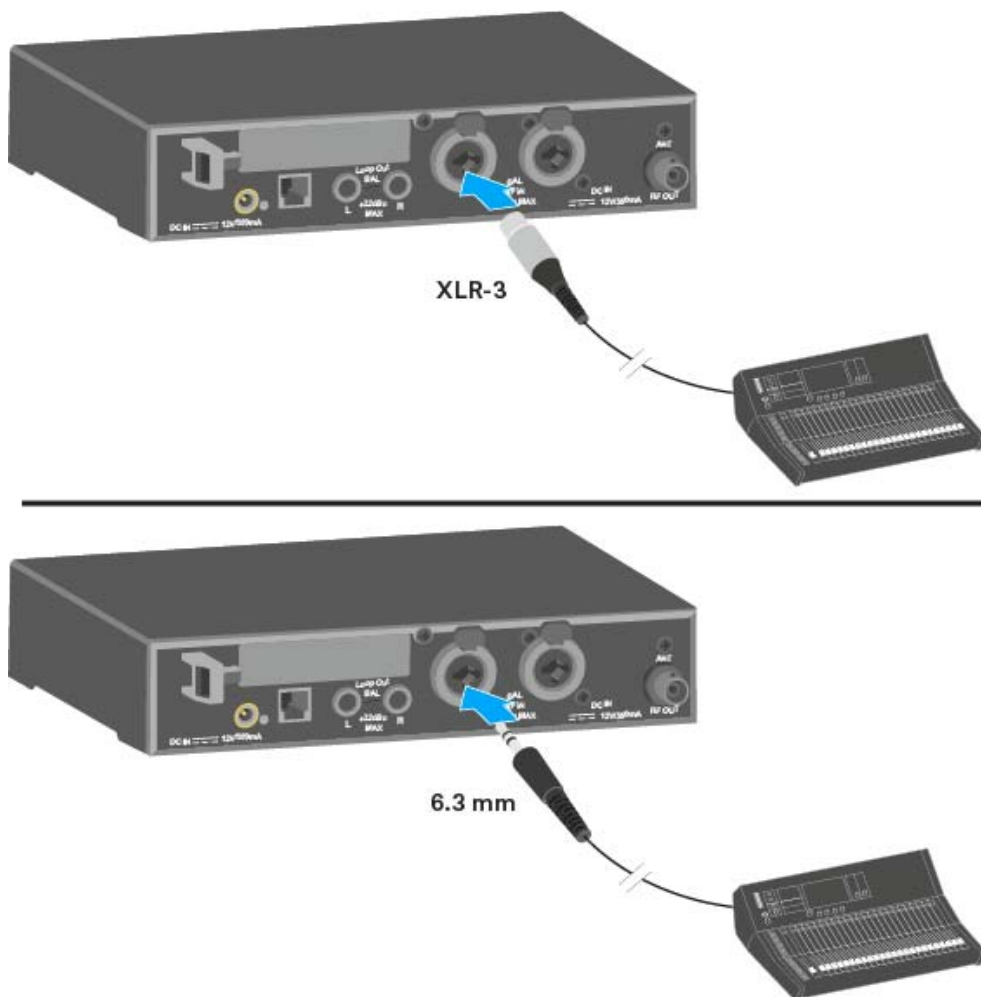

- ▷ Connect the output of an external device (e.g. a mixing console or another SR IEM G4) to the audio input socket **BAL AF IN L(I) + MONO** using a suitable cable.

i In Mono mode, the corresponding **EK IEM G4** receiver must be operated in **Focus** mode. See “Mode menu item”.



Stereo

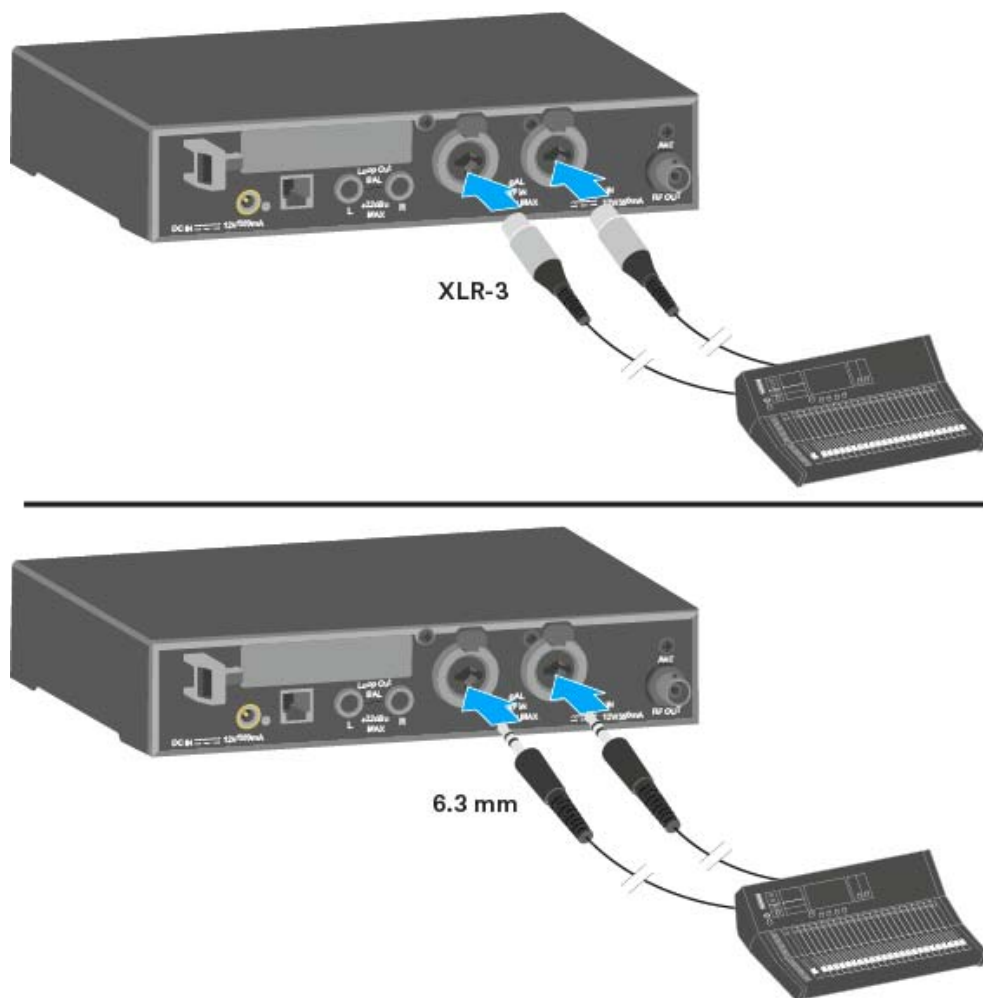

- ▷ Connect the output of an external device (e.g. a mixing console or another SR IEM G4) to the audio input sockets **BAL AF IN L(I)** and **BAL AF IN R(II)** using suitable cables.

i In Stereo mode, the corresponding **EK IEM G4** receiver can be operated in **Focus** mode or **Stereo** mode. See “Mode menu item”.



Daisy chaining audio signals

Using the **LOOP OUT BAL L** and/or **LOOP OUT BAL R** output sockets, it is possible to transmit a signal that you want to make available to all receivers from the mixing console to a transmitter and then to daisy chain this signal from the transmitter to the other transmitters.

In this way, for example, you can distribute an AUX path from the mixing console in Focus mode to multiple transmitters and output a separate signal on the other channel of the same transmitter (e.g. for the individual musician).

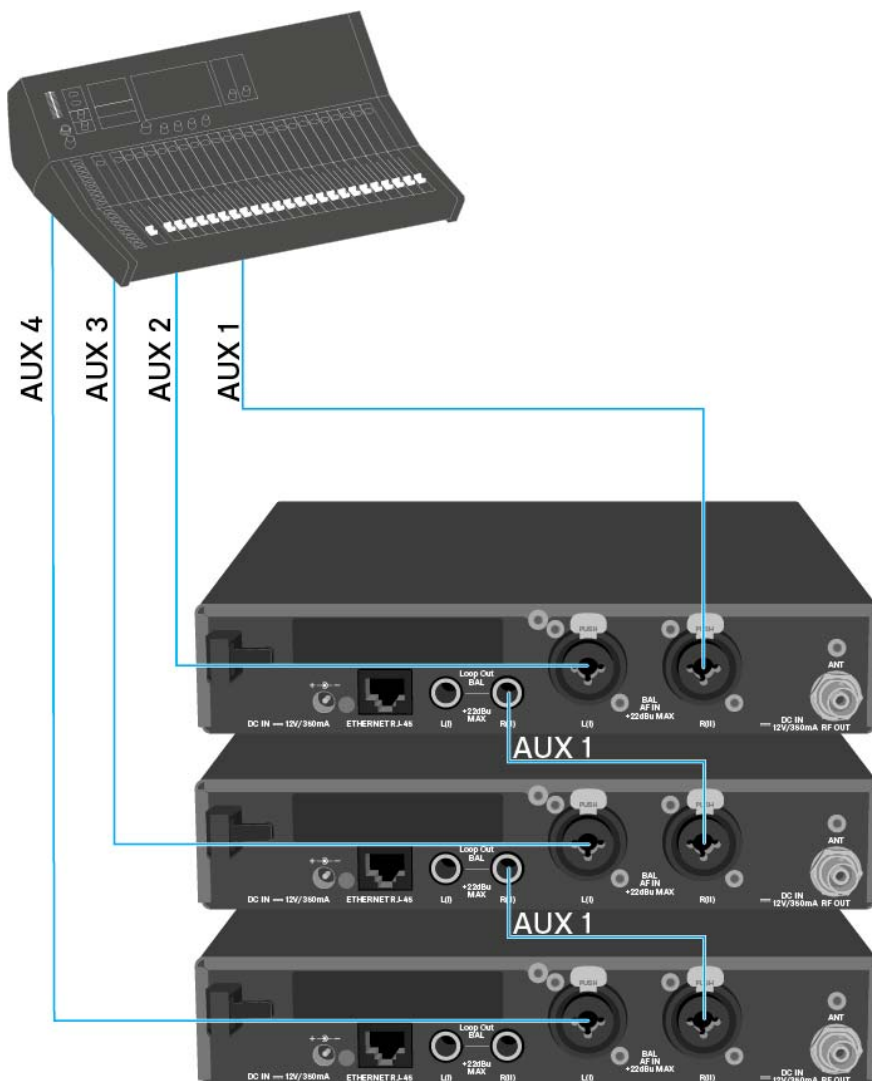

- ▷ Transmit a signal from the mixing console to the input socket of transmitter **A** (in this example: **BAL AF IN R**).
- ▷ Connect the **LOOP OUT BAL R** output socket of transmitter **A** with the **BAL AF IN R** input socket of transmitter **B**.
- ▷ Now connect the **LOOP OUT BAL R** output socket of transmitter **B** with the **BAL AF IN R** input socket of transmitter **C**.
- ▷ Continue on in this way for the remaining transmitters.



Connecting antennas

To connect the supplied rod antenna:

- ▷ Connect the rod antenna to the **RF OUT** socket on the rear side of the SR IEM G4.

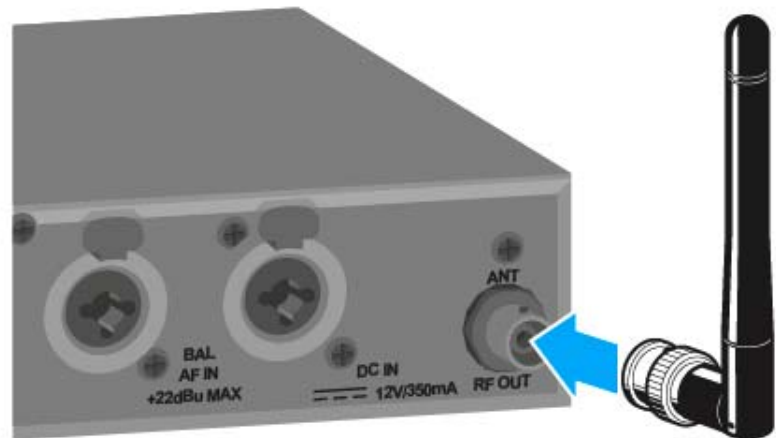

i If you are using more than one transmitter, we recommend using remote antennas and the AC 41 antenna combiner. You can find more information here:

- “Installing the AC 41”
- “Using the AC 41”



Installing the SR IEM G4 in a rack

CAUTION

Rack mounting poses risks

When installing the device in a closed or multi-rack assembly, please consider that, during operation, the ambient temperature, the mechanical loading and the electrical potentials will be different from those of devices which are not mounted into a rack.

- ▷ Make sure that the ambient temperature within the rack does not exceed the permissible temperature limit specified in the specifications. See “Specifications”.
 - ▷ Ensure sufficient ventilation; if necessary, provide additional ventilation.
 - ▷ Make sure that the mechanical loading of the rack is even.
 - ▷ When connecting to the power supply system, observe the information indicated on the type plate. Avoid circuit overloading. If necessary, provide overcurrent protection.
 - ▷ When rack mounting, please note that intrinsically harmless leakage currents of the individual power supply units may accumulate, thereby exceeding the allowable limit value. As a remedy, ground the rack via an additional ground connection.
-



Mounting a single transmitter in a rack

To mount the transmitter in a rack, you will need the GA 3 rack mounting kit (optional accessory).

To fasten the mounting angle of the GA 3 rack mounting kit:

- ▷ Unscrew and remove the two recessed head screws (M4x8) on each side of the transmitter.
- ▷ Secure the left and right mounting angles to the sides of the transmitter using the previously removed recessed head screws.

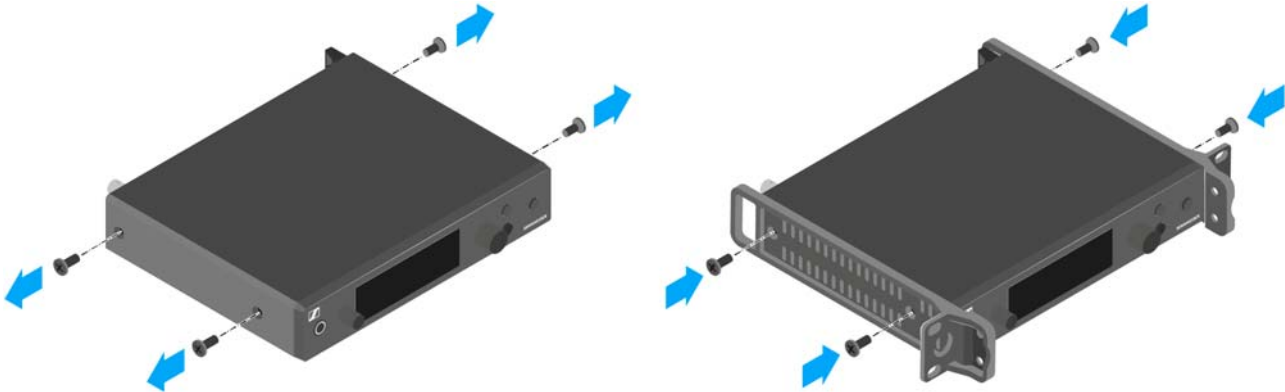

- ▷ Secure the blanking plate to one of the mounting angles using two recessed head screws (M6x10).

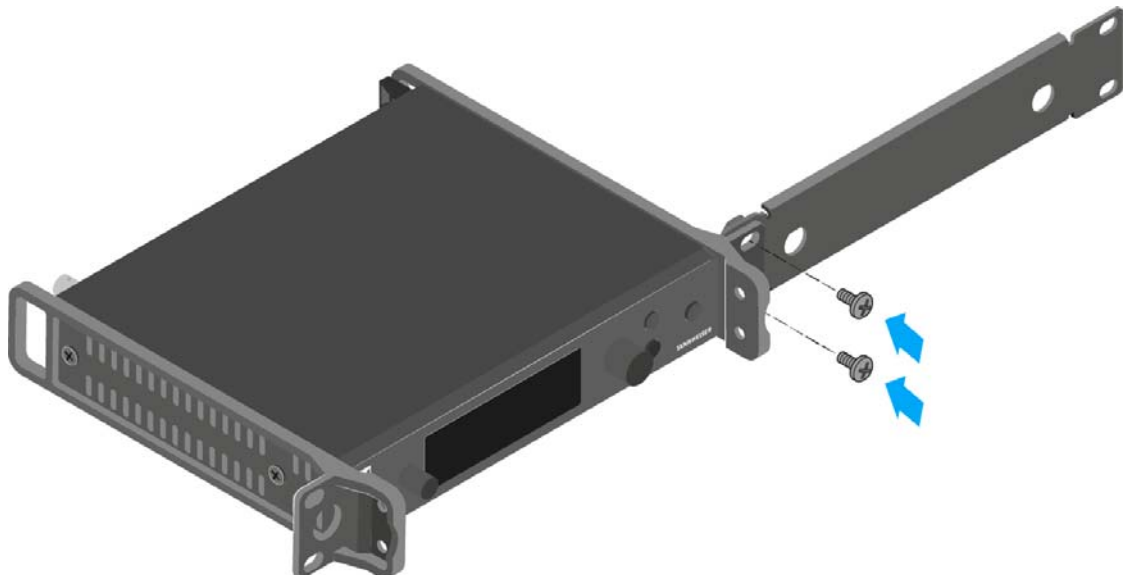



- ▷ Attach the antenna. You have the following options:
 - Connect the supplied rod antenna on the rear side of the transmitter. In this case, cover the antenna holes with the two covers (left diagram).
 - Attach the AM 2 antenna front mounting set (optional accessory) and mount the rod antenna on the blanking plate (right diagram).
 - Use a remote antenna, possibly in combination with the AC 41 antenna combiner.

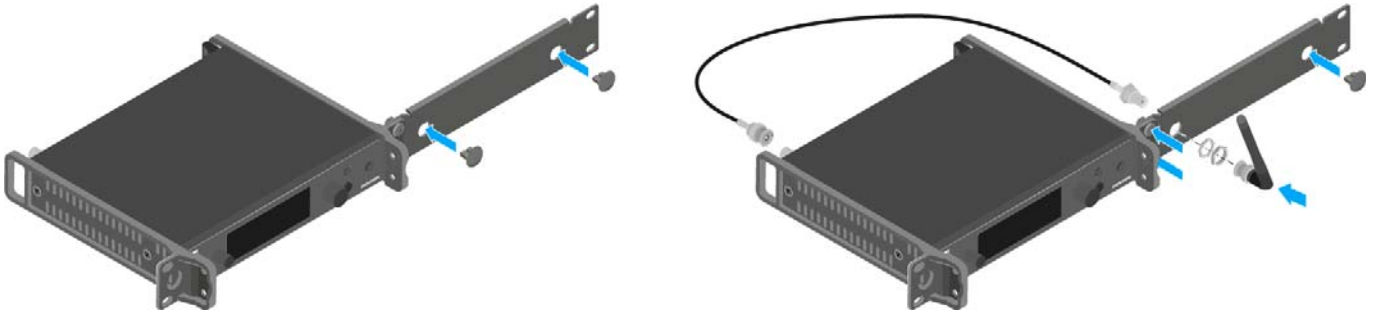

i If you are using more than one transmitter, we recommend using remote antennas and, as needed, Sennheiser antenna accessories. For more information, visit the ew G4 product page at www.sennheiser.com.

- ▷ Slide the transmitter with the mounted blanking plate into the 19" rack.
- ▷ Secure the mounting angle and the blanking plate to the 19" rack.
- ▷ Align the mounted antennas in a V-shape.



Mounting two receivers side by side in a rack

i If you want to mount two transmitters side by side, you can mount the antennas to the front of the rack in combination with the AC 41 antenna combiner. Otherwise, you can use the ASA 1 antenna splitter in combination with the AM 2 front mounting kit and an additional GA 3 rack mounting kit. For more information, visit the ew G4 product pages at www.sennheiser.com.

To mount the transmitter using the GA 3 rack mounting kit (optional accessory):

- ▷ Place both transmitters upside down and side by side on an even surface.
- ▷ Secure the jointing plate to the transmitters using the six recessed head screws (M3x6).
- ▷ Secure the mounting angle.

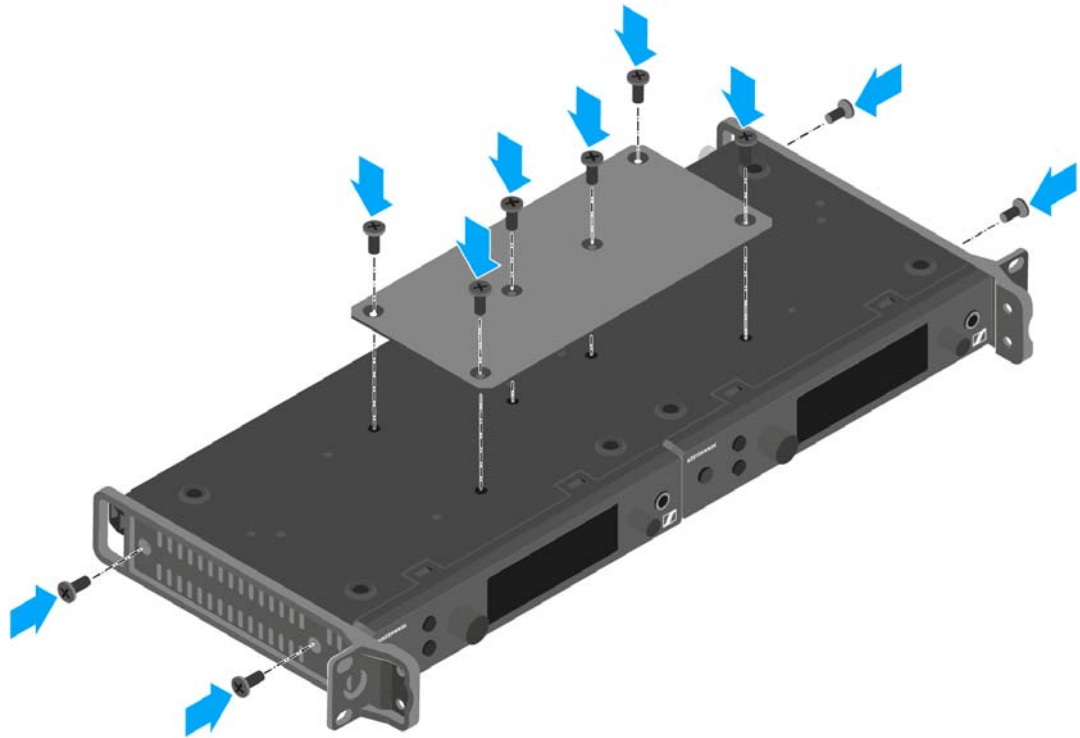

- ▷ Slide the connected transmitters into a 19" rack.
- ▷ Secure the mounting angle to the 19" rack.



Installing the AC 41

These sections contain detailed information about installing and starting up the AC 41.

You can find information about operating the AC 41 under “Using the AC 41”.



Connectors on the rear of the device

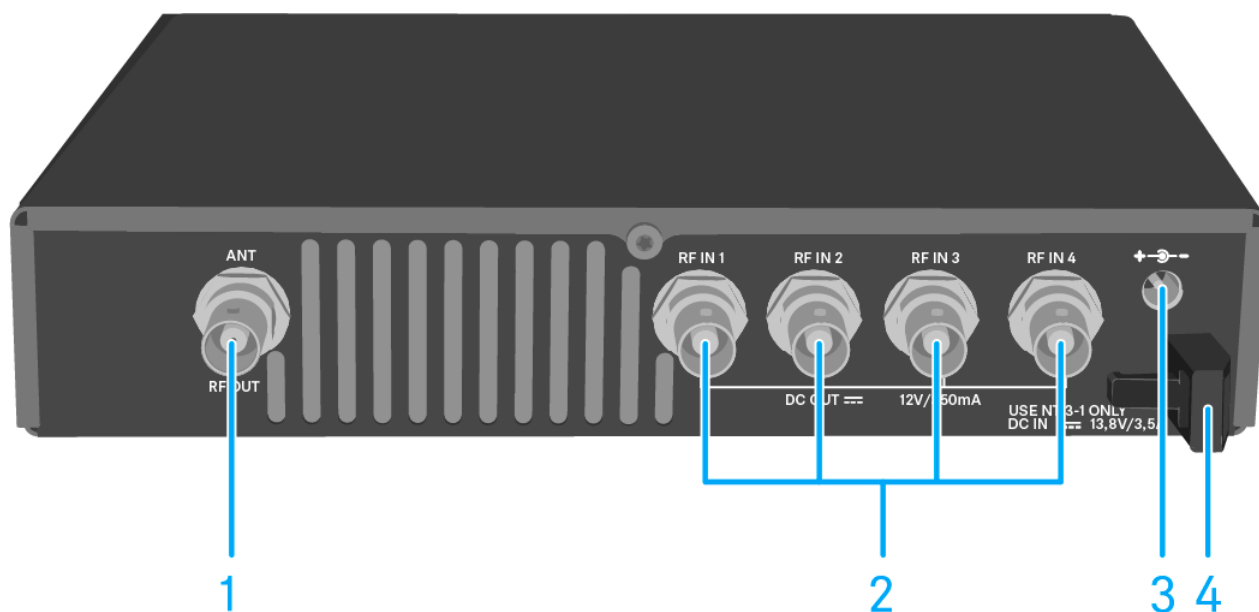

- 1 RF OUT** BNC socket
 - Antenna output
 - See “Connecting antennas”
- 2 RF IN 1** to **RF IN 4** BNC sockets
 - Antenna input with **DC OUT**
 - See “Connecting the AC 41 with transmitters”
- 3 DC IN** socket
 - To connect the NT 3-1 power supply unit
 - See “Connecting/disconnecting the AC 41 to/from the power supply system”
- 4** Strain relief for the cable of the power supply unit
 - See “Connecting/disconnecting the AC 41 to/from the power supply system”



Connecting/disconnecting the AC 41 to/from the power supply system

To supply power to the AC 41, the connected transmitters and any antenna amplifiers used, you will need the NT 3-1 power supply unit.

Only use the supplied NT 3-1 power supply unit. It is designed for your antenna combiner and ensures safe operation.

To connect the AC 41 antenna combiner to the power supply system:

- ▷ Connect the hollow jack plug of the power supply unit to the **DC IN** socket of the antenna combiner.
- ▷ Pass the cable of the power supply unit through the cable grip.
- ▷ Plug the supplied mains cable into the power supply unit.
- ▷ Plug the mains cable into the wall socket.

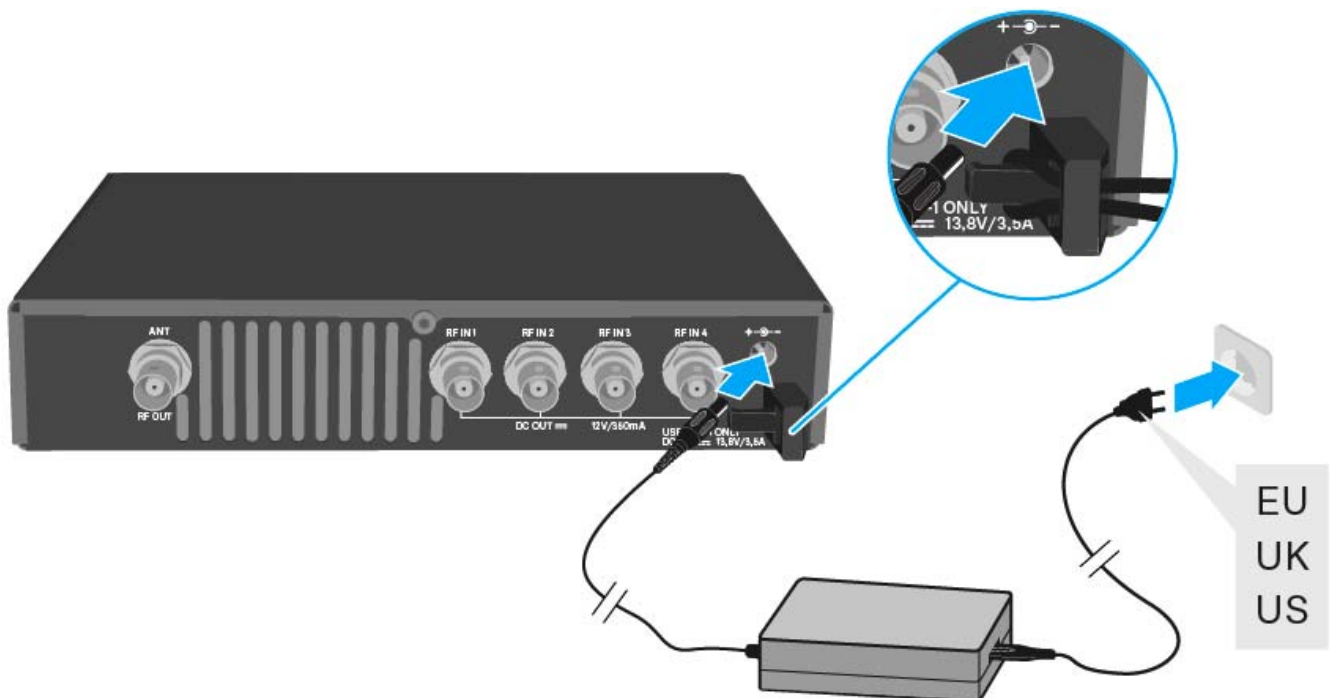

To completely disconnect the AC 41 antenna combiner from the power supply system:

- ▷ Unplug the mains cable from the wall socket.
- ▷ Unplug the hollow jack plug of the power supply unit from the **DC IN** socket of the antenna combiner.



Connecting the AC 41 with transmitters

You can connect and operate up to four stereo transmitters to the AC 41.

The following transmitters are compatible:

evolution wireless G4:

- SR IEM G4

evolution wireless G3:

- EK 300 IEM G3

2000 IEM series:

- SR 2000 IEM (with its own power supply)
- SR 2050 IEM (with its own power supply)



Due to legal reasons, the **transmission power** of the connected transmitter must be set to a maximum of **30 mW** (standard) when operating the AC 41. See “Advanced > RF Power menu item”.



To connect the transmitter to the antenna combiner:

- ▷ Connect one of the **RF IN** sockets of the AC 41 with the **RF OUT** jacks of a transmitter.
- ▷ Repeat the previous step until all four transmitters are connected to the antenna combiner.
- ▷ Connect the AC 41 to the power supply system (see “Connecting/disconnecting the AC 41 to/from the power supply system”).

The LEDs light up (see “Meaning of the LEDs”).

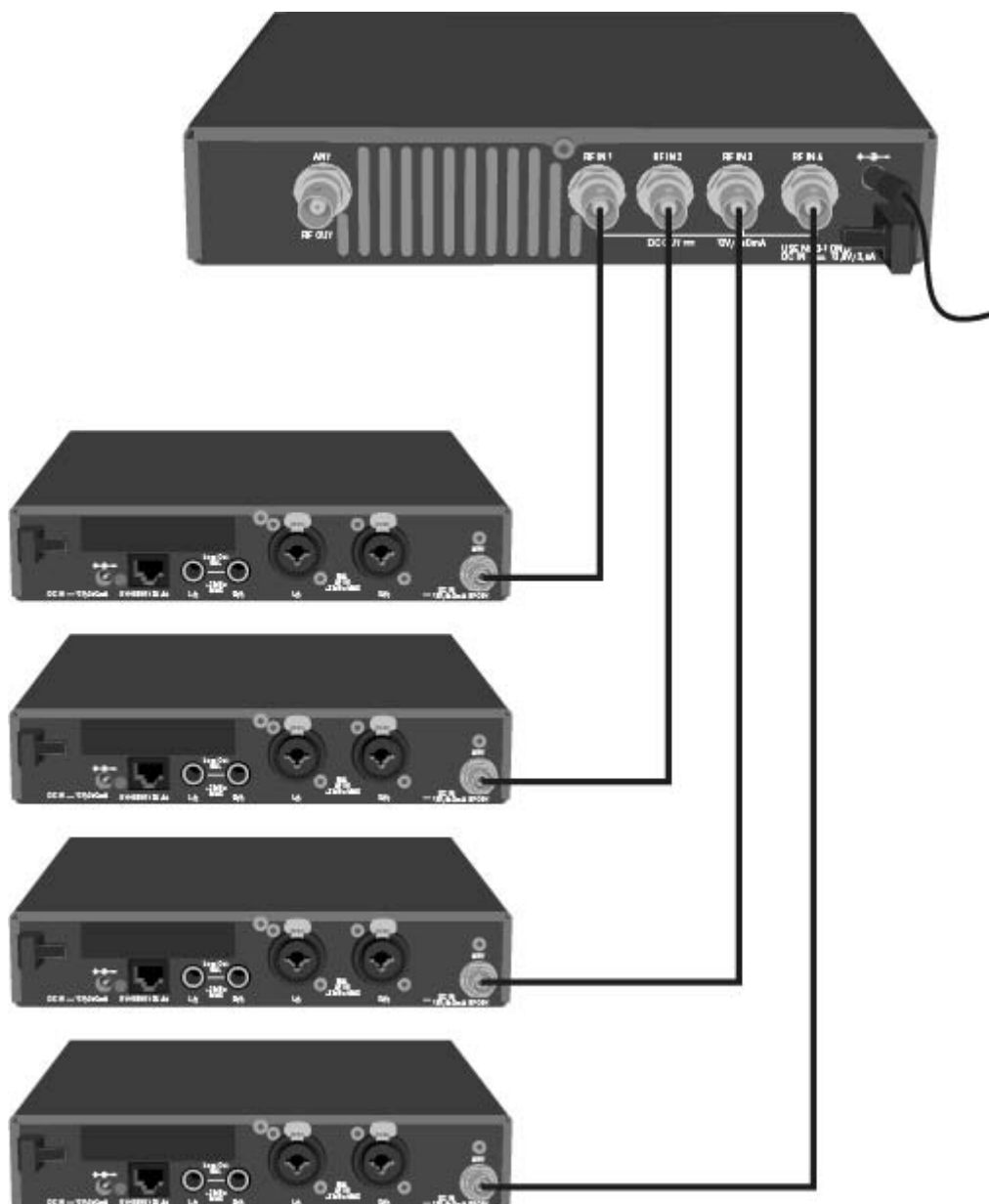

i The SR IEM G4 and SR 300 IEM G3 transmitters are supplied with voltage via the RF IN input sockets of the AC 41.



Connecting antennas

i For more information about antennas and antenna accessories, see “Antennas and accessories”.

i In order to ensure optimal reception even in the case of poor reception conditions, we recommend using remote antennas.

To connect a remote antenna:

- ▷ Connect the antenna and transmitter with a low-attenuation 50-Ω cable.
- ▷ Use the shortest antenna cable possible with few intermediary connections. The cable and transmitter will attenuate the wanted signal.
- ▷ Place the antenna in the room where the transmission is taking place.
- ▷ Maintain a distance of at least 1 m (3 ft) between the antenna and any metal objects.

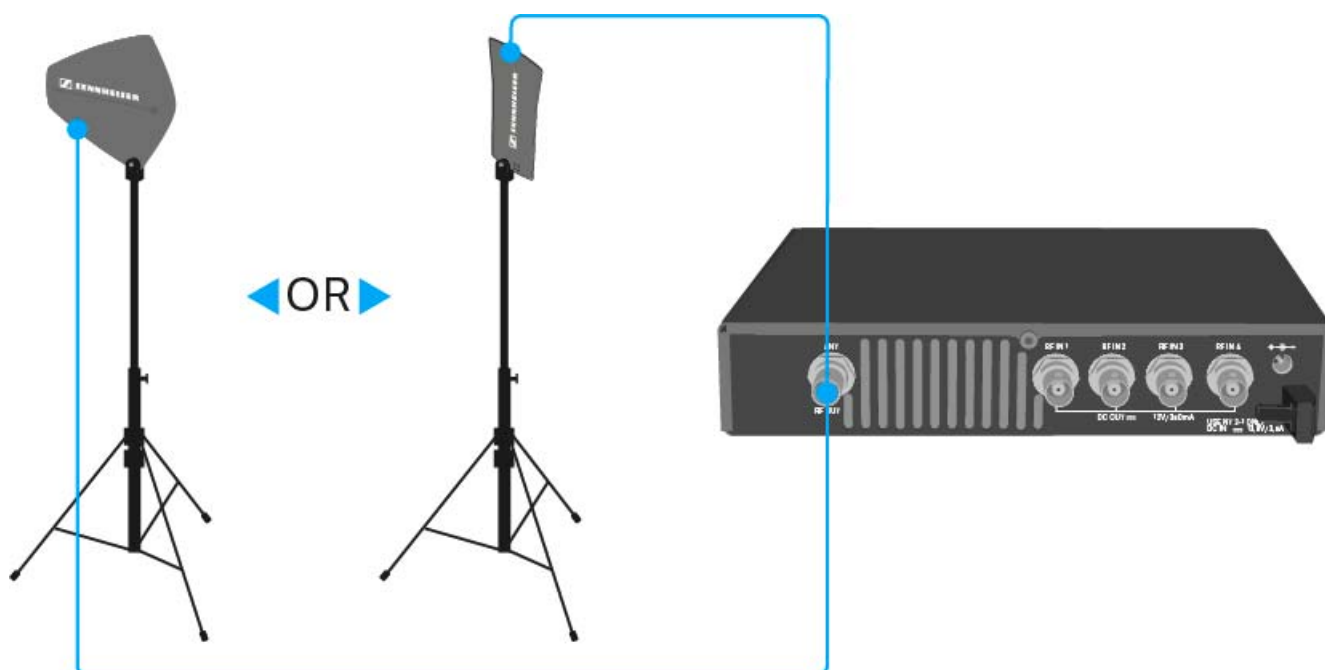



Installing the AC 41 in a rack

CAUTION

Rack mounting poses risks

When installing the device in a closed or multi-rack assembly, please consider that, during operation, the ambient temperature, the mechanical loading and the electrical potentials will be different from those of devices which are not mounted into a rack.

- ▷ Make sure that the ambient temperature within the rack does not exceed the permissible temperature limit specified in the specifications. See “Specifications”.
 - ▷ Ensure sufficient ventilation; if necessary, provide additional ventilation.
 - ▷ Make sure that the mechanical loading of the rack is even.
 - ▷ When connecting to the power supply system, observe the information indicated on the type plate. Avoid circuit overloading. If necessary, provide overcurrent protection.
 - ▷ When rack mounting, please note that intrinsically harmless leakage currents of the individual power supply units may accumulate, thereby exceeding the allowable limit value. As a remedy, ground the rack via an additional ground connection.
-



Mounting a single antenna combiner in a rack

To mount the antenna combiner in a rack, you will need the GA 3 rack mounting kit (optional accessory).

To fasten the mounting angle of the GA 3 rack mounting kit:

- ▷ Unscrew and remove the two recessed head screws (M4x8) on each side of the antenna combiner.
- ▷ Secure the mounting angles to the sides of the antenna combiner using the previously removed recessed head screws.

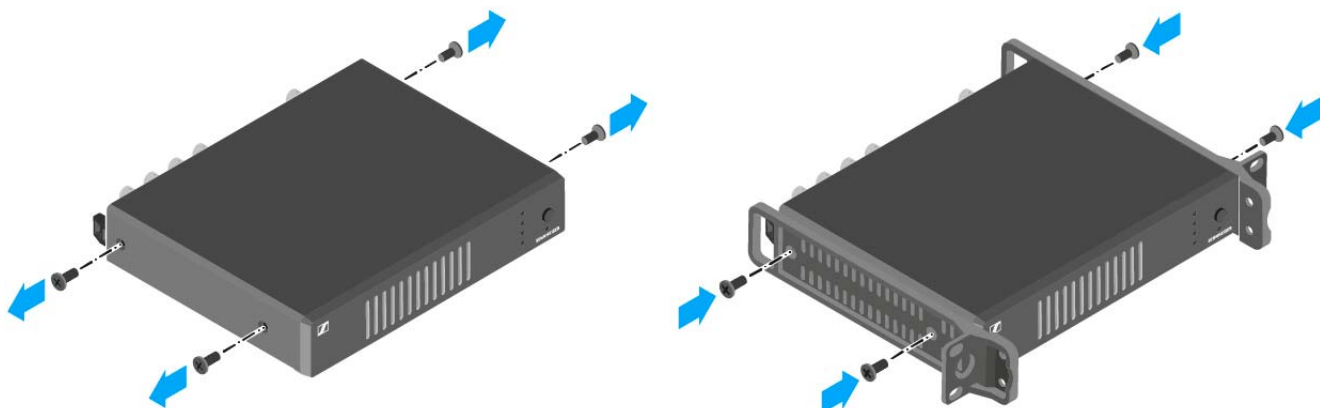

- ▷ Secure the blanking plate to one of the mounting angles using two recessed head screws (M6x10).
- ▷ Cover the antenna holes with the two covers.

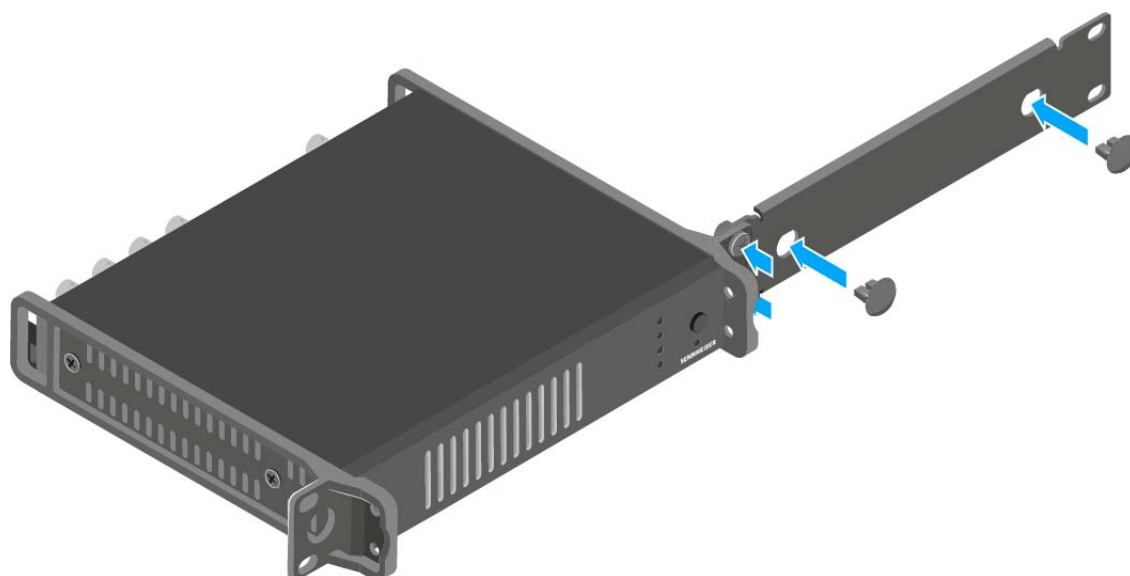

- ▷ Slide the antenna combiner with the mounted blanking plate into the 19" rack.
- ▷ Secure the mounting angle and the blanking plate to the 19" rack.



Mounting two antenna combiners side by side in a rack

To mount the antenna combiners using the GA 3 rack mounting kit (optional accessory):

- ▷ Place both antenna combiners upside down and side by side on an even surface.
- ▷ Secure the jointing plate to the transmitters using the six recessed head screws (M3x6).
- ▷ Secure the mounting angle.

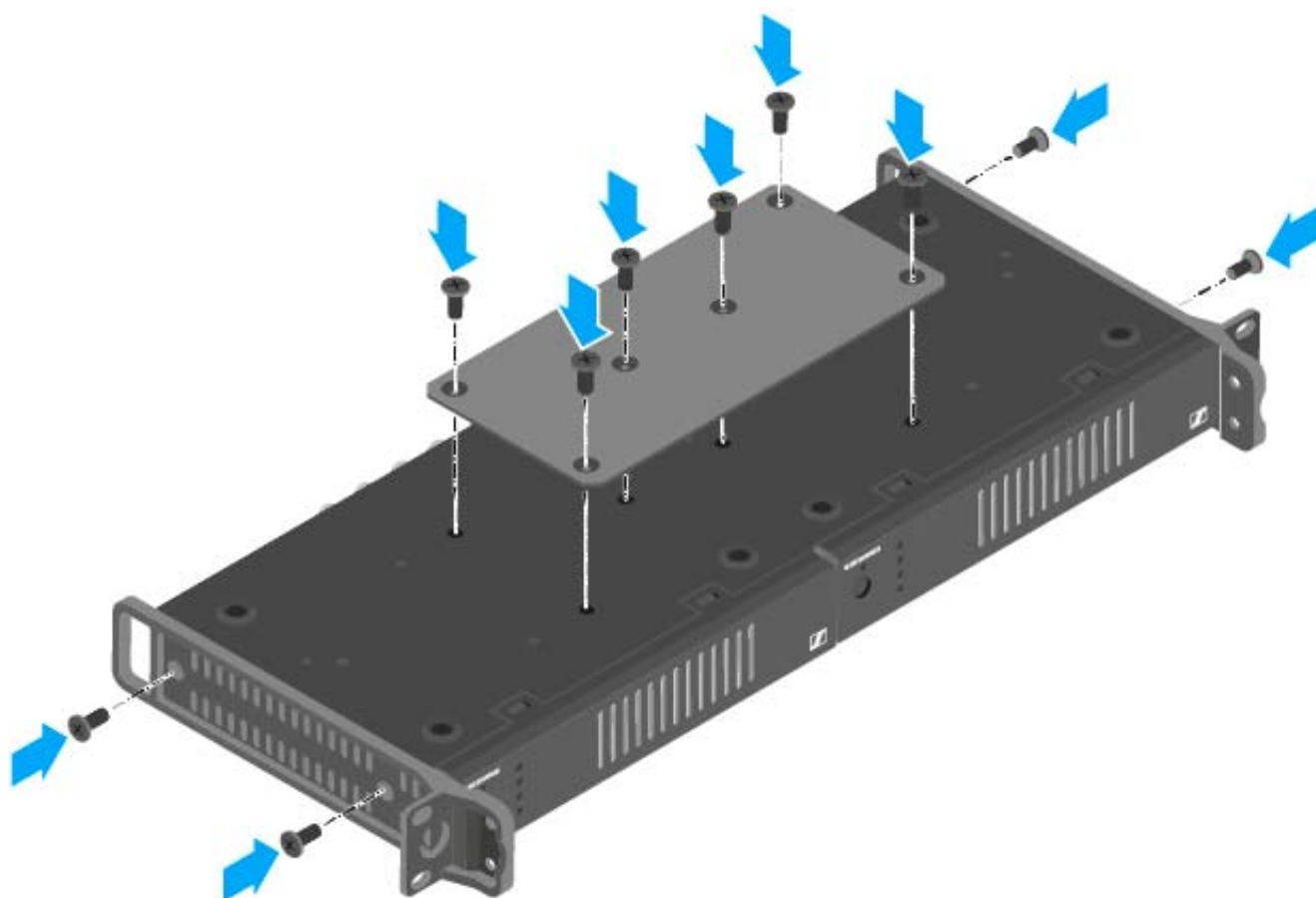

- ▷ Slide the connected antenna combiners into a 19" rack.
- ▷ Secure the mounting angle to the 19" rack.



OPERATION

Using ew IEM G4 series devices

You can find information about using ew IEM G4 series devices in the following sections.



- **EK IEM G4** diversity receiver >> “Using the EK IEM G4”



- **SR IEM G4** stereo transmitter >> “Using the SR IEM G4”

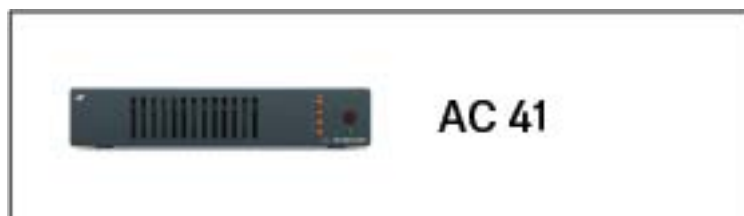

- **ASA 214** antenna combiner >> “Using the AC 41”



You can find information about **installation and start up** of the products under “Installing and starting up ew IEM G4 series devices”.

In the sections below, you can find important **information about specific use cases**.



- Establishing a **radio link** between the transmitter and receiver >> “Establishing a radio link”

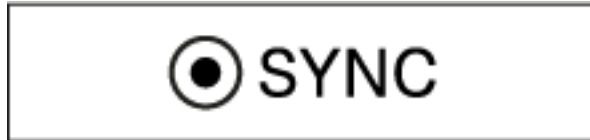

- **Synchronizing** the receiver **settings** to the transmitter >> “Synchronizing devices”



- Using the **menu** of the **receiver** >> “Displays on the EK IEM G4 display panel”



- Using the **menu** of the **transmitter** >> “Displays on the SR IEM G4 display panel”



Using the EK IEM G4

These sections contain detailed information about using the EK IEM G4.

You can find information on installation and startup of the EK IEM G4 under “Installing the EK IEM G4”.



Operating elements of the EK IEM G4 diversity receiver

EK IEM G4 product overview

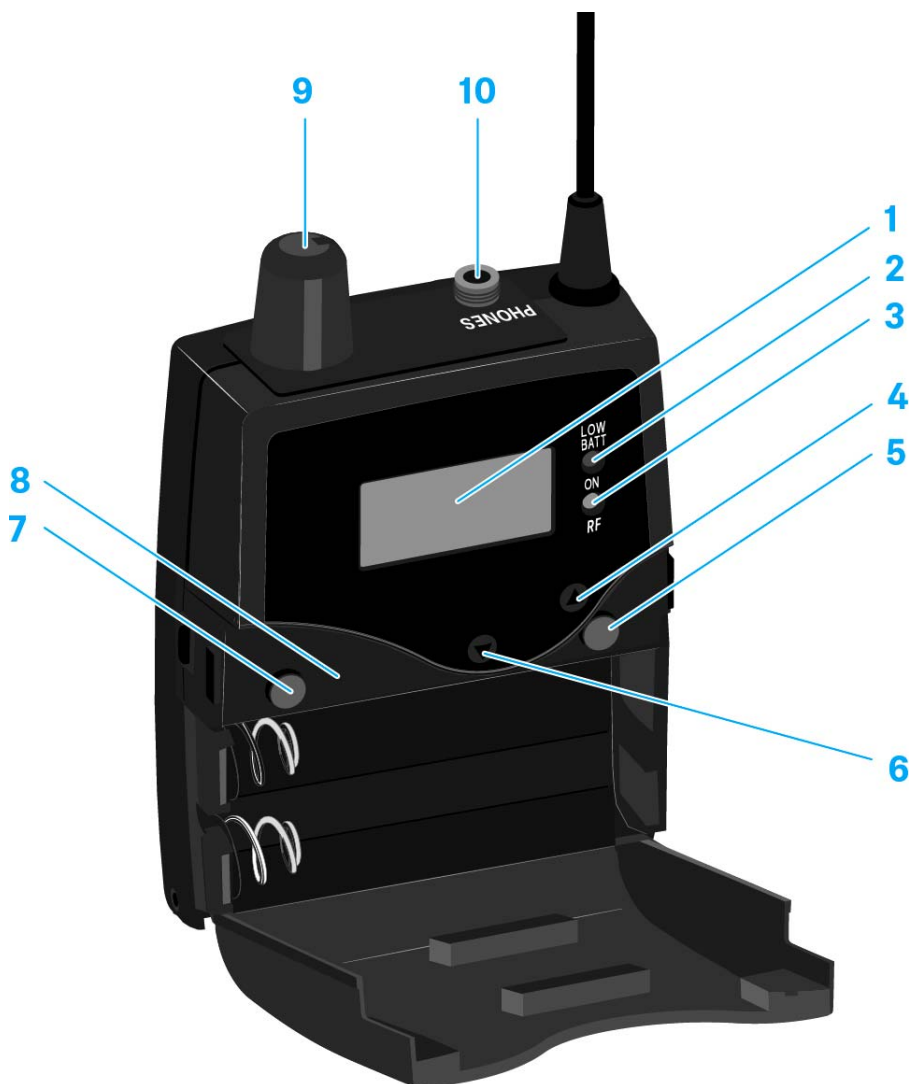

- 1** Display panel
 - See “Displays on the EK IEM G4 display panel”
- 2** Operation and battery indicator, red LED
 - illuminated = ON
See “Switching the EK IEM G4 on and off”
 - flashing = LOW BATTERY
See “Inserting and removing the batteries/rechargeable batteries”
- 3** Wireless reception indicator, green LED
 - illuminated = RF
See “Squelch menu item”
- 4** UP button
 - See “Buttons for navigating through the menu”
- 5** SET button
 - See “Buttons for navigating through the menu”



- 6 DOWN** button
 - See “Buttons for navigating through the menu”
- 7 ESC** button
 - See “Buttons for navigating through the menu”
- 8** Infra-red interface
 - See “Synchronizing devices”
- 9** Volume control with on/off switch
 - See “Connecting earphones to the EK IEM G4”
 - Switch the receiver on/off
 - See “Switching the EK IEM G4 on and off”
- 10** 3.5 mm **PHONES** jack socket, lockable
 - Jack for connecting an earphone
 - See “Connecting earphones to the EK IEM G4”



Switching the EK IEM G4 on and off

To switch the receiver on:

- ▷ Turn the volume control clockwise until it clicks.
The red **ON** LED is illuminated and the **Frequency/Name** standard display appears.



To switch the receiver off:

- ▷ Turn the volume control counterclockwise until it clicks.
The red **ON** LED will go out.



Lock-off function

You can set the automatic lock-off function in the **Auto Lock** menu (see “Auto Lock menu item”).

When you have switched on the lock-off function, you will have to turn the receiver off and on again in order to operate it.

To temporarily deactivate the lock-off function:

- ▷ Press the **SET** button.
Locked appears in the display panel.
- ▷ Press the **UP** or **DOWN** button.
Unlock? appears in the display panel.
- ▷ Press the **SET** button.
Lock-off function is now temporarily deactivated.

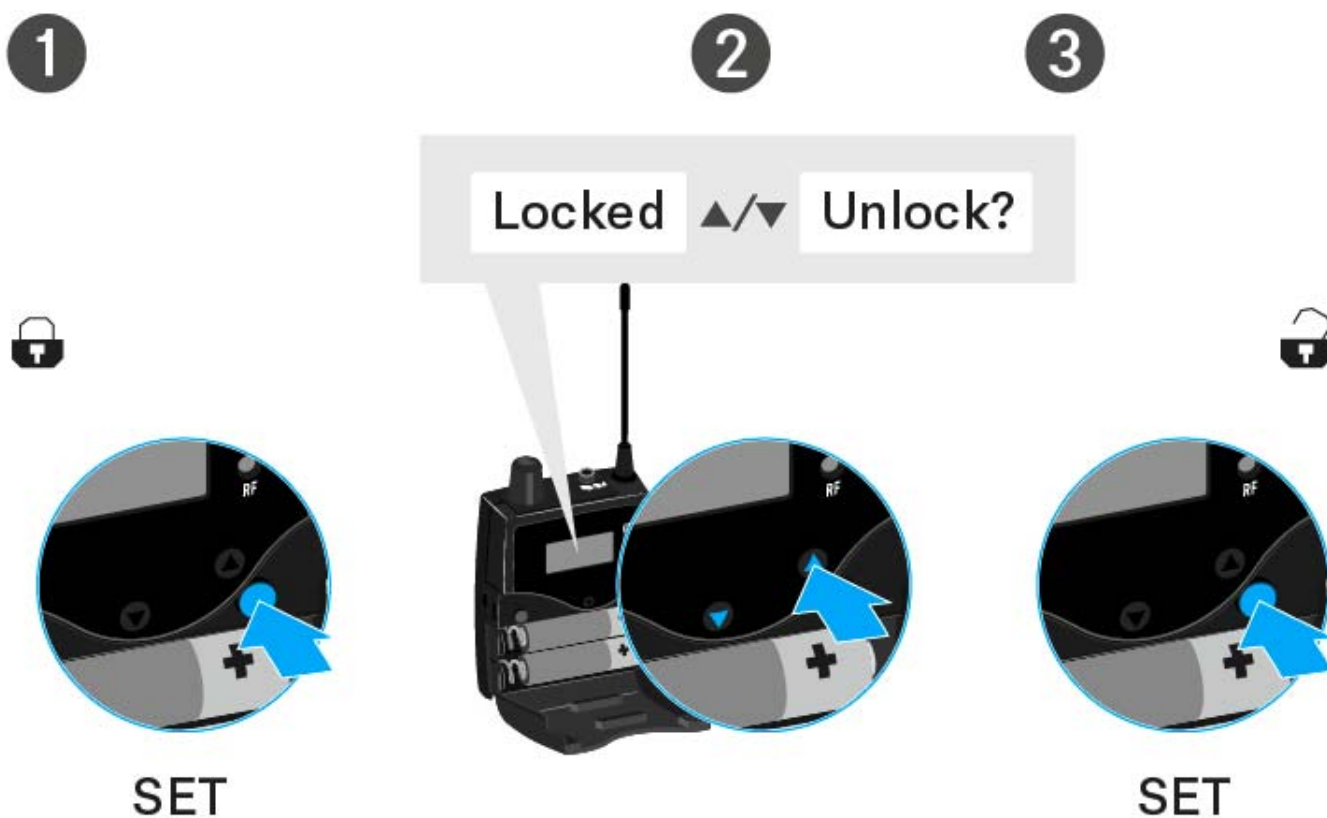

When you are in the operating menu

>> Lock-off function is deactivated long enough for you to work in the operating menu.

When one of the standard displays is shown

>> Lock-off function is automatically activated after 10 seconds.

The lock-off function icon flashes while the lock-off function is being activated again.



Displays on the EK IEM G4 display panel

Status information such as reception quality, battery status, audio level, etc. is displayed on the **home screen** of the display panel. See “Home screen”.

The display panel also displays the **operating menu**, which you can use to configure all of the **settings**. See “Setting options in the menu”.



Buttons for navigating through the menu

To navigate through the EK IEM G4 operating menu, you need the following buttons.

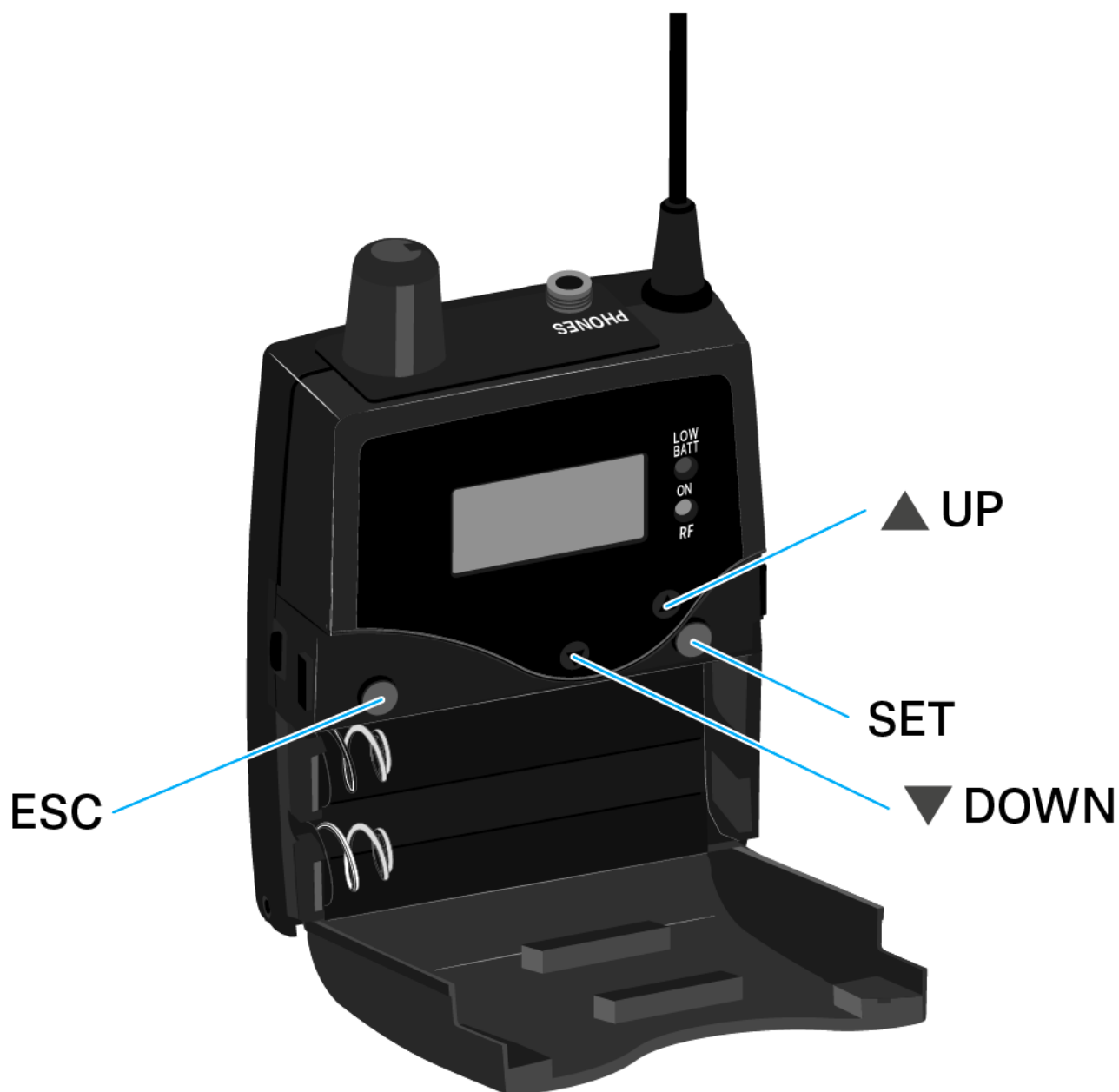

ESC



Press the **ESC** button

- Cancels the entry and returns to the current standard display
- Selects a standard display (see “Home screen”)

**SET**

Press the **SET** button

- Changes from the current standard display to the operating menu
 - Calls up a menu item
 - Changes to a submenu
 - Stores the settings and returns to the operating menu
-



Press the **UP** or **DOWN** button

- Changes to the previous or next menu item
 - Changes the setting of a menu item
 - In Focus mode: Adjusts the balance
 - In Stereo mode: Selects a standard display (see “Home screen”)
-



Home screen

After you switch on the receiver, the display panel initially displays the Sennheiser logo. After a short time, the home screen is then displayed.

The home screen has three different standard displays.

- ▷ On the home screen, press the **ESC** button to switch between the standard displays.

In Stereo mode, you can also press the **UP/DOWN** button to switch between the standard displays.

Frequency/Name standard display

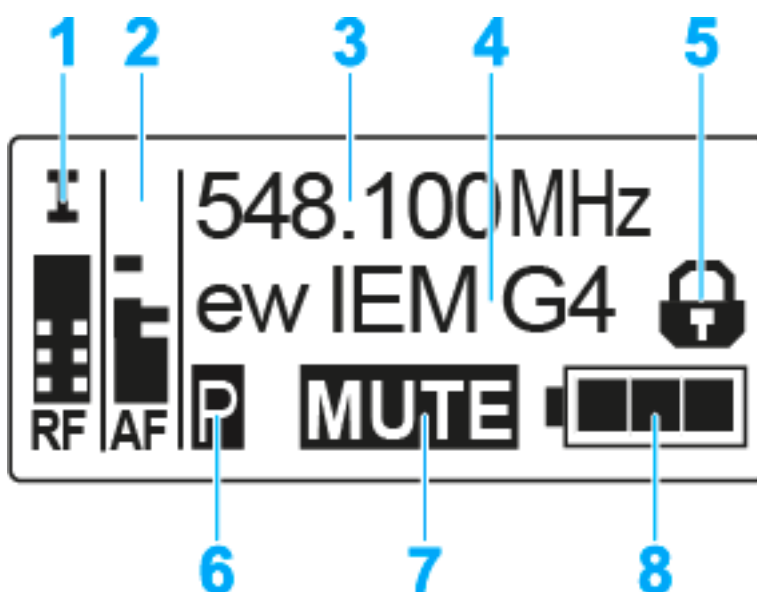

- 1 RF** RF level (radio frequency)
 - RF signal level display
 - including the display of the squelch threshold (see “Squelch menu item”)
- 2 AF** audio level (audio frequency)
 - Displays the audio level of the received transmitter (separated by channel in Stereo mode)
 - When the display shows full deflection, the audio input level is excessively high.
 - See “Balance menu item”
- 3** Frequency
 - Current receiving frequency
 - See “Frequency Preset menu item”
- 4** Name
 - Freely selectable name of the receiver
 - See “Name menu item”
- 5** Lock-off function
 - Lock-off function is activated.
 - See “Lock-off function”
- 6** Battery status



- See “Inserting and removing the batteries/rechargeable batteries”

7 MUTE muting function

- The transmitter’s RF signal is deactivated
See “Deactivating the RF signal (RF mute)”
- or the transmitter is in Mono mode
See “Mode menu item”

8 P pilot tone

- P = Activated pilot tone evaluation
- No symbol = Evaluation is deactivated
- P is black = pilot tone is being received on the current frequency
- See “Advanced -> Limiter menu item”

Bank/Frequency/Limiter standard display

The **Bank/Frequency/Limiter** standard display also shows the audio channel (Stereo/Focus) and the limiter.

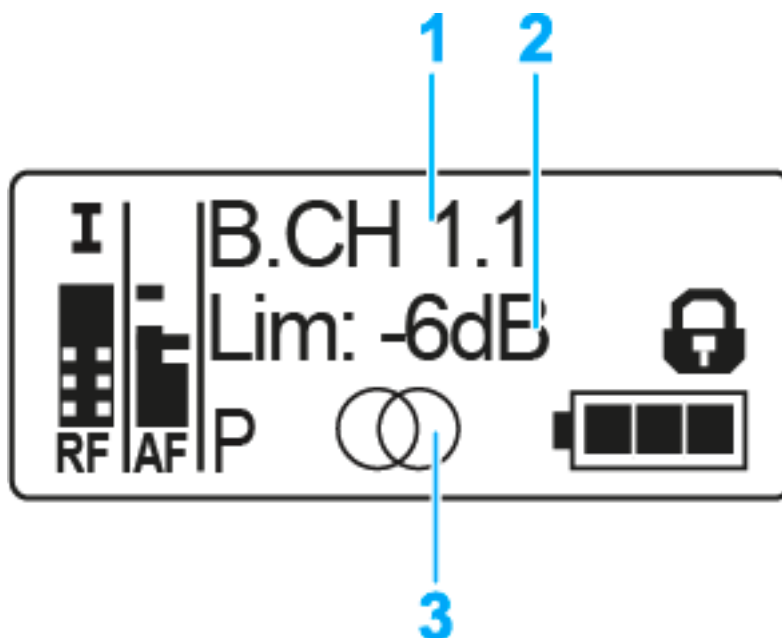

1 Frequency bank and channel

- See “Frequency Preset menu item”

2 Limiter

- See “Advanced -> Limiter menu item”

3 Audio channel, stereo

- Focus: ○○
- See “Mode menu item”



Frequency/High Boost [standard display](#)

The **Frequency/High Boost** standard display also shows the audio channel (Stereo/Focus) and the treble boost.

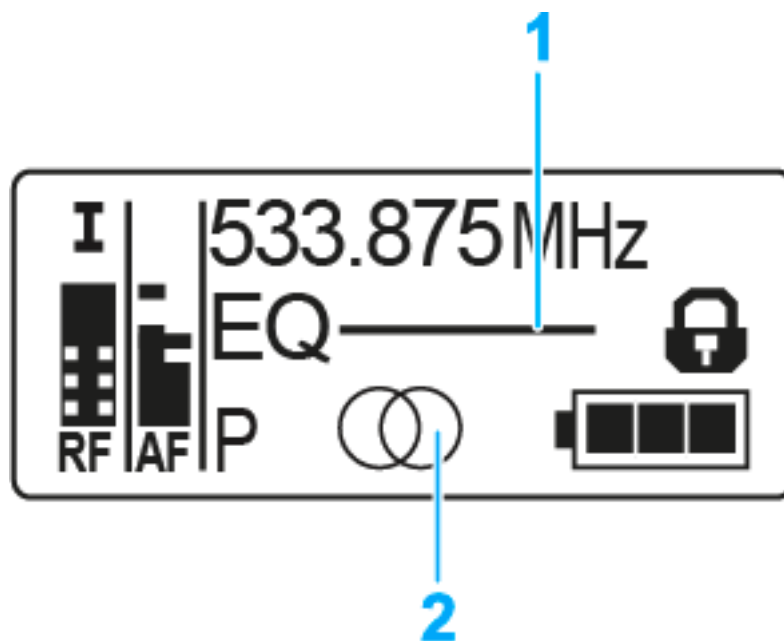

- 1** Treble boost EQ
 - See “High Boost menu item”
- 2** Audio channel, stereo
 - Focus: ○○
 - See “Mode menu item”



Setting options in the menu

In the EK IEM G4 menu, you can configure the following settings.

Adjusting the squelch threshold

- ▷ See “Squelch menu item”

Scanning for unused frequency presets, releases and selects frequency presets

- ▷ See “Easy Setup menu item”

Setting the frequency bank and the channel

- ▷ See “Frequency Preset menu item”

Entering a freely selectable name

- ▷ See “Name menu item”

Adjusting the balance

- ▷ See “Balance menu item”

Adjusting Stereo or Focus mode

- ▷ See “Mode menu item”

Activating/deactivating the treble boost

- ▷ See “High Boost menu item”

Activating/deactivating automatic lock-off function

- ▷ See “Auto Lock menu item”

Configuring enhanced settings in the [Advanced Menu](#):

- Setting the receiving frequencies for the frequency banks U1 to U6
- Adjusting the limiter
- Adjusting the volume boost
- Adjusting the contrast of the display panel



- Adjusting the menu item and loading profiles
- Resetting the settings made in the operating menu
- Displaying the current software revision
- ▷ See “Advanced menu item”

Menu structure

The figure shows the complete EK IEM G4 menu structure in an overview.

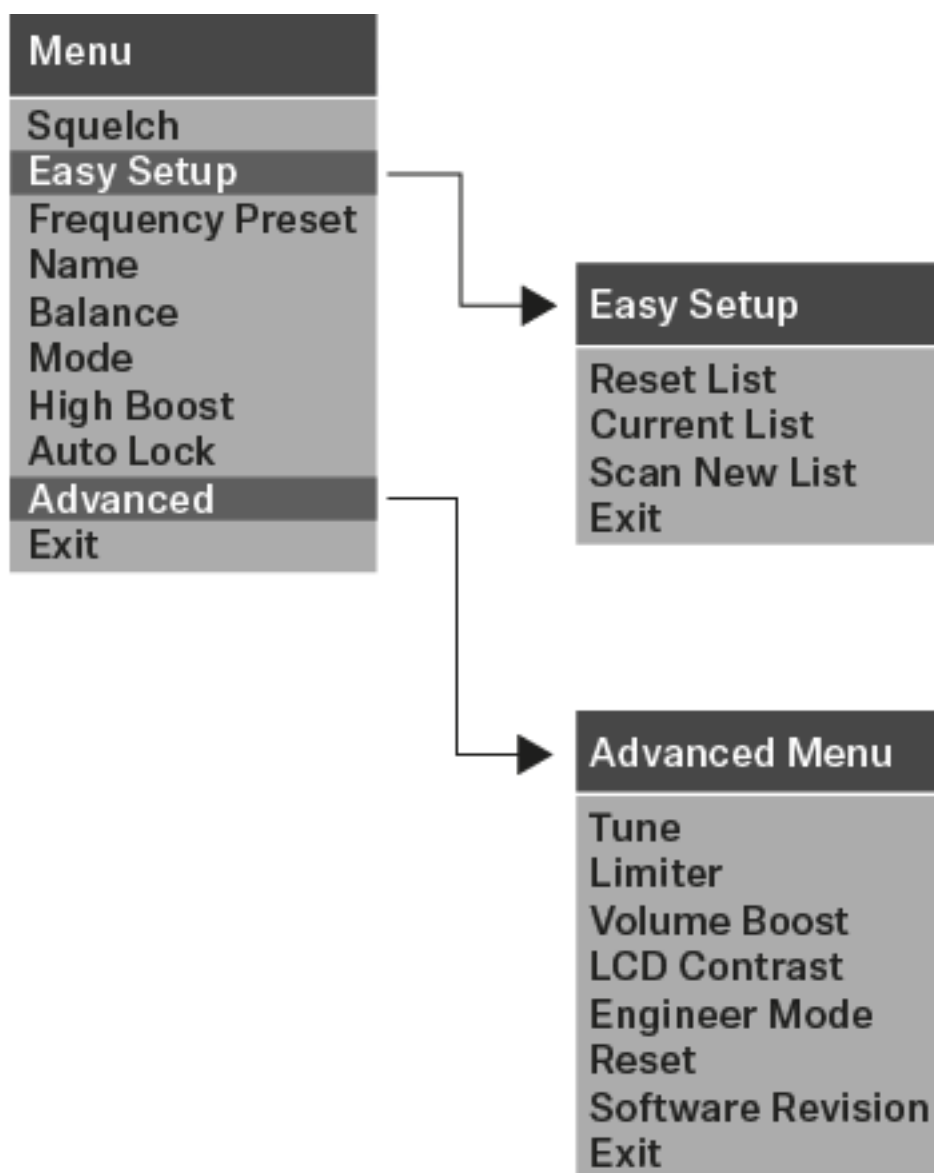



Squelch menu item

You can adjust the squelch threshold in the **Squelch** menu item.

Setting range:

- 5 to 25 dB μ V, adjustable in 2 dB steps

The squelch threshold is displayed on the home screen in the RF signal level area:

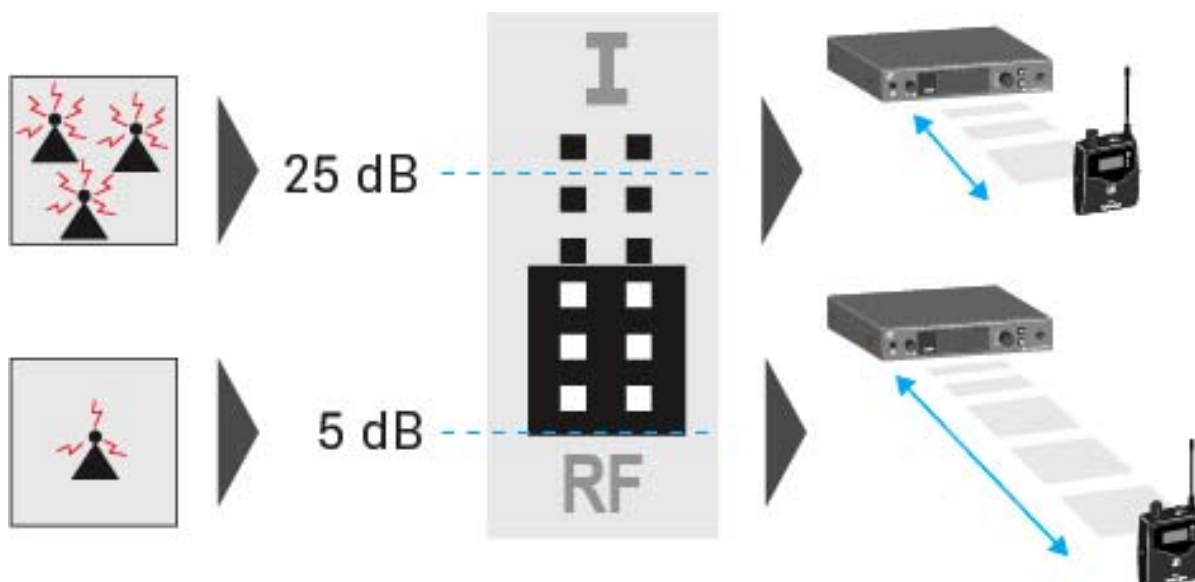

CAUTION

Risk of hearing and material damage

If you set the squelch threshold to a very low value, a very loud hissing noise can occur in the receiver. This hissing noise can be loud enough to cause hearing damage or overload your system's loudspeakers.

- ▷ Before adjusting the squelch threshold, set the volume of the audio output to the minimum.
 - ▷ Never change the squelch threshold during a live transmission.
-



To open the **Squelch** menu item:

- ▷ On the home screen, press the **SET** button to open the operating menu.
- ▷ Press the **UP** or **DOWN** button until the **Squelch** menu item appears in the selection frame.
- ▷ Press the **SET** button to open the menu item.
- ▷ Adjust the settings as desired.

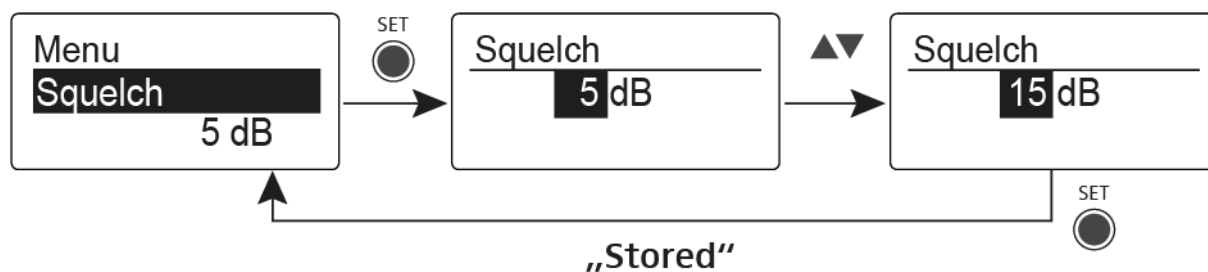

- ▷ Press the **SET** button to save the changes you made to the settings.
or
- ▷ Press the **ESC** button to cancel the entry without saving the settings.



Easy Setup menu item

You can scan for unused frequencies using the **Easy Setup** menu item.



Switch off all transmitters before you perform the scan. If transmitters are still switched on, they are detected as unavailable frequencies and the frequencies that are actually available cannot then be used.

The squelch threshold setting influences the result. Set the squelch threshold to a low level for as many frequencies as possible, and to a high level for as many safe frequencies as possible (see “Squelch menu item”).

To open the **Easy Setup** menu item:

- ▷ Press the **SET** button on the Home Screen to open the operating menu.
- ▷ Press the **UP** or **DOWN** button until the **Easy Setup** menu item appears in the selection frame.
- ▷ Press the **SET** button to open the menu item.
- ▷ Adjust the settings as desired.

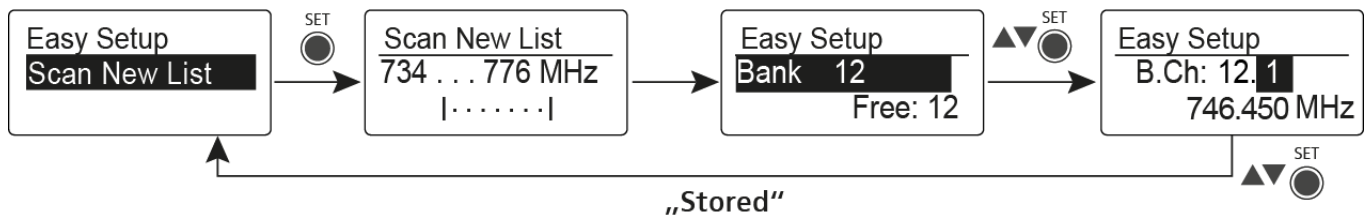

Scan New List

- ▷ Select **Scan New List** to scan for unused frequencies.
- ▷ Press the **SET** button to start the scan.
The frequency range of the receiver is scanned. As a result, the number of unused frequencies is displayed for every frequency bank.
- ▷ Press the **UP** or **DOWN** buttons to select a frequency bank.
- ▷ Press the **SET** button to confirm your selection.
- ▷ Press the **UP** or **DOWN** buttons to select an unused frequency from the selected bank.
- ▷ Press the **SET** button to save the changes you made to the settings.
or
- ▷ Press the **ESC** button to cancel the entry without saving the settings.

Current List

- ▷ Select **Current List** to show the list of unused frequencies from the last scan.



Reset

- ▷ Select **Reset List** to delete the list of unused frequencies.

Performing multi-channel frequency setup

i As an alternative to the following procedure, multi-channel frequency setup can also be performed using the **Sennheiser Wireless Systems Manager (WSM)** software. For more information about controlling devices via the **Sennheiser Wireless Systems Manager (WSM)** software, refer to the instruction manual for the software. You can download the software here:

www.sennheiser.com/wsm

To perform the automatic frequency setup for multiple radio links simultaneously:

- ▷ Connect all of the **SR IEM G4** transmitters to one network using a network switch. See “Creating a data network”.

The automatic frequency setup function only works for transmitters in the same frequency range. Transmitters in a different frequency range are not included.
- ▷ Please note that all transmitters must be in the same **IP address range**.
 - The IP addresses can be **automatically** assigned if there is a DHCP server in the network.
 - If there is no DHCP server in the network, the IP addresses must be assigned **manually**. See “Advanced > IP Address menu item”.
 - Assign the IP addresses for all transmitters in the **192.168.x.x** range (the link-local range **169.254.x.x** is also a possible alternative).



- ▶ Open the **Easy Setup** menu item on one of the transmitters. The **Mute RF For Connected Devices?** message appears.



- ▶ Press the jog dial to confirm the message and deactivate the radio signal for all connected transmitters. All connected transmitters in the same frequency range will switch to **Easy Setup Sync** mode.





- ▷ Perform a **frequency scan** on an **EK IEM G4** portable receiver as described above.



- ▷ From the scan results on the receiver, select a frequency bank with enough free channels.



- ▶ Hold the infrared interface of the **EK IEM G4** receiver in front of the infrared interface of an **SR IEM G4** transmitter to transfer the scan results from the receiver to this transmitter.

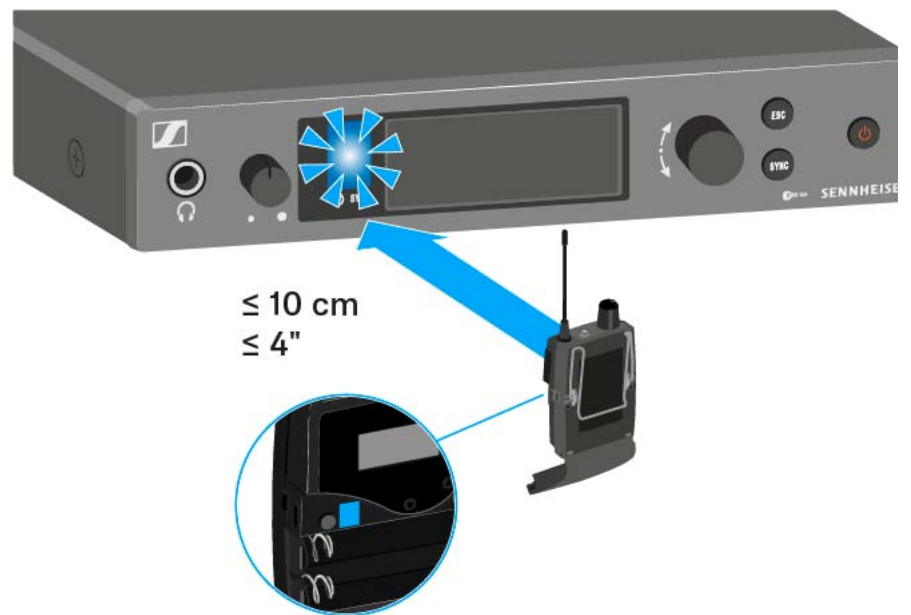

The selected transmitter becomes the **master** transmitter.

The display panels of the other transmitters will display the message [Assign New Frequency?](#)

Receivers with non-compatible frequency ranges will not display a message.





- ▷ Select an unused frequency for one of the connected transmitters on the master transmitter.

The frequency selected on the master transmitter will also be shown on the display panel of the connected transmitters.

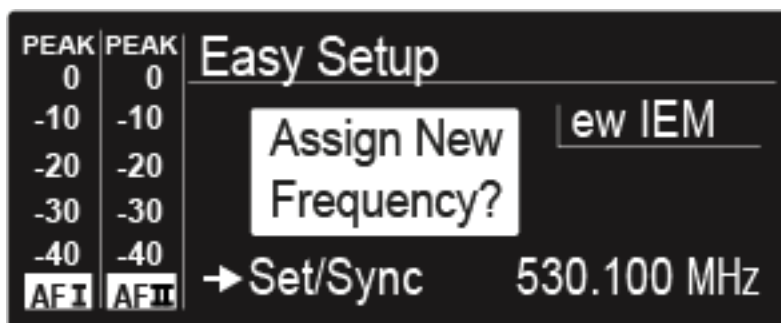

- ▷ Press the jog dial (**SET**) on the particular transmitter to save your selected frequency and synchronize it with the corresponding receiver at a later point (see “Synchronizing devices”).

or

- ▷ Press the **SYNC** button to synchronize the selected frequency with the receiver immediately.
- ▷ Use this procedure to assign an unused frequency to all connected transmitters, one after another.
- ▷ For the last step, assign a frequency to the master transmitter. This completes the multi-channel frequency setup.



Frequency Preset menu item

In the **Frequency Preset** menu item, you can adjust the receiving frequency of the receiver by adjusting the frequency bank and the channel.

To open the **Frequency Preset** menu item:

- ▷ On the home screen, press the **SET** button to open the operating menu.
- ▷ Press the **UP** or **DOWN** button until the **Frequency Preset** menu item appears in the selection frame.
- ▷ Press the **SET** button to open the menu item.
- ▷ Adjust the settings as desired.

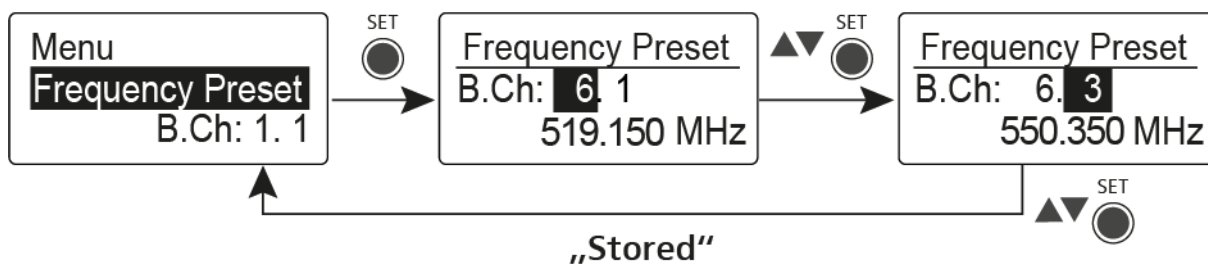

- ▷ Press the **SET** button to save the changes you made to the settings.
or
- ▷ Press the **ESC** button to cancel the entry without saving the settings.

i You can set the frequencies of the frequency bank **U** here: “Advanced -> Tune menu item”.



Name menu item

In the **Name** menu item you can enter a name for the radio link.

To open the **Name** menu item:

- ▷ On the home screen, press the **SET** button to open the operating menu.
- ▷ Press the **UP** or **DOWN** button until the **Name** menu item appears in the selection frame.
- ▷ Press the **SET** button to open the menu item.
- ▷ Adjust the settings as desired.

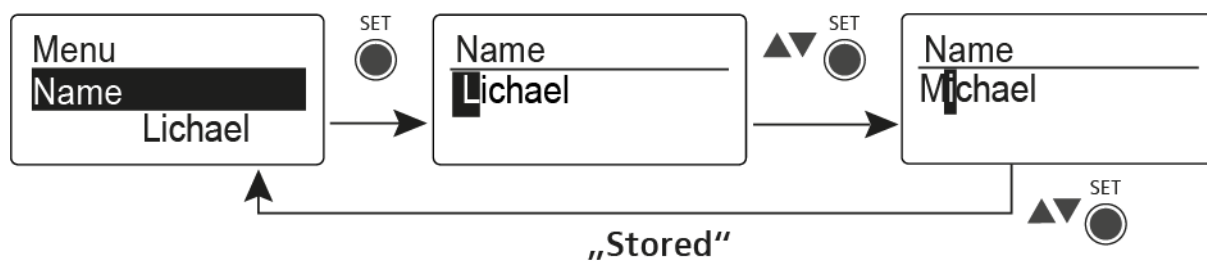

- ▷ Press the **SET** button to save the changes you made to the settings.
or
- ▷ Press the **ESC** button to cancel the entry without saving the settings.



Balance menu item

In the **Balance** menu item you can adjust the balance of the audio channels.

Setting range:

- 31 steps: L = R, L1 to L15 and R1 to R15

To open the **Balance** menu item:

- ▷ On the home screen, press the **SET** button to open the operating menu.
- ▷ Press the **UP** or **DOWN** button until the **Balance** menu item appears in the selection frame.
- ▷ Press the **SET** button to open the menu item.
- ▷ Adjust the settings as desired.

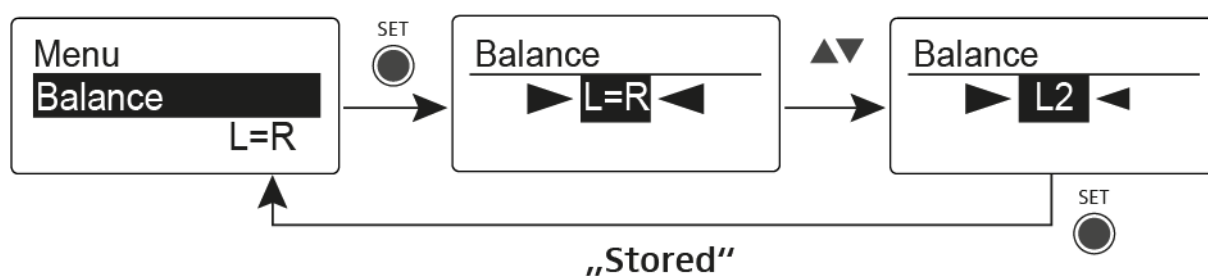

- ▷ Press the **SET** button to save the changes you made to the settings.
or
- ▷ Press the **ESC** button to cancel the entry without saving the settings.



Mode menu item

In the **Mode** menu item you can switch between **Stereo** and **Focus**.

Stereo mode

The left-right signals are available as usual.

The Balance setting serves to adjust the balance between the left and right stereo signal. See “Balance menu item”.

- ▷ To use it, activate **Stereo** mode on the corresponding **SR IEM G4** transmitter. See “Mode menu item”.

Focus mode

The corresponding **SR IEM G4** transmitter operates in **Stereo** mode.

- The left-right signals are mixed and are available as a mono signal in both headphone channels.
- The balance setting serves to adjust the relative levels of the two separate channels in the mixed mono signal. See “Balance menu item”.

The corresponding **SR IEM G4** transmitter operates in **Mono** mode.

- Only the left audio input of the **SR IEM G4** is received as a mono signal.

To open the **Mode** menu item:

- ▷ On the home screen, press the **SET** button to open the operating menu.
- ▷ Press the **UP** or **DOWN** button until the **Mode** menu item appears in the selection frame.
- ▷ Press the **SET** button to open the menu item.
- ▷ Adjust the settings as desired.

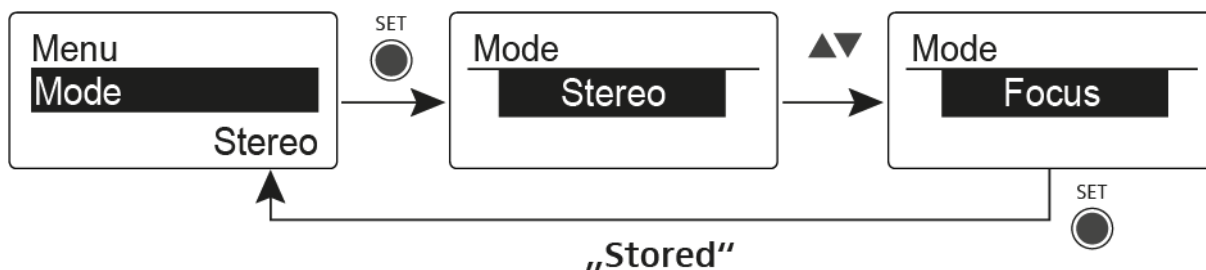

- ▷ Press the **SET** button to save the changes you made to the settings.
or
- ▷ Press the **ESC** button to cancel the entry without saving the settings.



High Boost menu item

In the **High Boost** menu item you can change the treble boost of the output signal.

Setting range:

- 8 dB at 10 kHz

To open the **High Boost** menu item:

- ▷ On the home screen, press the **SET** button to open the operating menu.
- ▷ Press the **UP** or **DOWN** button until the **High Boost** menu item appears in the selection frame.
- ▷ Press the **SET** button to open the menu item.
- ▷ Adjust the settings as desired.

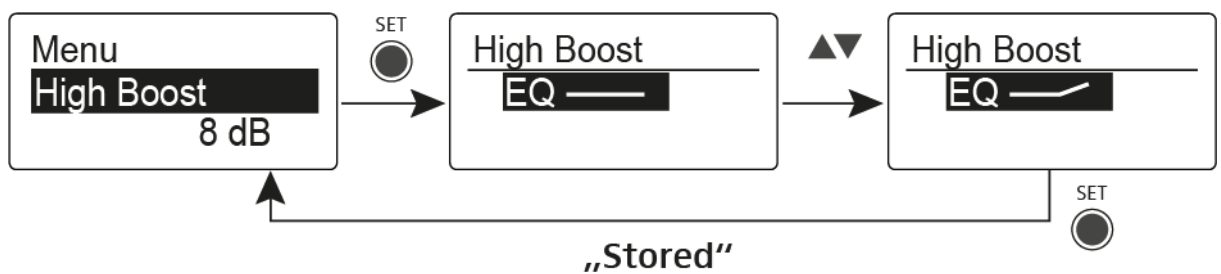

- ▷ Press the **SET** button to save the changes you made to the settings.
or
- ▷ Press the **ESC** button to cancel the entry without saving the settings.



Auto Lock menu item

In the **Auto Lock** menu item you can activate or deactivate the auto lock-off function.

i You can find information about temporarily deactivating the lock-off function during operation under “Lock-off function”.

To open the **Auto Lock** menu item:

- ▷ On the home screen, press the **SET** button to open the operating menu.
- ▷ Press the **UP** or **DOWN** button until the **Auto Lock** menu item appears in the selection frame.
- ▷ Press the **SET** button to open the menu item.
- ▷ Adjust the settings as desired.

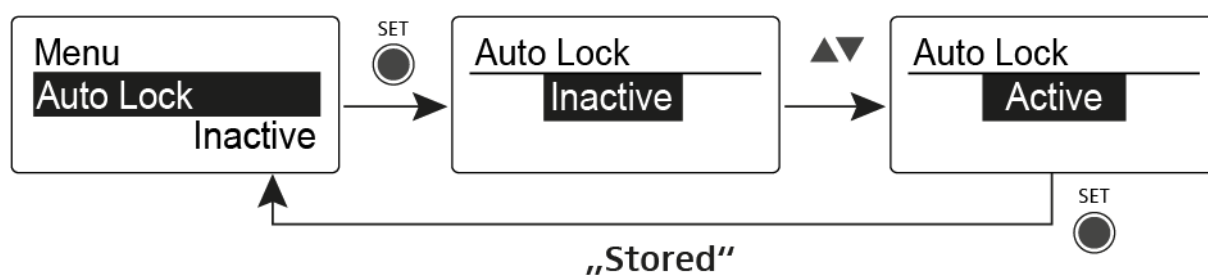

- ▷ Press the **SET** button to save the changes you made to the settings.
or
- ▷ Press the **ESC** button to cancel the entry without saving the settings.



Advanced menu item

In the **Advanced** submenu you can configure enhanced settings.

To open the **Advanced** submenu:

- ▷ On the home screen, press the **SET** button to open the operating menu.
- ▷ Press the **UP** or **DOWN** button until the **Advanced** menu item appears in the selection frame.
- ▷ Press the **SET** button to open the menu item.

The following sub-items are available:

Adjusting the receiving frequency for the frequency bank U

- ▷ See “Advanced -> Tune menu item”

Adjusting the limiter

- ▷ See “Advanced -> Limiter menu item”

Adjusting the volume boost

- ▷ See “Advanced -> Volume Boost menu item”

Adjusting the contrast of the display panel

- ▷ See “Advanced -> LCD Contrast menu item”

Adjusting the menu item and loading profiles

- ▷ See “Advanced -> Engineer Mode menu item”

Resetting the receiver

- ▷ See “Advanced -> Reset menu item”

Displaying the current software revision

- ▷ See “Advanced -> Software Revision menu item”
-



Advanced -> Tune menu item

In the **Tune** menu item of the **Advanced** submenu, you can configure the receiving frequencies for the frequency banks **U1** to **U6**.

You can save a total of 16 frequencies in every **U** frequency bank.

Only adjusting the frequency

- ▷ Open the **Tune** menu item in the **Advanced** menu.
- ▷ Adjust the settings.

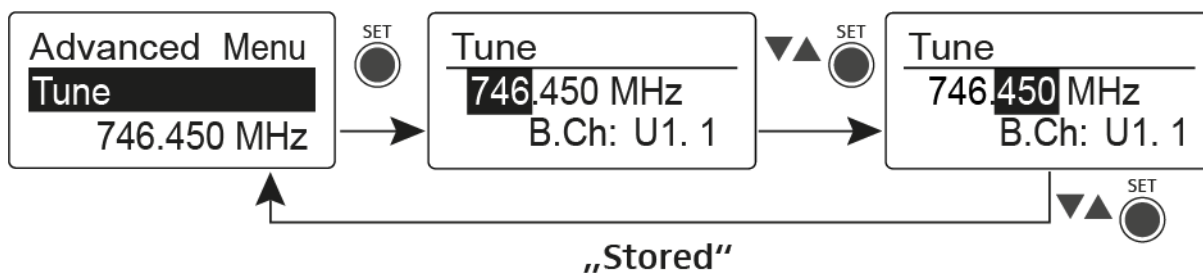

- ▷ Press the **SET** button to save the changes you made to the settings.
or
- ▷ Press the **ESC** button to cancel the entry without saving the settings.

Setting the channel and frequency

- ▷ Select the **Tune** menu item and call it up by holding down the **SET** button until the channel selection appears.
- ▷ Adjust the settings.

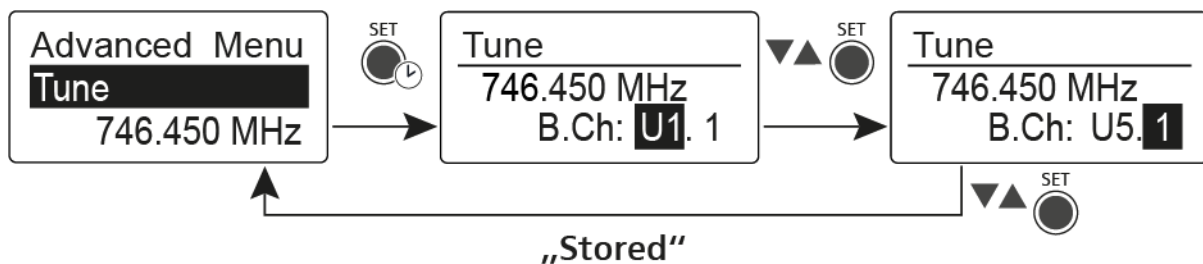

- ▷ Press the **SET** button to save the changes you made to the settings.
or
- ▷ Press the **ESC** button to cancel the entry without saving the settings.



Advanced -> Limiter menu item

In the **Limiter** menu item of the **Advanced** submenu, you can adjust the volume of the headphone output **PHONES**.

Setting range:

- Off
- -18 dB, -12 dB or -6 dB

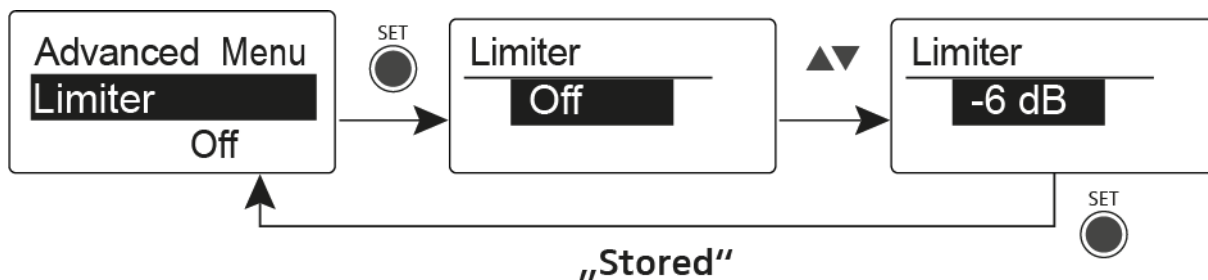

CAUTION

Risk of hearing damage

The limiter limits the volume of the headphone output **PHONES** and thus protects your hearing. When the limiter is switched off, you may expose yourself to high volumes over a prolonged period which can cause permanent hearing damage.

- ▷ Set the limiter to the lowest level before putting the earphones on.
 - ▷ Do not continuously expose yourself to high volume levels.
-



Advanced -> Volume Boost menu item

In the **Volume Boost** menu item of the **Advanced** submenu, you can adjust the volume boost.

Setting range:

- 0 dB, +3 dB or +6 dB

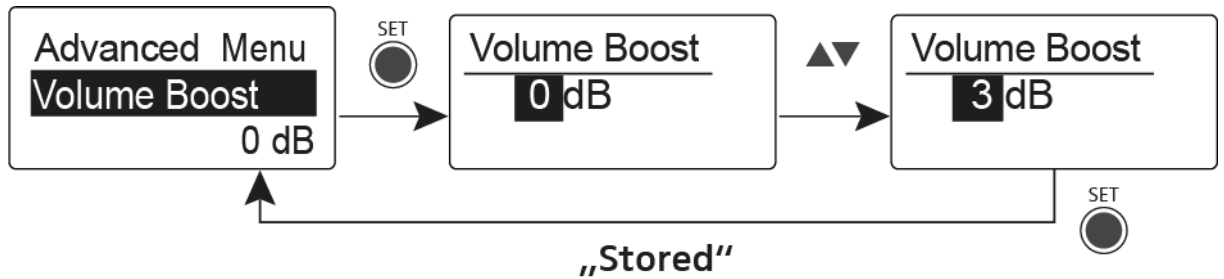

i When configuring the settings, ensure that the audio signal is not distorted.

Advanced -> LCD Contrast menu item

In the **LCD Contrast** menu item of the **Advanced** submenu, you can adjust the display contrast of the display panel.





Advanced -> Engineer Mode menu item

In the **Engineer Mode** menu item of the **Advanced** submenu, you can configure the menu items and upload profiles.

In Engineer Mode, you can use your EK IEM G4 to read out settings from other EK receivers and save them as profiles.

You can load these profiles during a live transmission in order to monitor and, if necessary, adjust an audio signal reproduced by a read-out EK receiver.

A profile contains the settings of the menu items: “Squelch menu item”, “Frequency Preset menu item”, “Name menu item”, “Balance menu item”, “Mode menu item”, “High Boost menu item”, “Advanced -> Tune menu item”, “Advanced -> Limiter menu item” and “Advanced -> Volume Boost menu item”.

Profiles List menu item

- Create up to 16 profiles and read out the settings of the different EK receivers.

Load Profiles menu item

- Activate/deactivate profile loading

Clear List menu item

- Delete all profiles

Profiles List

To read out settings and save them as a profile:

- ▷ Call up the **Engineer Mode** menu item in the Advanced menu.
- ▷ Call up the **Profiles List** menu item.
- ▷ Select an unused profile (a profile without a frequency entry).
- ▷ Press the **SET** button.
 - Sync** appears on the display panel of the receiver.
- ▷ Place the receiver’s infra-red interface in front of the infra-red interface of another EK receiver.
 - The settings of the receiver are assigned to the selected profile.
- ▷ Repeat this procedure to create profiles of other EK receivers.

i You can read out the data of an SR IEM transmitter in the same way. Please note, however, that these settings will only be up-to-date if transmitter and receiver have been synchronized before (“Synchronizing devices”).

When the factory default settings are restored (“Advanced -> Reset menu item”), all profiles are deleted.



Load Profiles

To select a saved profile:

- ▷ Call up the **Load Profiles** menu item in the Engineer Mode submenu.
- ▷ Select **Active** to activate the loading of the profiles.
E appears on the standard display.
- ▷ Press the **ESC** button to exit the menu item.
- ▷ Select a profile by pressing the **UP/DOWN** button on the standard display.

The selected profile is loaded; you hear the audio signal of the corresponding receiver.

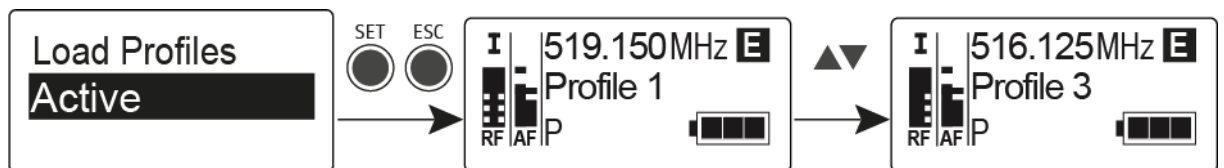

i If there is no profile saved, **Inactive** appears in the **Load Profiles** menu item.

Engineer Mode remains activated, even if you replace the batteries or switch the EK off and on again.



Advanced -> Reset menu item

In the **Reset** menu item of the **Advanced** submenu, you can reset the settings of the receiver to the factory settings.

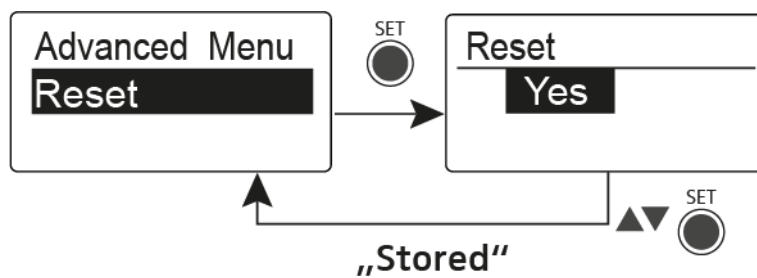

Advanced -> Software Revision menu item

In the **Software Revision** menu item of the **Advanced** submenu, you can display the current software version of the receiver.



Using the SR IEM G4

These sections contain detailed information about using the SR IEM G4.

You can find information on installation and startup of the SR IEM G4 under “Installing the SR IEM G4”.



Operating elements of the SR IEM G4 transmitter

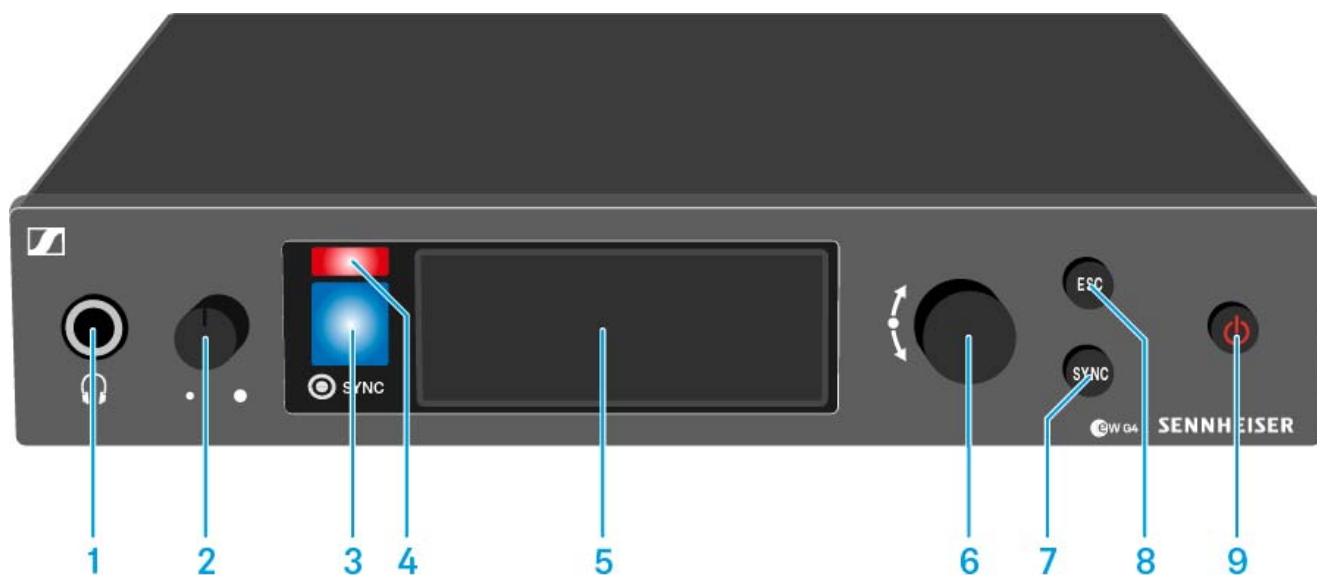

- 1** Headphone socket
 - See “Using the headphone output”
- 2** Volume control for the headphone socket
 - See “Using the headphone output”
- 3** Infrared interface with a blue LED
 - See “Synchronizing devices”
- 4** Red LED for warnings
 - See “Advanced > Fullscreen Warnings menu item”
- 5** Display panel
 - See “Displays on the SR IEM G4 display panel”
- 6** **Jog dial** for navigating through the menu
 - See “Buttons for navigating the SR IEM G4 menu”
- 7** **SYNC** button
 - See “Synchronizing devices”
- 8** **ESC** button
 - See “Buttons for navigating the SR IEM G4 menu”
- 9** **STANDBY** button
 - See “Switching the SR IEM G4 on and off”



Switching the SR IEM G4 on and off

To **switch on** the transmitter:

- ▷ Short-press the **STANDBY** button.
The transmitter switches on and the standard display appears.



To switch the transmitter to **standby mode**:

- ▷ If necessary, deactivate the lock-off function (see “Lock-off function”).
- ▷ Press and hold the **STANDBY** button until **OFF** appears on the display panel.
The display panel switches off.

To **completely switch** the transmitter **off**:

- ▷ Disconnect the transmitter from the power supply system by unplugging the power supply unit from the wall socket.



Using the headphone output

You can use the headphone output on the front of the SR IEM G4 (6.3 mm jack) to listen to the audio signal.

ATTENTION



Danger due to high volume levels

Volume levels that are too high may damage your hearing.

- ▷ Turn down the volume of the headphone output before you put on the headphone.
-
- ▷ Connect the headphone to the headphone socket.
 - ▷ Control the volume by turning the volume control next to the headphone socket.

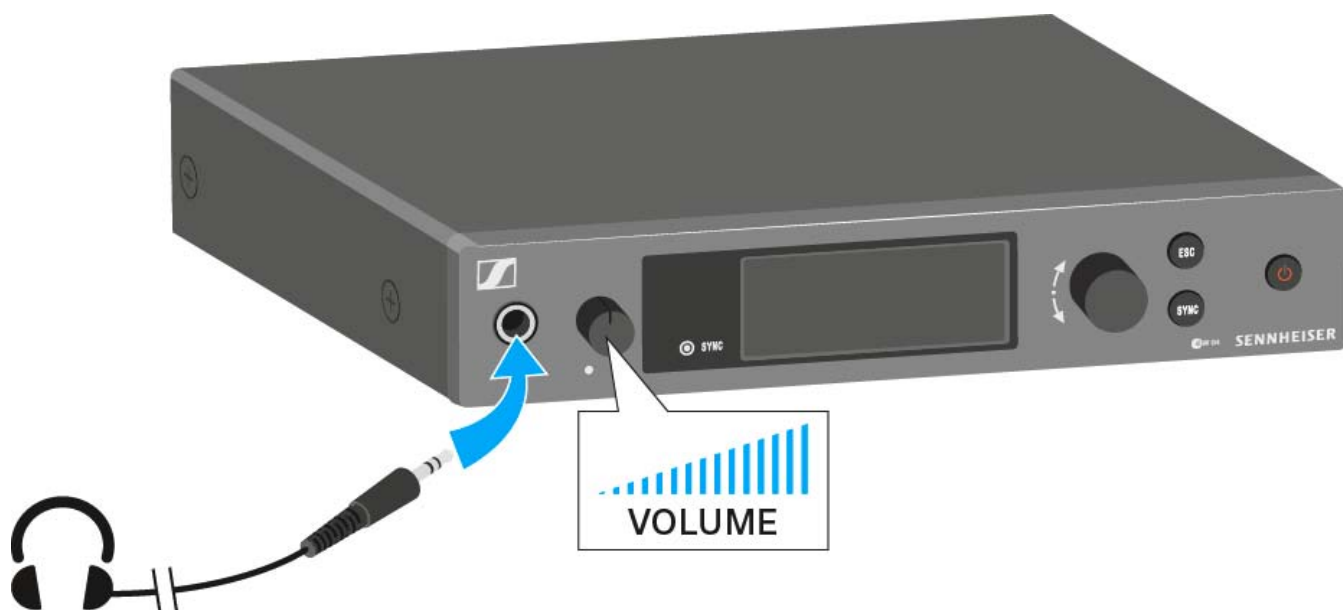



Configuring the audio channels (mono/stereo)

You can configure audio channels in the “Mode menu item”. You can select either **Stereo** or **Mono**:

- Select **Stereo** when you want to send a separate audio signal on channel I and channel II (e.g. channel I = audio signal of the moderator/musician, channel II = sum of all audio signals).

The moderator/musician then has the option to adjust the volume distribution on his or her receiver as needed.

i In Stereo mode, you can receive the two input signals either as a mixed mono signal or as a stereo signal. To do so, you must select Focus or Stereo mode on the EK IEM G4 receiver. See “Mode menu item”.

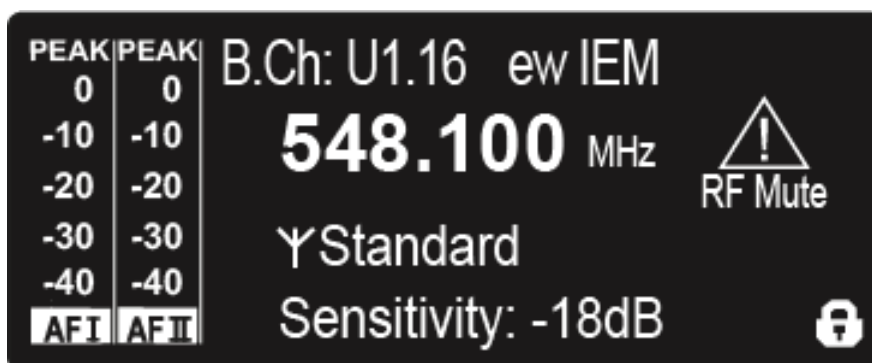

- Select **Mono** when you only want to transmit one channel. The signal of the left audio input **BAL AF IN L** is used.

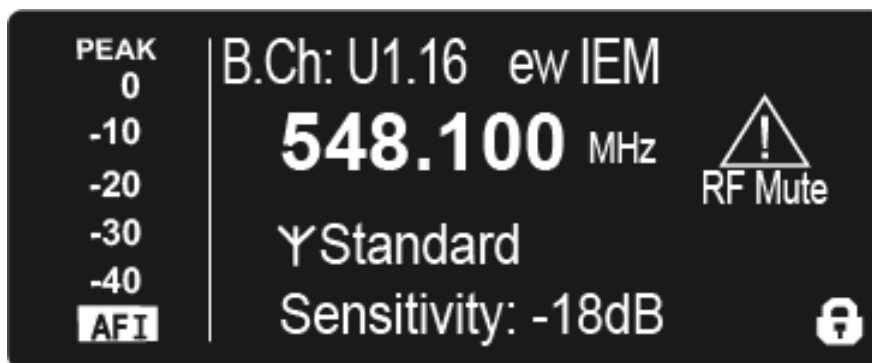

i In Mono mode, you have to deactivate the pilot tone evaluation on your EK IEM G4 receiver. This is the only way to ensure that your receivers will transmit the same signal on channel I and channel II.



Deactivating the RF signal (RF mute)

To **deactivate** the **RF signal**:

- ▷ Press the **STANDBY** button.
RF Mute Off? appears in the display panel.
- ▷ Turn the **jog dial**.
RF Mute ON? appears in the display panel.
- ▷ Press the jog dial.

The transmission frequency is displayed, however the transmitter is not transmitting an RF signal. The **RF Mute** warning appears (see “Displays on the SR IEM G4 display panel”) and the LED warnings are illuminated (see “Operating elements of the SR IEM G4 transmitter”).

To **activate** the **RF signal**:

- ▷ Press the **STANDBY** button.
RF Mute Off? appears in the display panel.
- ▷ Turn the **jog dial**.
RF Mute ON? appears in the display panel.
- ▷ Press the **jog dial**.

The warning in the display and the LED warnings go out.

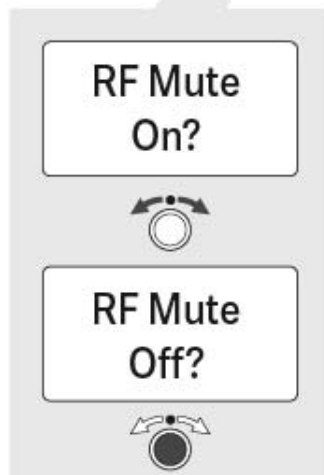



Lock-off function

You can set the automatic lock-off function in the **Auto lock** menu (see “Auto Lock menu item”).

When you have switched on the lock-off function, you will have to turn the transmitter off and on again in order to operate it.

To temporarily deactivate the lock-off function:

- ▷ Press the **jog dial**.
Locked appears in the display panel.
- ▷ Turn the **jog dial**.
Unlock? appears in the display panel.
- ▷ Press the **jog dial**.
Lock-off function is now temporarily deactivated.

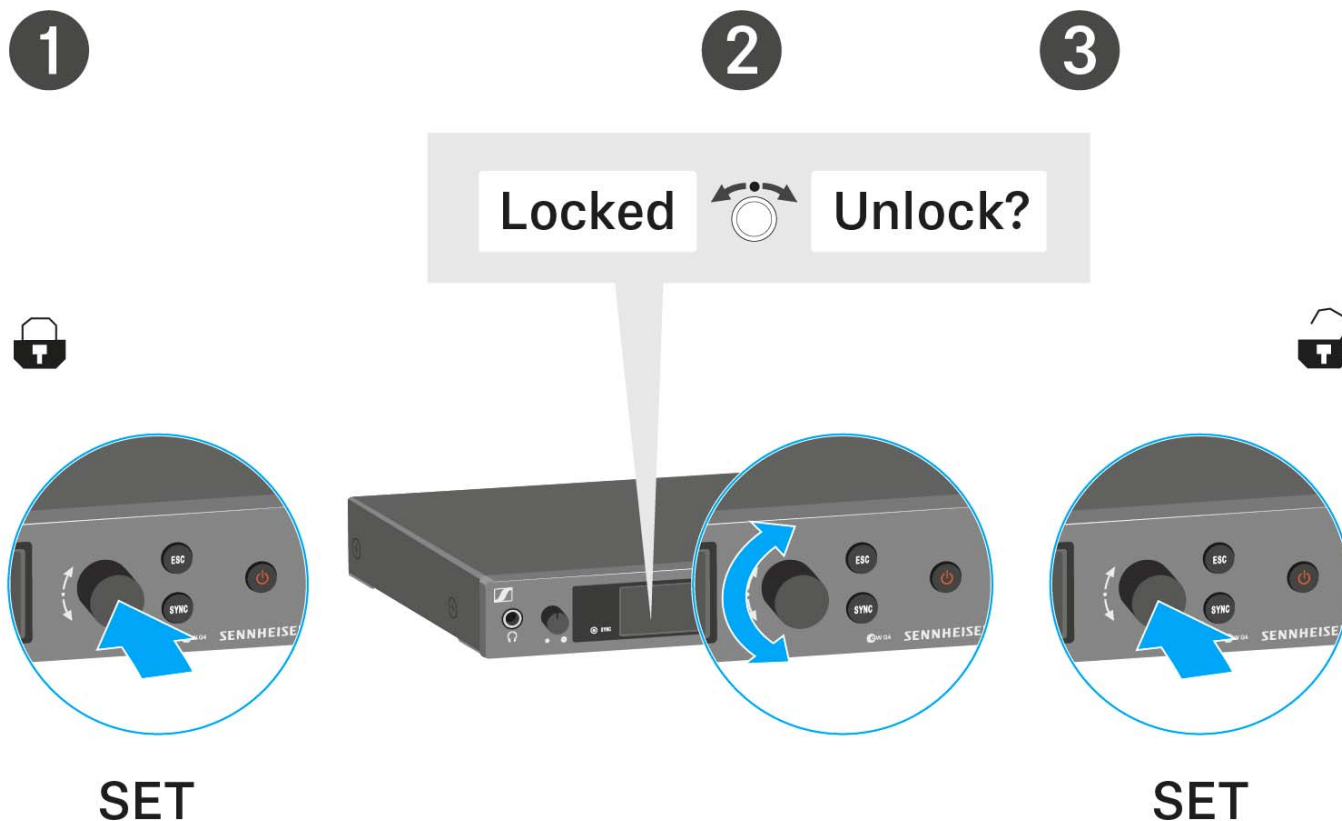

When you are in the operating menu

>> Lock-off function is deactivated long enough for you to work in the operating menu.

You are in the standard display

>> Lock-off function is automatically activated after 10 seconds.

The Lock-off function icon flashes while the lock-off function is being activated again.



Displays on the SR IEM G4 display panel

You can view the following information on the transmitter display.

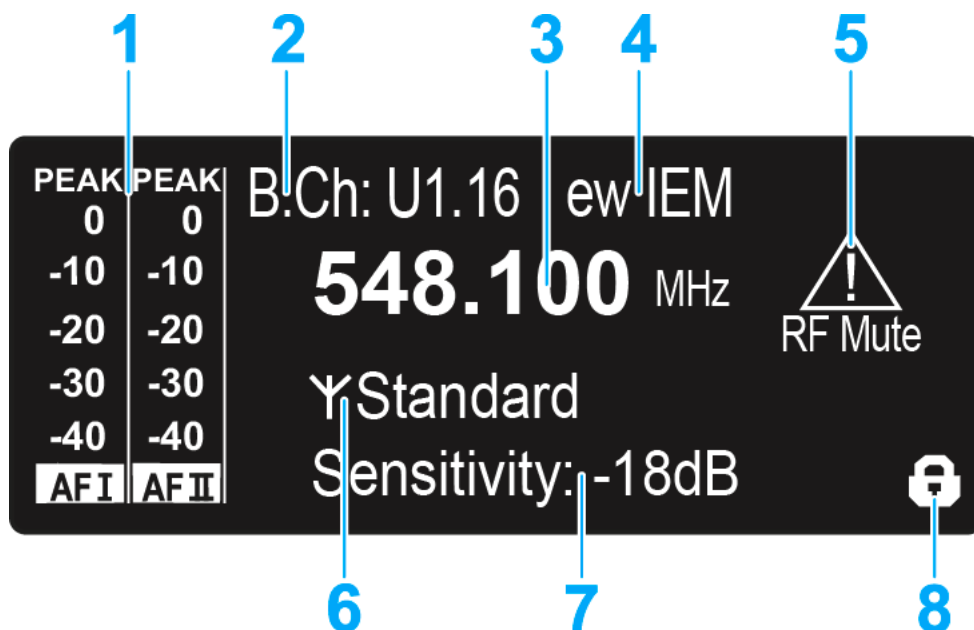

1 AF audio level (audio frequency)

- Audio channel level with peak hold function
When the display shows full deflection, the audio input level is excessively high. When the transmitter is overloaded frequently or for extended periods of time, the **PEAK** display is shown inverted.
- See “Sensitivity menu item”
- See “Configuring the audio channels (mono/stereo)”

2 Frequency bank and channel

- Current frequency bank and channel number
- See “Frequency Preset menu item”

3 Frequency

- Configured transmission frequency
- See “Frequency Preset menu item”

4 Name

- Freely selectable name of the receiver
- See “Name menu item”

5 Warnings

- Activated warning messages are displayed
- See “Advanced > Fullscreen Warnings menu item”

6 Transmission icon and transmission power

- RF signal is being transmitted
- See “Advanced > RF Power menu item”
- See “Deactivating the RF signal (RF mute)”

7 Input sensitivity

- Configured input sensitivity for the NF signal on the audio input sockets **BAL AF IN L (I)** and **BAL AF IN R (II)**
- See “Sensitivity menu item”



8 Lock-off function

- Lock-off function is activated.
- See “Auto Lock menu item”

>> “Buttons for navigating the SR IEM G4 menu”

>> “Setting options in the menu”

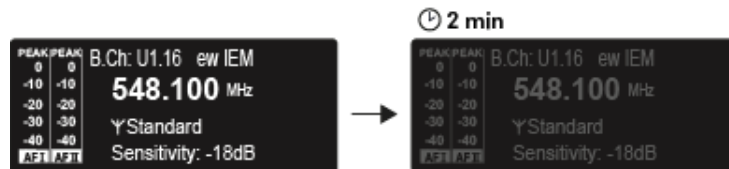

The display is dimmed automatically after 2 minutes of inactivity.



If there is no radio link to a transmitter, the display switches off after 20 minutes. The display can be reactivated by pressing any button.



Buttons for navigating the SR IEM G4 menu

Navigating through the menu

To open the menu:

- ▷ Press the **jog dial**.

The operating menu is shown on the transmitter display panel.

To open a menu item:

- ▷ Turn the **jog dial** to navigate through the individual menu items.
- ▷ Press the **jog dial** to open the selected menu item.

 “Operating elements of the SR IEM G4 transmitter”

Making changes in a menu item

After you open a menu item, you can make changes as follows:

- ▷ Turn the **jog dial** to set the displayed value.
- ▷ Press the **jog dial** to save your setting.
- ▷ Press the **ESC** button to leave the menu item without saving the setting.

 “Operating elements of the SR IEM G4 transmitter”

>> “Displays on the SR IEM G4 display panel”

>> “Setting options in the menu”



Setting options in the menu

In the SR IEM G4 menu, you can configure the following settings.

Adjusting the input sensitivity

- ▷ See “Sensitivity menu item”

Configuring the audio transmission mode (mono/stereo)

- ▷ See “Mode menu item”

Activating Easy Setup Sync

- ▷ See “Easy Setup menu item”

Setting the frequency bank and the channel

- ▷ See “Frequency Preset menu item”

Entering a freely selectable name

- ▷ See “Name menu item”

Activating/deactivating the automatic lock-off function

- ▷ See “Auto Lock menu item”

Configuring enhanced settings in the [Advanced Menu](#):

- Adjusting the transmission frequencies for the U frequency bank
 - Adjusting the parameters for transmission to the receivers
 - Configuring the transmission power
 - Adjusting the warnings
 - Adjusting the contrast of the display panel
 - Resetting the transmitter
 - Configuring the IP address
 - Displaying the current software revision
 - ▷ See “Advanced menu item”
-



Sensitivity menu item

- Adjusting the input sensitivity – AF audio level

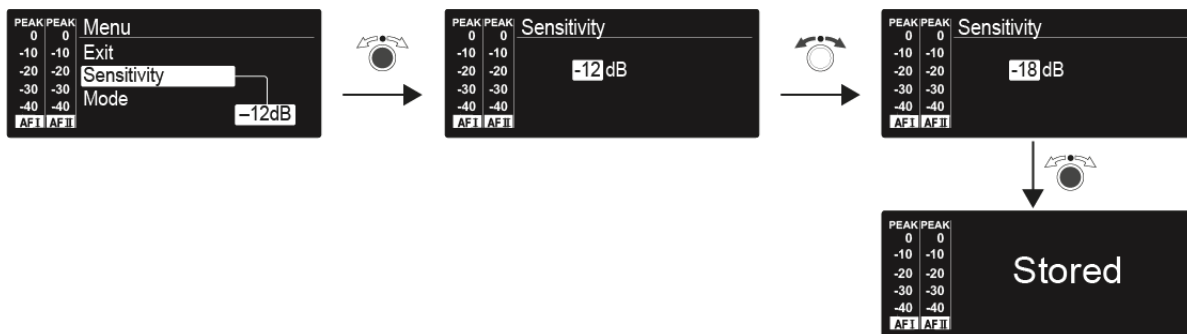

Setting range: 0 dB to –42 dB in 3 dB steps

Mode menu item

- Configuring the audio transmission

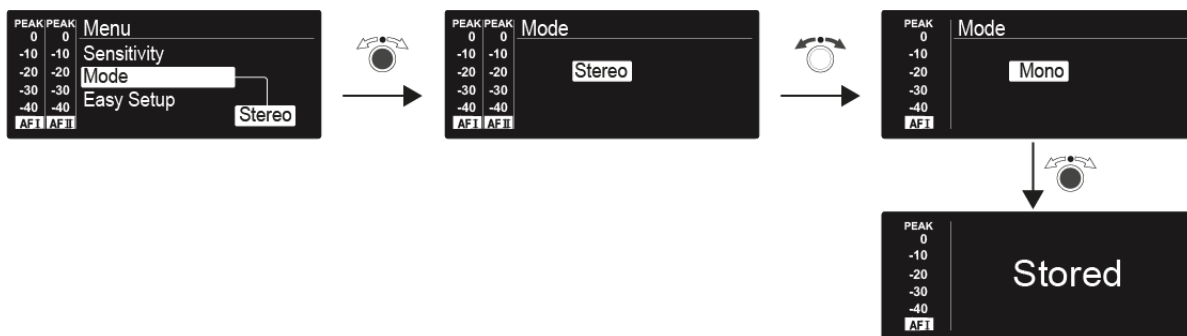

Setting range: Stereo and Mono

i In stereo mode, you can receive the two input signals either as a mixed mono signal or as a stereo signal. To do so, you must select Focus or Stereo mode on the EK IEM G4 receiver. See “Mode menu item”.

Easy Setup menu item

- Activating Easy Setup Sync

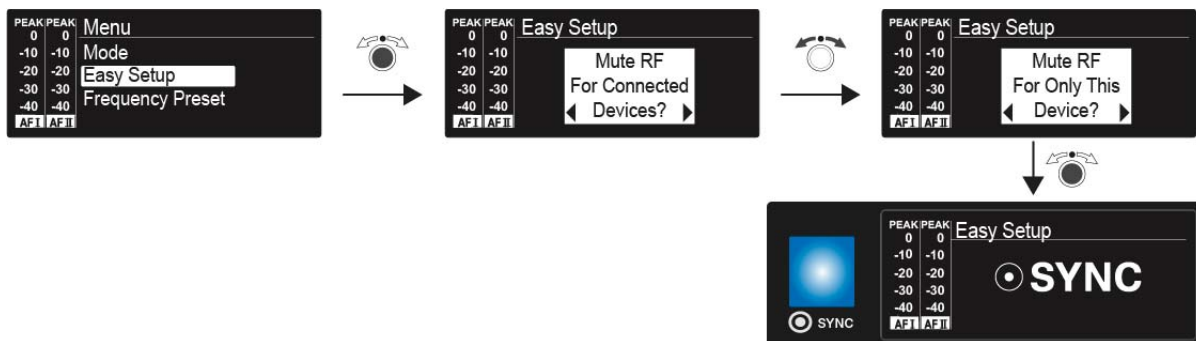

The **Easy Setup Sync** function is needed to perform a frequency scan using the receiver and for automatic multi-channel frequency setup.

- See “Easy Setup menu item” for the EK IEM G4 receiver.
- See “Synchronizing devices”.



Frequency Preset menu item

- Manually selecting a frequency bank and channel

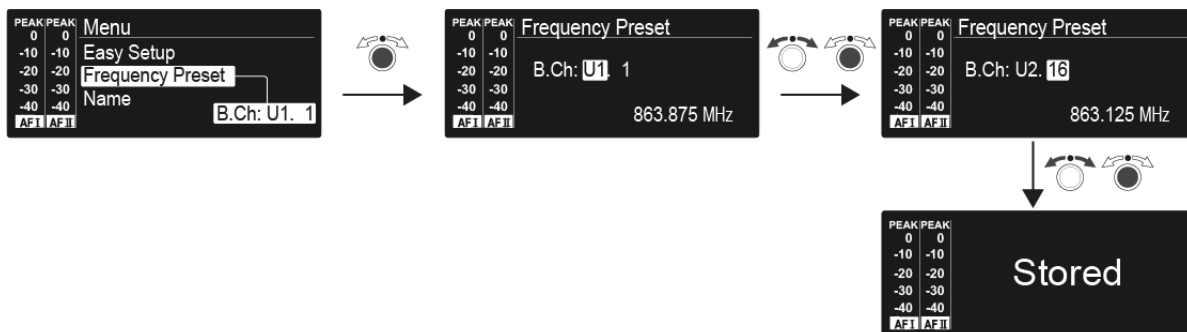

Name menu item

- Entering names



In the **Name** menu item you can enter any name you want for the transmitters (e.g. the names of the musicians).

The names are a maximum of 8 characters:

- All letters except umlauts.
- Numbers from 0 to 9
- Special characters and spaces

Enter the names as follows:

- ▷ Turn the jog dial to select a character.
- ▷ Press the jog dial to switch to the next position.

Once you have entered the last character, press the jog dial to save the name.



Auto Lock menu item

- Switching the automatic lock-off function on and off

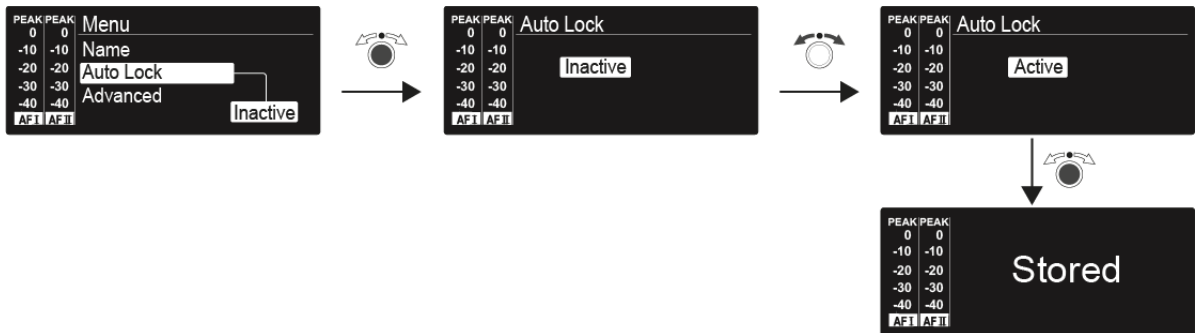

This lock prevents the transmitter from being unintentionally switched off and also prevents any unintentional changes to the transmitter's configuration. In the standard display, the lock icon shows whether the lock-off function is currently switched on.

You can find information about using the lock-off function under "Lock-off function".



Advanced menu item

In the **Advanced** submenu you can configure enhanced settings.

The following sub-items are available:

Adjusting the transmission frequencies for the U frequency bank

- ▷ See “Advanced > Tune menu item”

Adjusting the parameters for transmission to the receivers

- ▷ See “Advanced > Sync Settings menu item”

Configuring the transmission power

- ▷ See “Advanced > RF Power menu item”

Adjusting the warnings

- ▷ See “Advanced > Fullscreen Warnings menu item”

Adjusting the contrast of the display panel

- ▷ See “Advanced > Brightness menu item”

Resetting the transmitter

- ▷ See “Advanced > Reset menu item”

Configuring the IP address

- ▷ See “Advanced > IP Address menu item”

Displaying the current software revision

- ▷ See “Advanced > Software Revision menu item”
-



Advanced > Tune menu item

- Configuring transmission frequencies and frequency banks **U1** to **U6**
- You can save a total of 16 channels in the frequency banks **U1** to **U6**.

Only adjusting the frequency

- ▷ Open the **Tune** menu item in the **Advanced** menu.
- ▷ Adjust the settings.

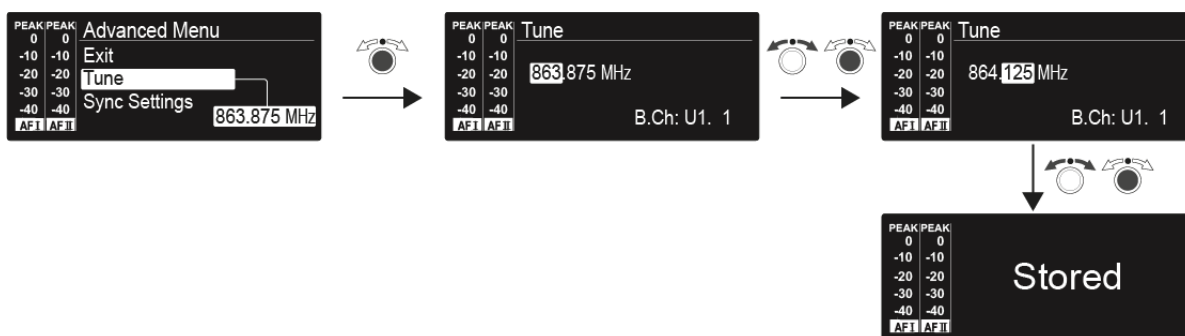

Setting the channel and frequency

- ▷ Select the **Tune** menu item and call it up by holding down the jog dial until the channel selection appears.
- ▷ Adjust the settings.

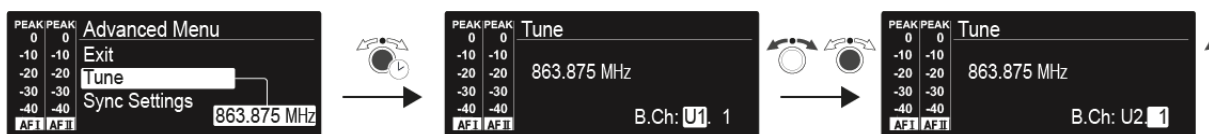



Advanced > Sync Settings menu item

- Configuring, activating or deactivating parameters for transmission to the receivers

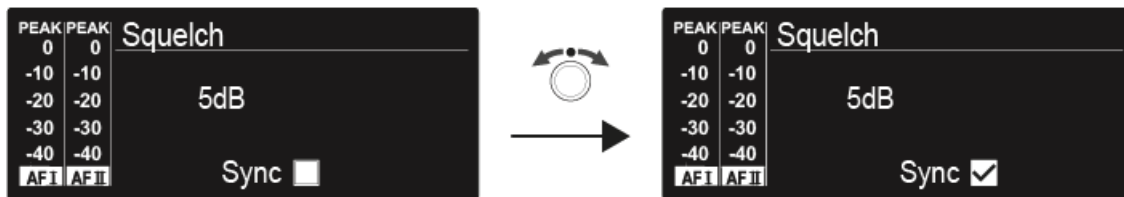

When the check box is activated, the value will be transmitted during synchronization. If it is deactivated, the value will not be transmitted.

You can configure and activate/deactivate the following **parameters**:

- Balance
- Squelch
- Mode
- High Boost
- Auto Lock
- Limiter

See “Synchronizing devices”.

Advanced > RF Power menu item

- Configuring the transmission power

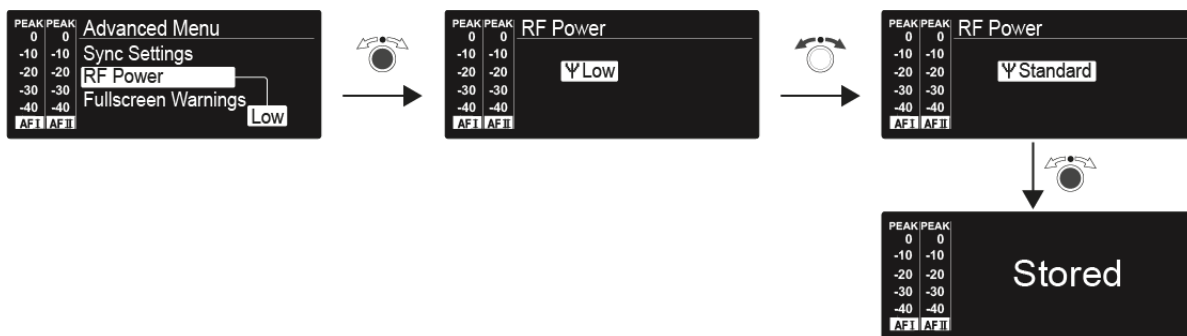

You can configure the transmission power in three steps in the **RF Power** menu item. Please note the information at the following address:

General conditions and restrictions for the use of frequencies

Setting range:

- Low:** 10 mW
- Standard:** 30 mW
- High:** 50 mW



If you are using the AC 41 antenna combiner, the **transmission power** of the connected transmitters cannot be set to more than **30 mW** (default) for legal reasons.



Advanced > Fullscreen Warnings menu item

- Activating/deactivating warnings



You can activate or deactivate the following warnings:

AF Peak

- The audio level is too high.

RF Mute

- The RF signal from the transmitter to the receiver is deactivated.

Advanced > Brightness menu item

- Adjusting the contrast of the display panel

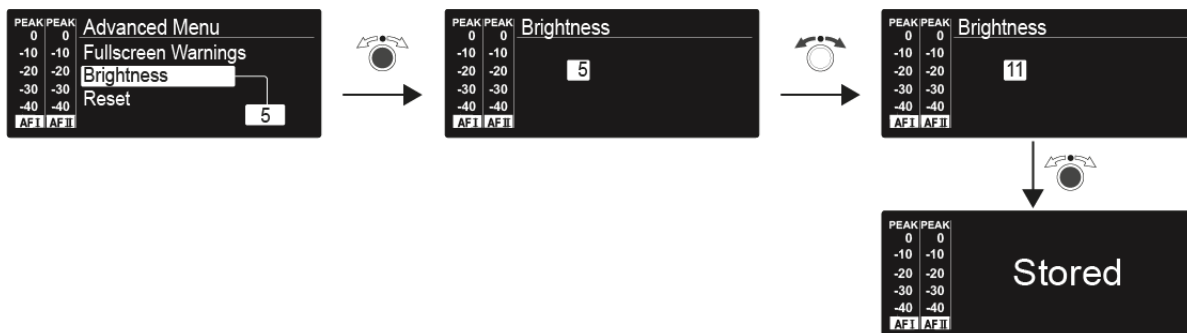

You can configure the contrast of the display in 16 steps.

Setting range: 0 to 15



Advanced > Reset menu item

- Resetting the transmitter

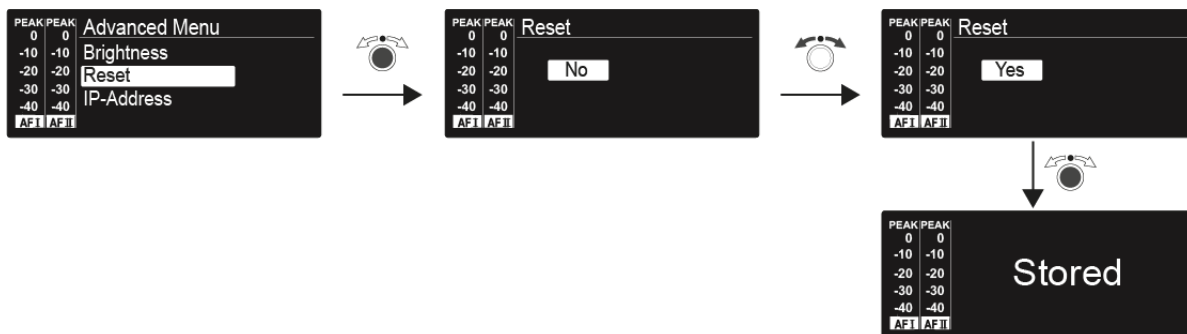

When you reset the transmitter, only the selected settings of the pilot tone and the **U1** to **U6** frequency banks are retained.

Advanced > IP Address menu item

- Adjusting the network configuration

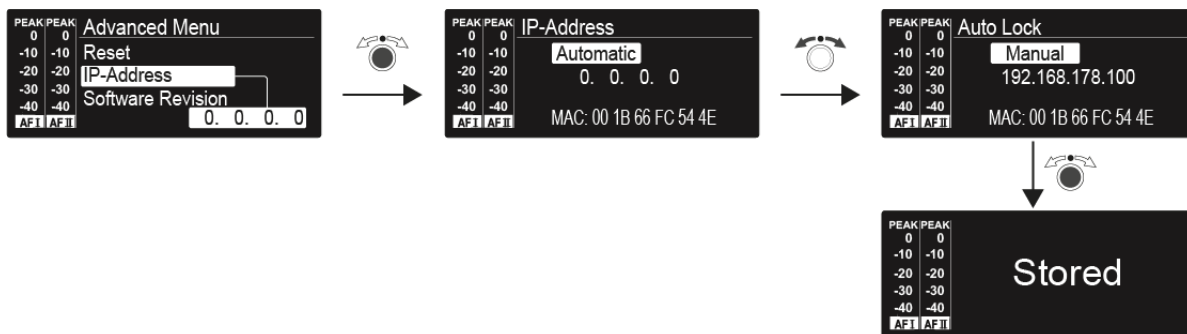

Setting range: Automatic or manual

Advanced > Software Revision menu item

- Show software revision

You can display the current software revision.



Establishing a radio link

To establish a radio link between the transmitter and receiver, the same frequency must be set in both devices.

You can do this in a number of different ways:

1. Use the **Easy Setup** function to perform an **automatic frequency set-up** (see “Easy Setup menu item”).
2. Set a frequency in the receiver **manually** (see “Frequency Preset menu item”) and **synchronize** it with the transmitter (see “Synchronizing devices”).
3. Set the frequency on the receiver and the transmitter **manually** (EK IEM G4: “Frequency Preset menu item”, SR IEM G4: “Frequency Preset menu item”).

Setting notes

Please note the following when synchronizing a transmitter with a receiver:

- ▷ Only use transmitters and receivers from the same frequency range (see the type plate on the transmitter and receiver).
- ▷ Make sure that your chosen frequencies are listed in the frequency table for the particular frequency range (see “Frequency tables”).
- ▷ Ensure that the desired frequencies are permitted in your country and apply for an operating license if necessary.



Please note the information at the following address:

General conditions and restrictions for the use of frequencies



Synchronizing devices

You can synchronize ew IEM G4 series transmitters and receivers via the transmitter's and receiver's infrared interfaces.

The **Easy Setup Sync** function makes it possible to transfer unused frequency presets from your EK IEM G4 receiver to multiple transmitters via the infrared interface after you have performed a frequency preset scan with this receiver. The next unused channel in the receiver's current frequency bank is transferred to your transmitter.

Vice versa, you can use the **Sync** function to configure the settings for your EK IEM G4 portable receiver directly on your stationary SR IEM G4 transmitter and transfer them to the receivers via the infrared interface.

Easy Setup Sync-function (EK IEM G4 -> SR IEM G4) for a single radio link

- ▷ Switch your stationary transmitter and your mobile receivers on.
- ▷ Call up the **Easy Setup** menu item on the transmitter.
- ▷ Choose the **Mute RF For Only This Device?** option.

The **SYNC** display appears in the transmitter display panel and the blue LED on the infrared interface lights up.

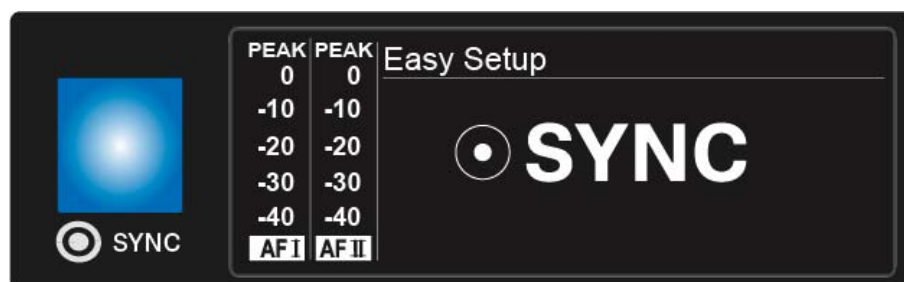

- ▷ Perform a frequency preset scan with your EK IEM G4 mobile receiver (see "Easy Setup menu item") and select a frequency bank with sufficient unused frequencies.



- ▷ Hold the infra-red interface of the receiver in front of the infra-red interface of the first transmitter.

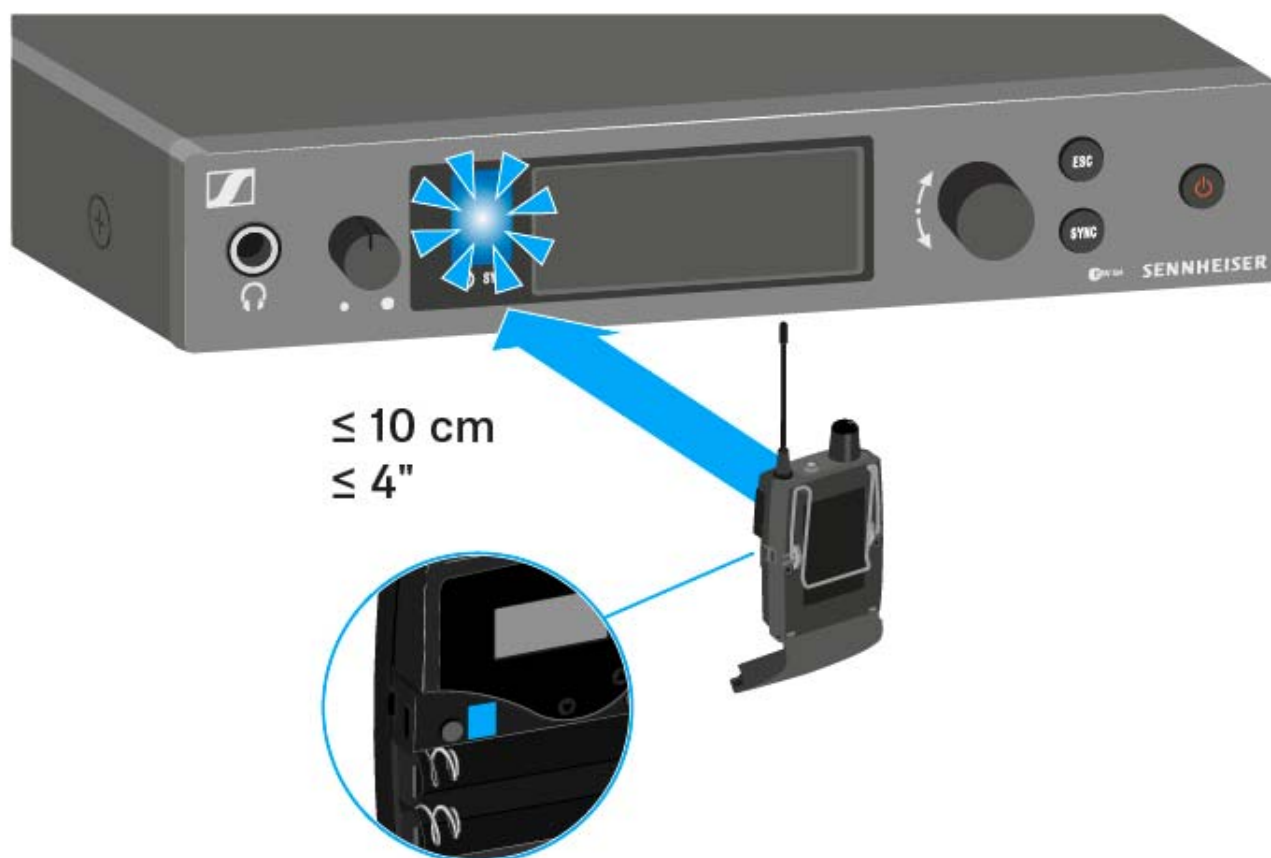

The next unused frequency preset is transferred from the receiver to the transmitter.

Once the transfer is complete, the numbers of the transferred frequency bank and the transferred channel appear in the display panel of the transmitter.

- ▷ Press the jog dial on the transmitter to save the synchronized frequency.
- ▷ Hold the infrared interface of the mobile receiver in front of the infrared interfaces of the remaining transmitters one at a time.

Easy Setup Sync-function (EK IEM G4 -> SR IEM G4) for multi-channel frequency setup

- ▷ Perform the multi-channel frequency setup as described under “Performing multi-channel frequency setup”.



Sync function (SR IEM G4 -> EK IEM G4)

You can adjust the **Parameters** to be transferred to the receivers here: “Advanced > Sync Settings menu item”.

- ▷ Switch the transmitter and the receiver on.
- ▷ Press the **SYNC** button on the transmitter.
Sync appears in the transmitter’s display and the blue LED turns blue.





- ▷ Hold the infra-red interface of the receiver in front of the infra-red interface of the transmitter.

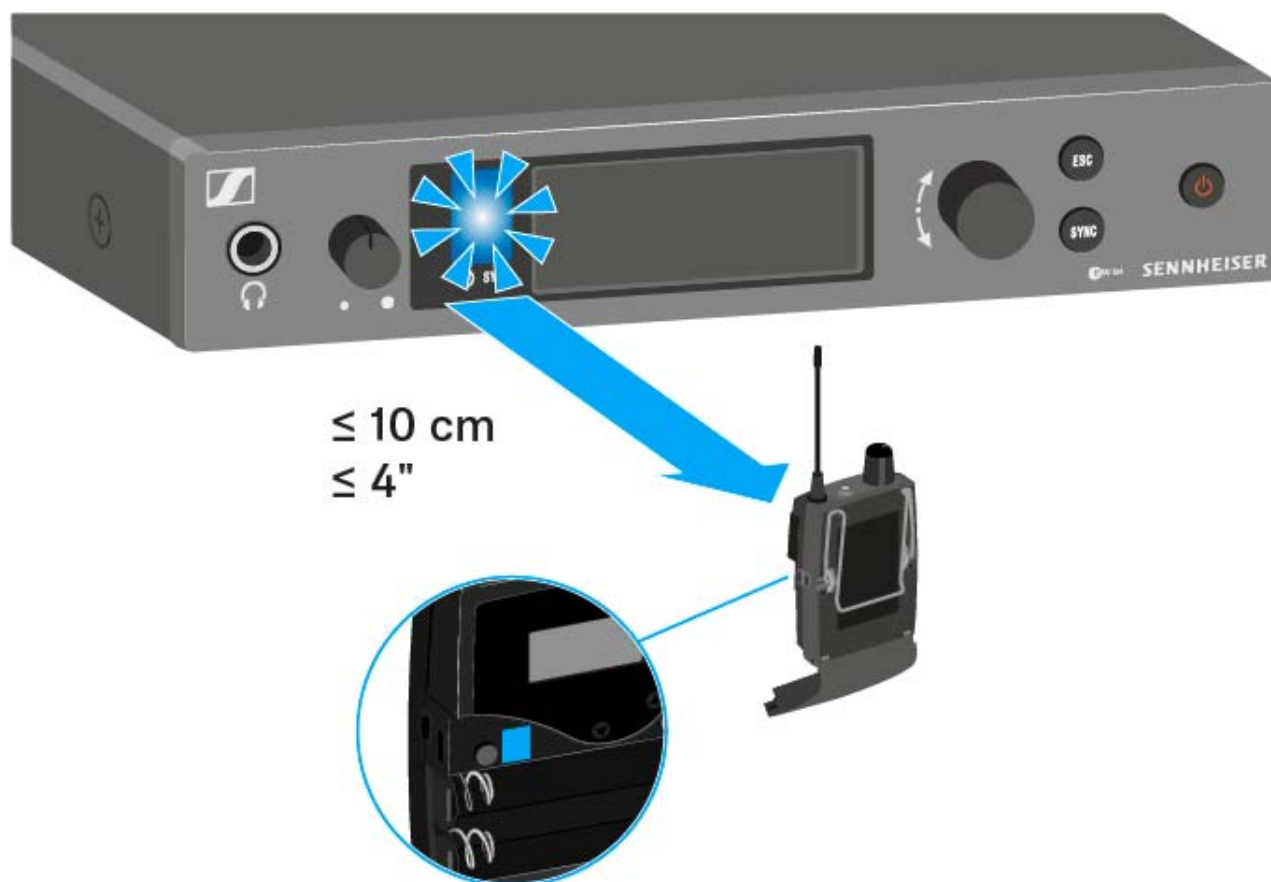

The parameters are transferred to the receiver. The blue LED blinks during transmission.

When the transfer is complete, a tick appears in the transmitter's display as a confirmation. Then the transmitter will return to the standard display.

To cancel synchronization:

- ▷ Press the **ESC** button on the transmitter.
An **X** appears in the display.

This icon also appears when:

- no receiver is found or the receiver is not compatible.
- no receiver is found and the synchronization process automatically ends after 30 seconds.



Using the AC 41

These sections contain detailed information about operating the AC 41.

You can find information on installation and startup of the AC 41 under “Installing the AC 41”.



Operating elements on the front of the device



- 1 ON/OFF button**
 - See “Switching the AC 41 on and off”
- 2 Power LED**
 - See “Switching the AC 41 on and off”
- 3 Status LEDs**
 - Power supply of the transmitter
 - See “Meaning of the LEDs”



Switching the AC 41 on and off

To **switch on** the antenna combiner:

- ▷ Briefly press the **ON/OFF** button.
The antenna combiner switches on and the power LED turns green.
The transmitters receive the RF signal. The status LEDs light up (see “Meaning of the LEDs”).

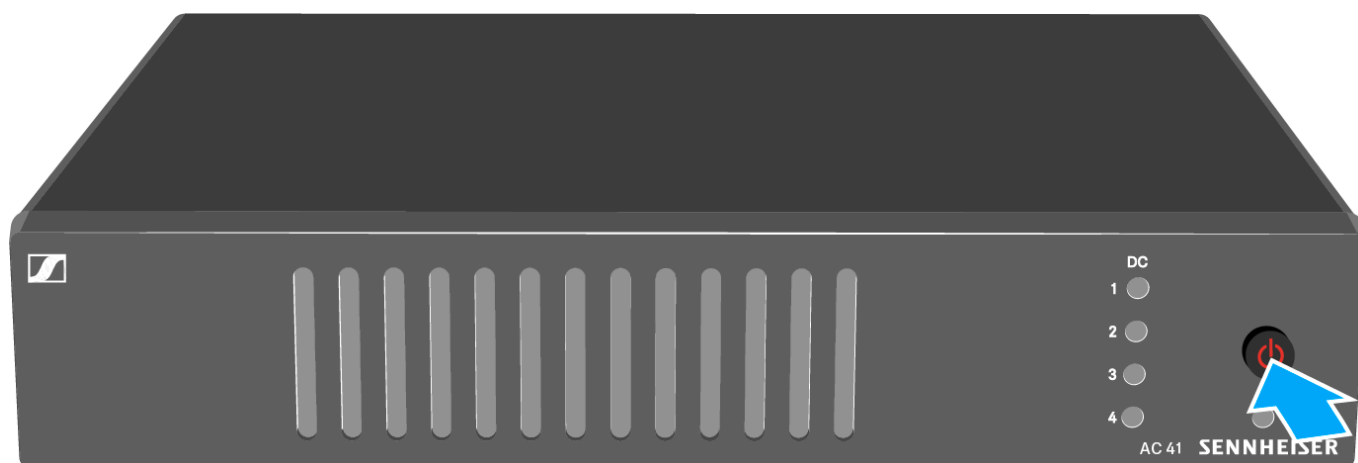

To switch the antenna combiner to **standby mode**:

- ▷ Hold down the **ON/OFF** button until the power LED turns off.

To **fully switch off** the antenna combiner:

- ▷ Disconnect the antenna combiner from the power supply system by unplugging the power supply unit from the wall socket.



Meaning of the LEDs

LEDs 1 to 4 **are lit**:

- The transmitters have been connected correctly as described under “Connecting the AC 41 with transmitters”.
 - Sockets RF IN 1 to RF IN 4 have supply voltage for the transmitters.



LEDs 1 to 4 **are not lit**:

- The transmitters are not compatible with the AC 41 antenna combiner.
 - Make sure that the transmitter has its own power supply.
- or
- There is a short circuit at the sockets **RF IN 1 to RF IN 4**.
 - Check the antenna connections.
 - Replace the connecting cable if needed.





SPECIFICATIONS

Overview

In the sections below, you can find information about the different variants of the products in the **ew IEM G4** series as well as technical data for the individual products.

- Product variants and frequency variants >> “Product variants”
- Frequency tables with overviews of all banks and channels >> “Frequency tables”
- Product-specific technical data >> “Specifications”
- Information on pin assignment (jack and XLR) >> “Pin assignment”

You can also find information about safely cleaning and maintaining **evolution wireless G4** series products.

- “Cleaning and maintenance”



Product variants

EK IEM G4 product variants

Made in Germany

EK IEM G4-A1	470 – 516 MHz	Art. no. 507849
EK IEM G4-A	516 – 558 MHz	Art. no. 507850
EK IEM G4-GB	606 – 648 MHz	Art. no. 507851
EK IEM G4-G	566 – 608 MHz	Art. no. 507852
EK IEM G4-B	626 – 668 MHz	Art. no. 507853
EK IEM G4-C	734 – 776 MHz	Art. no. 507854
EK IEM G4-E	823 – 865 MHz	Art. no. 507855

Assembled in the USA

EK IEM G4-A1	470 – 516 MHz	Art. no. 508188
EK IEM G4-A	516 – 558 MHz	Art. no. 508189
EK IEM G4-AS	520 – 558 MHz	Art. no. 508190
EK IEM G4-G	566 – 608 MHz	Art. no. 508191
EK IEM G4-B	626 – 668 MHz	Art. no. 508192
EK IEM G4-C	734 – 776 MHz	Art. no. 508193
EK IEM G4-D	780 – 822 MHz	Art. no. 508194



SR IEM G4 product variants

Made in Germany

SR IEM G4-A1	470 – 516 MHz	Art. no. 507842
SR IEM G4-A	516 – 558 MHz	Art. no. 507843
SR IEM G4-GB	606 – 648 MHz	Art. no. 507844
SR IEM G4-G	566 – 608 MHz	Art. no. 507845
SR IEM G4-B	626 – 668 MHz	Art. no. 507846
SR IEM G4-C	734 – 776 MHz	Art. no. 507847
SR IEM G4-E	823 – 865 MHz	Art. no. 507848

Assembled in the USA

SR IEM G4-A1	470 – 516 MHz	Art. no. 508181
SR IEM G4-A	516 – 558 MHz	Art. no. 508182
SR IEM G4-AS	520 – 558 MHz	Art. no. 508183
SR IEM G4-G	566 – 608 MHz	Art. no. 508184
SR IEM G4-B	626 – 668 MHz	Art. no. 508185
SR IEM G4-C	734 – 776 MHz	Art. no. 508186
SR IEM G4-D	780 – 822 MHz	Art. no. 508187

AC 41 product variants

AC 41-EU	Art. no. 576761	NT 3-1-EU
AC 41-US	Art. no. 576762	NT 3-1-US
AC 41-UK	Art. no. 576761	NT 3-1-UK



Frequency tables

You can find frequency tables for all available frequency ranges in the download section of the Sennheiser website under www.sennheiser.com/download.

Download area of the Sennheiser website

Enter **ew G4** into the search bar to show the frequency tables.



Specifications

You can find the cross-system and product-specific technical data in the sections below.



EK IEM G4

RF characteristics

Modulation	Wideband FM
Receiving frequency ranges	A1: 470 – 516 MHz A: 516 – 558 MHz AS: 520 – 558 MHz G: 566 – 608 MHz GB: 606 – 648 MHz B: 626 – 668 MHz C: 734 – 776 MHz D: 780 – 822 MHz E: 823 – 865 MHz
Receiving frequencies	Max 1680 receiving frequencies, adjustable in 25 kHz steps 20 frequency banks, each with up to 16 factory-preset channels, no intermodulation 6 frequency banks with up to 16 programmable channels
Switching bandwidth	up to 42 MHz
Nominal/peak deviation	± 24 kHz / ± 48 kHz
Receiver principle	Adaptive diversity
Sensitivity (with HDX, peak deviation)	< 4 μ V, typically 1.6 μ V for 52 dBA _{rms} S/N
Adjacent channel selection	Typically ≥ 65 dB
Intermodulation attenuation	Typically ≥ 70 dB
Blocking	≥ 80 dB
Squelch	5 to 25 dB μ V, adjustable in 2 dB steps
Pilot tone squelch	Can be switched off



AF characteristics

Componder system	Sennheiser HDX
Signal-to-noise ratio (1 mV, peak deviation)	approx. 90 dBA
Total harmonic distortion (THD)	≤ 0.9 %
Output power at 2.4 V 5% THD, nominal deviation	2 x 100 mW at 32 Ω
High Boost	+8 dB at 80 kHz
Limiter	-18 dB to -6 dB in 6 dB steps, can be switched off

Overall device

Temperature range	-10 °C to +55 °C (-13 °F to 158 °F)
Power supply	2 AA batteries, 1,5 V or BA 2015 accupack
Nominal voltage	3 V battery 2.4 V rechargeable battery
Power consumption	
at nominal voltage with transmitter switched off	typically 140 mA ≤ 25 μA
Operating time	approx. 4 to 6 hours (depending on the volume level)
Dimensions	approx. 82 x 64 x 24 mm
Weight (with batteries)	Approx. 125 g



SR IEM G4

RF characteristics

Modulation	Broadband FM stereo (MPX pilot tone procedure)
Receiving frequency ranges	A1: 470 – 516 MHz A: 516 – 558 MHz AS: 520 – 558 MHz G: 566 – 608 MHz GB: 606 – 648 MHz B: 626 – 668 MHz C: 734 – 776 MHz D: 780 – 822 MHz E: 823 – 865 MHz
Receiving frequencies	Max 1680 receiving frequencies, adjustable in 25 kHz steps 20 frequency banks, each with up to 16 factory-preset channels, no intermodulation 6 frequency banks with up to 16 programmable channels
Switching bandwidth	up to 42 MHz
Nominal/peak deviation	± 24 kHz / ± 48 kHz
MPX pilot tone (frequency/devia- tion)	19 kHz/ ± 5 kHz
Frequency stability	± 10 ppm
Antenna output	BNC socket, 50 Ω
RF output power at 50 ?	Switchable: Low: typically 10 mW Standard: typically 30 mW High: typically 50 mW



AF characteristics

Compander system	Sennheiser HDX
AF frequency response	25 to 15,000 Hz
AF input BAL AF IN L (I) + MONO/ BAL AF IN R (II)	2x XLR-3/ 6.3 mm jack combo socket (1/4"), electrical- ly balanced
Max. input level	+22 dBu
Total harmonic distortion (at 1 kHz and nominal deviation)	≤ 0.9 %
Signal-to-noise ratio at rated in- put and peak deviation	> 90 dB
AF output LOOP OUT BAL L (I)/ LOOP OUT BAL R (II)	6.3mm stereo jack socket (1/4"), balanced

Overall device

Temperature range	-10 °C to +55 °C (-13 °F to 158 °F)
Power supply	12 V DC
Power consumption	max. 350 mA
Dimensions	approx. 202 x 212 x 43 mm
Weight	approx. 980 g



IE 40 PRO earphones

Frequency response	20 – 18,000 Hz
Impedance	20 Ω
Sound pressure level	115 dB (1 kHz / 1 V rms)
Total harmonic distortion (THD)	< 0.1 % (1 kHz, 94 dB)
Noise attenuation	< 26 dB
Magnetic field strength	3.5 mT
Temperature	
Operation:	-5 °C to +50 °C (-13 °F to 158 °F)
Storage:	-20 °C to +70 °C (-13 °F to 158 °F)
Relative air humidity	< 95 %

IE 400 PRO earphones

Frequency response	6 – 19,000 Hz
Impedance	16 Ω
Sound pressure level	123 dB (1 kHz / 1 V rms)
Total harmonic distortion (THD)	< 0.08 % (1 kHz, 94 dB)
Noise attenuation	< 26 dB
Magnetic field strength	2 mT
Temperature	
Operation:	-5 °C to +50 °C (-13 °F to 158 °F)
Storage:	-20 °C to +70 °C (-13 °F to 158 °F)
Relative air humidity	< 95 %

IE 500 PRO earphones

Frequency response	6 – 20,000 Hz
Impedance	16 Ω
Sound pressure level	126 dB (1 kHz / 1 V rms)
Total harmonic distortion (THD)	< 0.08 % (1 kHz, 94 dB)
Noise attenuation	< 26 dB
Magnetic field strength	2 mT
Temperature	
Operation:	-5 °C to +50 °C (-13 °F to 158 °F)
Storage:	-20 °C to +70 °C (-13 °F to 158 °F)
Relative air humidity	< 95 %



IE 4 earphones

Frequency ranges	40 – 20,000 Hz
Max. sound pressure level (SPL)	118 dB SPL
Sound pressure	106 dB (1 kHz, 1 mW)
Impedance	32 Ω
Nominal impedance	16 Ω
Cable length	1.4 m
Connector	3.5 mm stereo plug, gold-plated



AC 41

Specifications

Frequency ranges	
AC 41-EU/UK:	470 – 870 MHz
AC 41-US	470 – 608 MHz
Transmission loss	0 dB (± 1 dB)
RF input power	max. 30 mW per input
Impedance	50 Ω
Power supply	13.8 V DC (with tabletop power supply unit NT 3-1)
Total power consumption	max. 3.4 A (with connected transmitters)
Transmitter power supply on RF IN 1 to RF IN 4	11.4 V DC (protected against reverse supply), 350 mA
Relative air humidity	5 to 95%
Temperature range	
Operation:	-10 °C to +55 °C (-13 °F to 158 °F)
Storage:	-20 °C to +70 °C (-13 °F to 158 °F)
Dimensions	approx. 212 x 168 x 43 mm
Weight	approx. 1470 g



Block diagram

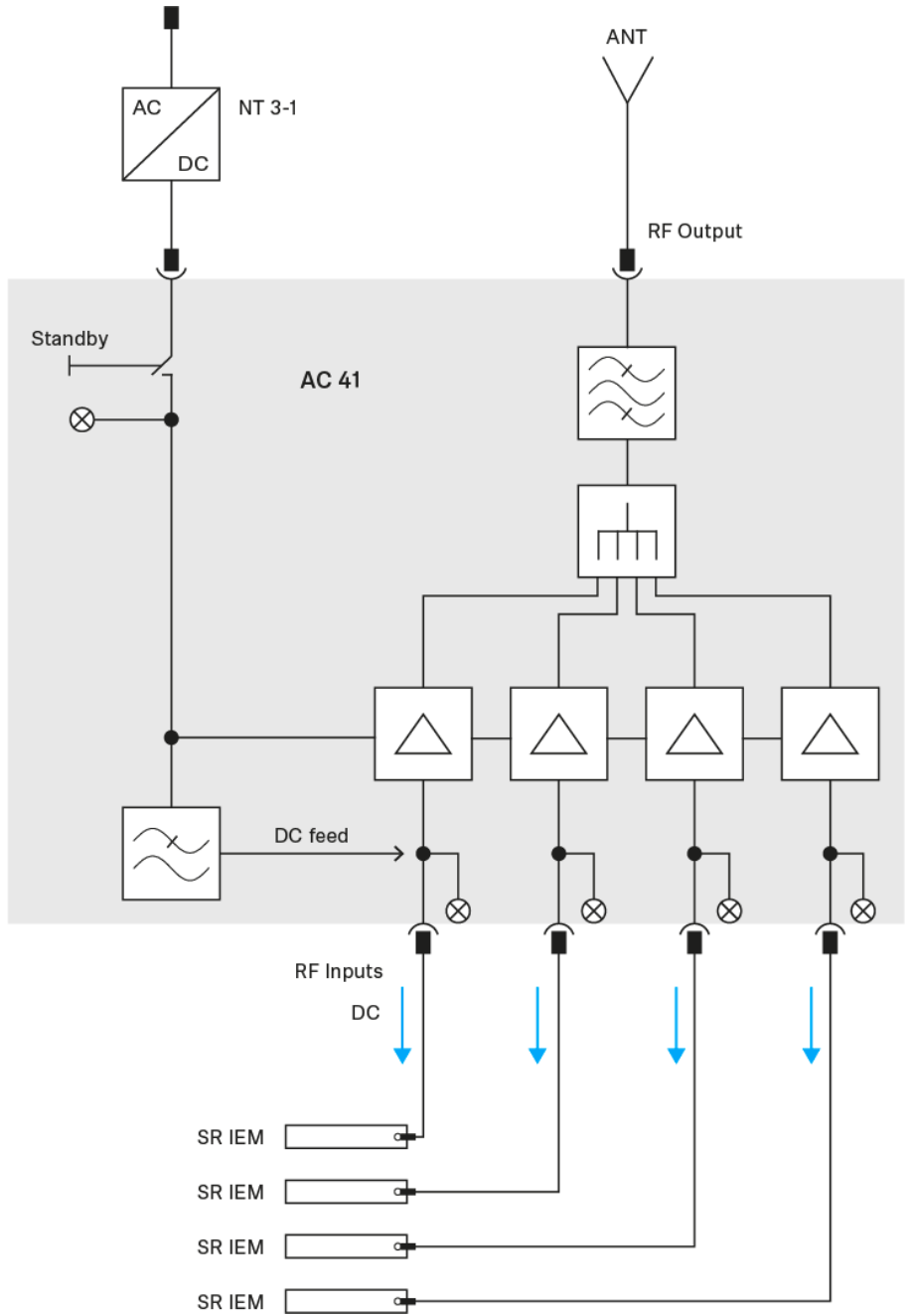



Pin assignment

3.5 mm stereo jack plug

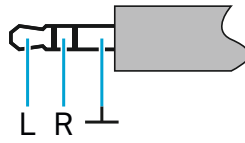

- Plug for headphone and earphone cables, e.g. IE 4.
- Connect to:
 - EK IEM G4

6.3 mm stereo jack plug, balanced (audio in/loop out)

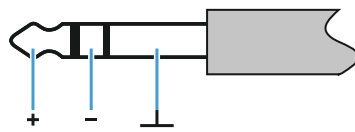

- Connect to:
 - SR IEM G4 Audio In
 - SR IEM G4 Loop Out

6.3 mm stereo jack plug for headphone jack

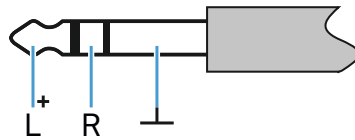

- Connect to:
 - SR IEM G4 headphone input

XLR-3 plug, balanced

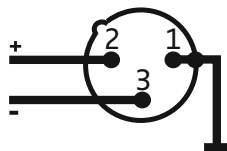

Hollow jack plug for power supply





Cleaning and maintenance

Note the following information when cleaning and maintaining evolution wireless G4 series products.

CAUTION

Liquids can damage the products' electronics.

Liquids entering the product housing can cause a short-circuit and damage the electronics.

- ▷ Keep all liquids away from the products.
 - ▷ Do not use any solvents or cleansing agents.
-
- ▷ Disconnect the products from the power supply system and remove rechargeable batteries and batteries before you begin cleaning.
 - ▷ Clean all products only with a soft, dry cloth.