

# **DASnet** *speaker management software*

UM\_DASnet1.15\_EN



## **INDEX**

### **DASnet HARDWARE**

DASnet HARDWARE	4
BASIC CONNECTIONS	9

### **DASnet SOFTWARE**

INTRODUCTION	12
INSTALLING THE SOFTWARE	12
STARTING THE SOFTWARE	13
LAYOUT OF THE MAIN WINDOW	14
REORGANISING THE WINDOW	15
AUTO-HIDING WINDOWS	17
ZONING DEVICES	18
COMMUNICATION WITH THE DEVICES	19
AUTO-SCAN	19
DASnet dnd FILES	21
ADDING DEVICES MANUALLY	23
DEVICE VIEW WINDOWS	24
ROAD SERIES	24
CONVERT 15A	27
AERO 40A	31
LX-218CA_net	35
aero 20A	38
DEVICE VIEW WINDOWS - DSP	42
MIXER MENU	42
INPUT EQ MENU	45
OUTPUT EQ MENU	45
LINK MANAGER	47
CUSTOM PANELS	53
IMAGE LIBRARY MANAGER	60
APPENDIX 1. QUICK AERO40A SYSTEM CONFIGURATION	61
APPENDIX 2. MOVE TO MAIN WINDOW	66
APPENDIX 3. SNAPSHOTS	68

# ***DASnet*** ***hardware***

# 1. DASnet HARDWARE

DASnet is a remote monitoring and control software designed to be used with self powered DAS Audio systems and digital signal processors. Besides monitoring the “status” of the amplifier channels and speaker’s impedance (loads) the user may configure different settings on the systems (presets). The software it is based on an RS-485 network. All devices on the net have to be connected in a daisy chain / star configuration.

D.A.S. Audio devices equipped with DASnet are:

Road series, LX-218CA\_net, Convert 15A, aero 40A, aero 20A.

The hardware needed to use DASnet will be provided by DAS Audio. The use of any other materials not supplied by the manufacturer will not assure the optimal performance of the system and may cause interference problems between analog audio and monitoring data.

DAS Audio strongly recommends the use of these accessories:

## USB-RS485 converter



## Power Link:



## EtherCon cable (eC): Shielded STP CAT7 cable



## EtherCon cable + Powercable (eCP):

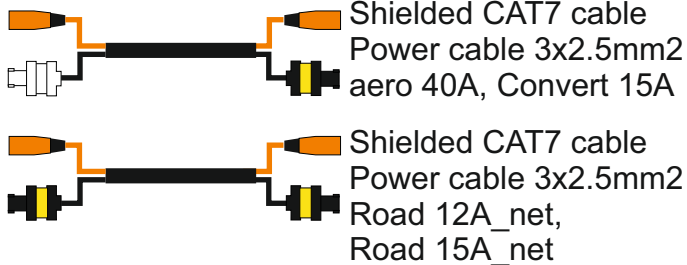

## D.A.S. Audio code

USB-RS485

*Plink1\_09*

(number refers to cable length, meters)

*eC\_0.9, eC\_2, eC\_20*

(number refers to cable length, meters)

*eCP\_20, eCP\_3*

(number refers to cable length, meters)

*eCPk\_1 / eCPk\_5 /*

(number refers to cable length, meters)

## Important

Only use DAS Audio cables with DASnet. Any other type of cabling may cause interferences and background noise.

## DASnet patch panel:

*DASnet patch*

Audio / power and DASnet patch panel to connect all the devices on the net

Three independent audio / dasnet / power “zones”

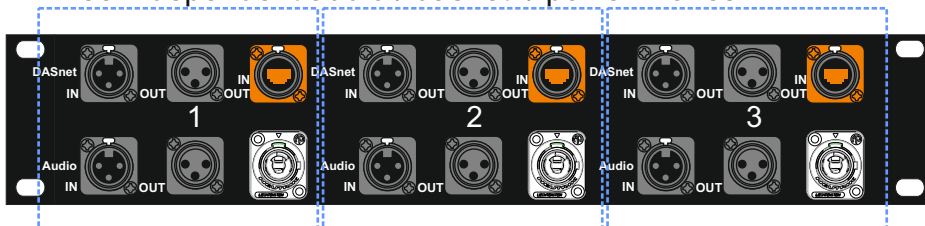

audio and DASnet data can be linked between “zones”

## Important

On the DASnet patch panels the ethercon connectors (orange) are used to transport ANALOG audio and DASnet DATA.



## 230V DASnet Rack:

## 230V DASnet Rack

Includes two or more DASnet patch panels and one 32Amp 3phase power distro.  
Each phase is connected to two powercon outputs.

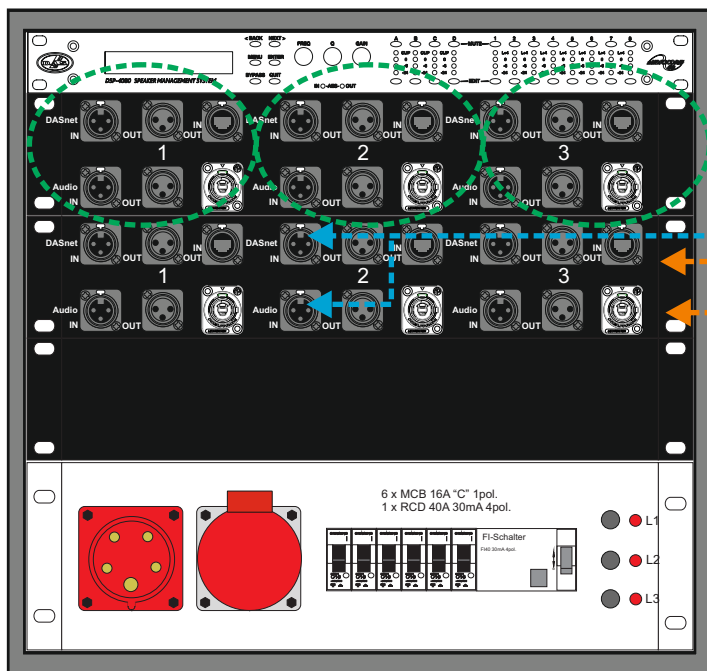

The patch panel has different “zones” limited by the maximum current allowed by the powerCon connector (20A).

On each “zone” there is an audio input and a DASnet input. Also there are two outputs per zone, audio and DASnet data.

The main out to the cabinets is composed by a powercon and an Ethernet Out that is used to send ANALOG audio and monitoring / control DATA.

## 115V DASnet Rack:

## 115V DASnet Rack

Includes two or more DASnet patch panels and two 30Amp 3 phase power distros.

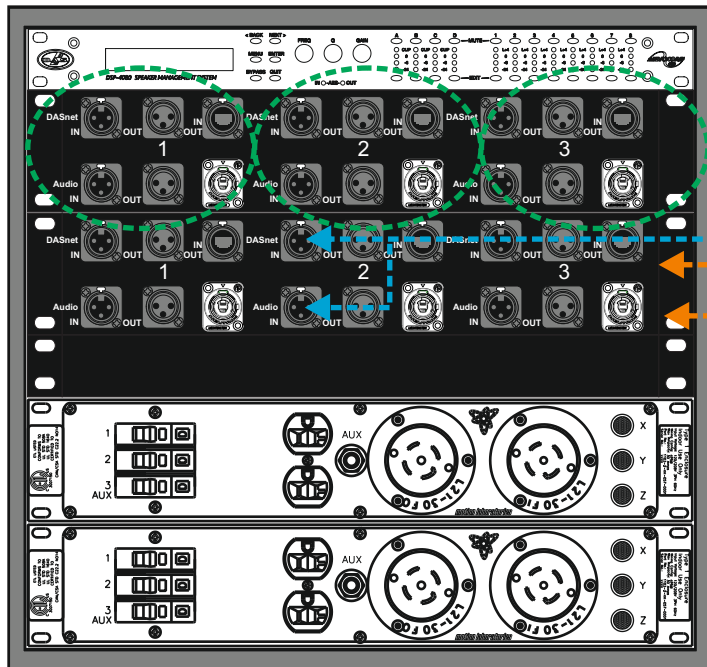

The patch panel has different “zones” limited by the maximum current allowed by the powerCon connector (20A).

On each “zone” there is an audio input and a DASnet input. Also there are two outputs per zone, audio and DASnet data.

The main out to the cabinets is composed by a powercon and an Ethernet Out that is used to send ANALOG audio and monitoring / control DATA.

### Important

Each “zone” can have different analog audio inputs.  
Never connect an ethernet device (router, switch etc) to the DASnet patch panels.  
DASnet uses STP CAT7 ethernet cables to transport analog audio and data. It is not a real ethernet NET.

**DASnet patch 26 and 48: (NEW)**

There are two new models of the DASnet patches, totally compatible with the existing DASnet cabling. These patches are intended to save cabling and to be used always in conjunction with DAS dsp's.

The patch panel has two/four inputs directly connected to the input channels of the processor. Two or four audio links (signal in parallel before processing) are also available. In the output section (depending on the processor model) 6 or 8 audio outputs (processed) are available. Linked to each output there is an ethercon output carrying DASnet and analog audio (processed audio from the dsp's channel).

DASnet patch48

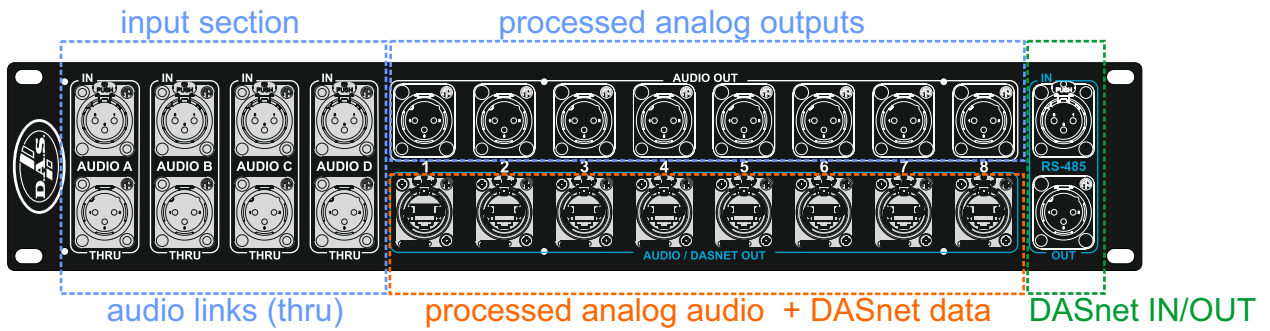

DASnet patch26

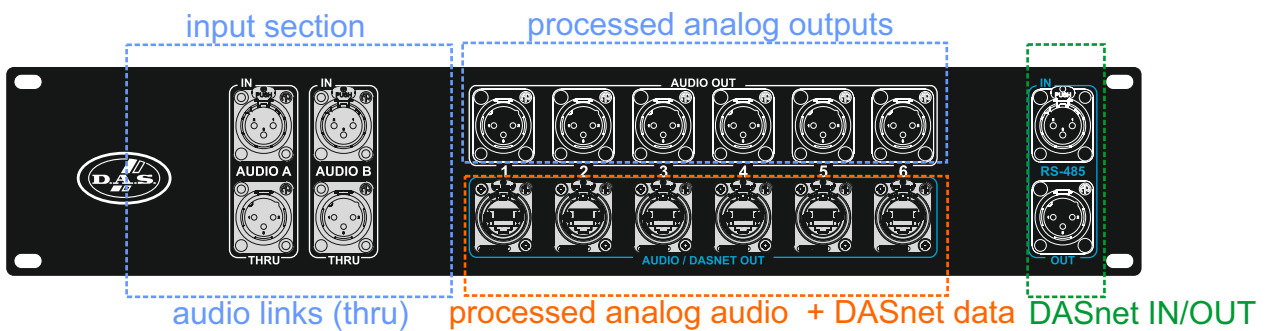

**230V DASnet Rack26 and 48: (NEW)**

Includes one DASnet patch26 (48) panel and one 32Amp 3phase power distro. Each phase is connected to two powercon outputs.

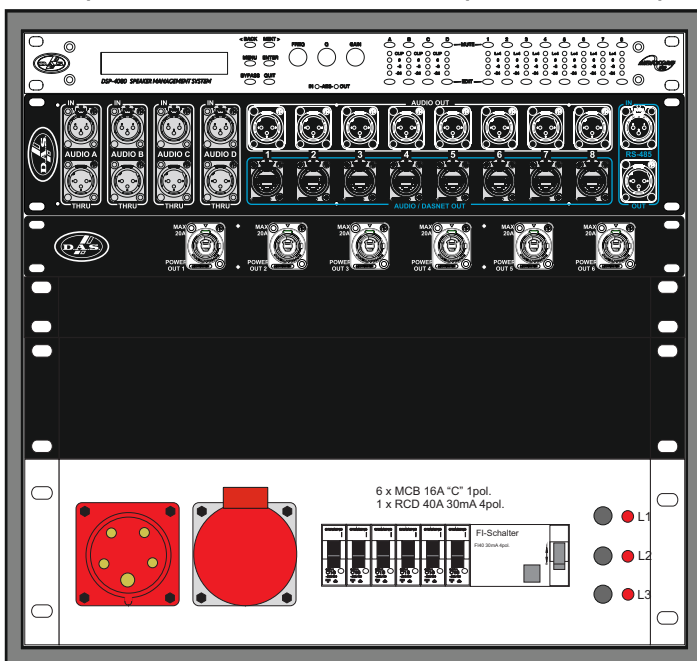

DSP-4080 (2060A) included in the rack.

The patch panel 48 (26) has 6 or 8 ethercon outputs.

There is also a Powercon panel with 6 connector. Each phase of the power distro feeds two powercon connectors.

## 115V DASnet Rack26 and 48: (NEW)

Includes one DASnet patch26 (48) panel and one 30Amp 3phase power distro.  
Each phase is connected to two powercon outputs.

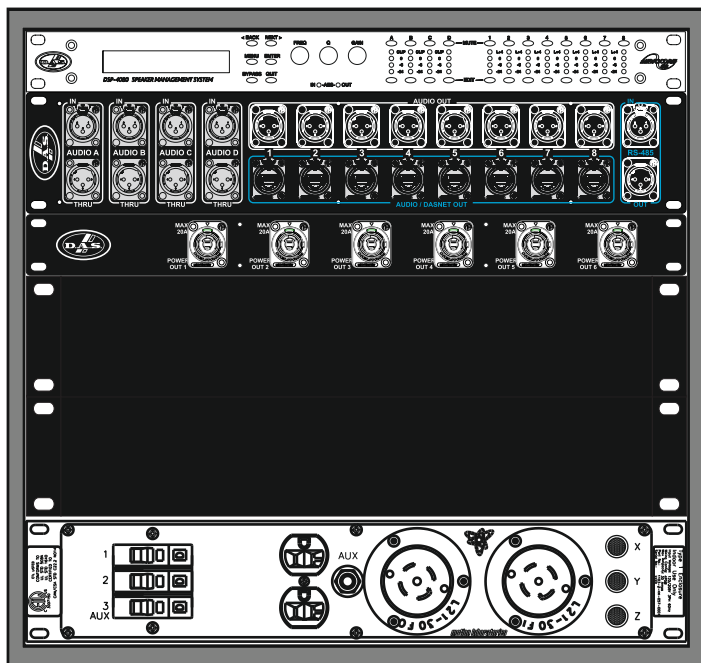

DSP-4080 (2060A) included in the rack.

The patch panel 48 (26) has 6 or 8 ethercon outputs.

There is also a Powercon panel with 6 connector. Each phase of the power distro feeds two powercon connectors.

## DASnet Splitter:(NEW)

Steel case intended for distribution of analog audio, monitoring data and power to multiple devices.

It includes: - One input power (1 x powerCon true 1) and 3 power outputs (3 x powercon NAC3MPB).

- One audio+monitoring data input, and three audio + monitoring data outputs

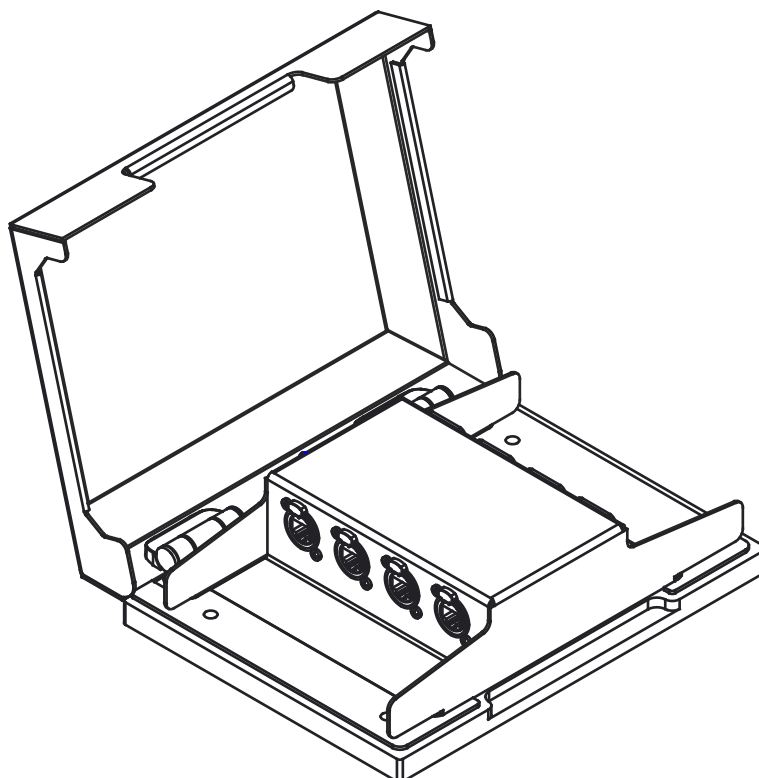

## DASnet cables

With each system **cabling and patch panels are provided**. It is very important to use the system with the intended cables to prevent electromagnetic interferences between the analog audio signal, the DASnet data and the power. Be sure to check the specifications provided by the cable manufacturer. It is also especially important when installing connectors yourself, to note that when termination is not accurate, a cable will be unable to achieve its maximum performance and could have interferences.

There are 4 different types of cables.

- The main feeds which include power and a STP, CAT7 cable. These cables are named **eCP\_xx** (xx refers to cable length).

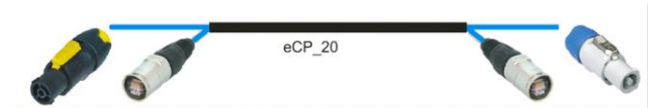

- The links between cabinets (aero40A/Convert15A/LX-218CANet), which are STP CAT7 cables. Cable code **eC\_09**



- Power Links between cabinets. Cable code **Plink1\_09**



- Links for RoadNet series. Power+STP CAT7. eCPk 1/eCPk 5



### Important

The main feed cable eCP\_xx has the following structure:

STP CAT 7 cable with Aluminium Shield for each individual pair and a main aluminium Shield.

The main Shield has to be soldered to the etherCon housing.

The eC\_09 cable is a CAT5e cable with global Aluminium Shield.

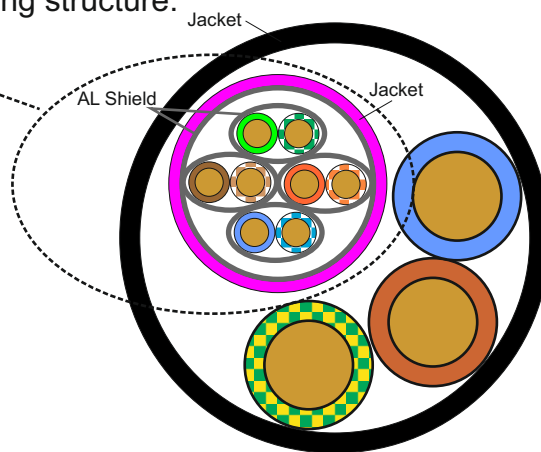

eCP\_xx: Power cable 3x2.5mm<sup>2</sup> + CAT7 4x (2 x 0.14mm<sup>2</sup>)

The pin out of the EtherCon to XLR is the following on the eCP cables:

etherCon	XLR
1 Orange-White	Audio+ 2
2 Orange	Audio- 3
3 Green-White	Audio Earth 1
4 Blue	
5 Blue-White	
6 Green	Data Earth 1
7 Brown-White	Data- (A) 3
8 Brown	Data+ (B) 2

## 2. BASIC CONNECTIONS

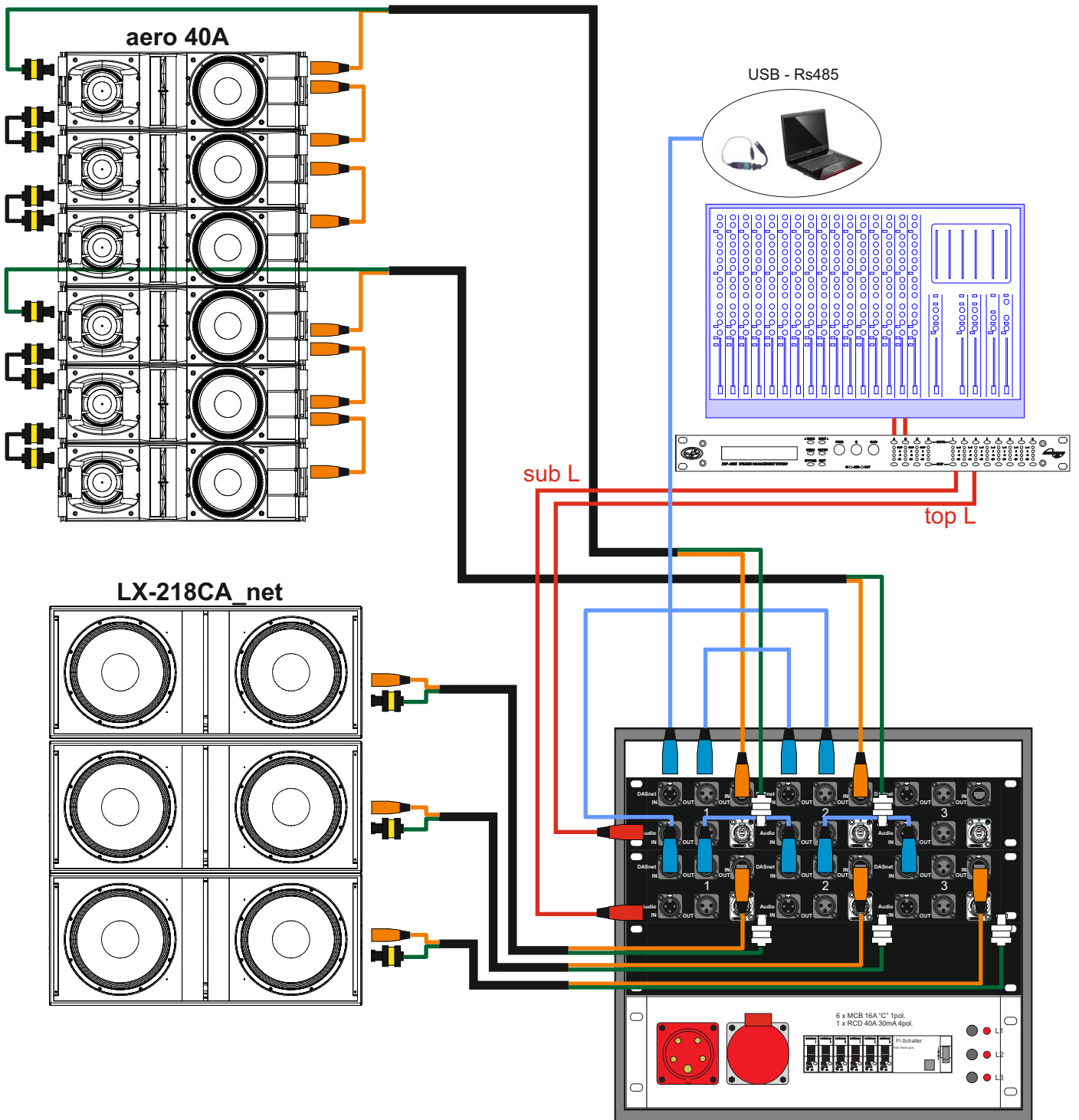
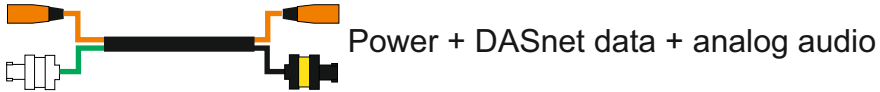



## 2.1 BASIC CONNECTIONS with new DASnet patch and Splitter

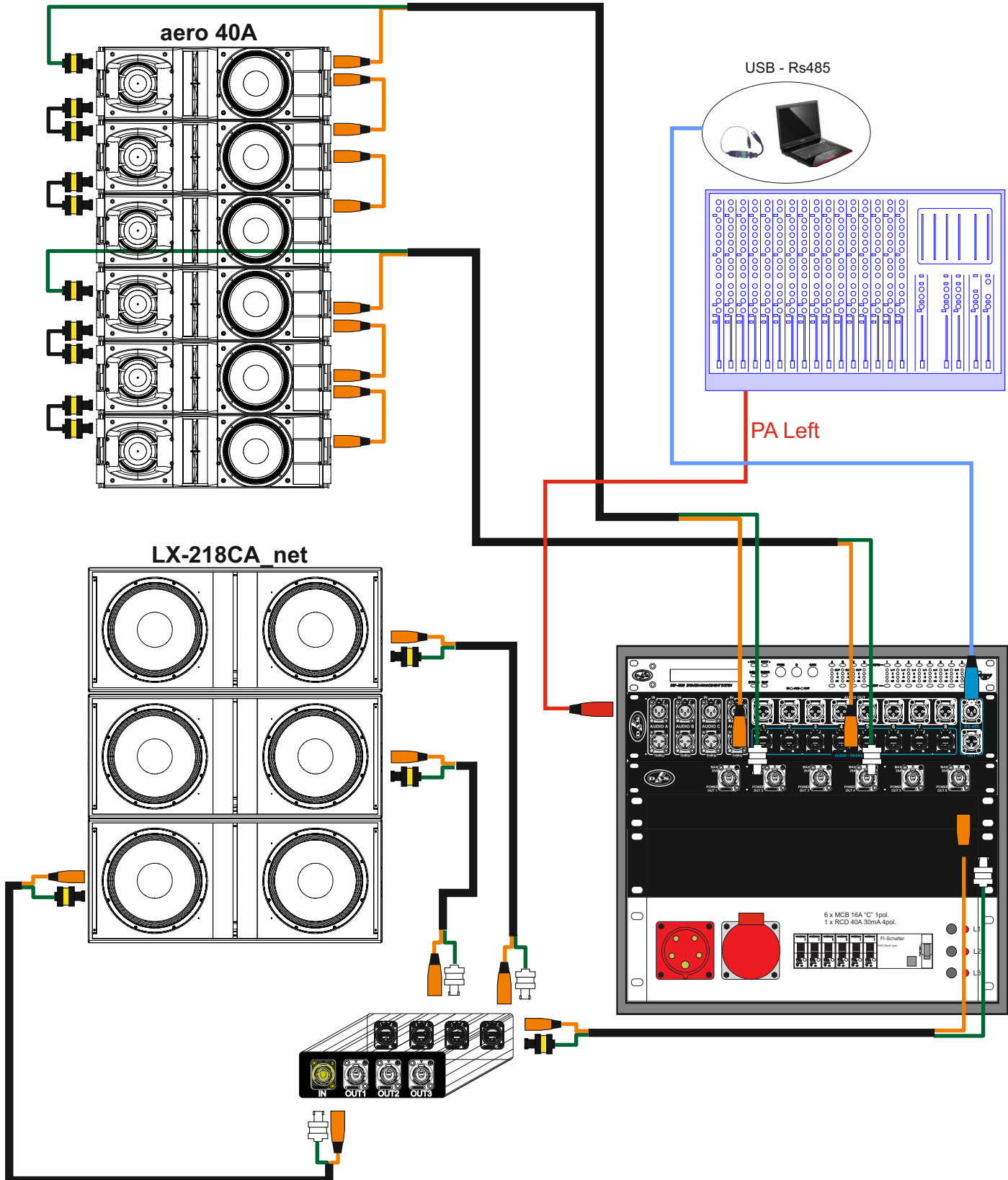
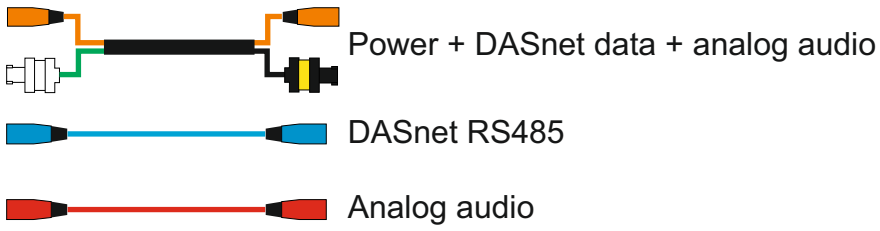

# ***DASnet*** *software*

## 1. INTRODUCTION

DASnet is the monitoring and control software for D.A.S. Audio powered sound systems and digital signal processors.

This manual covers the installation and use of D.A.S. Audio's proprietary software package known as DASnet. This software is a remote control application running under Microsoft Windows™ and is compatible with the following D.A.S. Audio products:

The DSP-2060A Speaker Management System  
The DSP-4080 Speaker Management System  
The Convert 15A Speaker System  
The LX-218CA Speaker System  
The aero 40A Line Array System  
The aero 20A Line Array System

The software has been designed to allow all these products to be connected to a computer through a variety of interfaces and will permit full remote control of any combination of up to 256 devices. The maximum distance covered is up to 1000meters.

The software can be downloaded from D.A.S. Audio website:

[www.dasaudio.com/en/support/software-2/](http://www.dasaudio.com/en/support/software-2/)

Always check the website for updates. There is a firmware updater (DASloader) software for the cabinets that can be used to update the firmware of the cabinets including improvements and new added features. The software can also be downloaded from the D.A.S. website.

## 2. INSTALLING THE SOFTWARE

Please note that this software will not run under Windows™ 3.1 or 3.11. It is designed for Windows™ 95/98/NT4 2000, ME, XP, Windows 7 and Windows 8.

Follow these steps to install your copy of DASnet for Windows™

Once the installer has been downloaded from the website double click and install it. Select the

Pay attention to Administrator mode in W7 and W8 system. To execute the program once it has been installed the user has to run it as an administrator on W7.

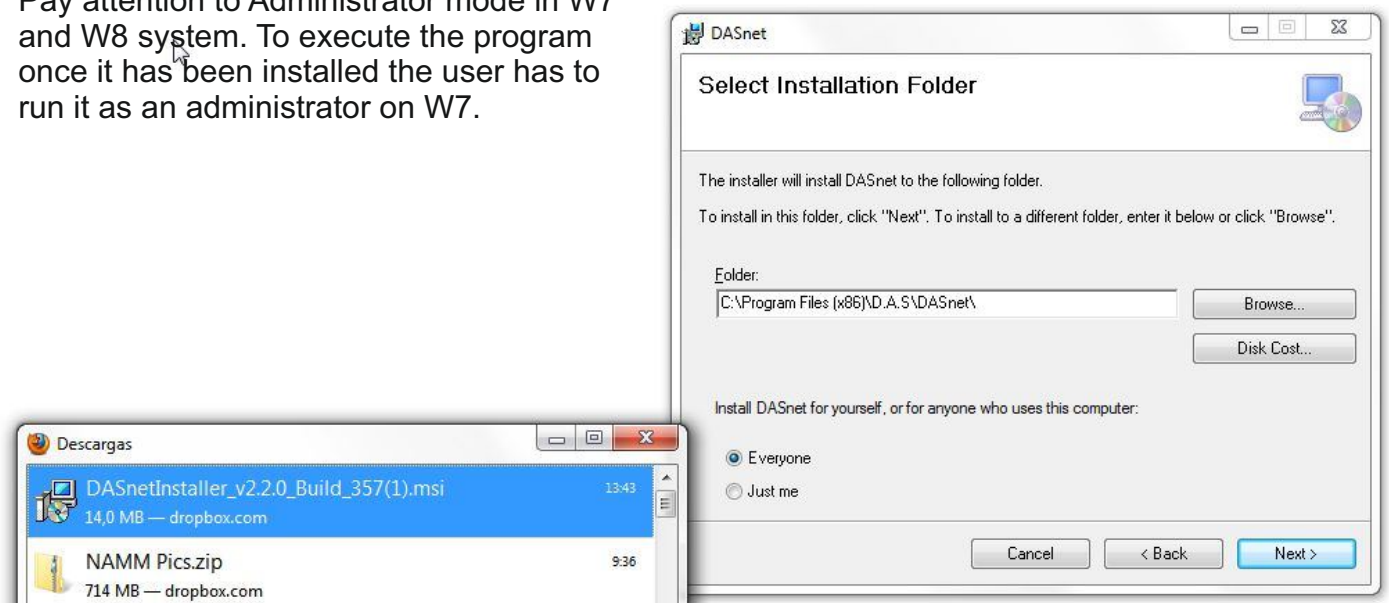



### 3. STARTING THE SOFTWARE

The installation procedure will have created an entry in the 'Programs' list off the 'Start' menu.

#### Important

The software bases its communication system on the **RS-485** format. It is necessary to convert that format at the access port of the control computer. The converter will create a virtual COM port on the computer that the software will detect automatically.

The basic connection uses an **RS-485 to USB converter**; the recommended device is the kksystems ([www.kksystem.com](http://www.kksystem.com)) RS-485 to USB converter (refer to the installation and operation manual for more details).

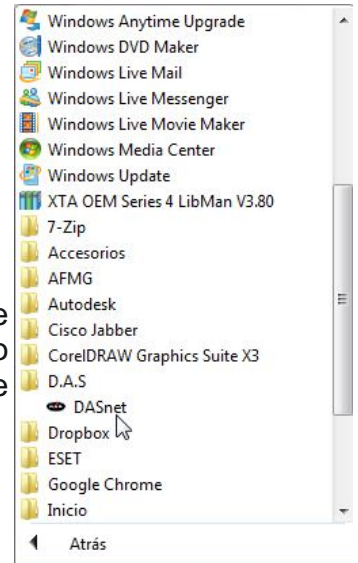

Easy to install the device works as a virtual COM port and allows daisy chaining multiple units. From the PC to the first unit, from this one to the second, etc.

When running the software for the first time, make sure that all windows are active. Go to the *view menu* and activate all of them.

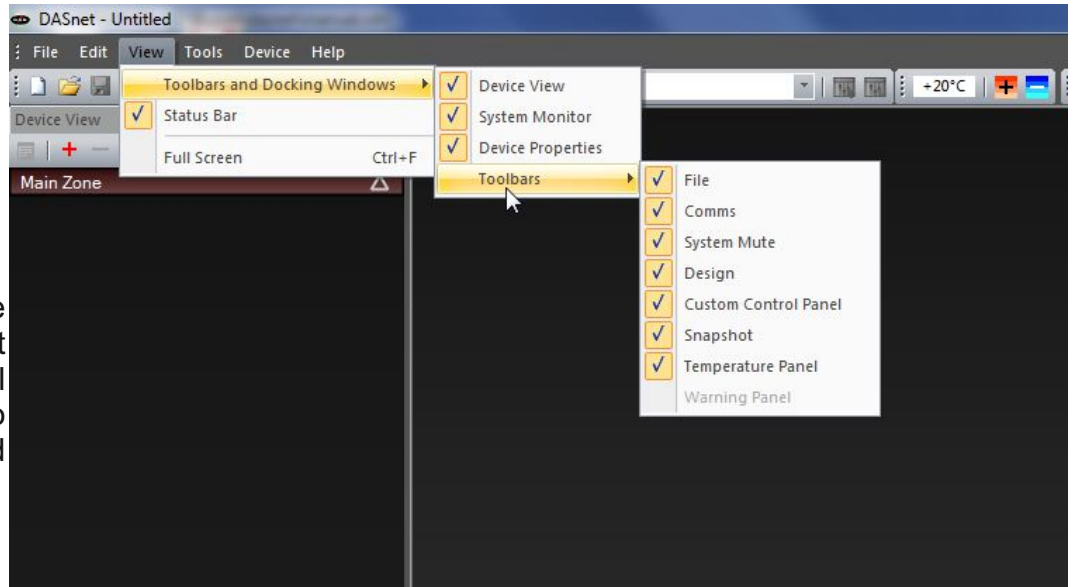

#### Important

On the *tools menu* select the COM port that uses the installed converter to allow communication with the devices (cabinets). **Baud rate must be 57600!!** Besides this, the user can select getting the parameters from the units (retrieve settings) or send the settings to the units from the computer or ask the user everytime the system goes on-line.

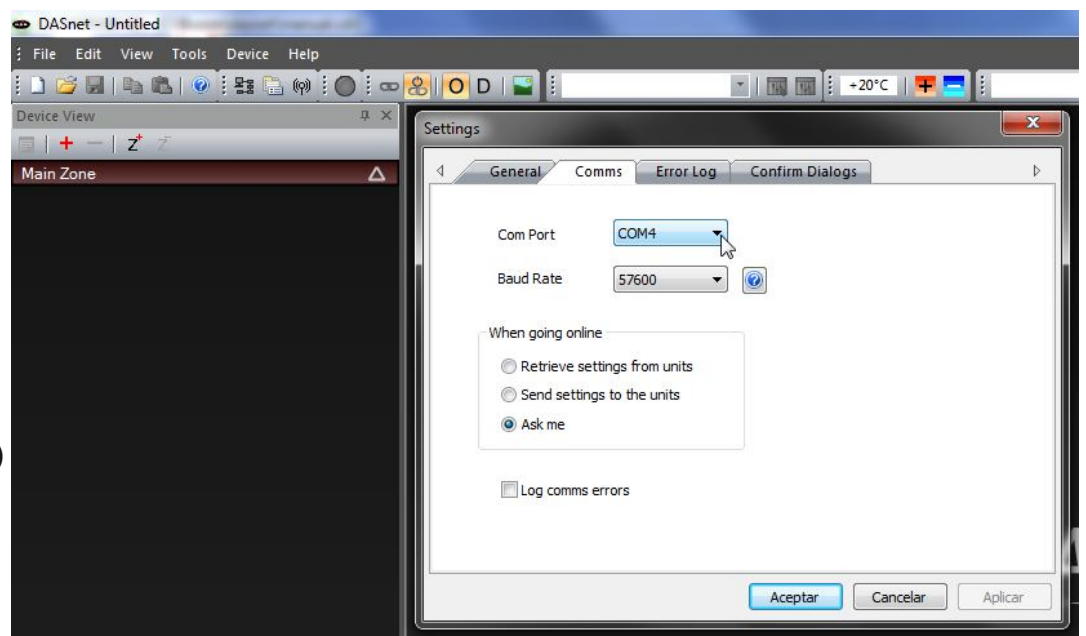

## 4. LAYOUT OF THE MAIN WINDOW

A double click on any *device* will display its “front view” for editing of audio properties. Non-audio properties are shown in the *Properties* panel on the right hand side of the main window.

The screenshot shows the DASnet software interface with several key components highlighted by blue text and arrows:

- Device View:** Located on the left, it lists network cabinets and DSPs. Annotations indicate that cabinets and DSPs are active in the network.
- Cabinet Control Panel:** A window titled "Road 12A - Road12 n°25" is shown, with a note that it is currently active.
- DSP Control Panel:** A window titled "12 aero50 4 Way - ID:3" is shown, with a note that it is currently active.
- Properties Window:** On the right, a panel displays system and amplifier details, including the system's name, amplifier channels, and the DASnet ID number.

In the above example all devices are off-line, as shown by the red indicator on each unit in the Device View and the System Monitor View. When connected and on-line, the indicators will be green. A yellow flashing indicator means there is a problem (like a protection or load error detection) - check on the control panel of the device for more details.

Before looking at the details of a device’s controls and properties, here are a few general pointers about using the software:

- The last saved file can automatically be opened when the software is started by setting the option in the Tools --> Options --> General Tab:

The screenshot shows the DASnet software interface with the Settings dialog box open. The "General" tab is selected, and the "Load last file on startup" checkbox is checked and circled in blue. Other options visible include "Autosave every 1 minutes" and "Check for Updates Automatically". The "Image Library File" path is set to "C:\Users\jnavarro\AppData\Roaming\Core\ImageLib.i".

- Settings can be copied between units either using the buttons on the toolbar (which uses the currently selected cabinet) or by using the right-click context menu on the unit's "front view" or in the Device View:



- The global **System MUTE** Mute works from either the toolbar, menu, or by pressing 'Ctrl +M' on the keyboard.

- The error log is stored to a file called "Logfile.txt" which is stored in the same directory as the program executable file.

## 5. REORGANISING THE WINDOW

To move inner windows about, pick them up by their title bar:

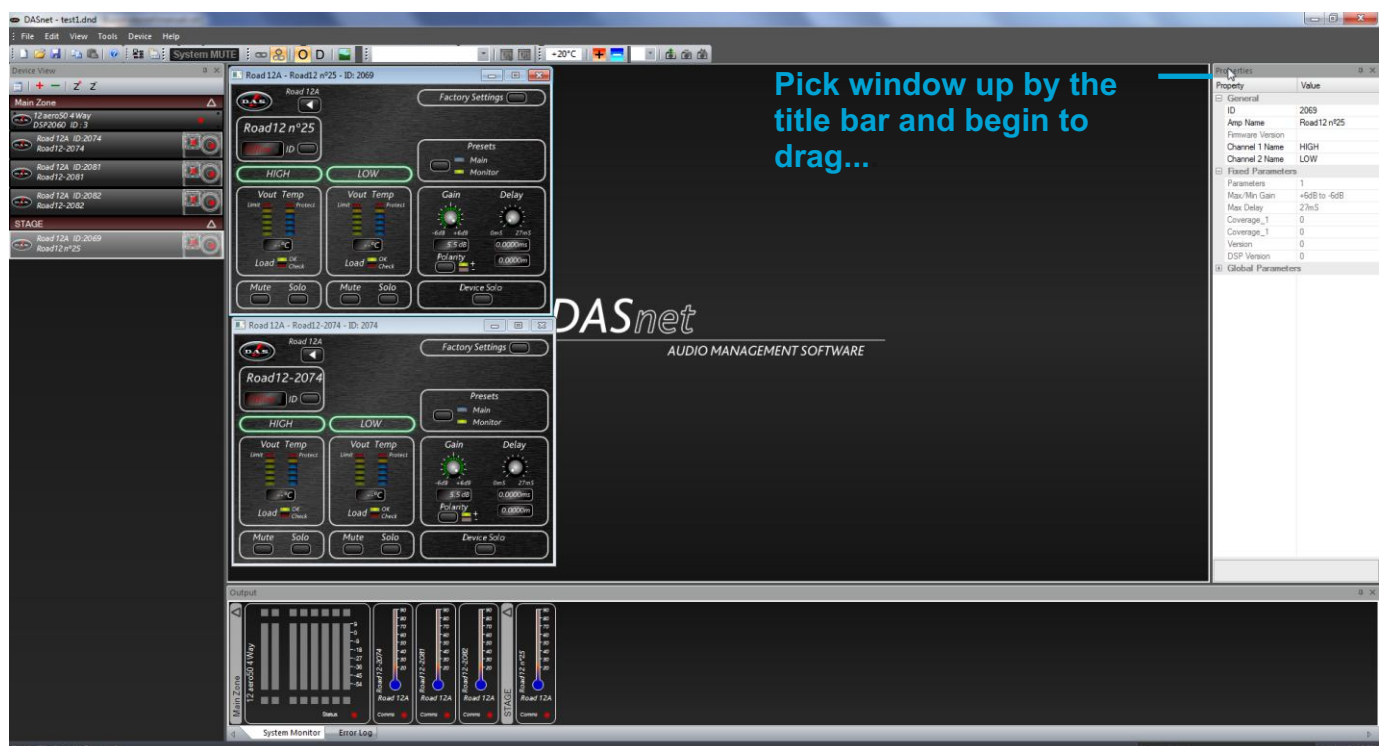



For example to move the properties window and re-dock it, pick up the properties window by its title bar and begin to drag it. This will make a number of docking options anchors appear - these look like this:

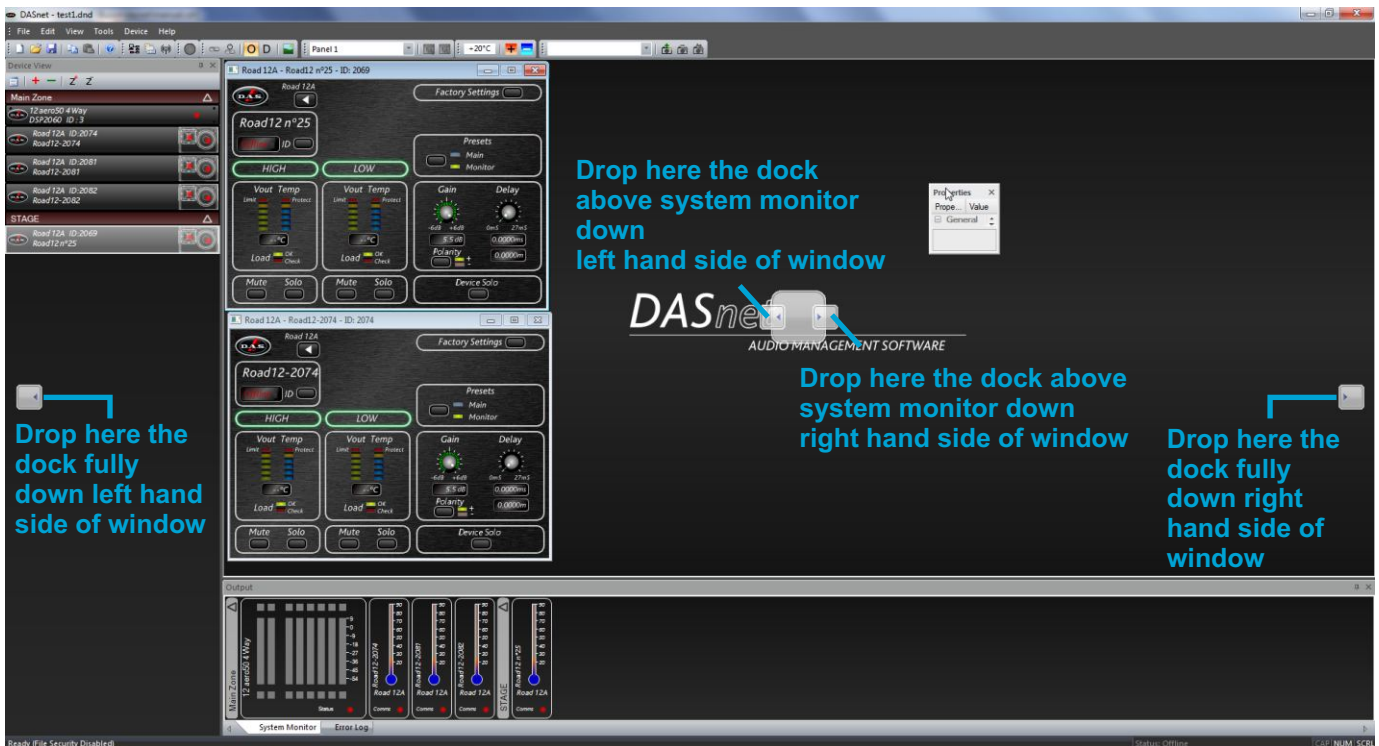

Drop the window on one of the anchors to dock it in the new position, as shown above. Similarly, the system monitor window can be docked either top or bottom of the main window, and either fully across this window, or bracketed by the device view and/or properties window.

The Device View and properties window can be combined into a single tabbed window by picking either up and dragging it directly onto the other window where a new anchor will appear.

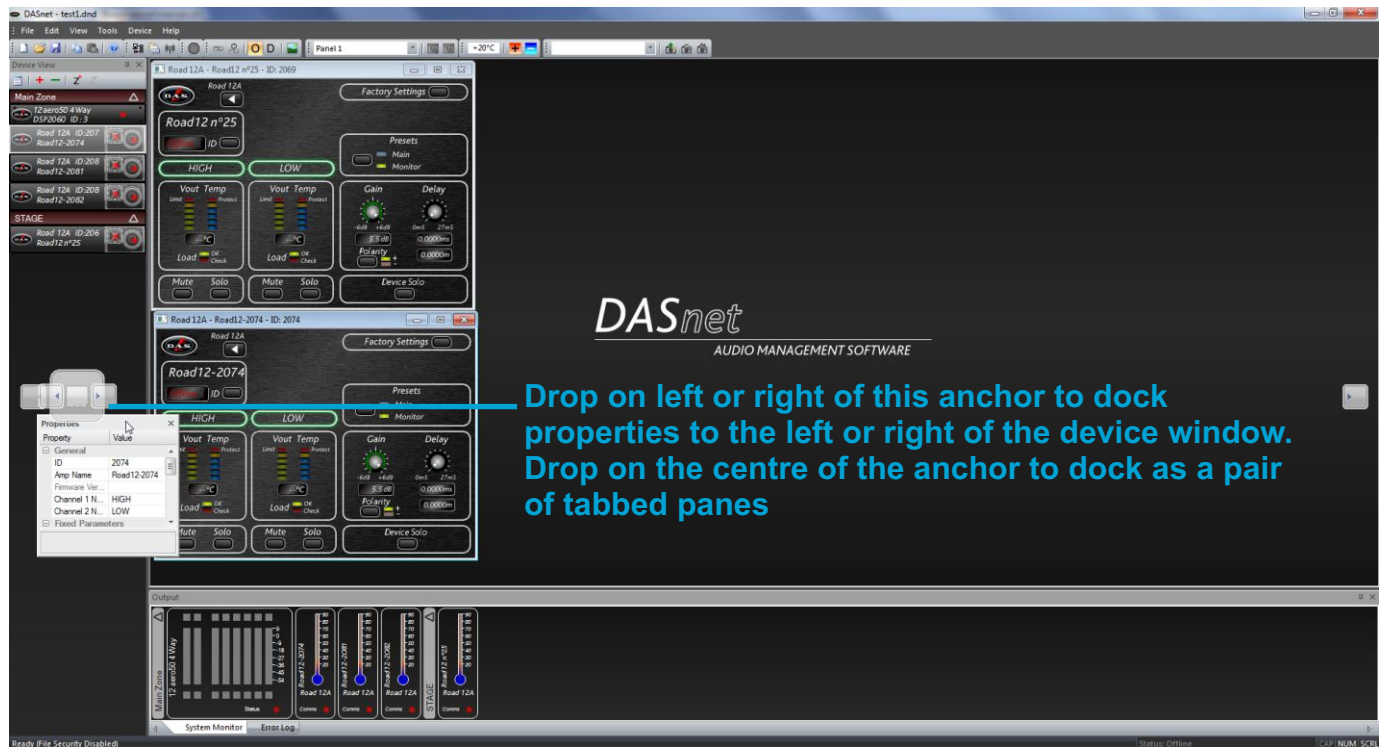

To separate out the windows again, just click on the tab of the window and drag and drop it as required to select a new position.

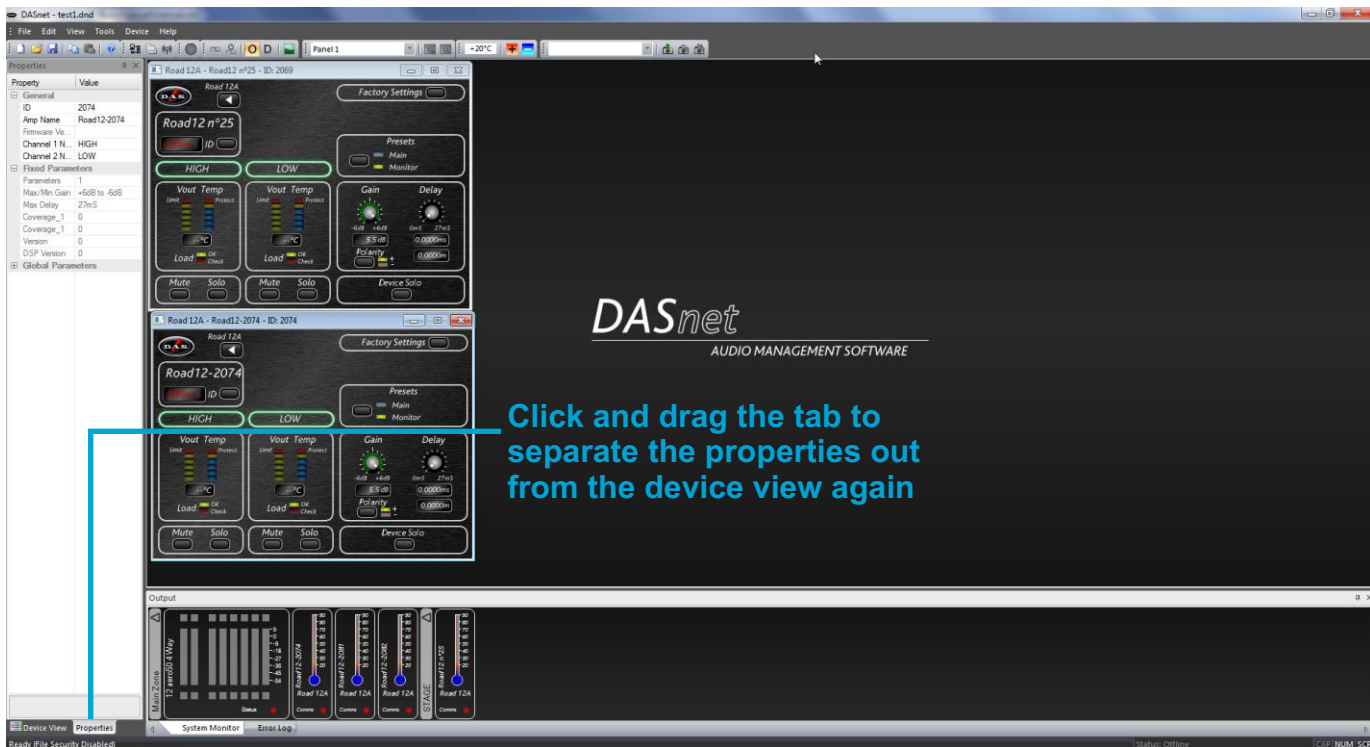

**DASnet**  
AUDIO MANAGEMENT SOFTWARE

Click and drag the tab to separate the properties out from the device view again

Windows can also be left floating by dragging them from their current positions and just dropping them on the main background.

### 6. AUTO-HIDING WINDOWS

All inner windows can be set to “auto hide”, so they disappear into the edge of the main window when not required to maximise available screen area, but make them quickly available if necessary.

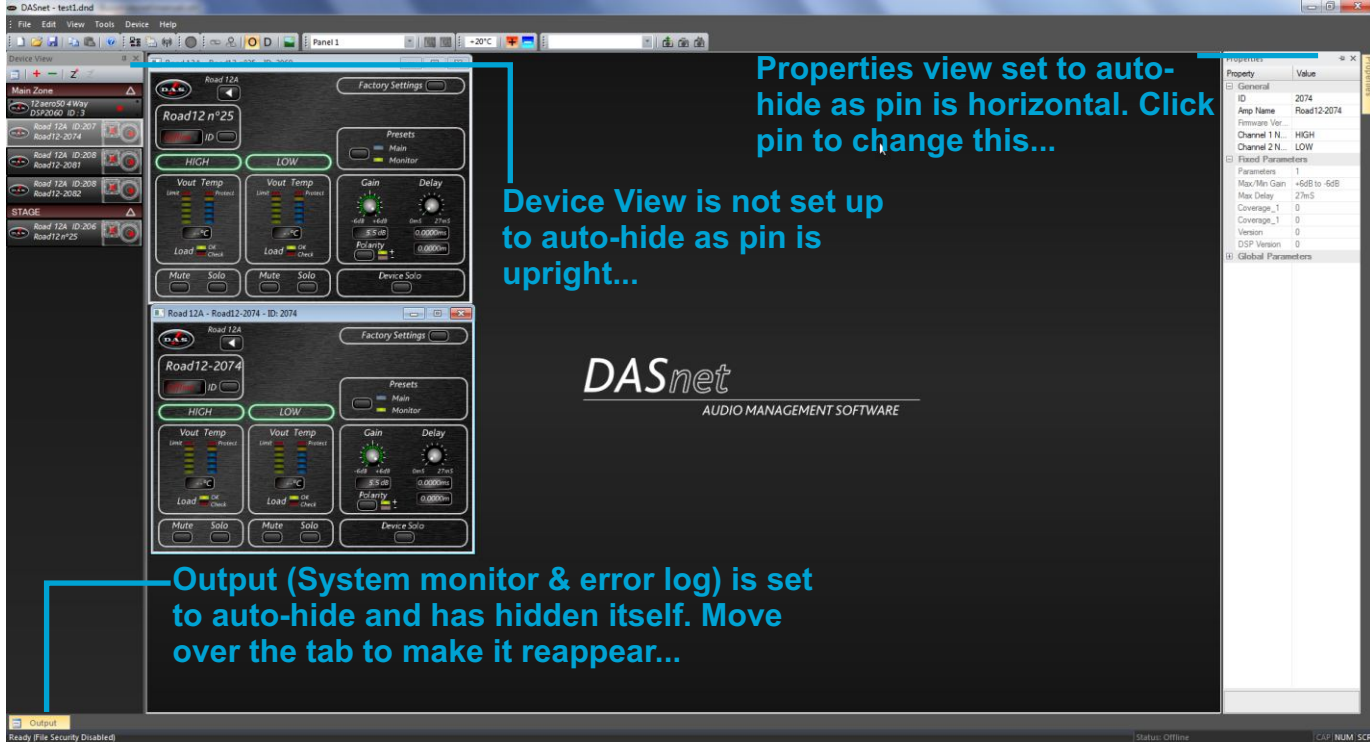

Properties view set to auto-hide as pin is horizontal. Click pin to change this...

Device View is not set up to auto-hide as pin is upright...

Output (System monitor & error log) is set to auto-hide and has hidden itself. Move over the tab to make it reappear...

**DASnet**  
AUDIO MANAGEMENT SOFTWARE

Remember, if any windows have been closed they can be reinstated through the menu View --> toolbars and docking windows.

## 7. ZONING DEVICES

The Zones shown in the Device View and System Monitor windows allow groups of devices to be logically arranged to reflect their physical locations more accurately than just one large list of units.

The example below has different cabinets split into three zones, and units re-ordered to make it easier to locate them on the screen.



Things to know about the zones:

- There is always a master (main) zone, which you can rename (Left PA) but you can never get rid of.
- New zones can be added using the Z+ button at the top of the Device View.
- Devices can be moved into new zones just by clicking on them and dragging them to the required zone. They can also be re-ordered within a zone in the same way.
- Zones can be renamed by double click on their names.
- Zones can be expanded and collapsed using the  in the zone header.
- Files will remember the zone layouts including expand / collapse status when you save them.



## 8. COMMUNICATION WITH THE DEVICES

8.1 The simplest way of adding units to the net is by using the **AutoScan** option (remember to specify the COM port on the *tools / options* menu). The entire process will take approximately 90

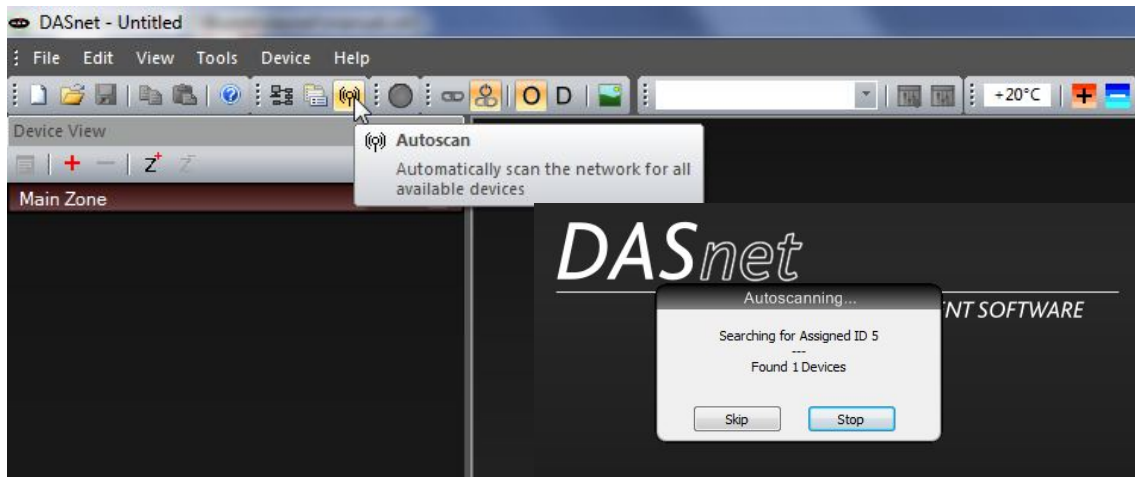

When the scanning process ends, all connected devices (on line) appear on the *device view window* in green.

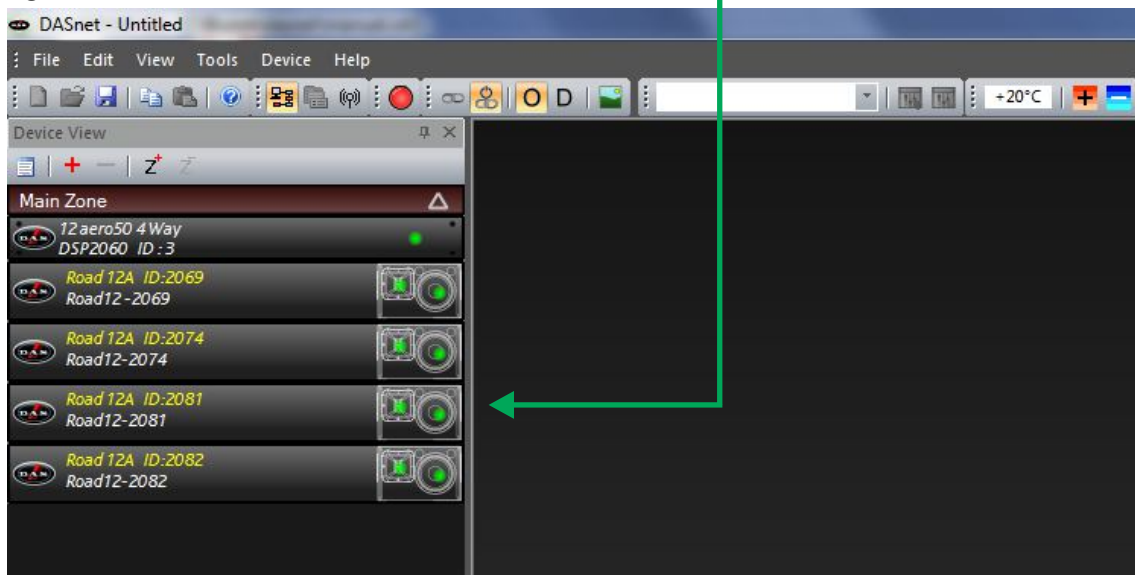

**Important:** only connected devices will appear on the main window. If the communication with any of the devices is lost after being detected, the unit will appear in red colour and physically in the cabinet the Comms / ID led will not light up:

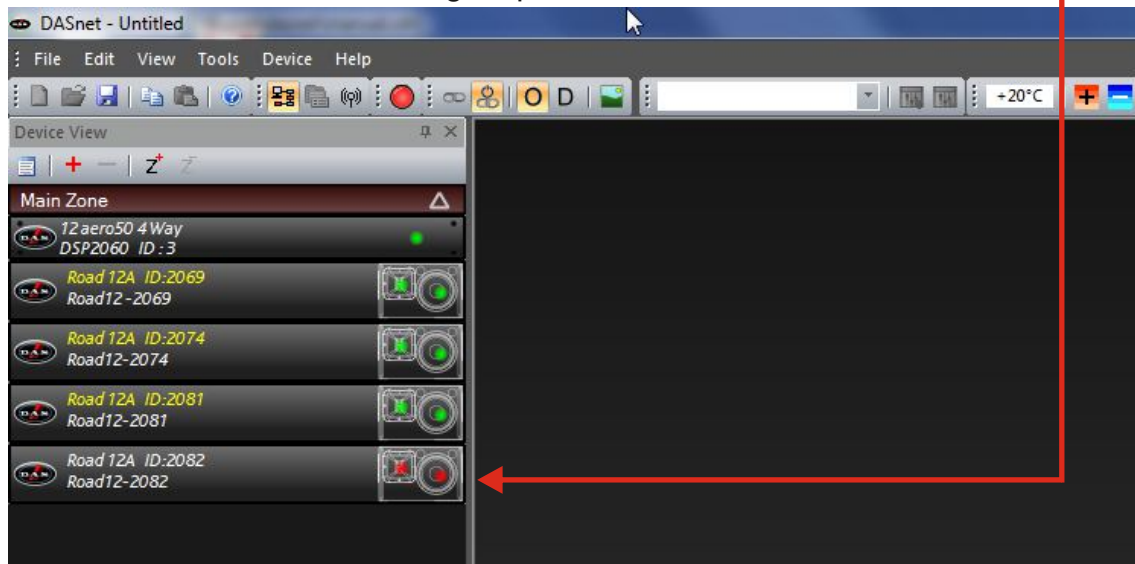

On line devices can be assigned to different zones just by clicking and dragging them. First step is to add new zones and then, rename them. In this case the zone has been named *stage*.



The unit Road 12A ID:2069 has been moved to the Zone named STAGE. Besides this, the unit could be renamed on the properties window (this name will remain in the memory of the device!):

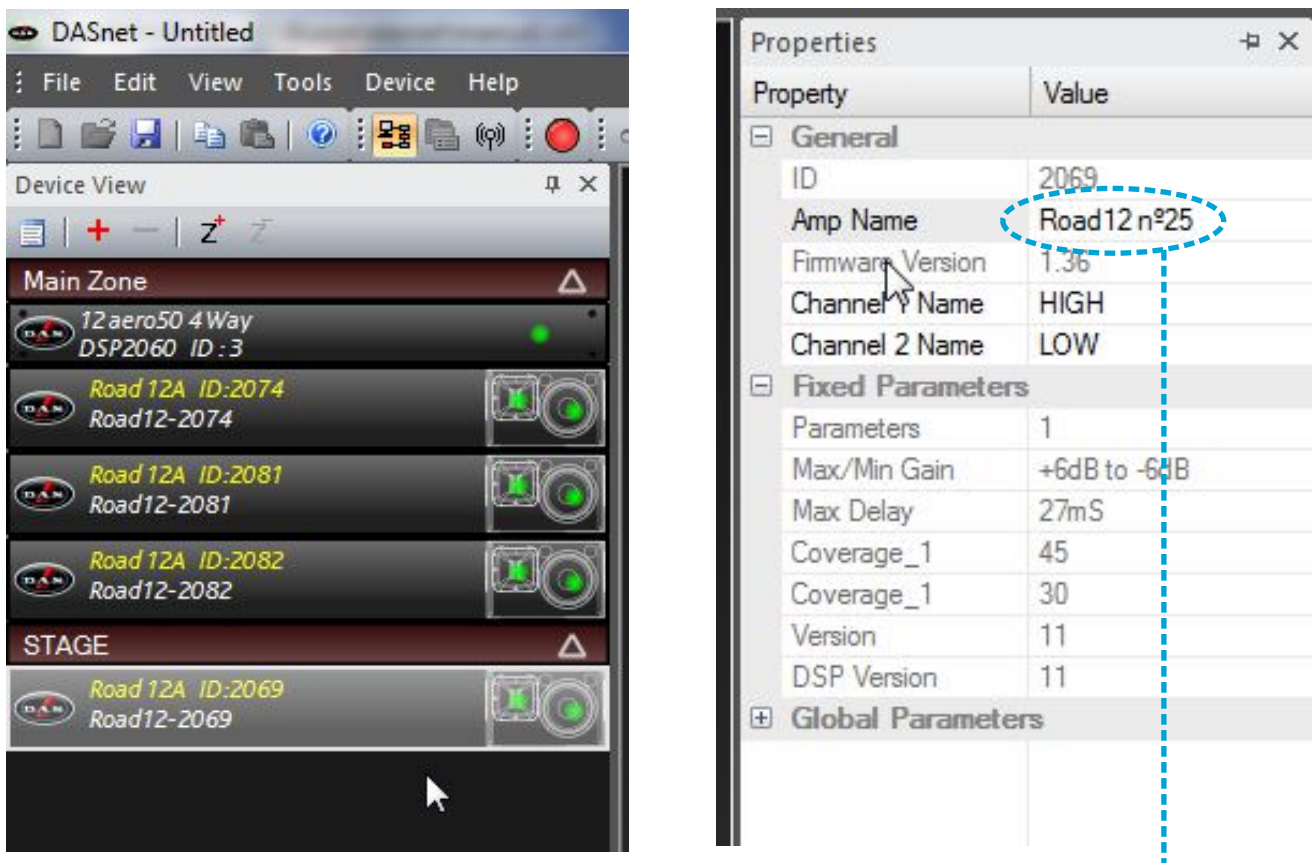

The ID number on the cabinets is unique and will never change. The user can rename the cabinets by using an easier code, for instance numbers: Road 12 n°25 etc



8.2 If the system configuration is always the same, because it is a fixed installation or the set up remains the same between shows, a \*.dnd file can be saved on the computer and the user could work with it as an starting point. Once you have your system ready while communication is running save the file, in this case *test1.dnd*

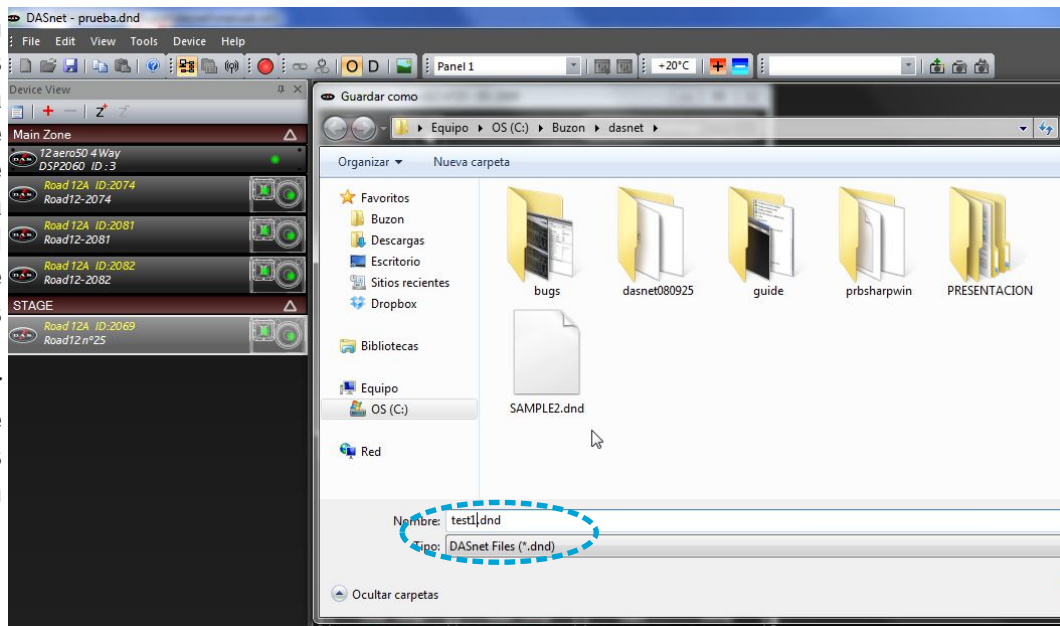

Once the file has been saved close the software and re open it again. Instead of going to the *autoScan* menu, open *test1.dnd* file first:



At this moment the saved configuration has been recalled but still there is NO communication between the computer and the devices. To do that go to ON Line button on the software (Ctrl + Q):



When going on line the software will ask the user:

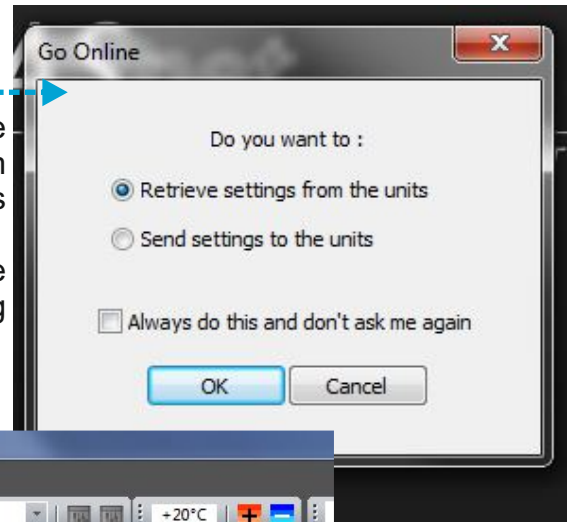

It is up to the user to decide if parameters on the software file have to be sent to the devices (Send) OR settings from the cabinets have to be imported to the software. In this case we will use the settings from the units (Retrieve). Immediately when pressing OK all the units on the *test1.dnd* file will be On Line (without doing the scanning process):



The name of the system can be changed by the user. Once the change is done, the name will remain the same even though a factory settings reset is done.

**IMPORTANT:** The first time the user connects the cabinets with the PC it is highly recommendable to name all your inventory devices with numbers for instance.

**IMPORTANT:** The baud rate must remain at 57600 to ensure compatibility with all connected devices.

**IMPORTANT:** The safest method of connection to avoid accidentally changing any device settings is to select "Retrieve Settings from units" as this will upload all devices properties and parameters to the computer.

**IMPORTANT:** Remember to save your system before closing DASnet to avoid having to rescan the system every time you open the software. All window positions, zones, and screen layouts (so positions of the Device View, Properties and System Monitor) are also saved.



8.3 There is another way of adding (*manually*) devices to the net. If the DASnet ID number of the cabinet is know (it is always on the cabinet’s sticker) just adding a virtual device and setting the ID number on its properties menu the system will automatically connect.

On the graph is shown the net with 3 Road 12A on line:



When being on line a new device (Road 12A ID:0 Device 5) is added and the user writes the ID number on the properties menu:

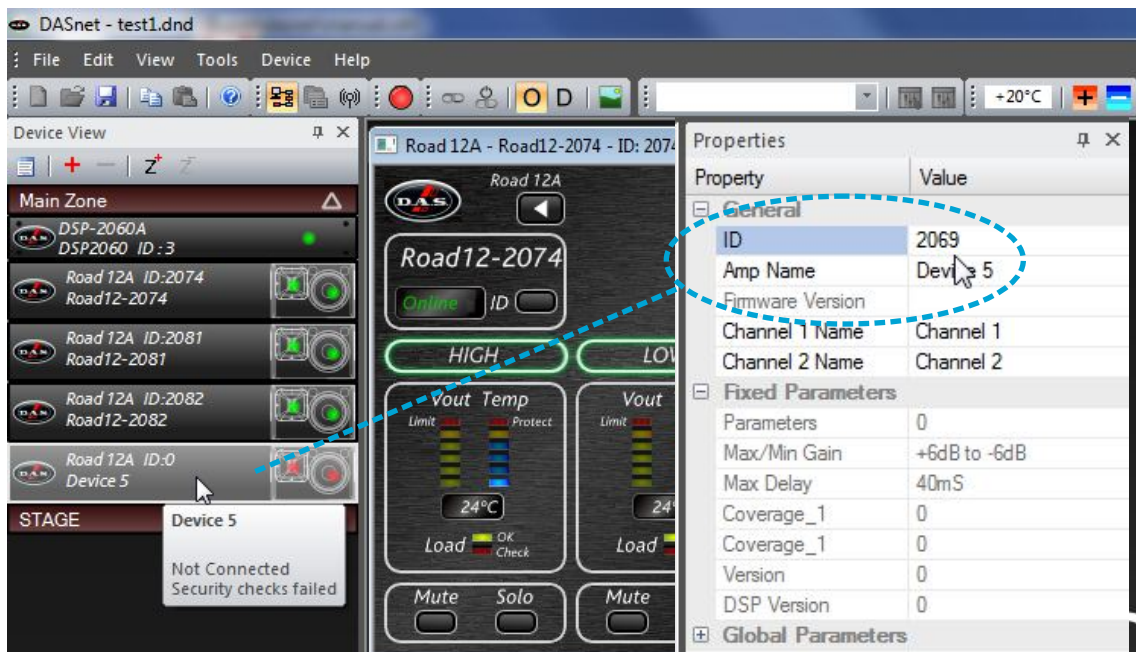

After introducing the ID number and “enter” the cabinet will be on line.

## 9. DEVICE VIEW WINDOWS - cabinets

DASnet has been designed to monitor and control parameters on the connected devices. There are two types of devices, cabinets and digital signal processors.

Cabinets	Processors
Road 12A_net	DSP-2060A
Road 15A_net	DSP-4080
LX-218CA_net	
Convert 15A	
aero 40A	
aero 20A	

### 9.1 Cabinets - Road series

The basic window is activated just by a double click on the device. Example: Device number 25, Road 12A

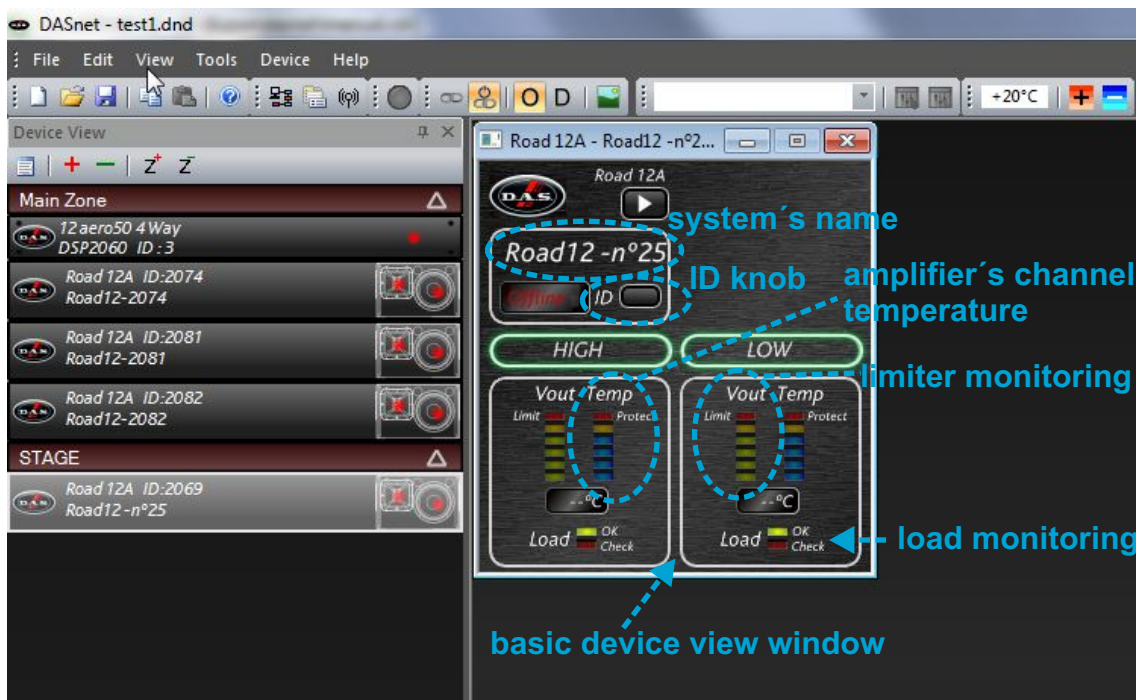

- System's name: defined by the user on the properties window.
- The ID button allows the user to identify the cabinet physically. The ID LED on the amplifier will blink once per second for a few seconds. If communication is working the comms LED will be blinking faster and continuously.

This operation could be done the other way. By pressing the identify knob on the cabinets amplifier the device window on the left main DASnet menu, will blink.

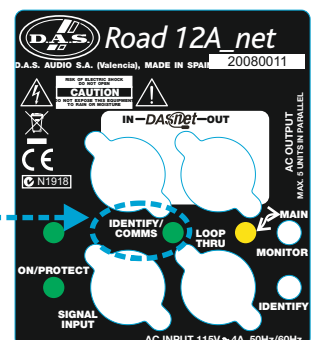

- Amplifier's channel: for each amplifier channel there is a vumeter referred to the limiter threshold. There is also a temperature vumeter that senses amplifiers temperature:

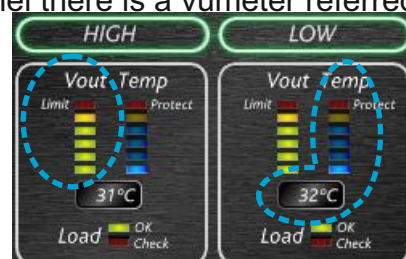



- Load monitoring: for each amplifier channel there is a continuous impedance system control that indicates if the speakers are working properly (green) or not (red):



On the “advanced view” parameters as gain/delay/preset/polarity/mute and solo are available:



- Gain control: this control is for the complete cabinet (not per amplifier channel). From -20dB to +6dB. Value can be entered using the keyboard or the gain control of the software.

- Delay control: this control is for the complete cabinet (not per amplifier channel). From 0ms to 27ms.

- Presets: on the Road series two presets are available: *Main and Monitor*

With the Road series two presets are available. By default (factory settings) the cabinet is a wedge monitor and *Monitor* preset is active. By pressing the button on the cabinet or on the software *Main* preset is activated (*Main* preset boosts low and high end).

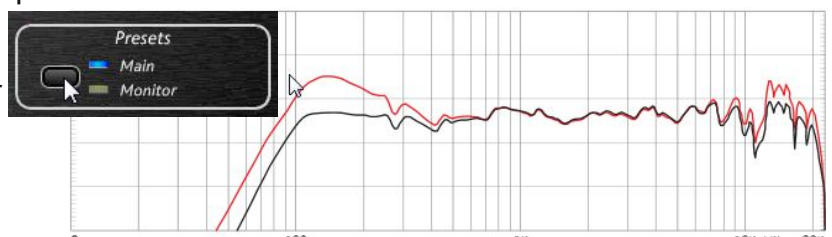

- Polarity: inverts the polarity of the complete cabinet.

- Mute/Solo: per amplifier channel or per cabinet. When SOLO is activated ALL the other devices on the net are muted.

Preset changes are bidirectional so if a preset is changed on the software it will be also changed on the cabinet. And vice versa, a change on the cabinet will be shown as well on the software.

**IMPORTANT:** all DASnet control parameters (gain, delay, presets, mute, solo...etc) are stored on the micro controller included in the amplifier. This means that after switching off the system all values of the parameters will remain the same in memory for the next time the system is switched on.

For instance: if a cabinet has these settings Gain +3dB, delay 5.033ms:



When it is switched off all values are saved in the internal micro controller memory, so next time the system is powered the parameters remain the same Gain +3dB, delay 5.033ms.

**IMPORTANT:** when the user is not sure about the internal settings in the micro controller (delay, gain etc) the best thing is to do a *factory settings* reset. Factory settings puts all the parameters at zero. Device name will remain the same (in this case Road 12 -n°25). *Monitor* preset will be active.



But also physically by pressing the preset knob (holding during a few seconds) while powering the cabinet (on the Road 12A / 15A and LX-218CA).



## 9.2 Cabinets - Convert 15A

Convert 15 A basic view window; DASnet ID 2114:

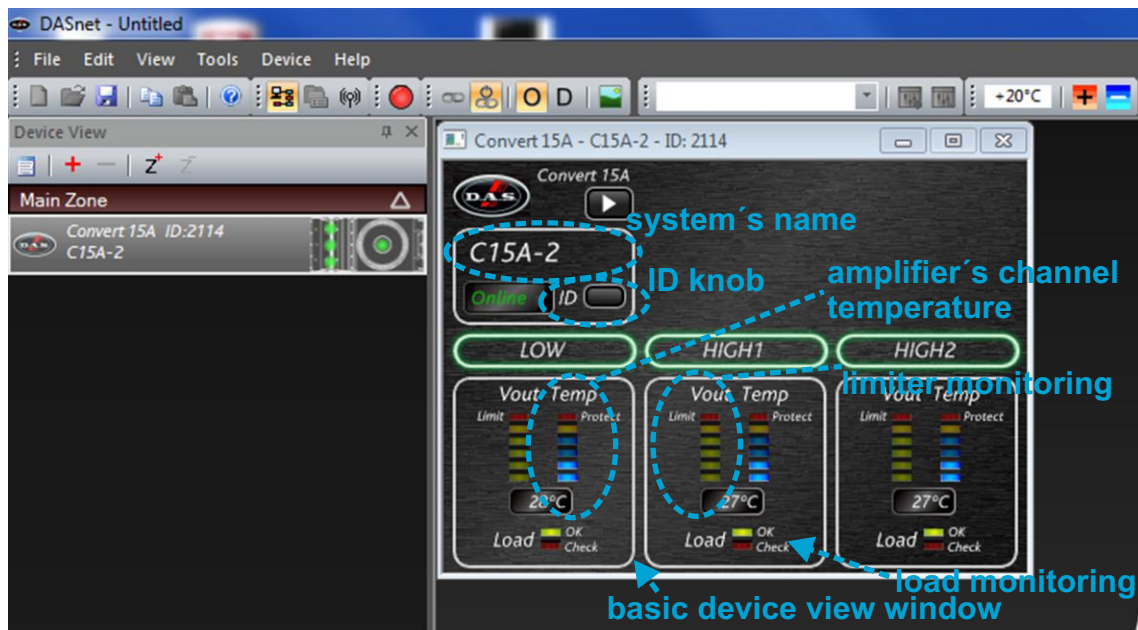

- System's name: defined by the user on the properties window.
- The ID knob allows the user to identify the cabinet physically. The ID LED on the amplifier will blink once per second during a few seconds. If communication is working the comms LED will be blinking faster and permanently.

To identify the cabinet on the software the user should press the button up on the "joystick" of the Convert 15A panel; the device window will blink on DASnet.

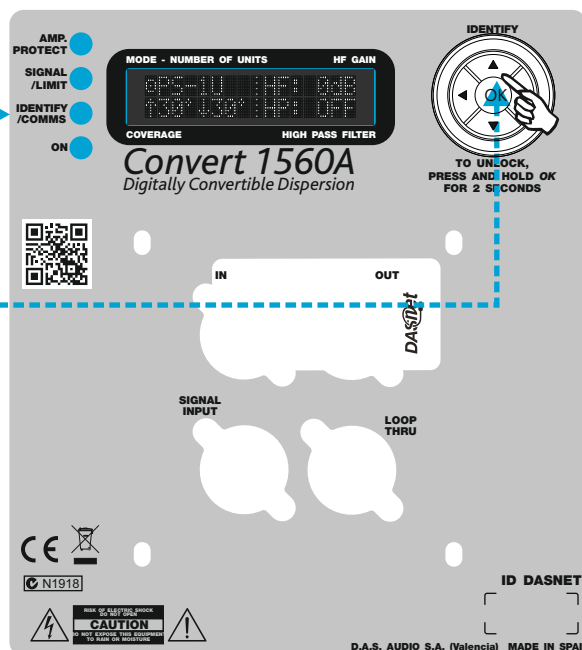

- Amplifier's channel: for each amplifier channel there is a vumeter referred to the limiter threshold. There is also a temperature vumeter that senses amplifier's channel temperature:

**IMPORTANT:** Convert 15A amplifier has been designed to work up to 40°C ambient temperature at clipping conditions. If amplifier's temperature is over 60°C the internal fan will start working. If amplifier's temperature is over 70°C output voltage on the amplifier will be reduced to ensure its durability.

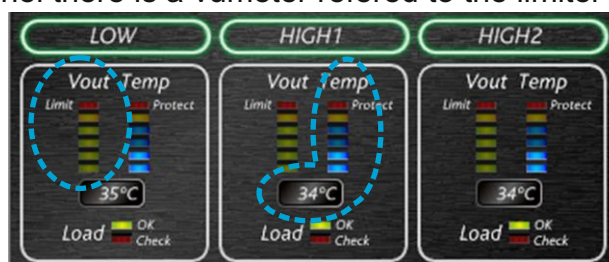

- Load monitoring: for each amplifier channel there is an impedance system control that indicates if the speakers are working properly (green) or not (red):

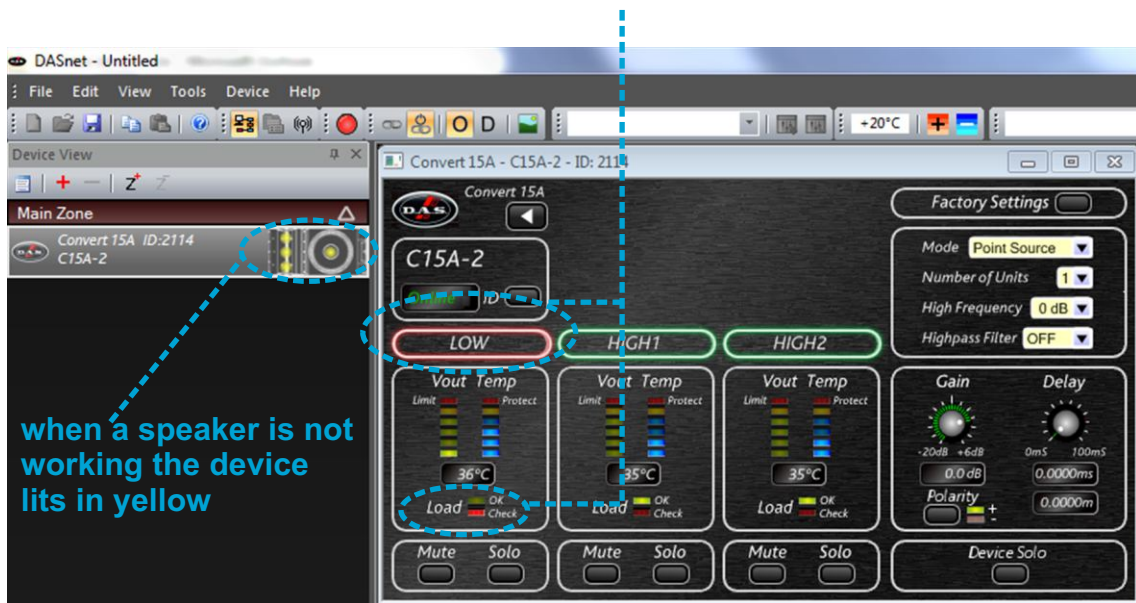

On the “advanced view” parameters as gain/delay/preset/polarity/mute and solo are available:



- Gain control: this control is for the complete cabinet (not per amplifier channel). From -20dB to +6dB. Value can be entered using the keyboard or the gain control of the software.
- Delay control: this control is for the complete cabinet (not per amplifier channel). From 0ms to 100ms.
- Polarity: inverts the polarity of the complete cabinet.
- Mute/Solo: per amplifier channel or per cabinet. When SOLO is activated ALL the other devices on the net are muted.



- Presets on the Convert 15A, 36 presets are available (see user's manual for more details).  
 Preset can be changed using DASnet or the panel "joystick".  
 Here are listed the DASnet preset selection possibilities:

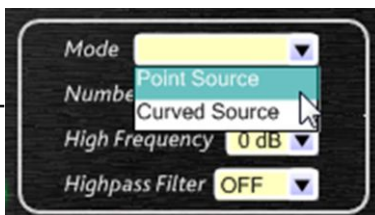
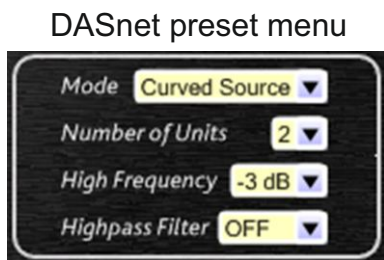

Mode selection  
 Point Source (PS)  
 Curved Source (CS)

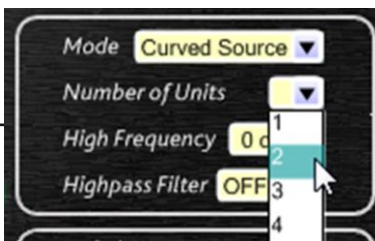

Number of Units  
 on PS mode fixed to 1  
 on CS mode up to 4 units in the array

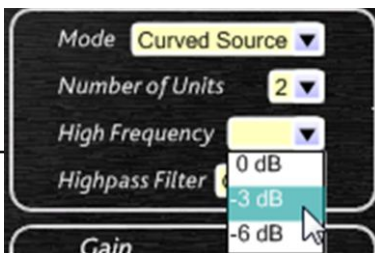

High Frequency (for array Shading)  
 controls the gain of the compression drivers  
 Can be set up at 0, -3dB or -6dB

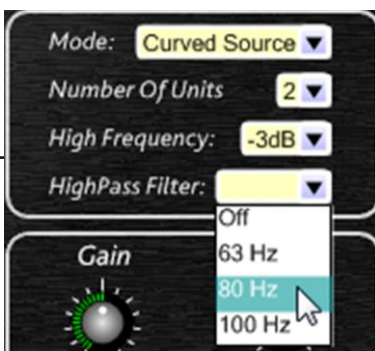

High Pass Filter (48dB/oct)  
 OFF (there is an internal X-over at 50Hz)  
 63Hz  
 80Hz  
 100Hz

Preset changes are bidirectional so if a preset is changed on the software it will be also changed on the cabinet. And vice-versa, a change on the cabinet will be shown as well on the software.

**IMPORTANT:** all DASnet control parameters (gain, delay, presets, mute, solo...etc) are stored on the micro controller included in the amplifier. This means that after switching off the system all values of the parameters will remain the same in memory for the next time the system is switched on.

**IMPORTANT:** when the user is not sure about the internal settings in the micro controller (delay, gain etc) the best thing is to do a *factory settings* reset. Factory settings puts all the parameters at zero. Device name will remain the same (in this case C15A-2).

Factory settings reset can be done via software: (check that gain and delay are set up at zero)

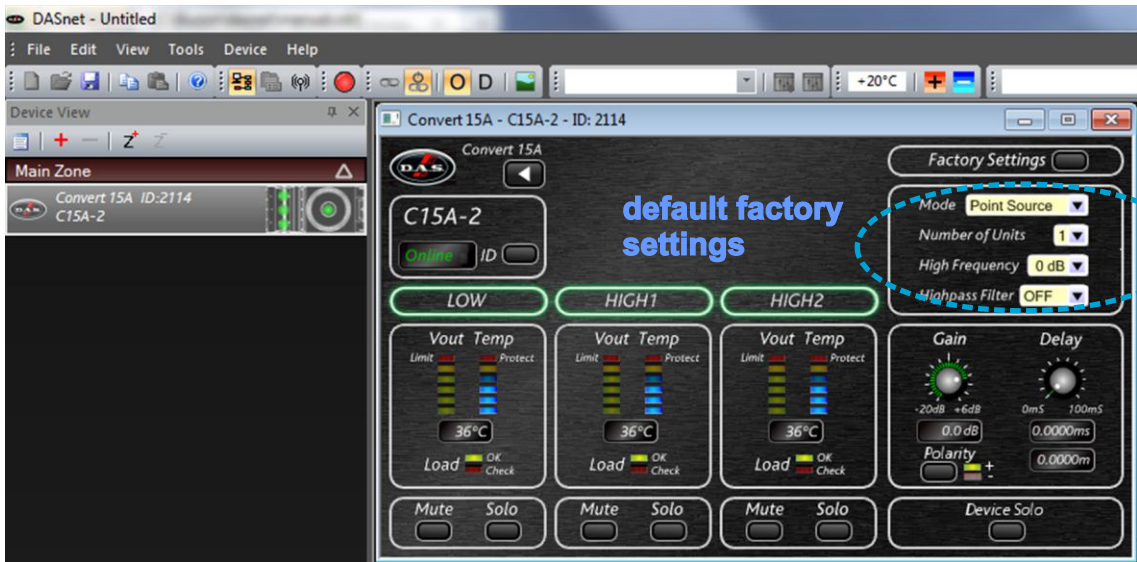

**IMPORTANT:** The default or *factory settings* on the Convert 15A are:

- Mode: Point Source**
- Number of Units: 1 Unit**
- High Frequency: 0dB**
- Highpass Filter: OFF**

Physically if the user wants to do a reset or factory settings, the control joystick and the display has to be used:

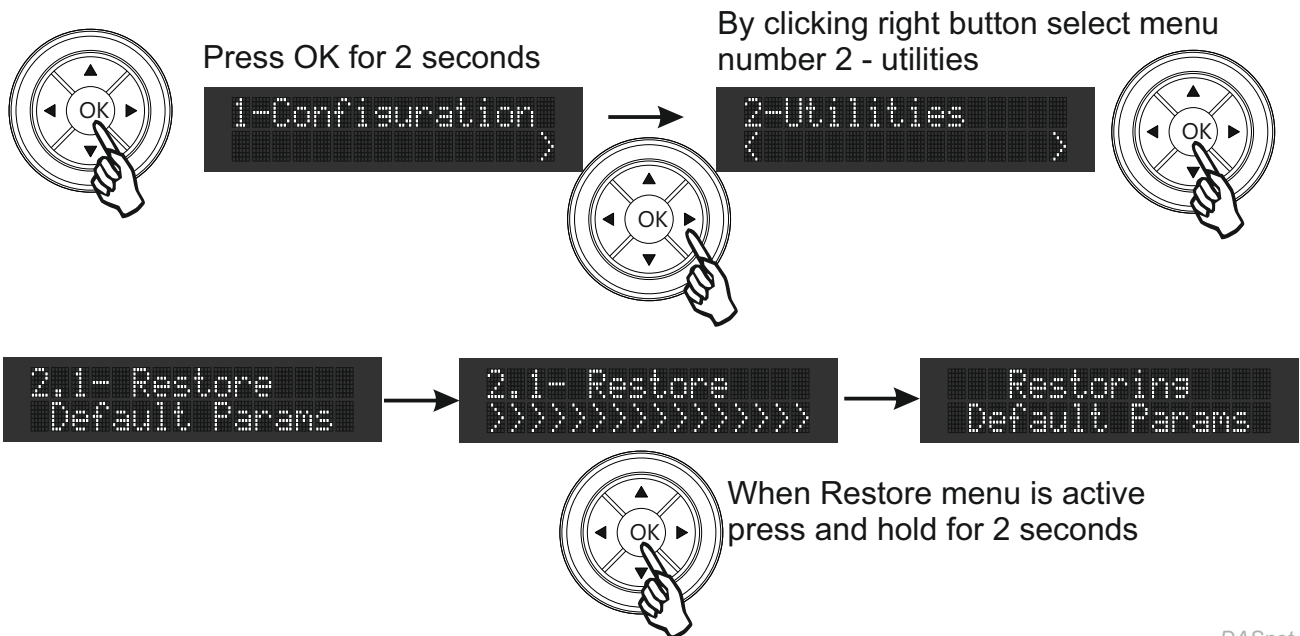

### 9.3 Cabinets - aero 40A

aero 40A basic view window; DASnet ID 2405:



- System's name: defined by the user on the properties window.
- The ID knob allows the user to identify the cabinet physically. The ID LED on the amplifier will blink once per second during a few seconds. If communication is working the comms LED will blink faster and permanently.

To identify the cabinet on the software the user should press the button up on the "joystick" of the Convert 15A panel; the device window will blink on DASnet.

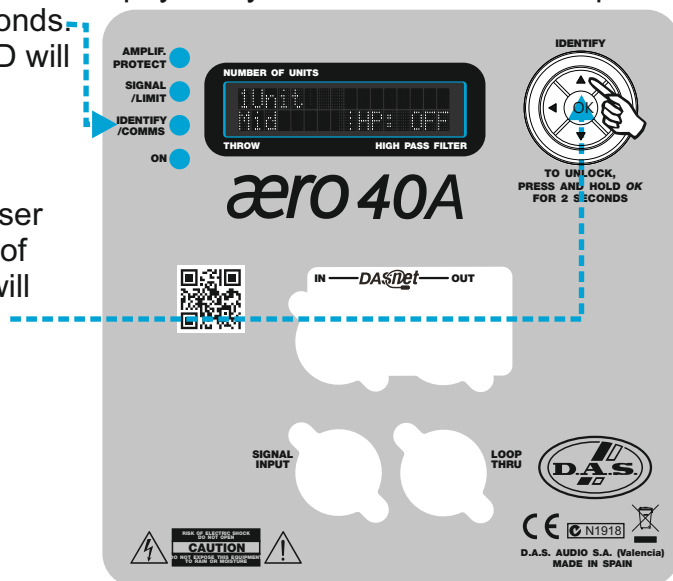

- Amplifier's channel: for each amplifier channel there is a vumeter referred to the limiter threshold. There is also a temperature vumeter that senses amplifier's channel temperature:

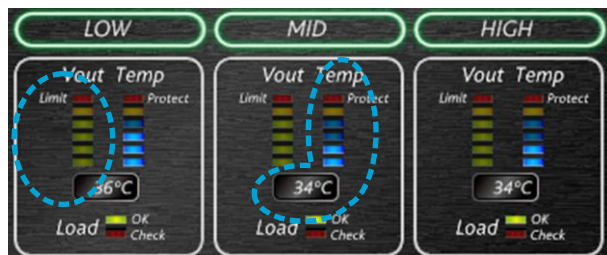

**IMPORTANT:** aero 40A amplifier has been designed to work up to 40°C ambient temperature at clipping conditions. If amplifier's temperature is over 60°C the internal fan will start working. If amplifier's temperature is over 70°C output voltage on the amplifier will be reduced to ensure its durability.

- Load monitoring: for each amplifier channel there is an impedance system control that indicates if the speakers are working (green) or not (red), as it happens on the other cabinet models (see Convert 15A or Road series).

On the “advanced view” parameters as gain/delay/preset/polarity/mute and solo are available:



advanced device view window ----->

- Gain control: this control is for the complete cabinet (not per amplifier channel). From -20dB to +6dB. Value can be entered using the keyboard or the gain control of the software.
- Delay control: this control is for the complete cabinet (not per amplifier channel). From 0ms to 100ms.
- Polarity: inverts the polarity of the complete cabinet.
- Mute/Solo: per amplifier channel or per cabinet. When SOLO is activated ALL the other devices on the net are muted.



- Presets on the aero 40A, 200 presets are available (see user's manual for more details).  
 Preset can be changed using DASnet or the panel "joystick".  
 Here are listed the DASnet preset selection possibilities:



**Number of Units**

Selects the number of cabinets in the array compensating the acoustical coupling for low and mid range with different Low Shelf gain filters:

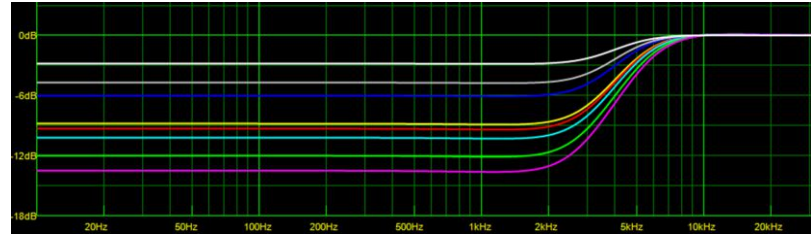

**DASnet preset menu**

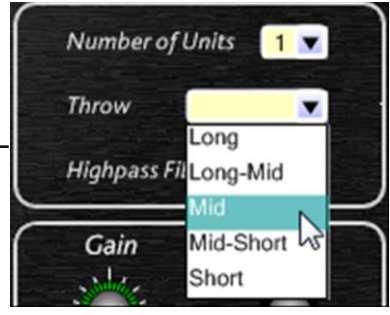
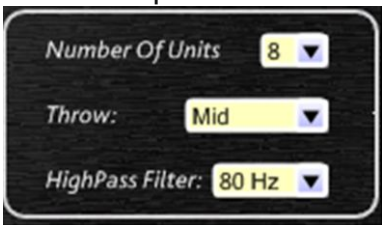

**Throw**

5 presets are available. It enables a High Shelf EQ to have a more uniform distribution over the distance

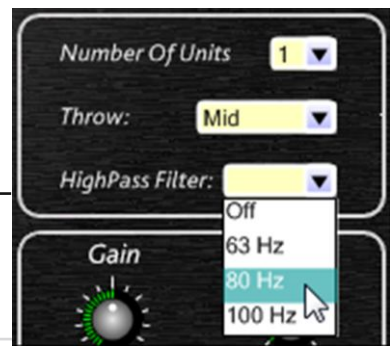
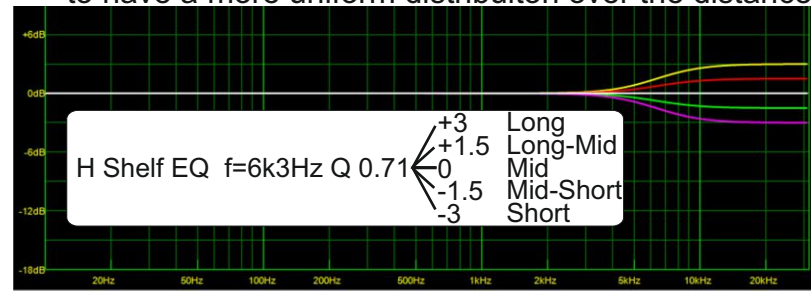

**High Pass Filter (48dB/oct)**  
 OFF (there is an internal X-over at 45Hz)  
 63Hz  
 80Hz  
 100Hz

Preset changes are bidirectional so if a preset is changed on the software it will be also changed on the cabinet. And vice versa, a change on the cabinet will be shown as well on the software.

**IMPORTANT:** all DASnet control parameters (gain, delay, presets, mute, solo...etc) are stored on the micro controller included in the amplifier. This means that after switching off the system all values of the parameters will remain the same in memory for the next time the system is switched on.

**IMPORTANT:** when the user is not sure about the internal settings in the micro controller (delay, gain etc) the best thing is to do a *factory settings* reset. Factory settings puts all the parameters at zero. Device name will remain the same (in this case aero 40A-15).  
 Factory settings reset can be done via software: (check that gain and delay are set up at zero)



**IMPORTANT:** The default or *factory settings* on the aero 40A are:

- Number of Units: 1 Unit**
- Throw: Mid Throw**
- Highpass filter: OFF**

Physically if the user wants to do a reset or factory settings, the control joystick and the display has to be used:

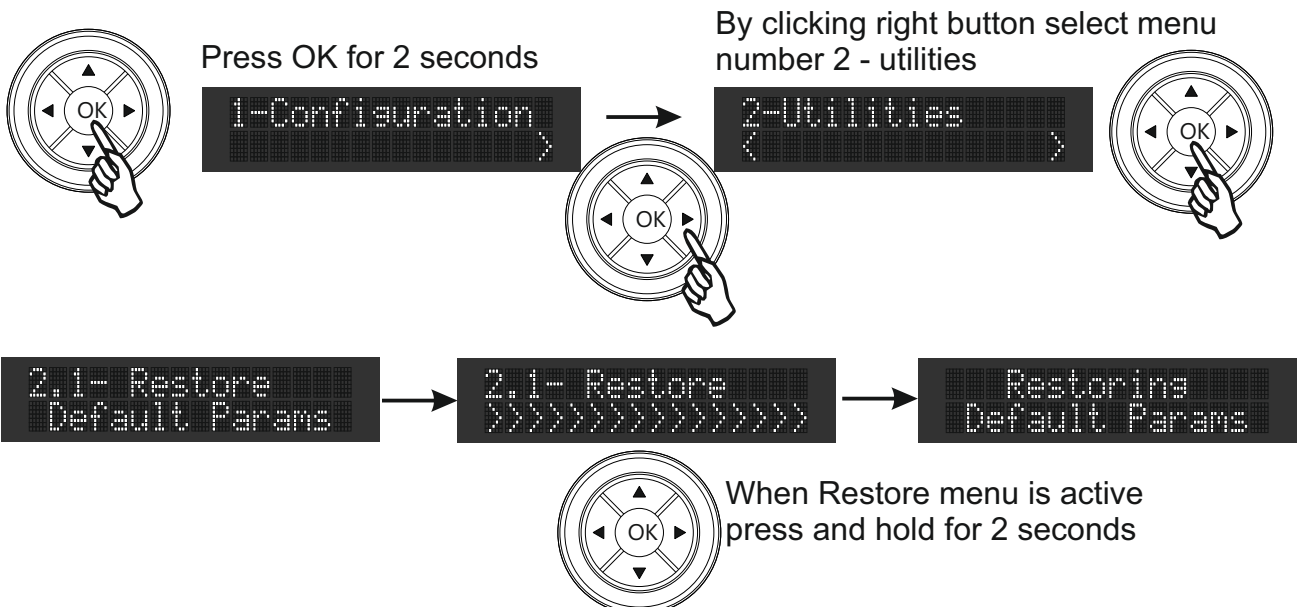

## 9.4 LX-218CA\_net

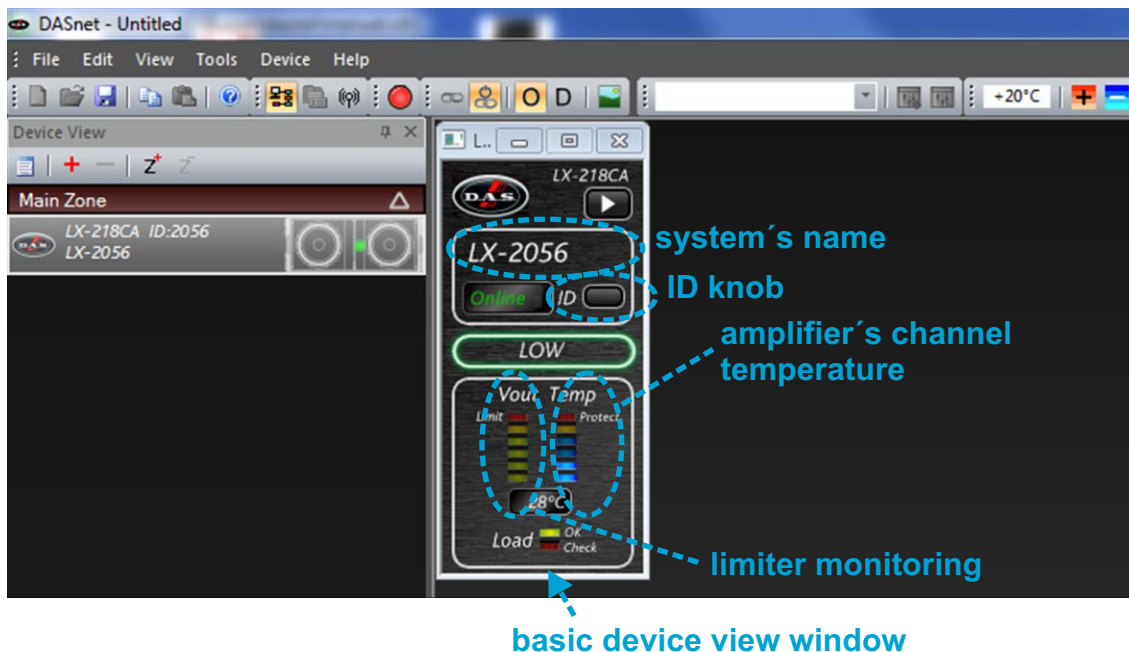

- System's name: defined by the user on the properties window.
- The ID knob allows the user to identify the cabinet physically. The ID LED on the amplifier will blink once per second during a few seconds. If communication is working the comms LED will be blinking faster and permanently.

To identify the cabinet on the software the user should press identify knob on the amplifier panel; the device window will blink on DASnet.

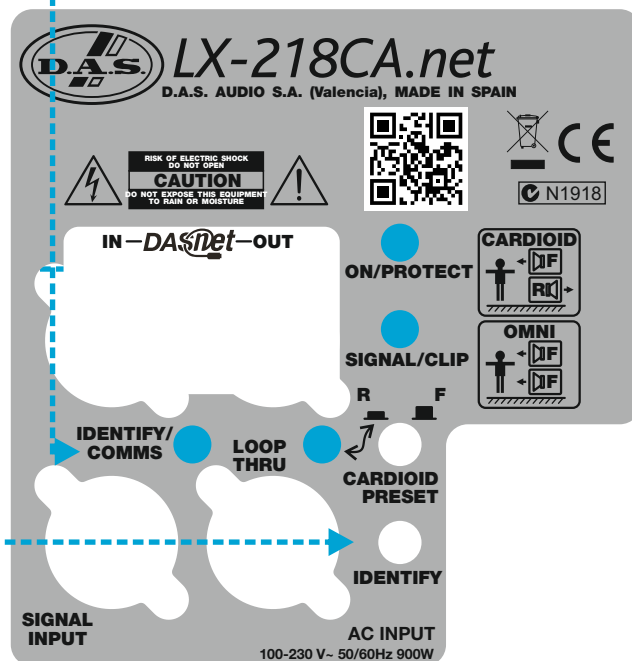

- Amplifier's channel: for each amplifier channel there is a vumeter referred to the limiter threshold. There is also a temperature vumeter that senses amplifiers temperature:

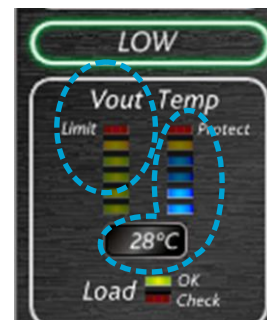

- Load monitoring: for each amplifier channel there is an impedance system control that indicates if the speakers are working (green) or not (red):



On the “advanced view” parameters as gain/delay/preset/polarity/mute and solo are available:



**advanced device view window** ----->

- Gain control: this control is for the complete cabinet (not per amplifier channel). From -20dB to +6dB. Value can be entered using the keyboard or the gain control of the software.
- Delay control: this control is for the complete cabinet (not per amplifier channel). From 0ms to 34ms.
- Presets: on the LX-218CA\_net two presets are available: *Front and Rear*

When the cabinet’s knob is pressed *rear* preset is active. *Rear* preset must be used only when cabinet is facing backguards in conjunction with other ones facing to the front to create a caridoid subwoofer set up.

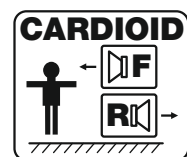

- Polarity: inverts the polarity of the complete cabinet.
- Mute/Solo: per amplifier channel or per cabinet. When SOLO is activated ALL the other devices on the net are muted.



Preset changes are bidirectional so if a preset is changed on the software it will be also changed on the cabinet. And vice versa, a change on the cabinet will be shown as well on the software.

**IMPORTANT:** all DASnet control parameters (gain, delay, presets, mute, solo...etc) are stored on the micro controller included in the amplifier. This means that after switching off the system all values of the parameters will remain the same in memory for the next time the system is switched on.

For instance: if a cabinet has these settings Gain +6dB, delay 15.038ms:



When it is switched off all values are saved in the internal micro controller memory, so next time the system is powered the parameters remain the same Gain +6dB, delay 15.038ms.

**IMPORTANT:** when the user is not sure about the internal settings in the micro controller (delay, gain etc) the best thing is to do a *factory settings* reset. Factory settings puts all the parameters at zero. Device name will remain the same (in this case LX-2056). *Front* preset will be active. Factory settings reset can be done via software: (check that gain and delay are set up at zero)

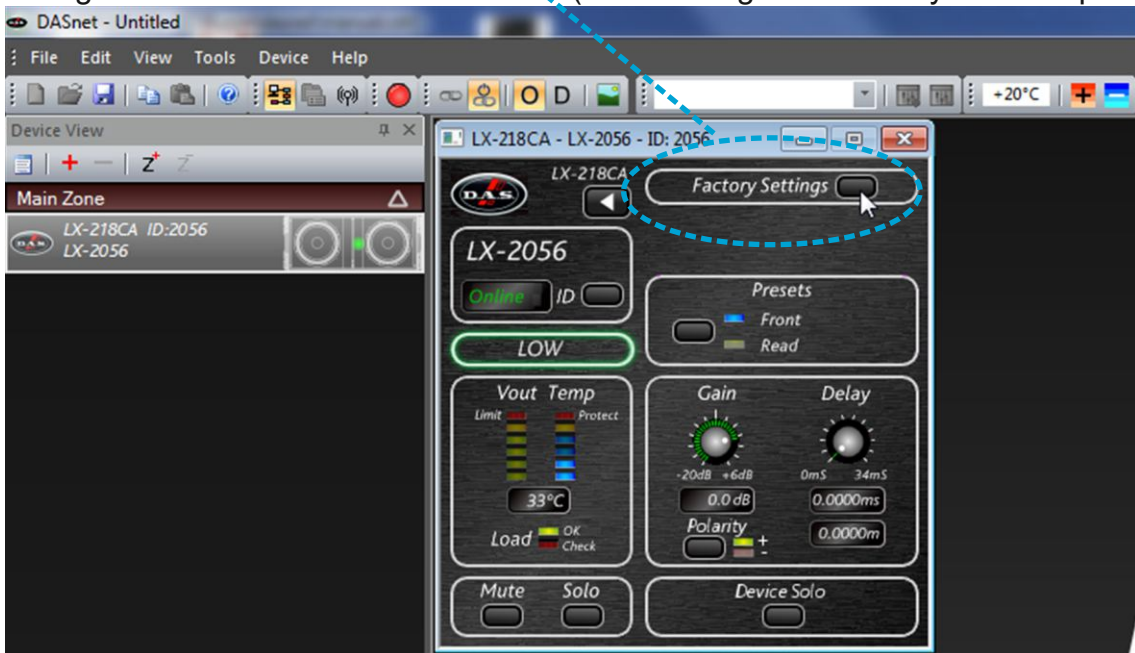

But also physically by pressing the preset knob (holding during a few seconds) while powering the cabinet.

## 9.5 Cabinets - aero 20A

aero 20A basic window; DASnet ID 7237:

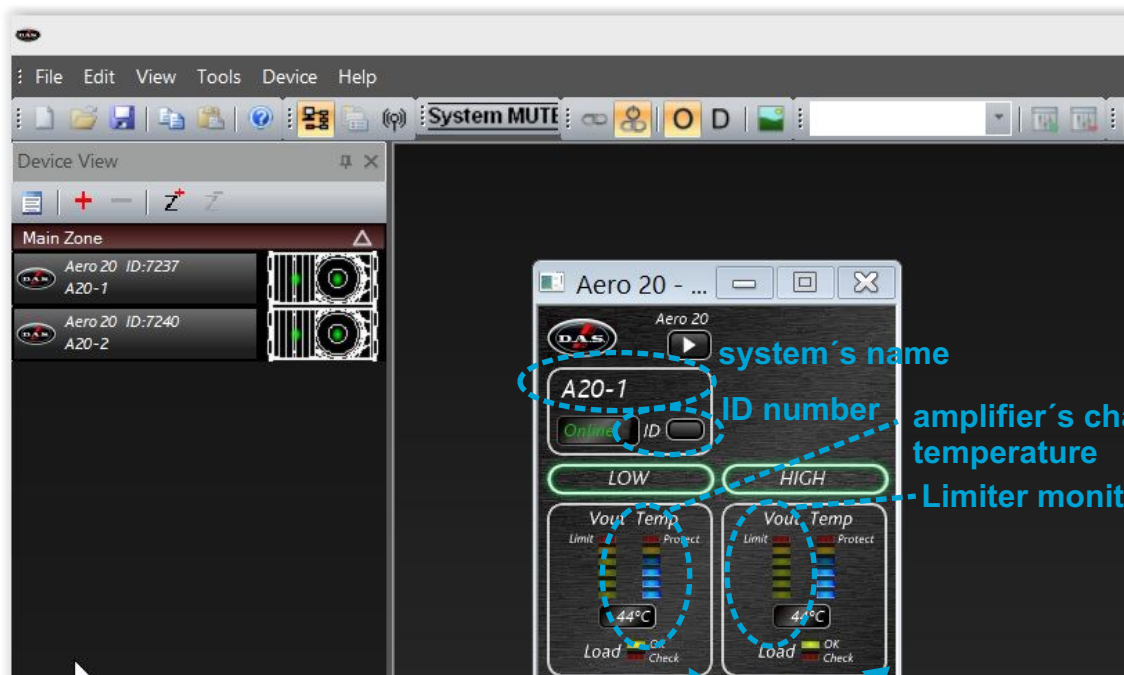

basic window: device view

- System's name: defined by the user on the properties window.
- The ID knob allows the user to identify the cabinet physically. The ID LED on the amplifier will blink once per second during a few seconds. If communication is working the comms LED will blink faster and permanently.

To identify the cabinet on the software the user should press the button on amplifier's panel; the device window will blink on DASnet.

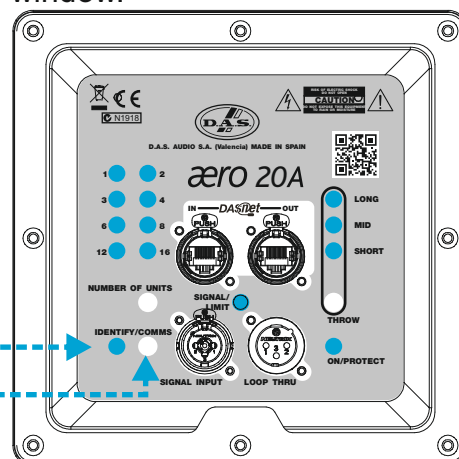

- Amplifier's channel: for each amplifier channel there is a vumeter referred to the limiter threshold. There is also a temperature vumeter that senses amplifier's channel temperature:

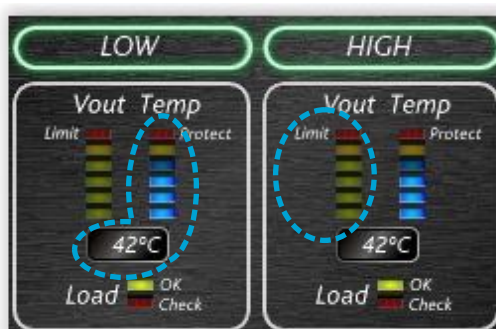

- Load monitoring: for each amplifier channel there is an impedance system control that indicates if the speakers are working (green) or not (red), as it happens on the other cabinet models (see Convert 15A or Road series).

On the “advanced view” parameters as gain/delay/preset/polarity/mute and solo are available:



- Gain control: this control is for the complete cabinet (not per amplifier channel). From -6dB to +6dB. Value can be entered using the keyboard or the gain control of the software.
- Delay control: this control is for the complete cabinet (not per amplifier channel). From 0ms to 28ms.
- Polarity: inverts the polarity of the complete cabinet.
- Mute/Solo: per amplifier channel or per cabinet. When SOLO is activated ALL the other devices on the net are muted.



- Presets on the aero 20A: 24 presets are available for the aero 20A (see user's manual for more details). The default preset (factory settings) sets a flat acoustic response (1unit, Mid Throw). Presets can be selected using the software or the knobs at the amplifier's panel. Here are listed the DASnet preset selection possibilities:

DASnet preset menu

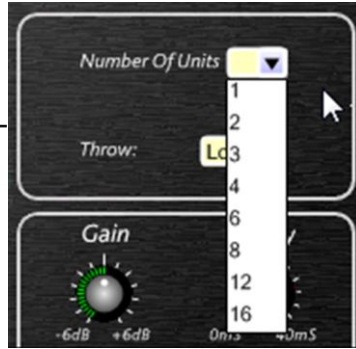

**Number of Units**

Selects the number of cabinets in the array compensating the acoustical coupling for low and mid range with different High Shelf Bell filters:

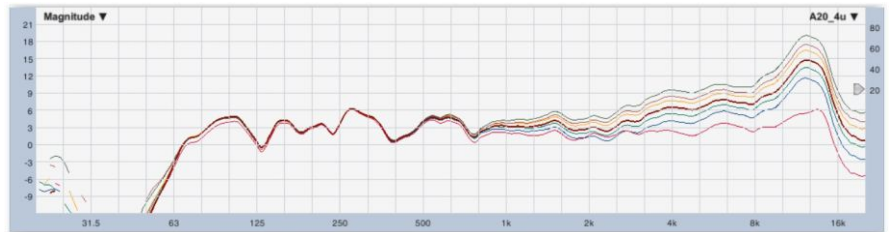

**Throw**

3 presets are available. It enables a High Shelf EQ to have a more uniform distribution over the distance

H Shelf EQ f=2kHz Q 0.71	+3	Long
	0	Mid
	-3	Short

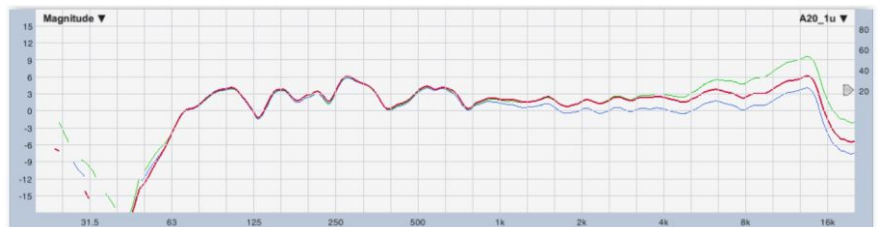

Preset changes are bidirectional so if a preset is changed on the software it will be also changed on the cabinet. And vice versa, a change on the cabinet will be shown as well on the software.

**IMPORTANT:** all DASnet control parameters (gain, delay, presets, mute, solo...etc) are stored on the micro controller included in the amplifier. This means that after switching off the system all values of the parameters will remain the same in memory for the next time the system is switched on.

**IMPORTANT:** when the user is not sure about the internal settings in the micro controller (delay, gain etc) the best thing is to do a *factory settings* reset. Factory settings puts all the parameters at zero. Device name will remain the same (in this case aero 20A-1).  
 Factory settings reset can be done via software: (check that gain and delay are set up at zero)

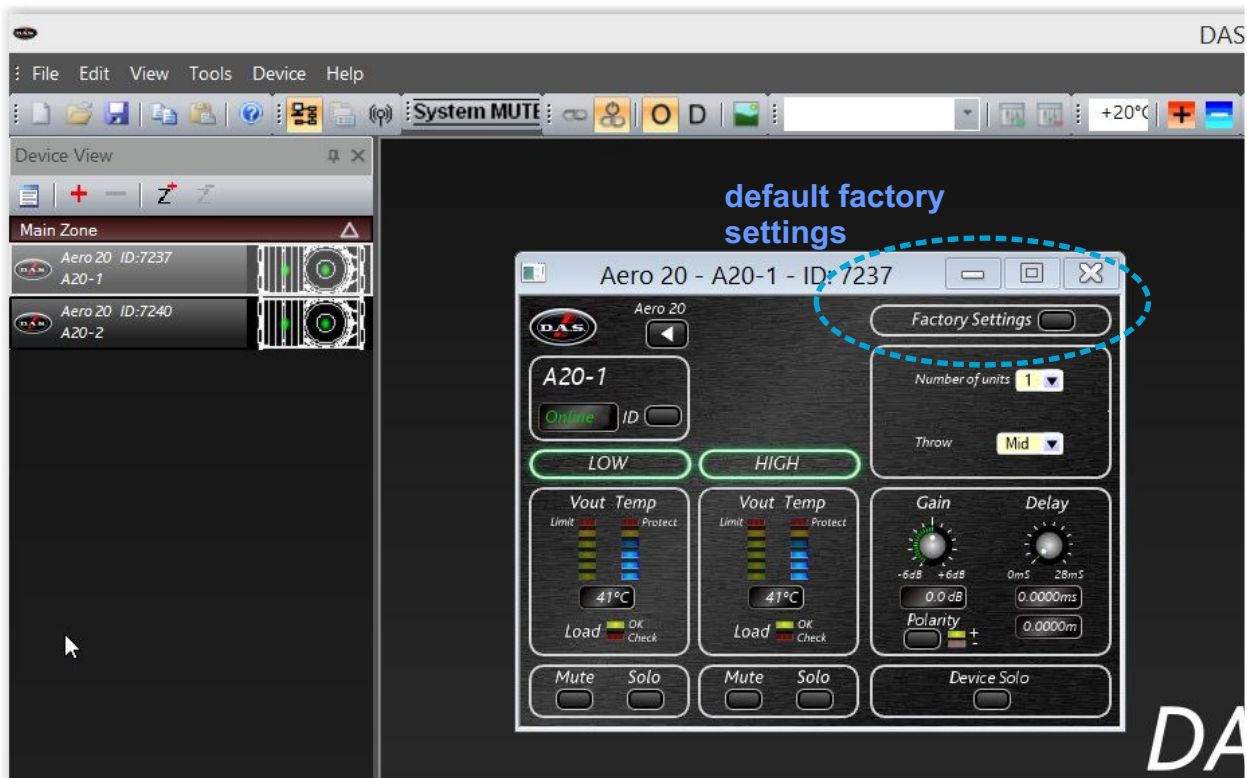

**IMPORTANT:** The default or *factory settings* on the aero 40A are:

**Number of Units: 1 Unit**  
**Throw: Mid Throw**

But also physically by pressing the preset throw knob (holding during a few seconds) while powering the cabinet.

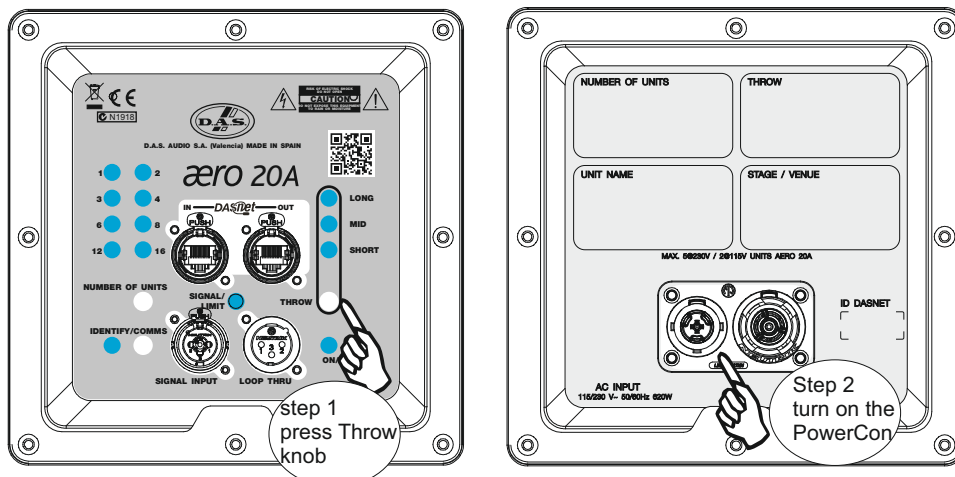

## 10. DEVICE VIEW WINDOWS - processors

DASnet has been designed to monitor and control parameters on the connected devices. There are two types of devices, cabinets and processors.

### Processors

DSP-2060A

DSP-4080

The DSP window on DASnet has three main options: *mixer*, *input EQ* and *output EQ*:

*mixer*

*input EQ*

*output EQ*

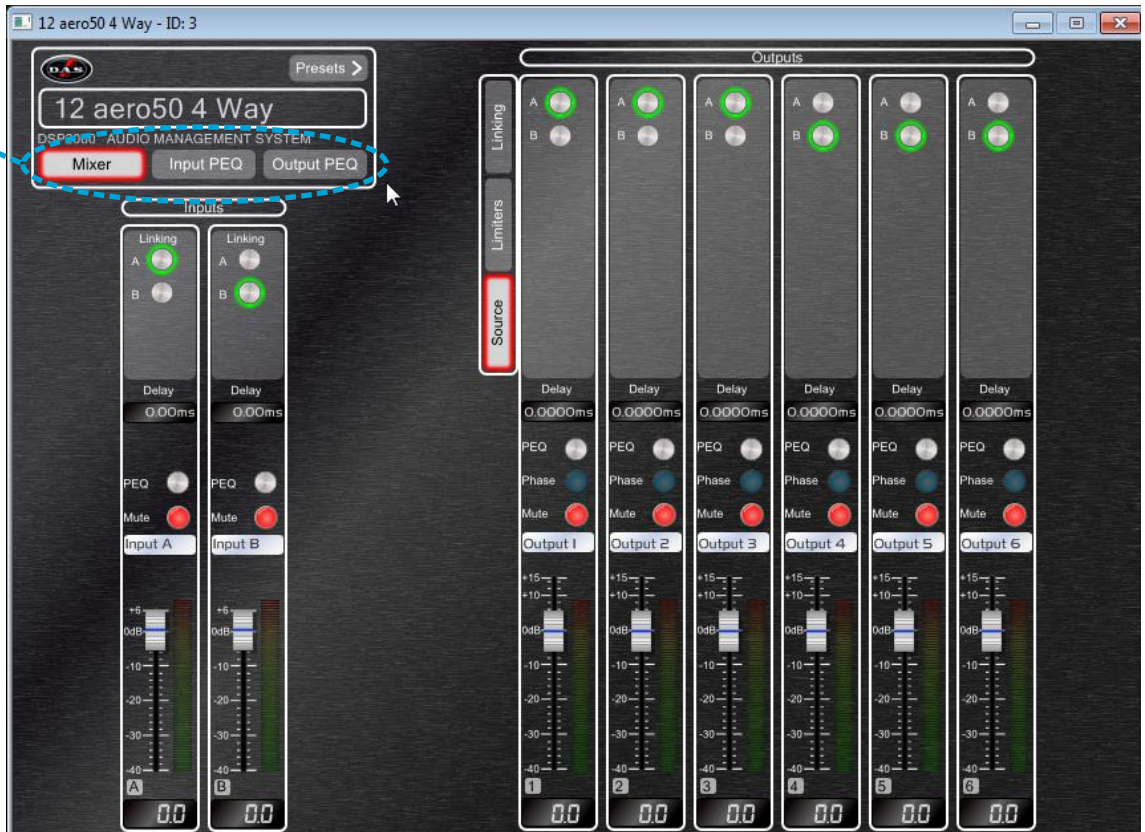

**10.1** On the **Mixer** menu three options are available: *Source*, *limiters* and *Linking*. *Source* is the input matrix and can be used for routing inputs and outputs.

In this case output 1 of the processor uses inputs A and B, outputs 2&3 use input A and outputs 4&5&6 use input B.

Besides the input / output routing on the *Source* menu the user can invert the polarity of the output channel (*phase*). *Mute / Gain* per output is available as well.

The *delay* per output is also accessible from the *Source* menu.

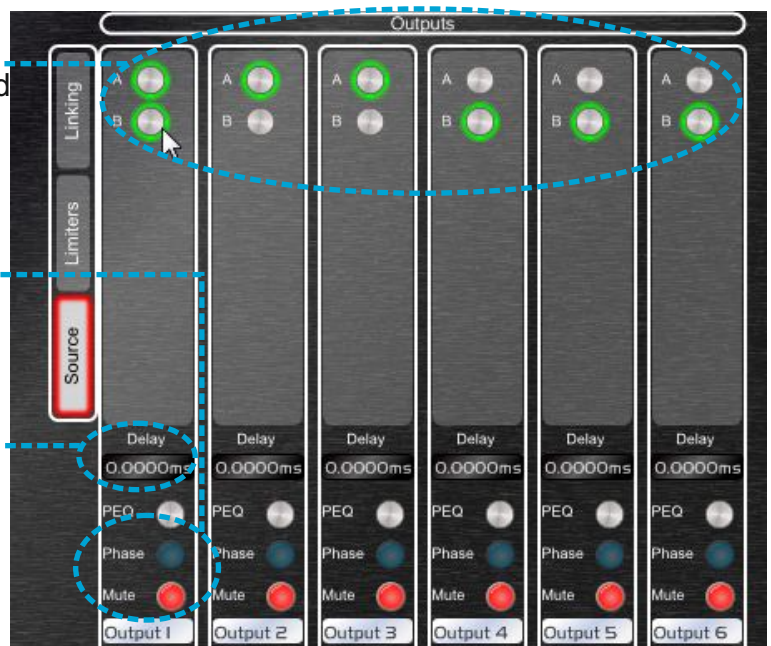



On the *Linking* menu the user can link channels. When two channels are linked all parameters are copied on both channels; gain, Eqs, delay, Xovers. Warning: polarity doesn't link between linked channels:

Output channels 1&2 are linked.  
Output channels 5&6 are linked.

Check that delay on channels 1 and 2 is the same.  
Phase is not the same on those two channels although they are linked.

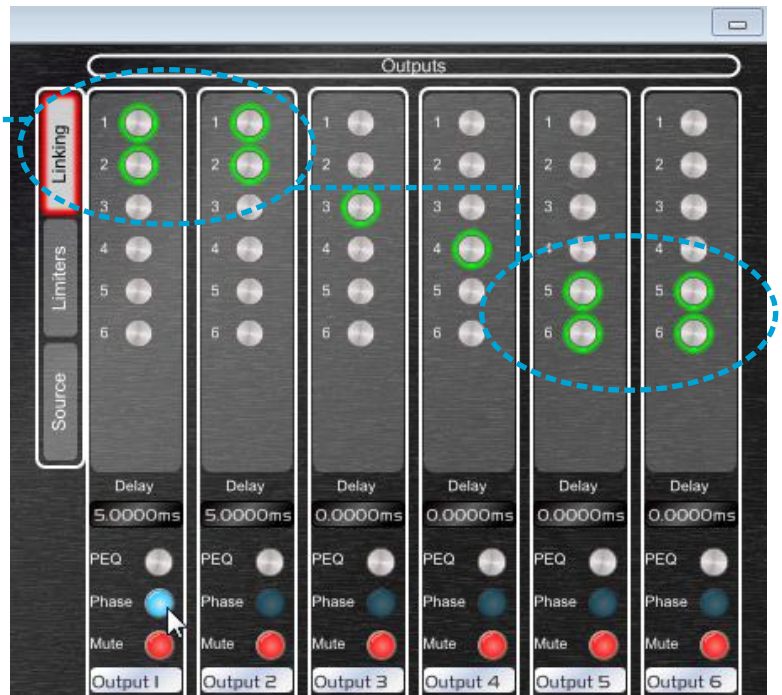

On the *Limiters* menu the user can set up the limiter threshold, attack and release time per output. There are two ways of working with the limiters, *automatic (auto ON)* mode which uses the Xover frequencies on each output to calculate the time constants. The user only sets the threshold. Or *manual (auto OFF)* mode; in this case the user defines the attack and release times.

Auto limiter on / off

Threshold (level)

Peak limiter (clip)



Threshold level will set up the RMS limiter value and Clip Level Above will set up the Peak limiter.

RMS value can be calculated with the following formula: (in dB)

$$\text{limiter threshold} = 20 \times \log(V_d / 0.775) - \text{Amp GAIN (dB)}$$

where  $V_d$  is the desired voltage for the load.

$$\text{Power (Watts)} = V_d^2 / Z$$

For example:

D.A.S. Audio LX-218C subwoofer. 2400W RMS, 4ohm cabinet (2x18")

D.A.S. Audio D-100 amplifier. Amp Gain 36dB.

Using the formula  $V_d = \sqrt{2400 \times 4} = 97.8 \text{ volts}$

**Limiter threshold =  $20 \log(97.8/0.775) - 36 = +6 \text{ dB}$**

The time constants are set by the high pass filter frequency for that channel on automatic mode:

High Pass Filter	Auto Attack Time	Release Time
< 10Hz – 31Hz	45mS	x16 (720mS)
31Hz – 63Hz	16mS	x16 (256mS)
63Hz – 125Hz	8mS	x16 (128mS)
125Hz – 250Hz	4mS	x16 (64mS)
250Hz – 500Hz	2mS	x16 (32mS)
500Hz – 1kHz	1mS	x16 (16mS)
1kHz – 2kHz	0.5mS	x16 (8mS)
2kHz – 32kHz	0.3mS	x16 (4mS)

On the previous calculation for an LX-218C the limiter screen would be like this one (auto OFF):  
threshold + 6dB

attack time 45ms (related to 33Hz Lr24 used to process the cabinet)

release time 45ms x 16

Peak limiter +3dB (referred to +6dB)



**10.2** On the **Input EQ** menu the user can select input A or B and set up up to 8 parametric EQs per input channel.

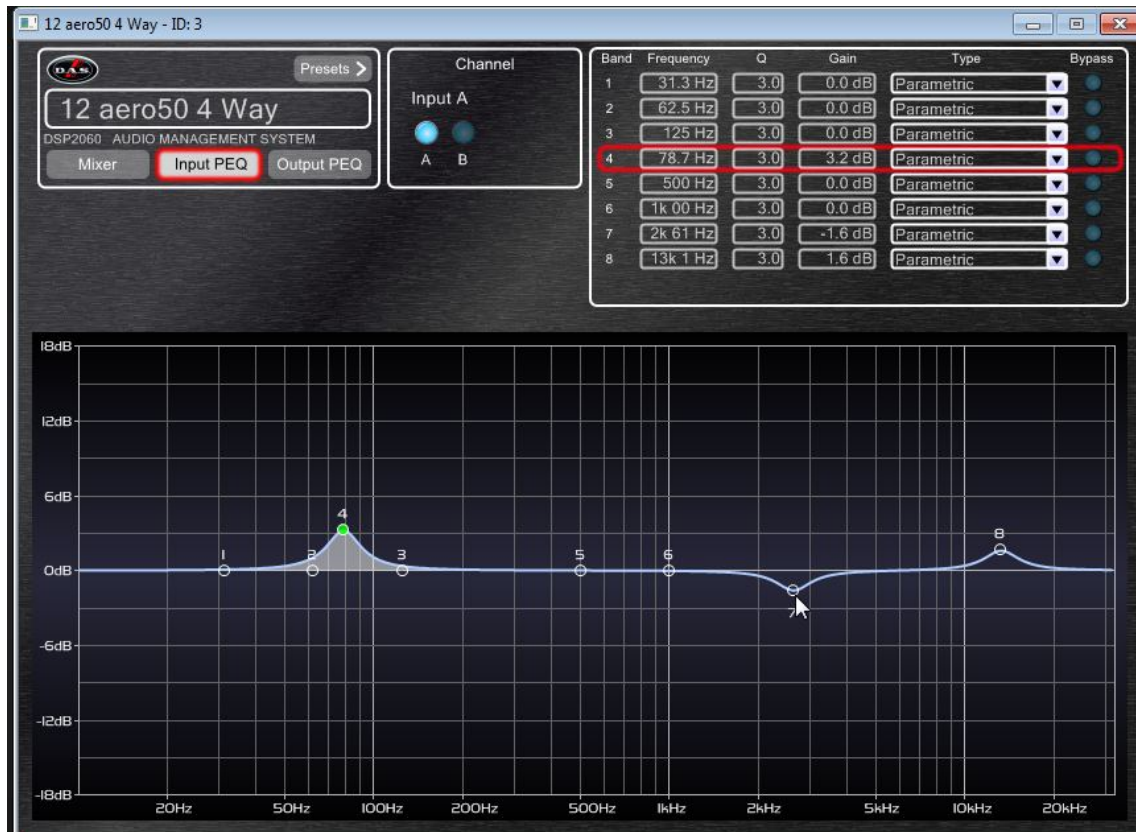

**10.3** On the **Output EQ** menu the user can select the output channel and set up up to 9 parametric EQs and Xovers per channel:





On the DSP window presets are available. New Store or recall can be done via DASnet:

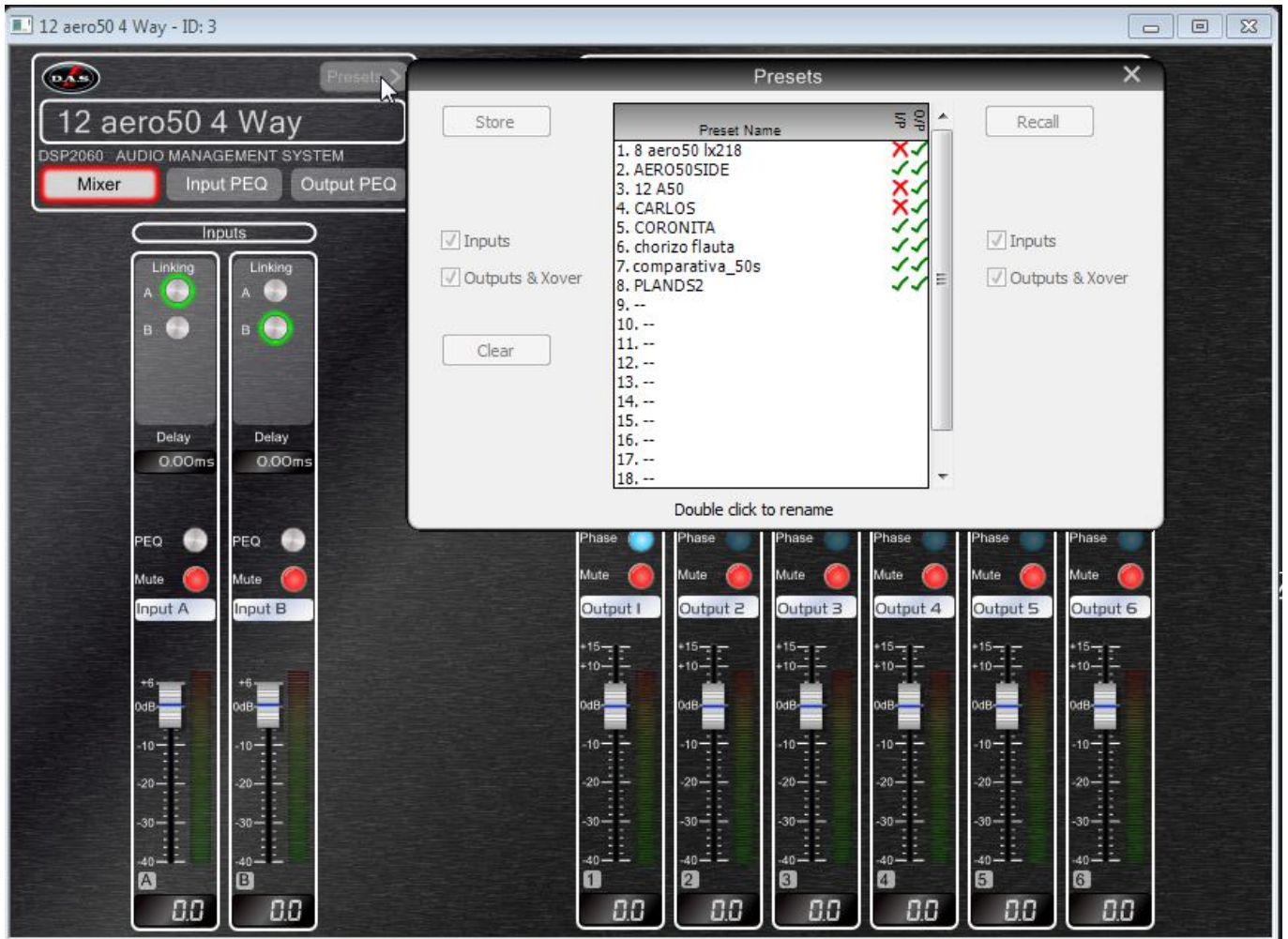

## 11. LINK MANAGER

Using this functionality parameters on different systems can be linked. The user can create Link groups (or parameters) and when varying a parameter in one cabinet the others will be affected as well.

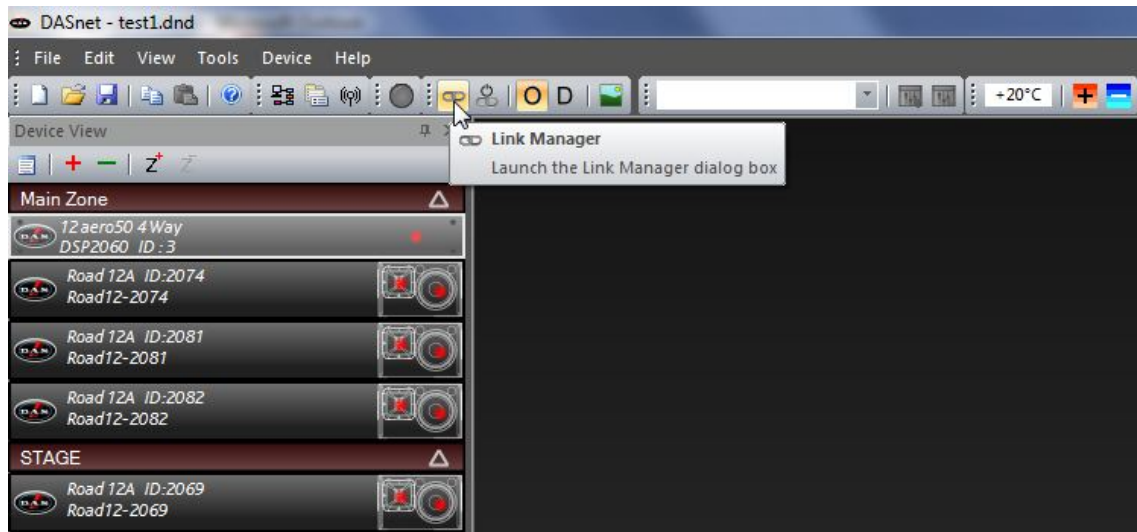

The link Manager opens a new screen where different links can be created.

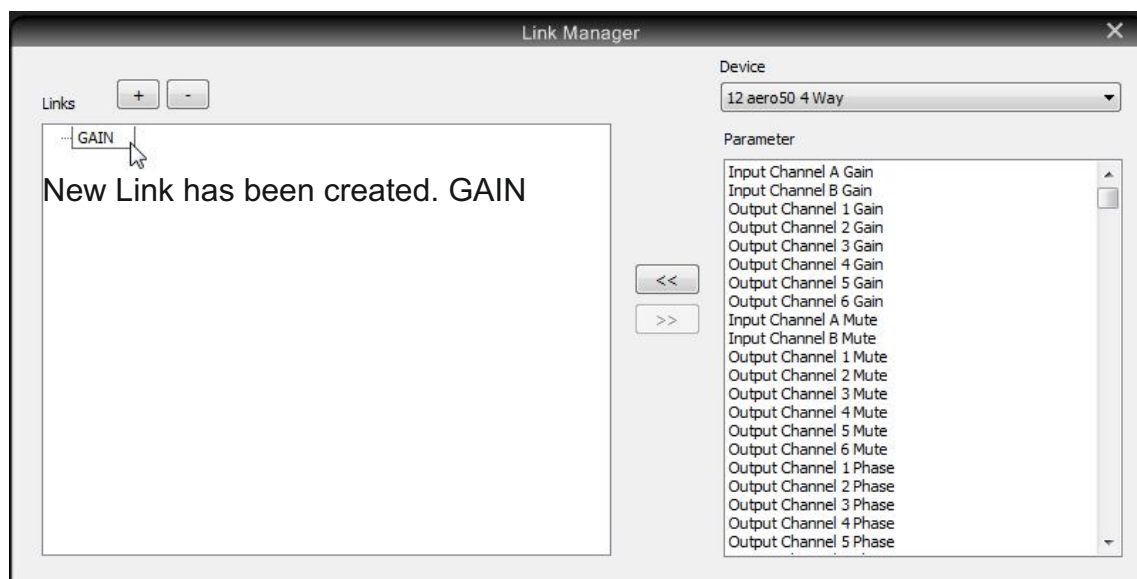
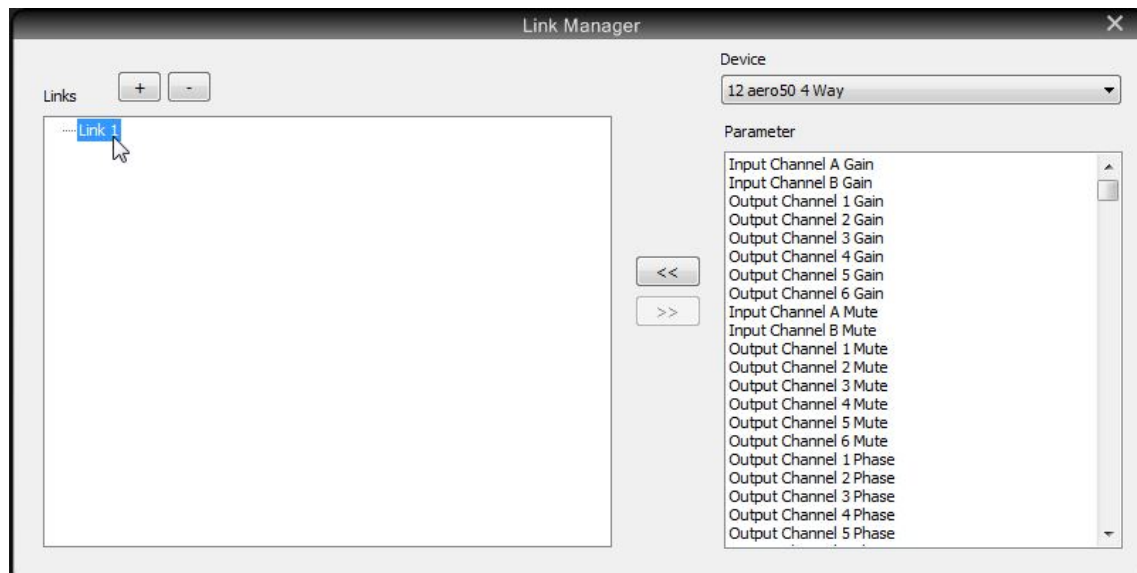

The devices on the net appear on the right part of the screen. From any device a list of parameters can be selected. In this case we have selected the GAIN of the Road 12 -2069

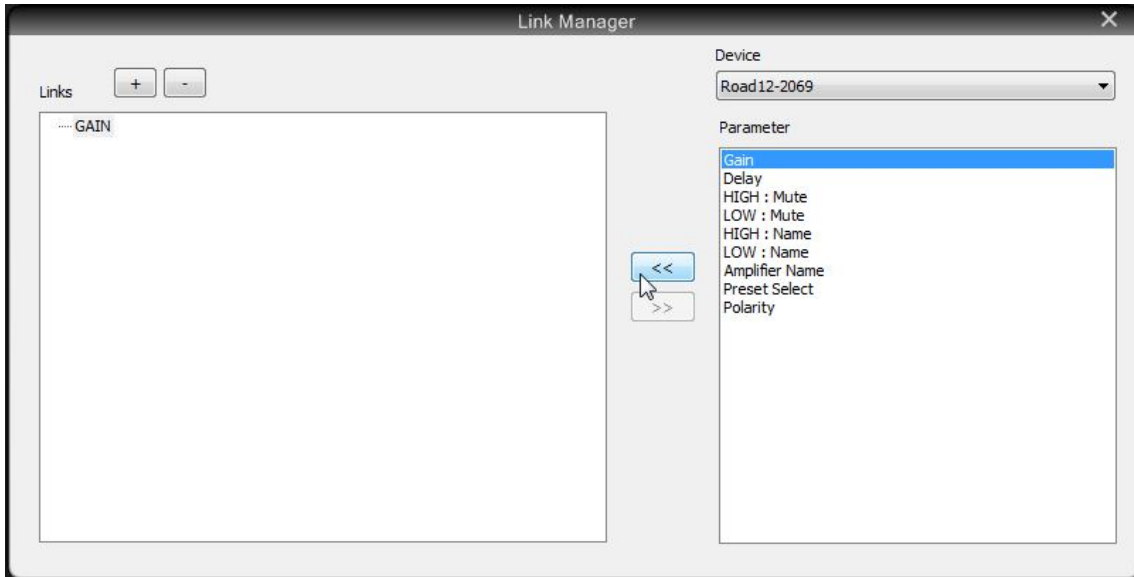

More cabinets (Road 12 - 2074) are selected:

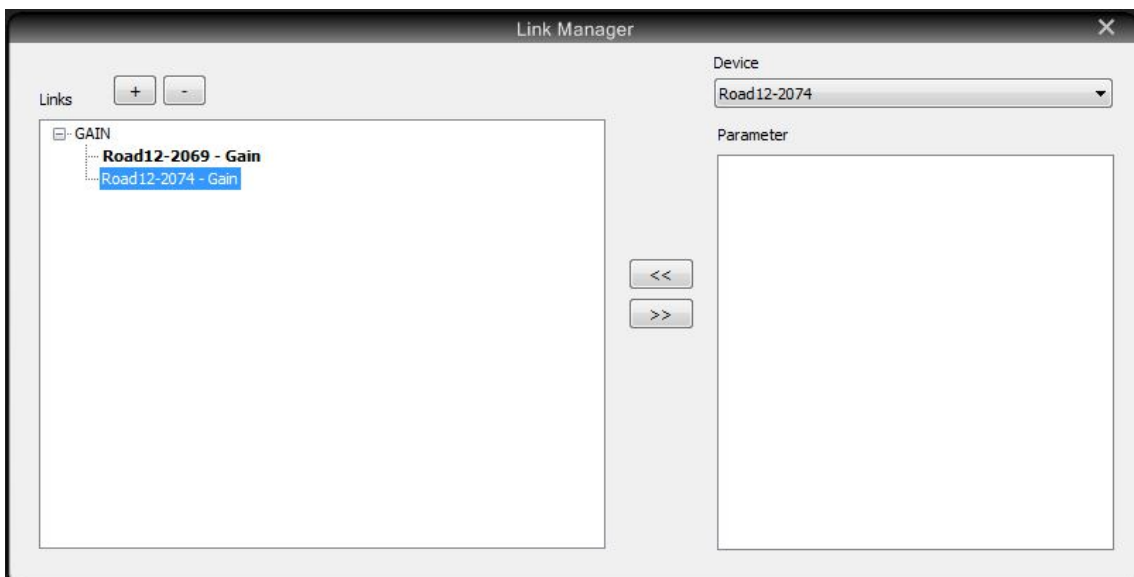
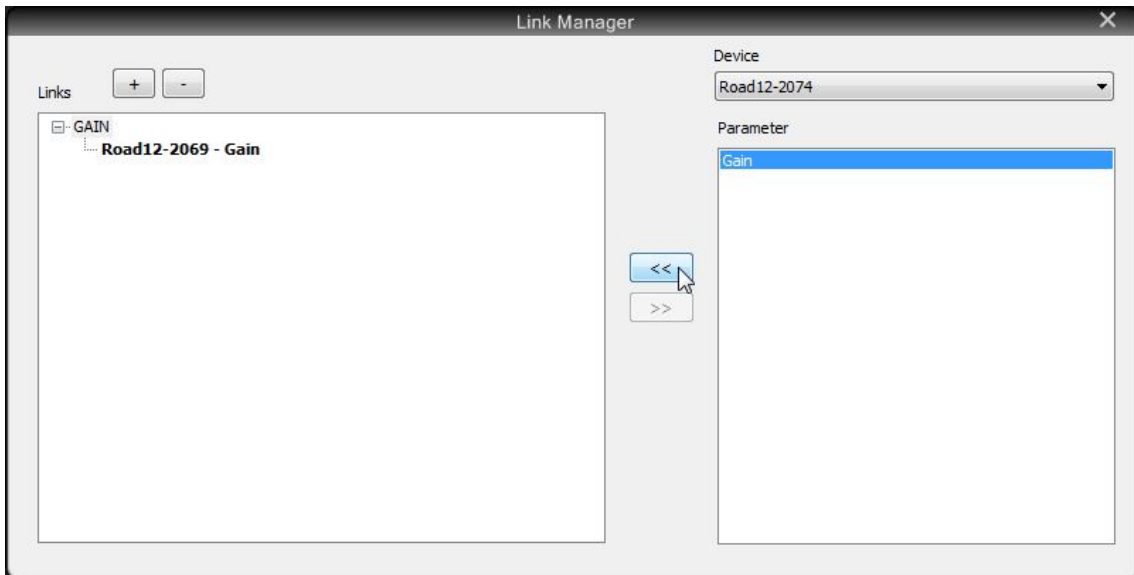

For now we have linked the system's gain of two cabinets: ID 2069 and ID 2074

In order to work with the link manager the user has to activate it. Linking Status ON:

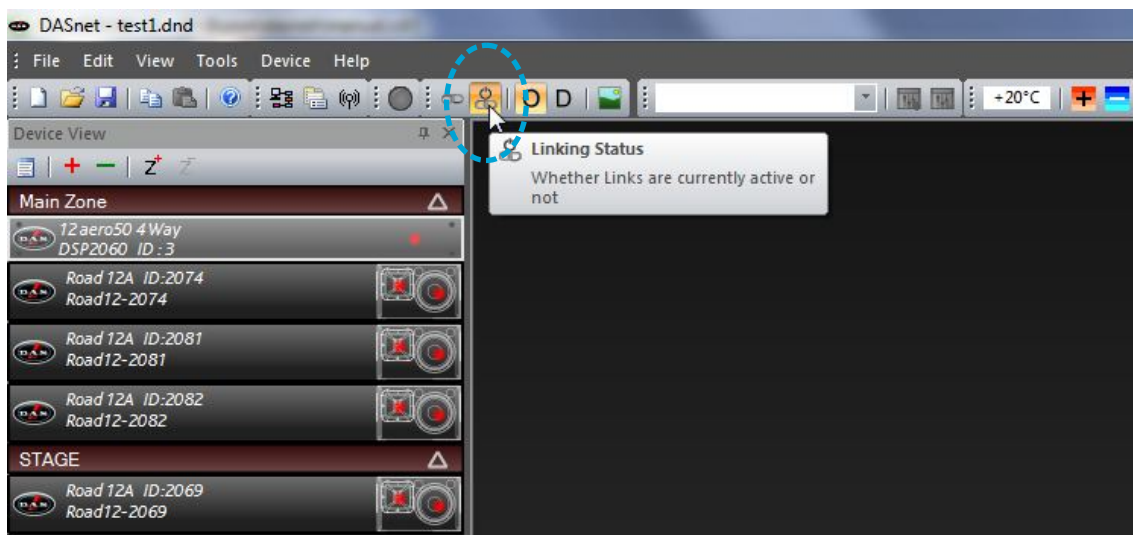

We have linked the gain of two of the stage monitors. If we vary the gain of one of them, the other's gain will automatically change:



With the link manager Gain/delay/mute/amplifier name/preset/polarity can be linked on the cabinets.

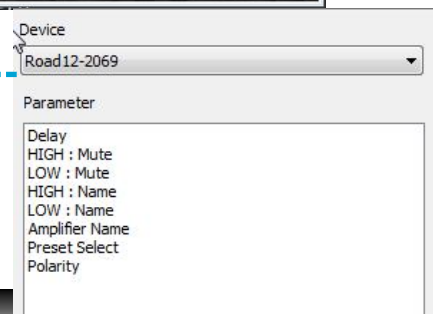

We are creating a new group for those 2 monitors. Preset:

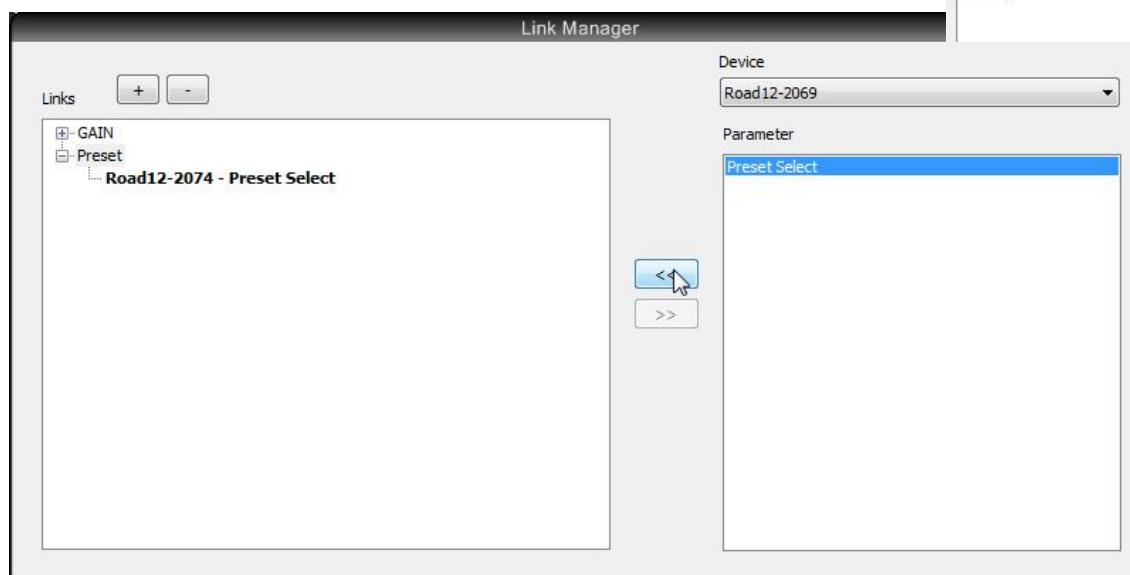



Now besides the system's gain the preset is linked on both cabinets:



**Important**

Example:

When working with aero 40A systems the **link manager** will be very useful to adjust the system's settings. In this particular case the user should create a link with the parameter **number of units**. Then will be very simple just by changing on one of the cabinets the *number of units* parameter to adjust the desired value.

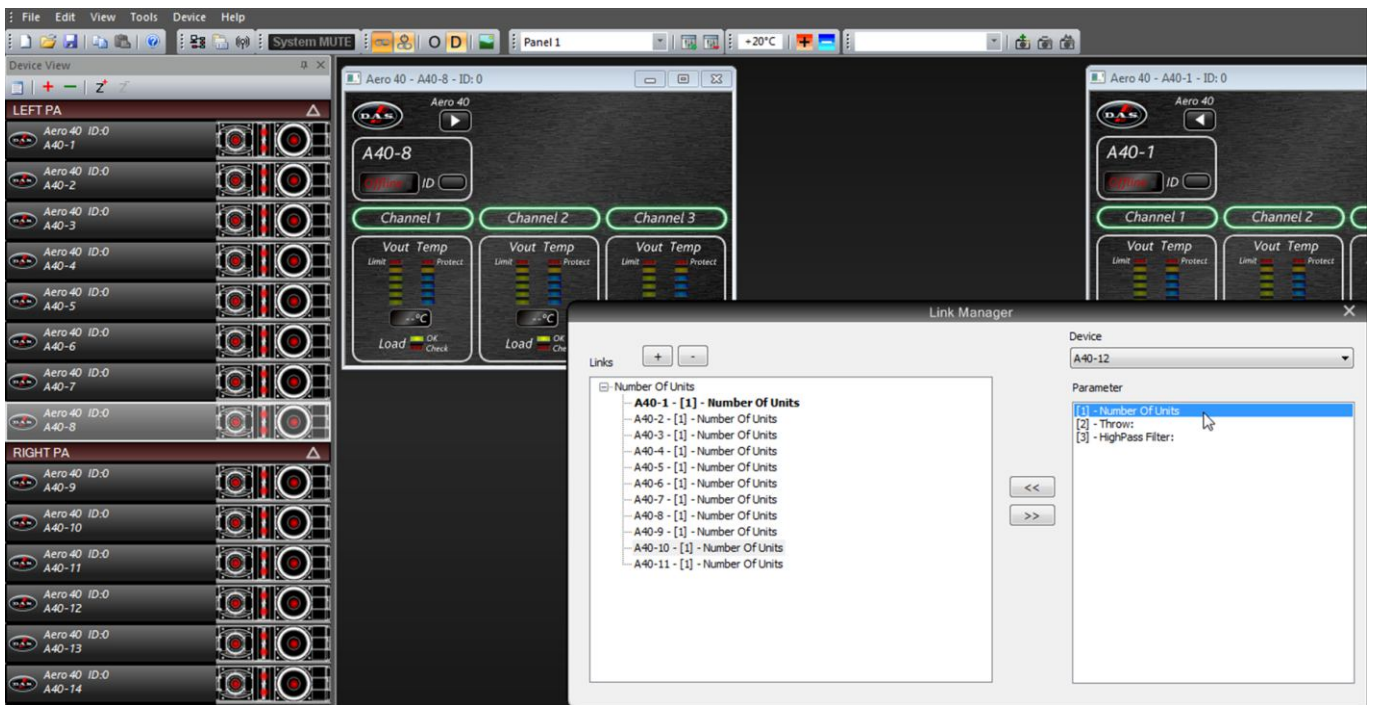

## Link Manager Creating groups on software versions later than 1.1.0

With the integration of the aero 20A in the software, new improved and added features are also available. One of the most significant ones refers to the procedure of creating groups of parameters or linking parameters. Creating links of parameters can be done as described in section 11 or following this new procedure:

In the device view tree on the left a device multi-selection can be done by clicking *Ctrl + left mouse click* or with *Shift+left mouse click*.

In this example two aero 20A are selected by using left click + Shift.

With the devices selected press right click on the mouse and the following menu appears on the screen:

A new option is now available: *link manager*

Inside the Link Manager menu different parameter options are displayed. This menu and the options will vary depending on the system selected. For the aero 20A the options displayed are, Mute per amplifier Channel, *Number of units* and *Throw*.

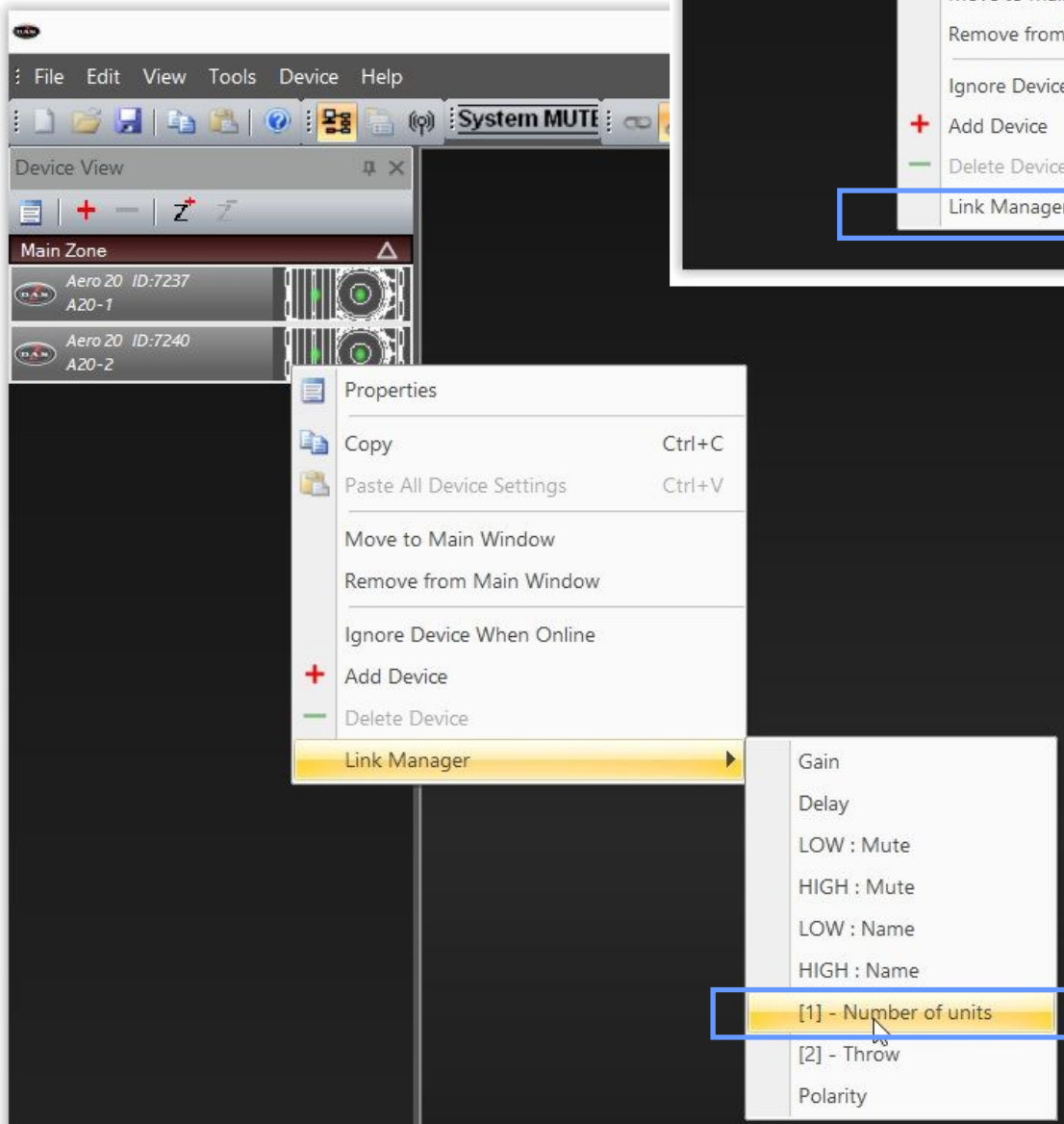
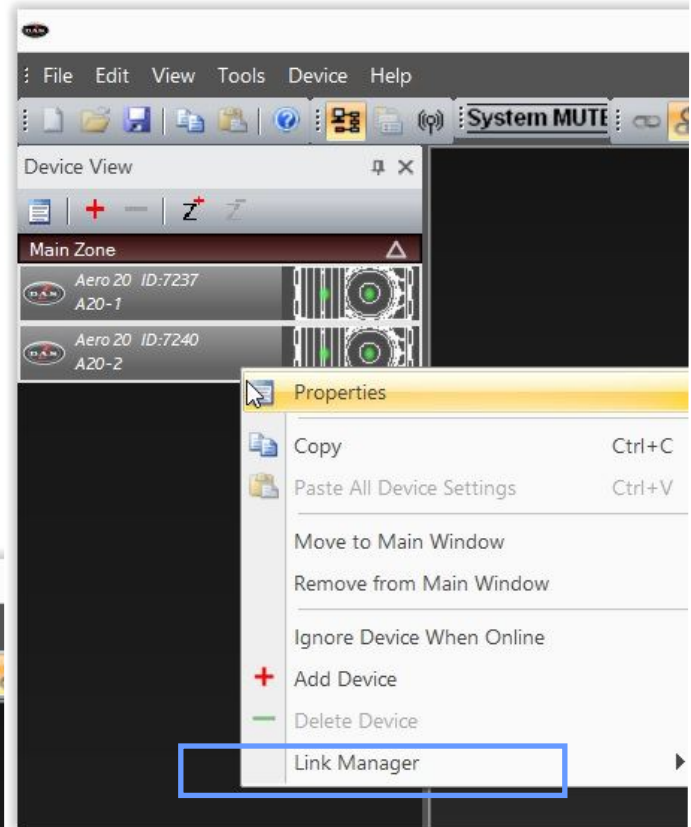

Once the parameter *Number of units* has been selected, a new link is created. By default the link's name shown is Link 1. Name can be defined by the user. In this case we use Number of units. With this procedure a link has been created in all the selected devices in a faster way than described in section 11.

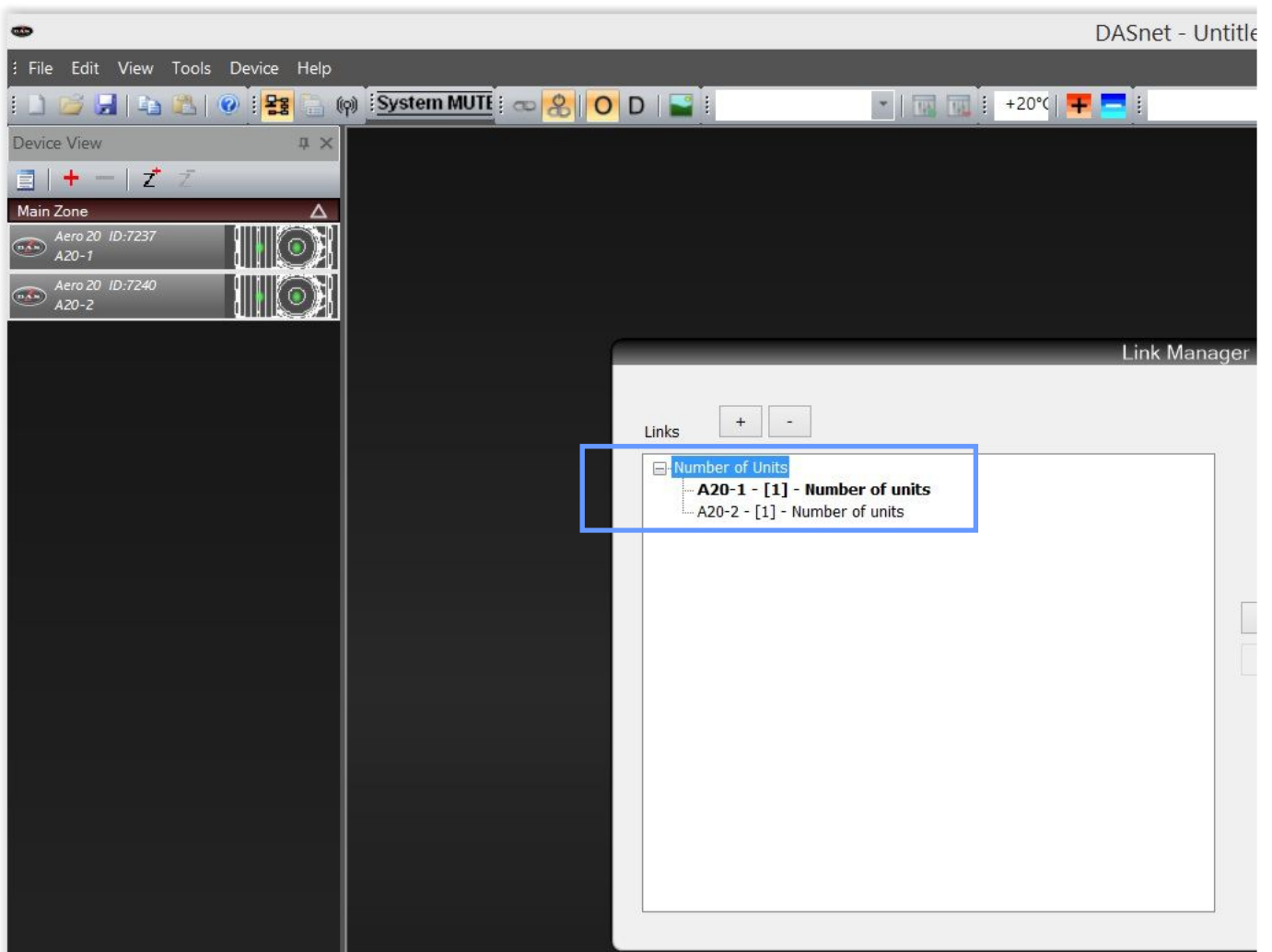

## 12. CUSTOM PANELS

With DASnet on *Designer Mode* the user can create *Custom Panels* which could contain *faders*, *knobs*, *buttons* to be associated to different system parameters. The utility of this tool is that if the *link manager* is activated, the user can modify parameters on more than one system at once with just a simple control. In this case Link Manager is activated and remember that all the cabinet gains are linked:

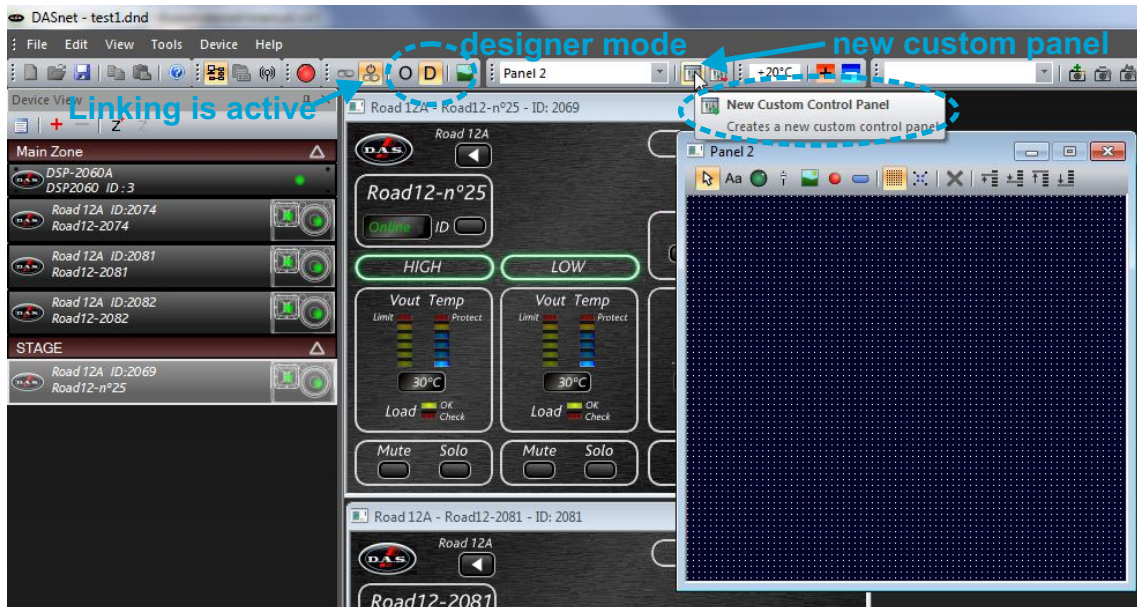

We are going to add a fader control:





Once the fader has been added on its properties window an image can be associated to it. Besides an image a parameter can be associated.



fader parameter

We are going to assign Road 12-nº25 gain to the fader's parameter. Remember that besides this, all cabinets' gain have been linked previously.

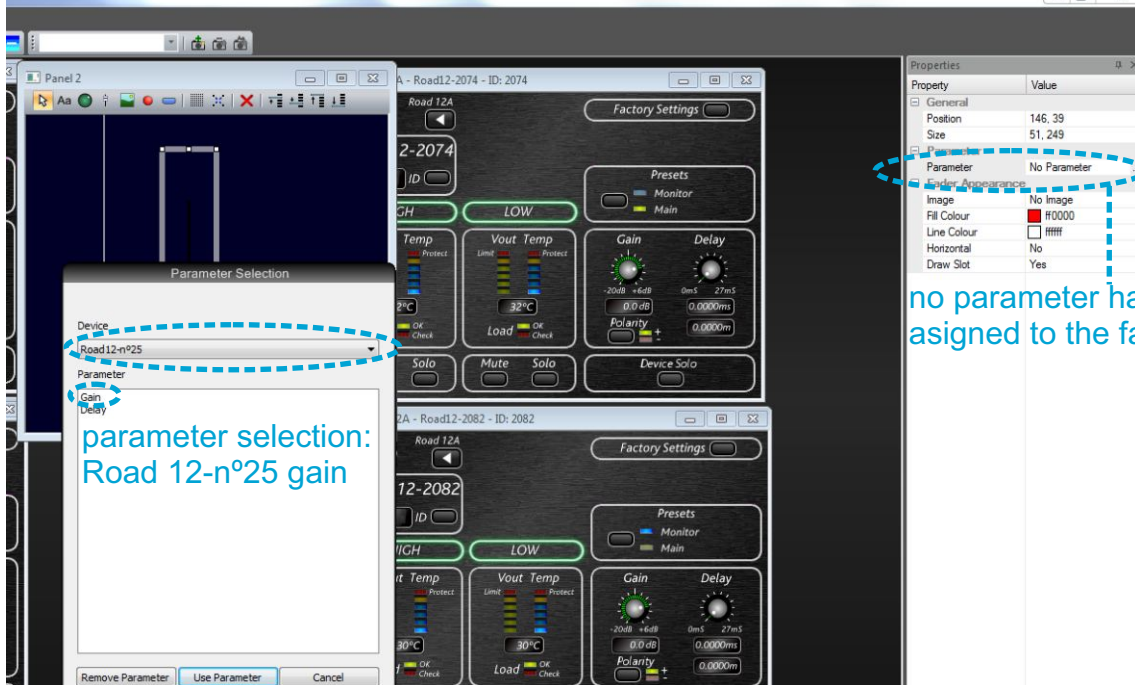

no parameter has been assigned to the fader

Now the fader is controlling the Road 12 -nº25 gain. As the gain of all devices has been linked using the link manager (section 11), the fader acts as a general volume control of all of them. The scale of the fader can be drawn. User can change font and colour.



fader's parameter

scale parameters

An image can be associated to the fader control (*fader appearance*):

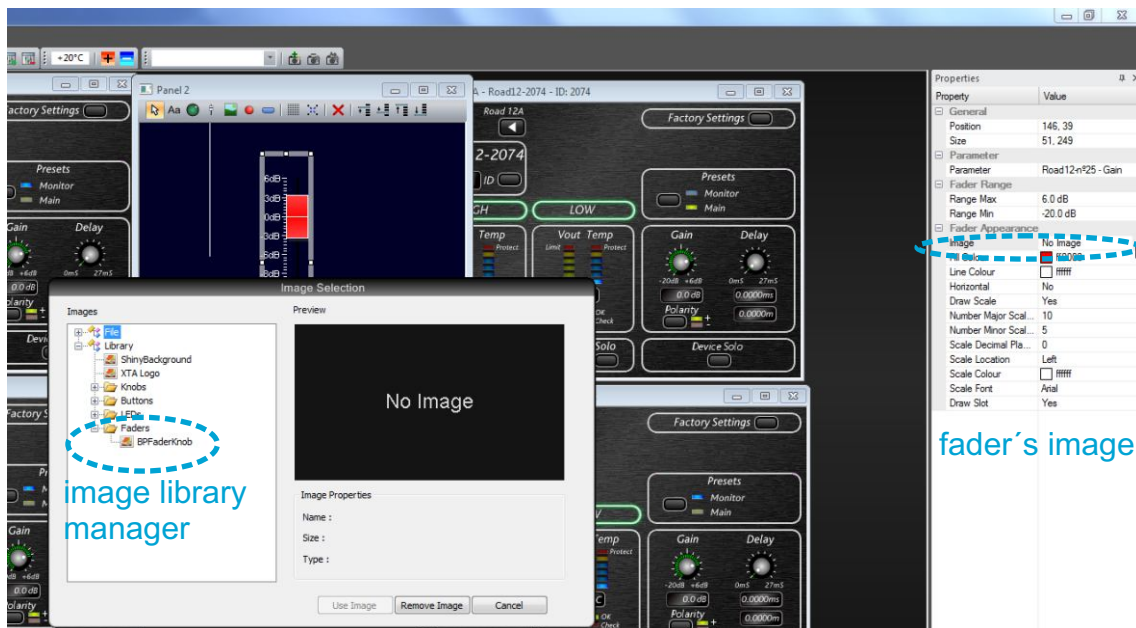
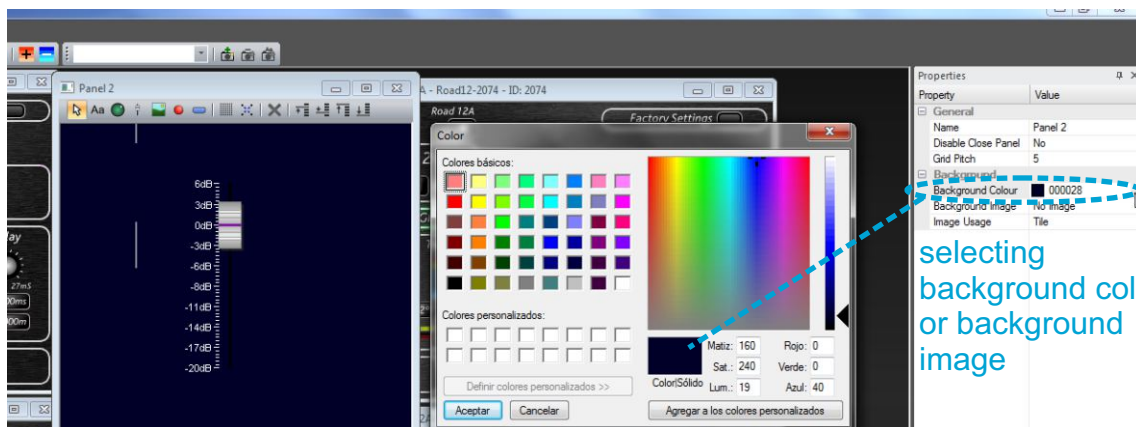

image library manager

fader's image

There is an image library where *buttons / leds / knobs / faders* are stored. The user can also import new images to the library (see page 37). The custom panel background colour can also be changed. An image can be set up as background as well:



selecting background colour or background image



Remember that to create a custom panel the user must be on *Designer mode*. Once the Custom panel has been created it will be saved with the \*.dnd file. To operate with it change to *Operator mode*.



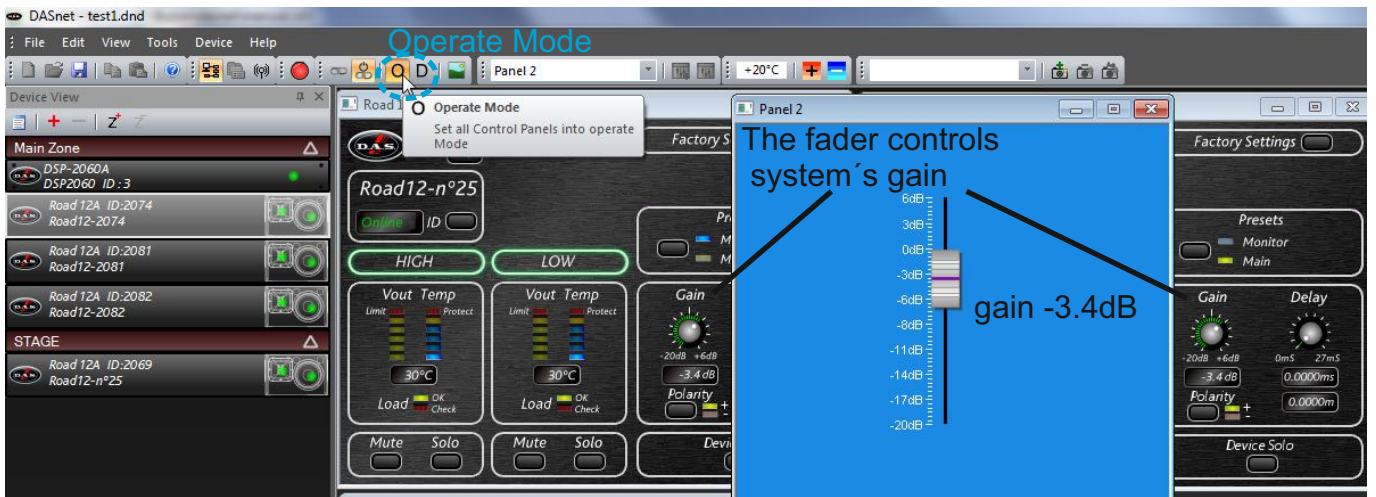

New background colour for the custom panel and operate mode. Check that fader control all cabinet's gain. (-3.4dB).

On a *Custom Panel* a *button* and a *led* to control the mute operation . If we come back to the Designer Mode we can add new controls to the panel: LED & BUTTON  
 come back to the Designer Mode we can add new controls to the panel: LED & BUTTON



LED Appearance: BIGyellowLED selected as LED image:

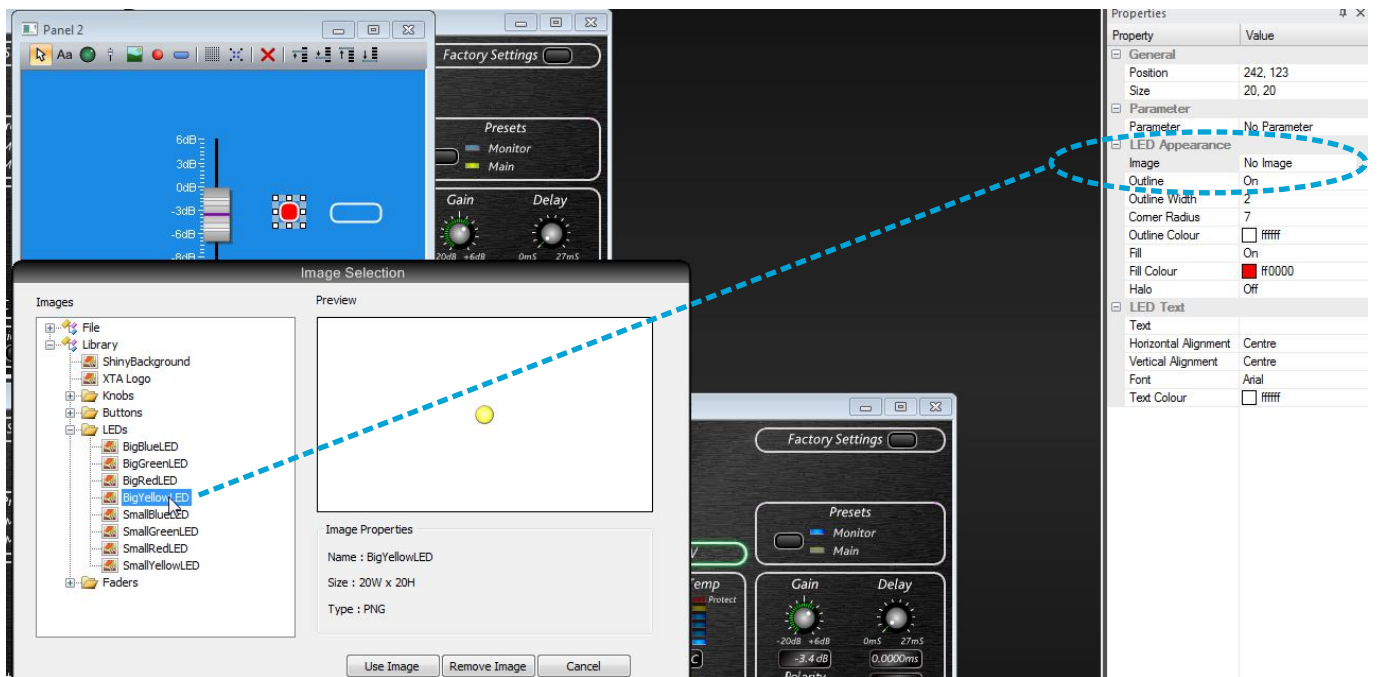

Button Appearance: BIGshinyButton selected as button image:

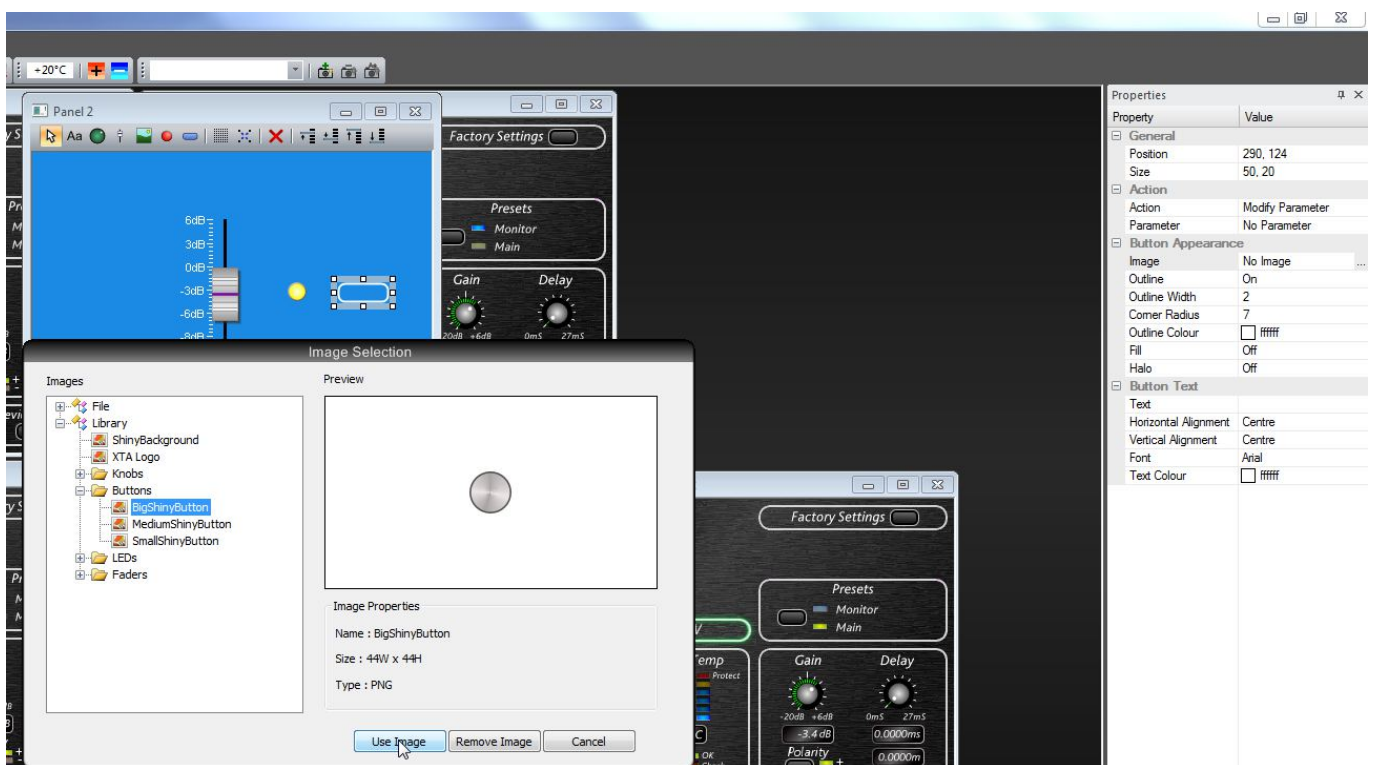



Road 12-nº25 HIGH Channel mute assigned to the LED as parameter:

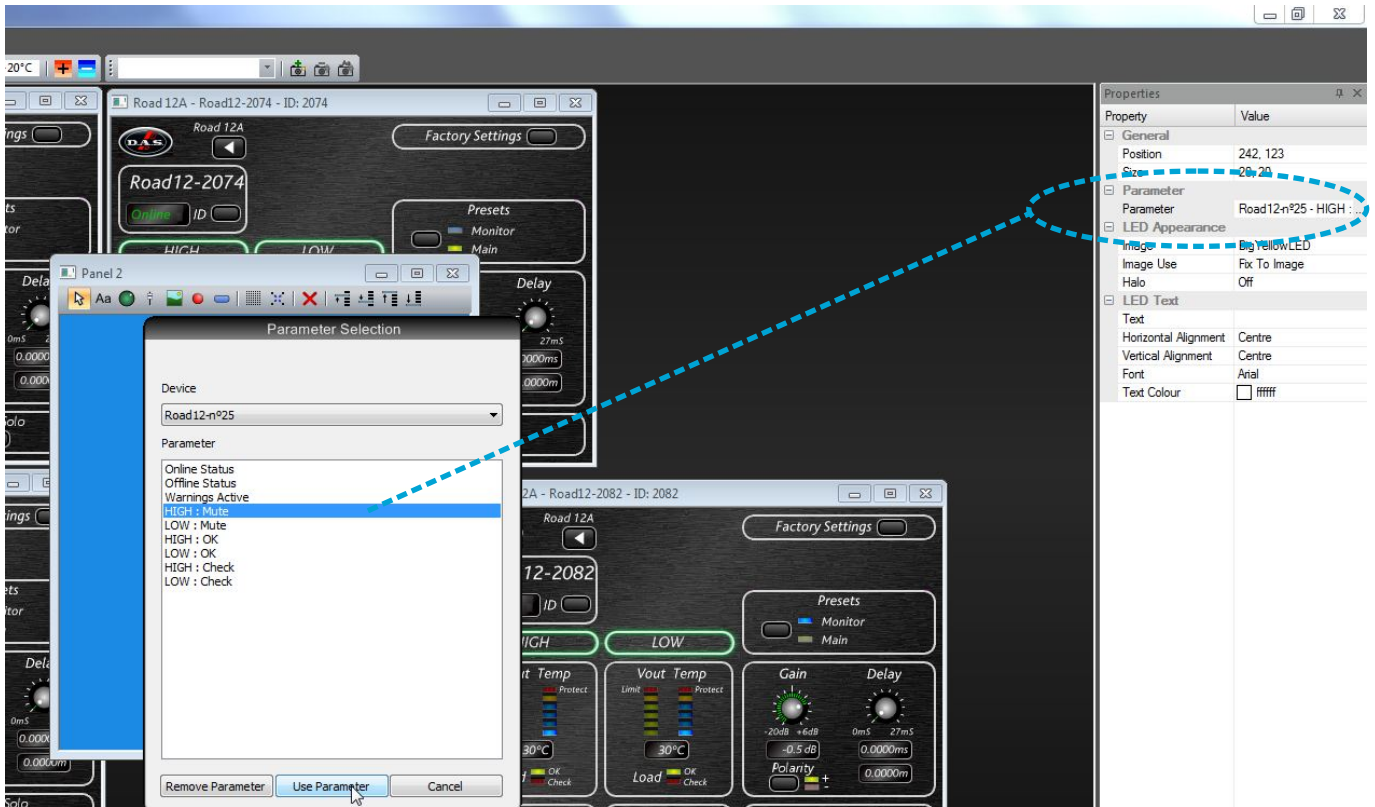

Road 12-nº25 HIGH Channel mute assigned to the Button as parameter:

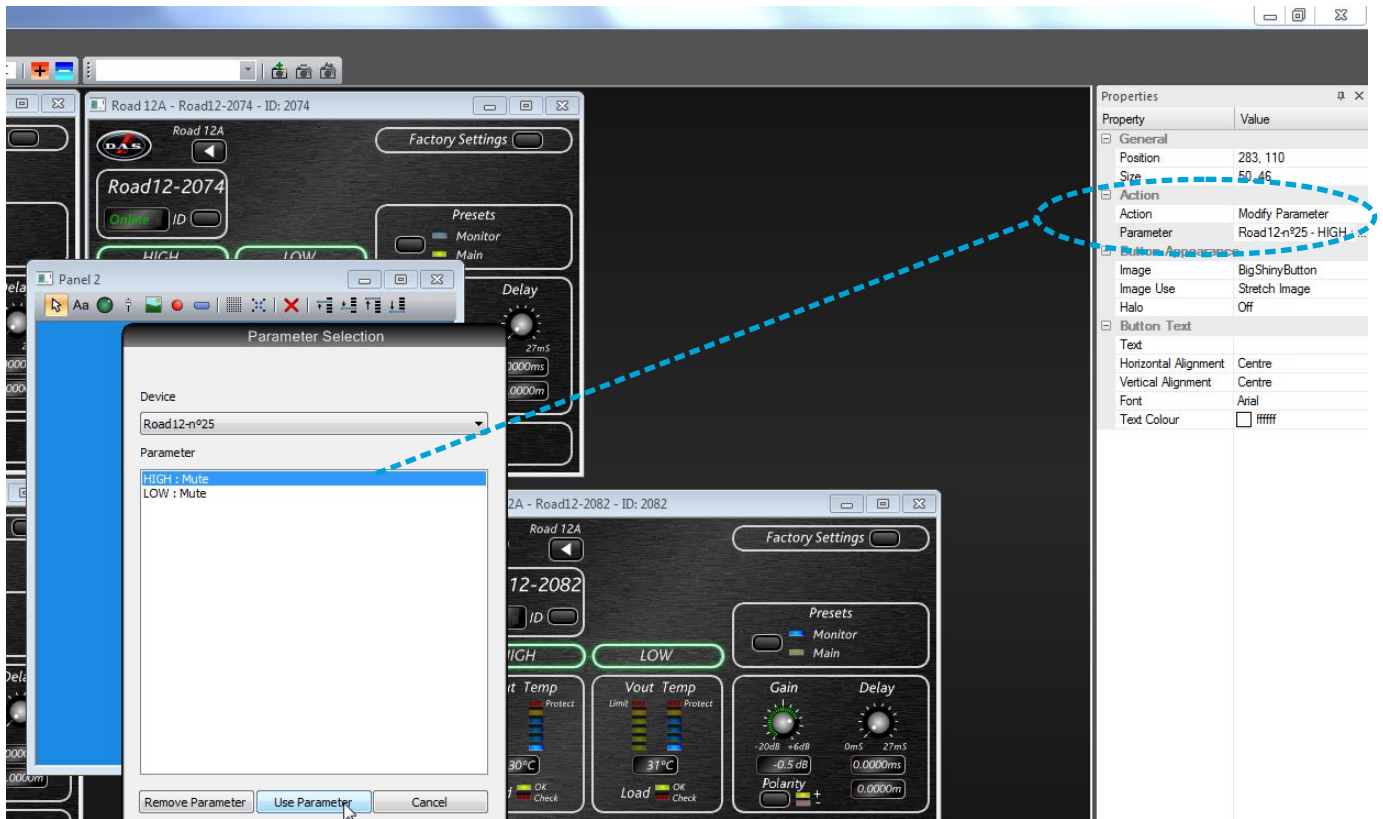

The Custom panel can include text and images from the image library manager. In this case the GAIN fader controls all the system and the mute buttons and leds both channels of the Road 12-n<sup>o</sup>25: (shown mute active on high channel)



The Custom panel can be as sophisticated as the user may want. Here is another example of a complete system and a custom panel with gain controls and mutes per amplifier channel.

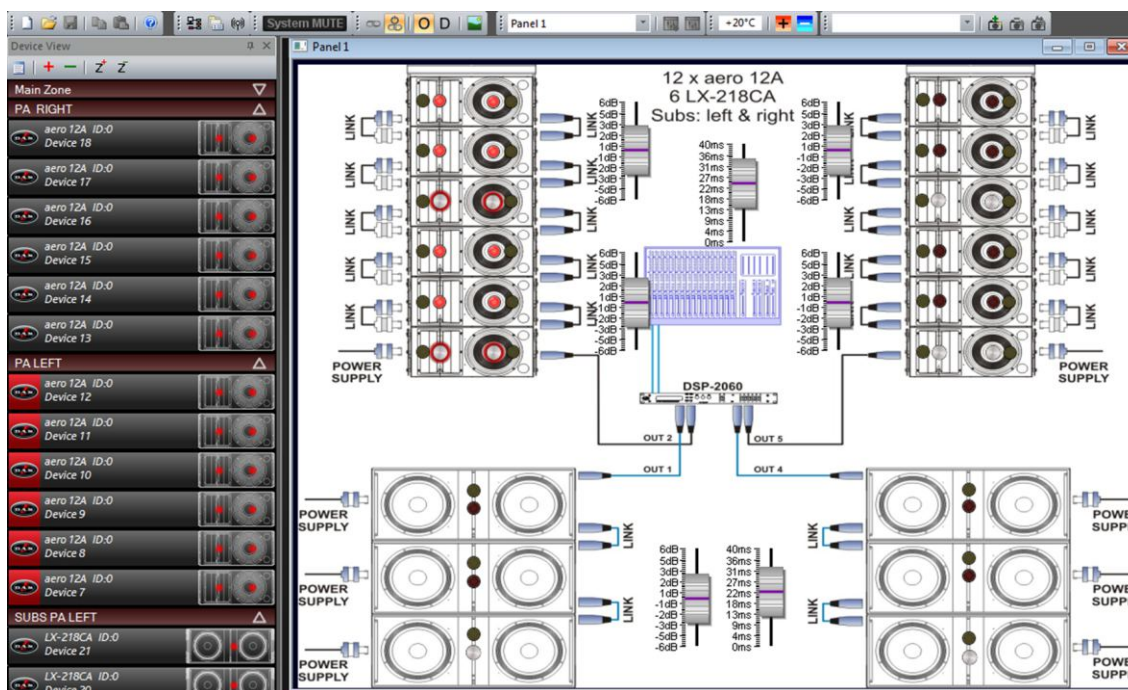

### 13. IMAGE LIBRARY MANAGER

DASnet includes an image library manager with predefined images. The user can create new folders and incorporate new images to the library. These images can be used on the custom panels or as a background.

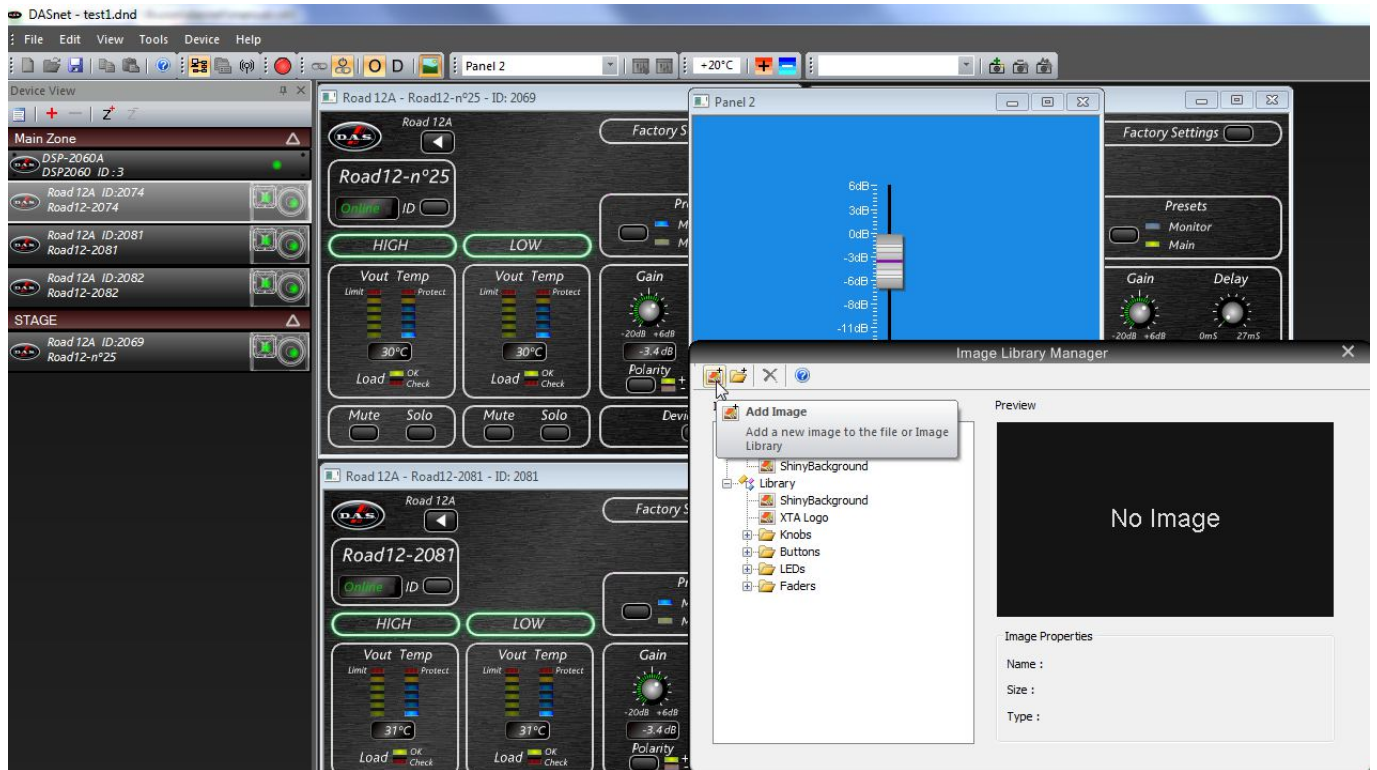



## Appendix 1. Quick aero40A system configuration

When rigging for the first time the aero 40A, the most important thing is identifying the order in which the cabinets have been flown to re-order them on the software.

For instance, let's consider the DASnet identifying process for one side of the PA composed of 8 aero40A.

1 - We have taken notes and the order in which the cabinets have been flown is the following:

cabinet number 1 (top): DASnet ID 2864  
cabinet number 2: DASnet ID 2399  
cabinet number 3: DASnet ID 2115  
cabinet number 4: DASnet ID 2429  
cabinet number 5: DASnet ID 2874  
cabinet number 6: DASnet ID 2323  
cabinet number 7: DASnet ID 2626  
cabinet number 8: DASnet ID 2605

2 - Second step is to do an "autoscan" on DASnet. The software recognizes all the connected devices (in this case 8 aero40A). BUT they don't appear in the physical order in which they have been flown.

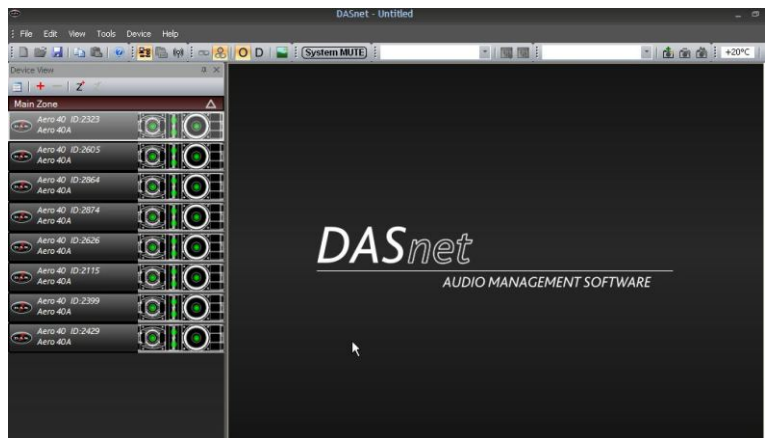

3 - Next step will be re-ordering and re-naming the cabinets accordingly to the physical order.

The cabinet 2864 is number one. The user has to locate it on the software, changing its name and moving it to the right position:



The aero 40A 2864 is aero 40A number one regarding the physical rigging order. We have to change its name and re locate it on the software.



Once cabinet aero 40A 2864 has been renamed to aero 40A-1 the user has to do the same with all the cabinets. Remember that the new name has to reflect the physical position of the cabinet in the cluster.

aero 40A 2323 is going to be aero 40A-6

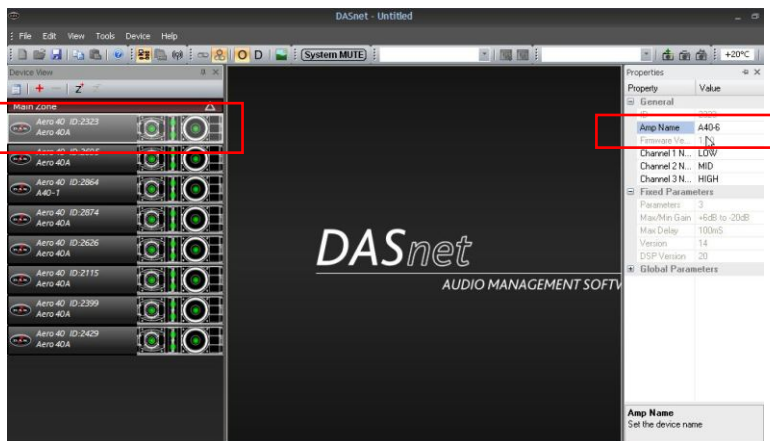

We have re named cabinets 1,6,5, 8 and continue with aero 40A 2626 which is number 7 in the array.



All cabinets have been re named:

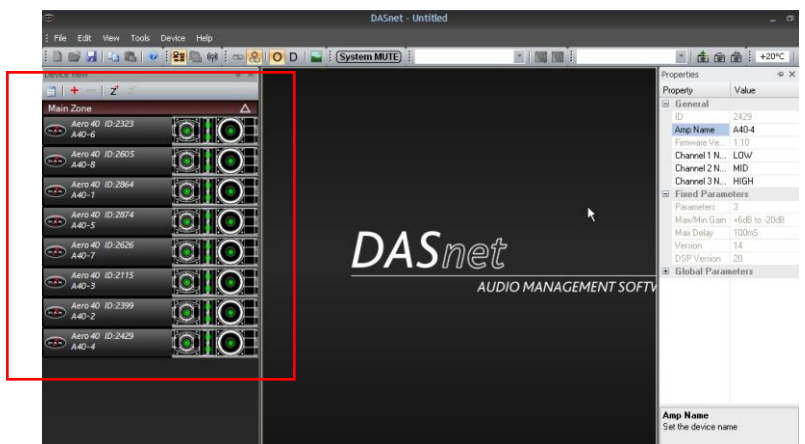

4 - Next step is to re-order the cabinets in the zone. Just click on the device view window on the desired cabinet, drag it to its correct position:

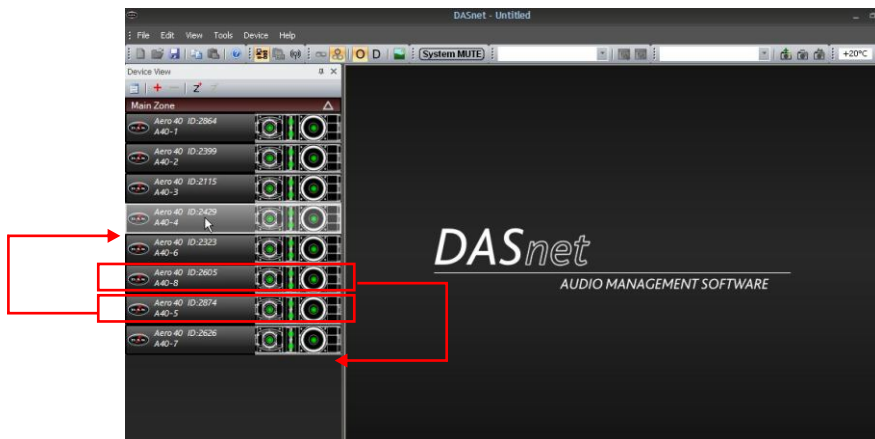

Now all cabinets have been re-ordered.

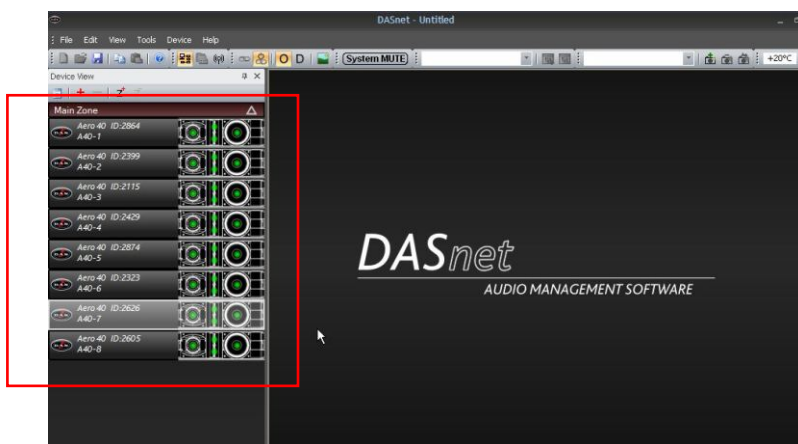

5 -Next Step on Link manager --> create new link --> number of units

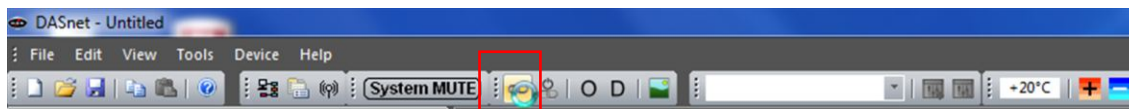

open link manager menu

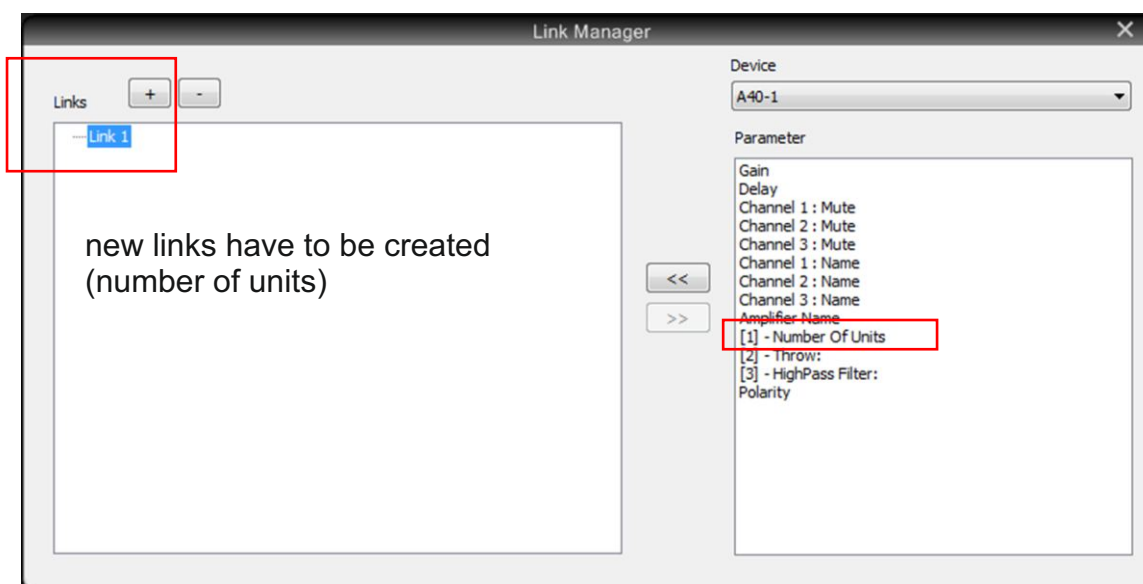

The user has to include in this new group all the aero 40A units. Doing this when a user changes the number of units preset in one cabinet it will affect all the others as well.

We have created a new link named **“number of units”**. Among all the possible parameters, select all the aero 40A (from 1 to 8) the parameter **number of units**.

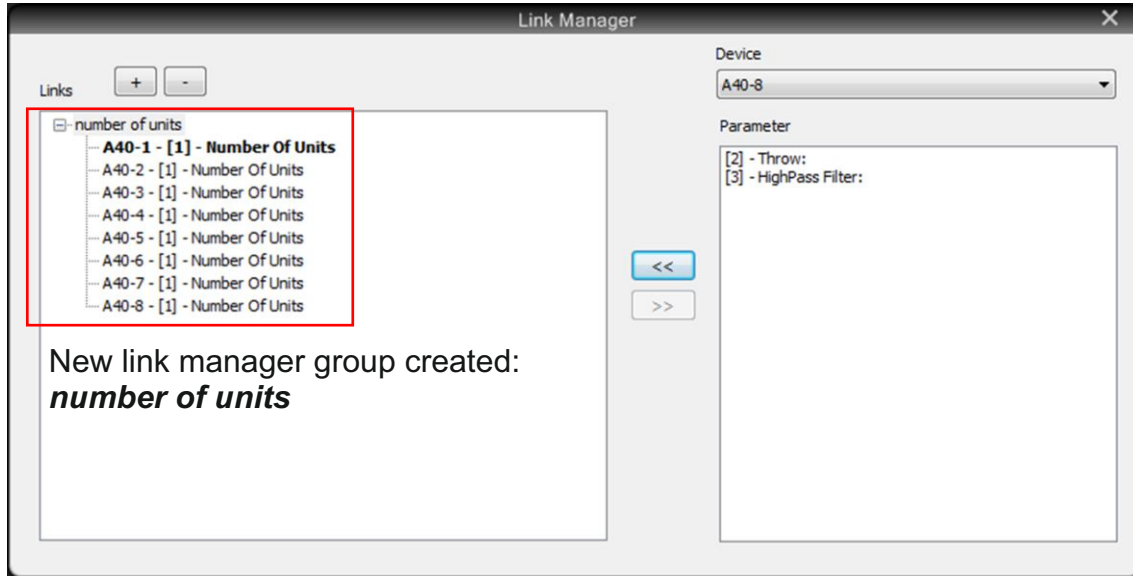
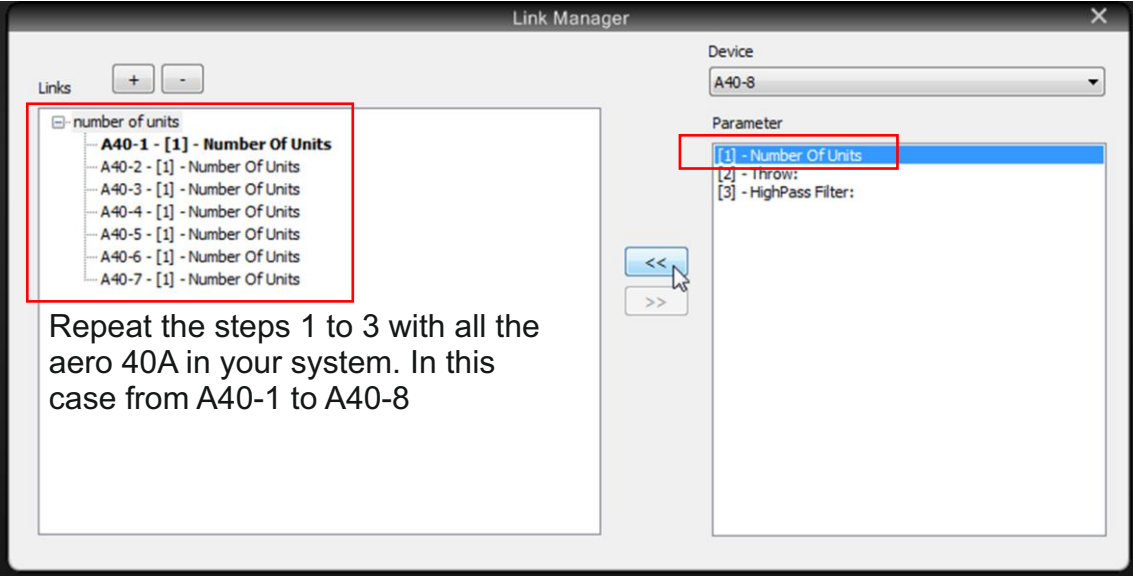
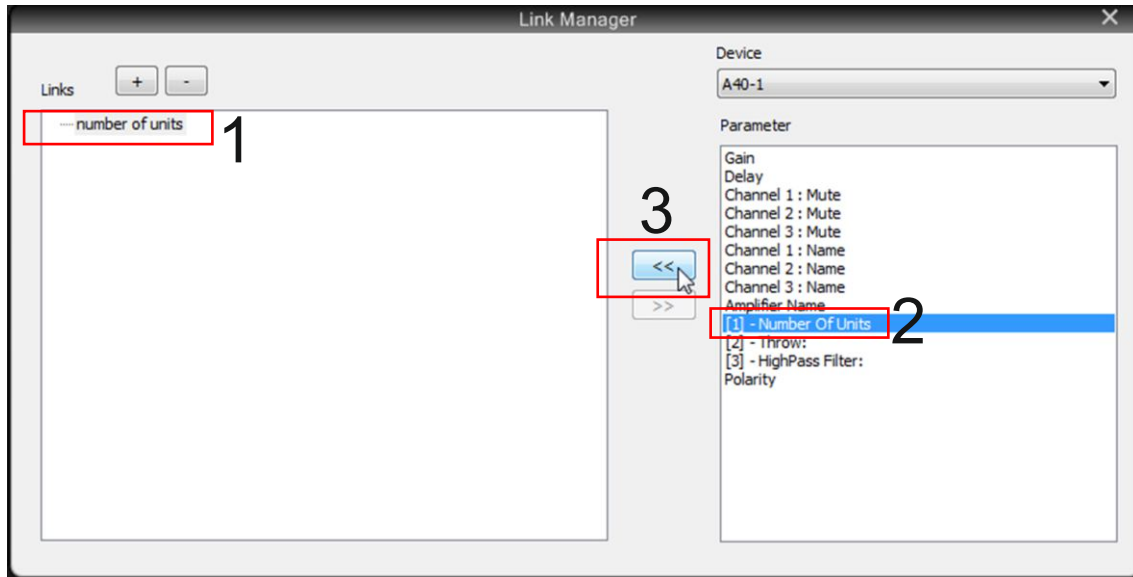

Activate this option on the software for to enable the link manager groups:

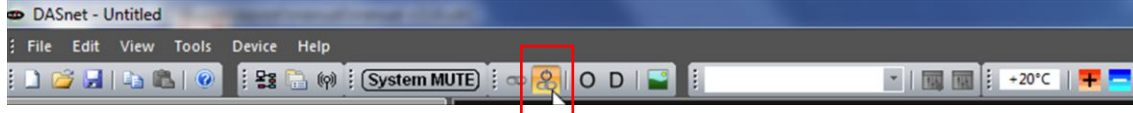

6 - Next step is to create a group with the parameter HighPass Filter using link manager:

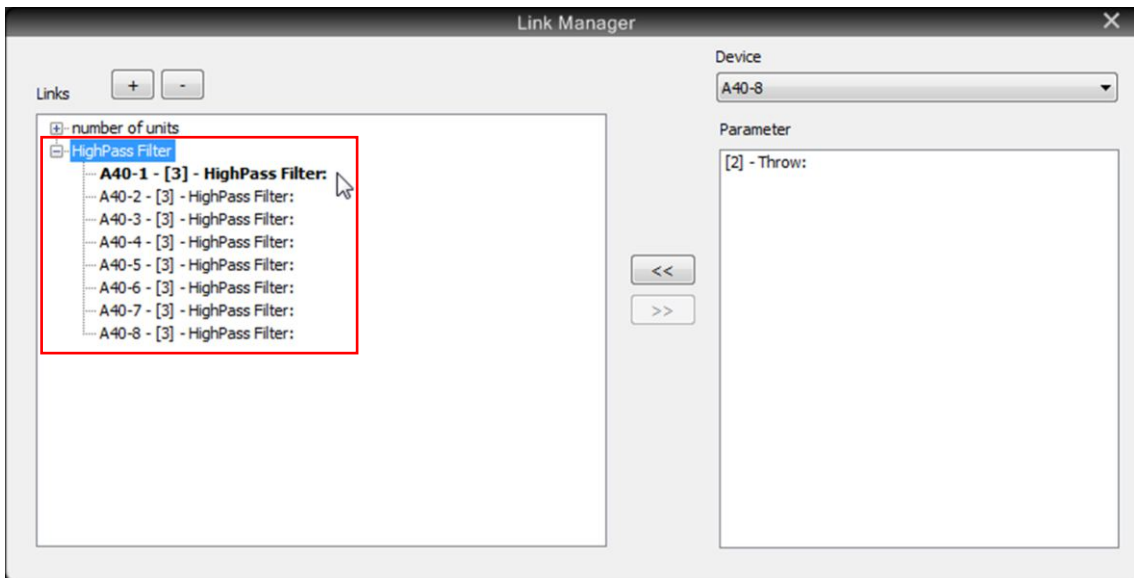
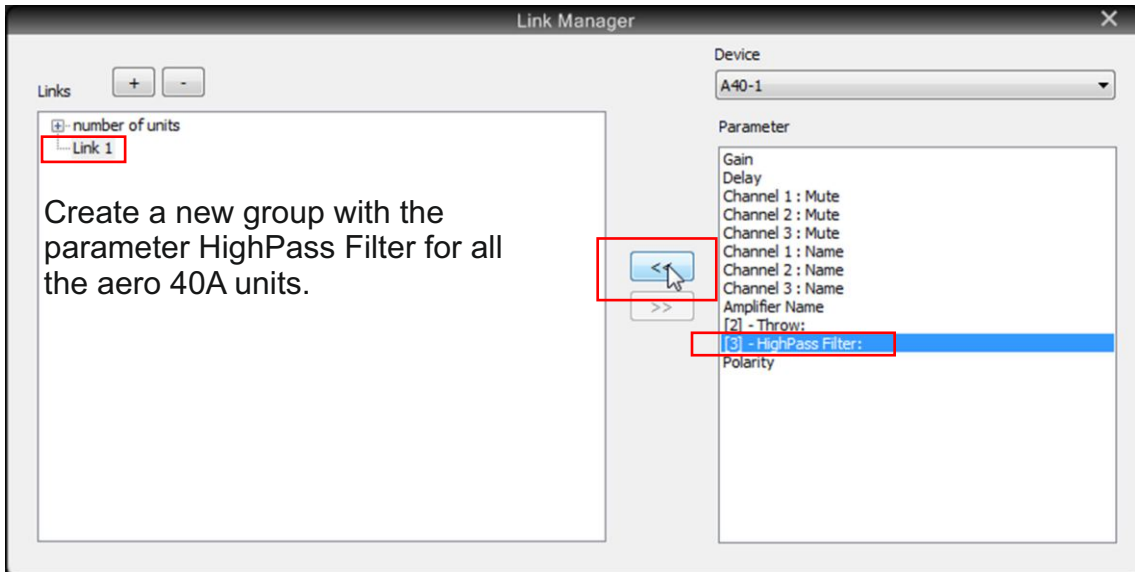

With these two links, **number of units** and **HighPass Filter** the user can start the tuning of the system.

NOTE: There are more parameters that could be linked as the **Throw** of the cabinets.



## Appendix 2. Move to Main Window

Multi-selection of devices is available on version 1.5 using Shift or Ctrl + left mouse click. When a unit (or more) has been selected on the Device View window by doing right click on the mouse the menu *Move to main window* is displayed.

This command allows to move the selected devices to the main screen.

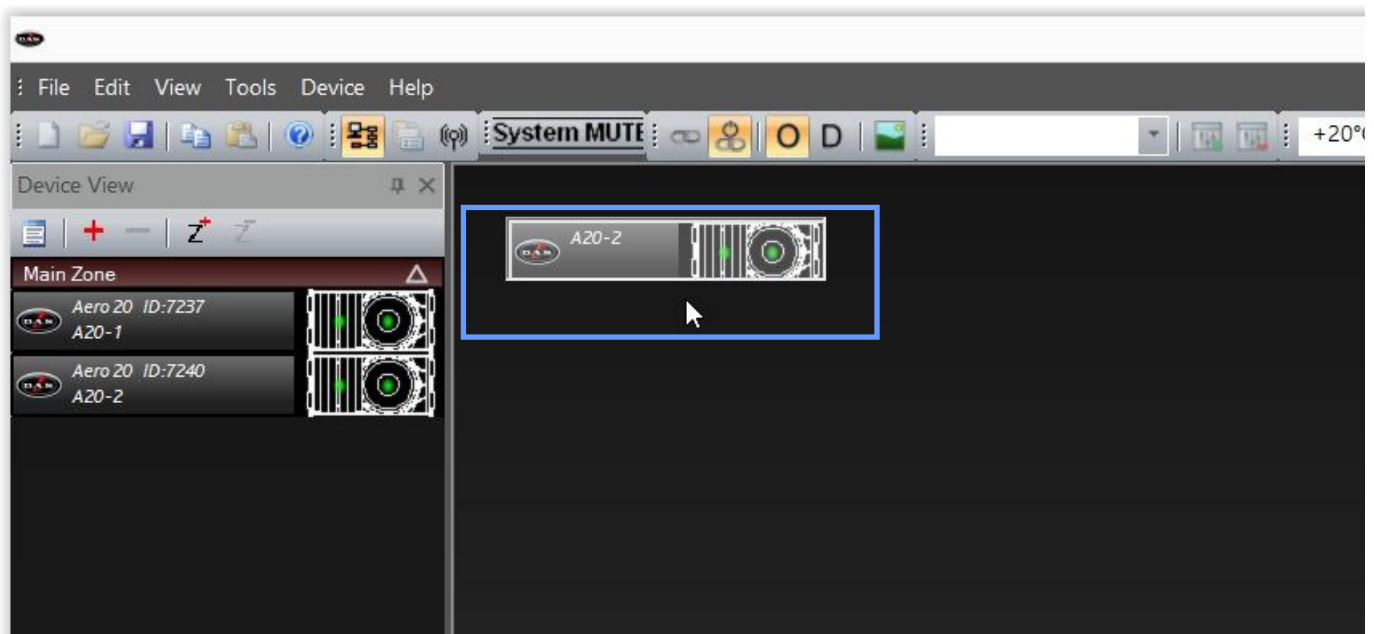
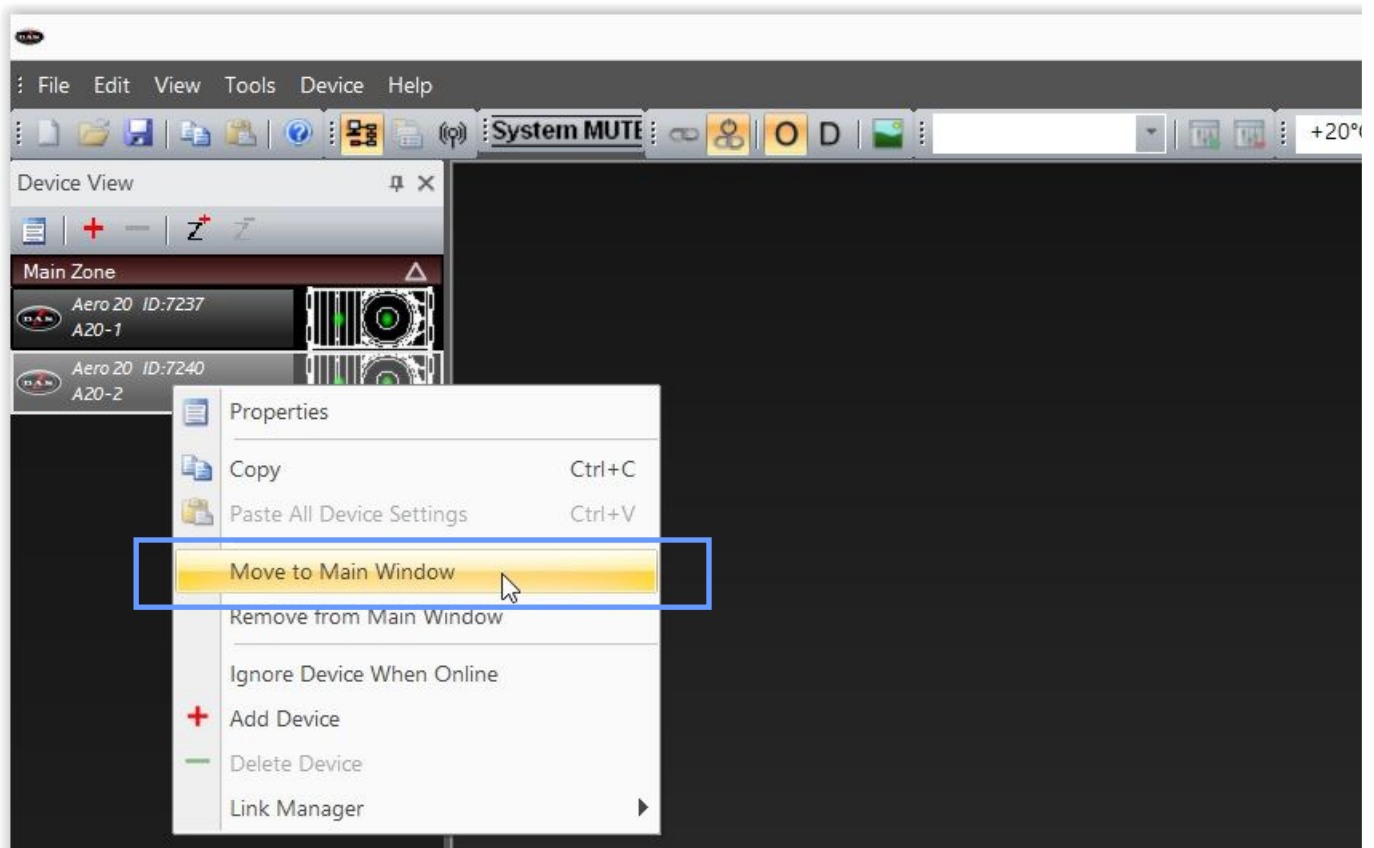

This is an example of a 24 x aero 20A system. All devices have been moved and organised in the main window:

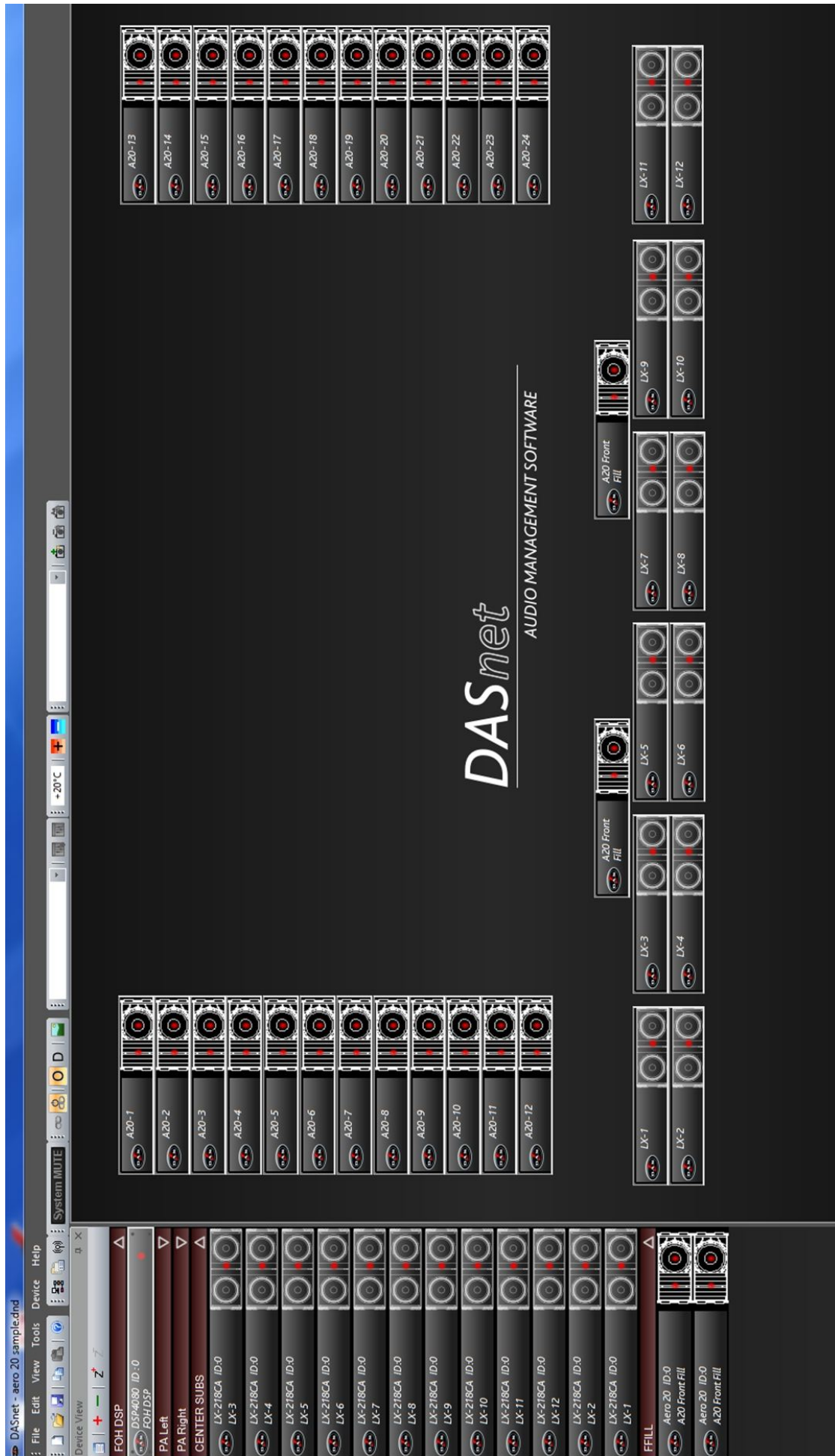

## Appendix 3. Snapshots

One way of changing parameters in a very fast way when using DASnet with audio processors and networkable cabinets is by the use of snapshots. It is like a fast “preset recall” that is stored in the DASnet \*.dnd file, not in the devices!

As a sample we are going to create two snapshots in a processor, one will link the output 5 of the processor to the input A, and the other will be linking the output 5 of the processor to inputs A and C.

To create a new snapshot, go to the snapshot window and click +, add new snapshot. The new snapshot stores the existing parameters in the software.

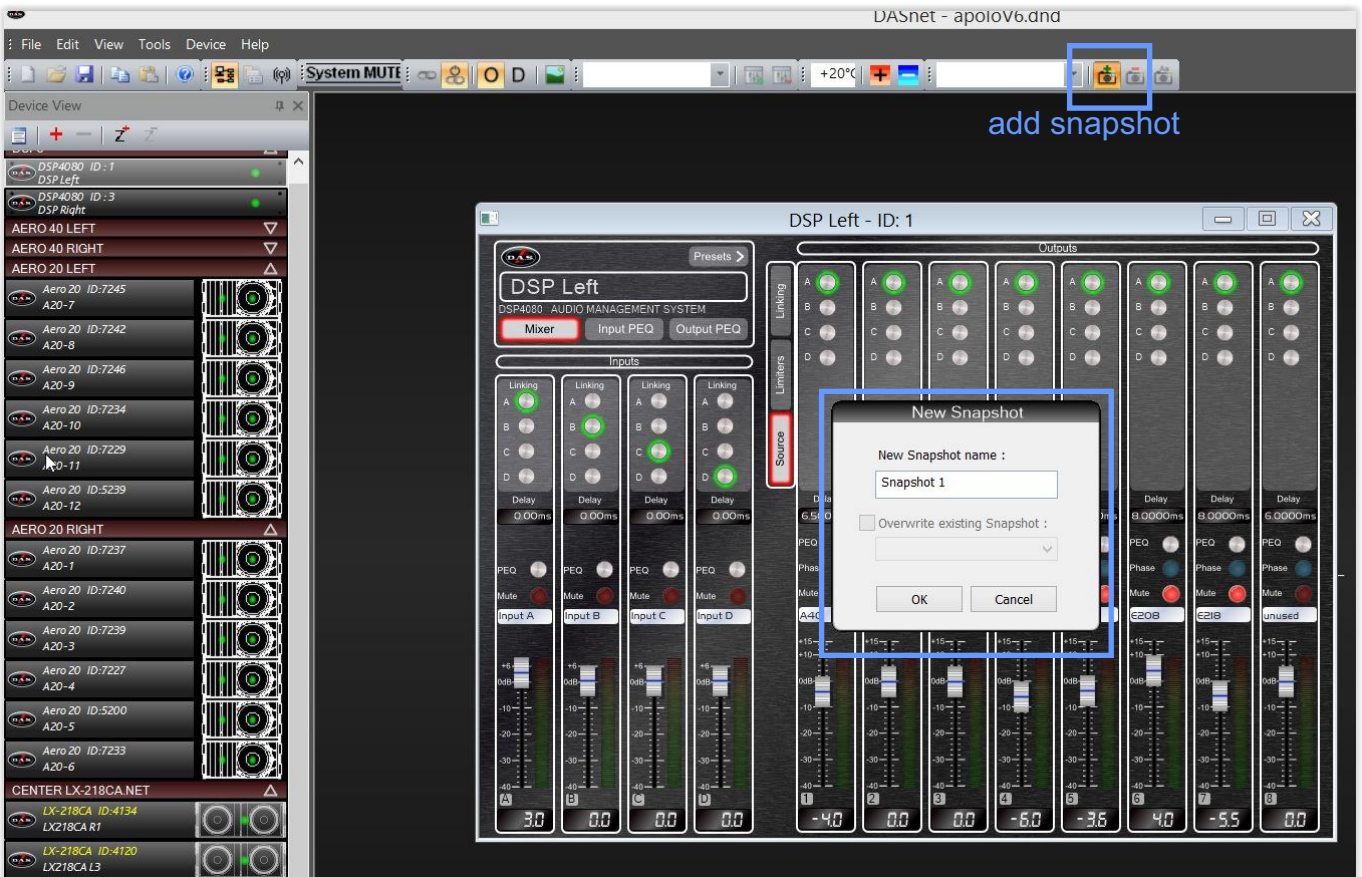

When creating the snapshot the out 5 of the processor is using inputA. Name is defined by user; in this case we call the snapshot *SUB MIX input A*:

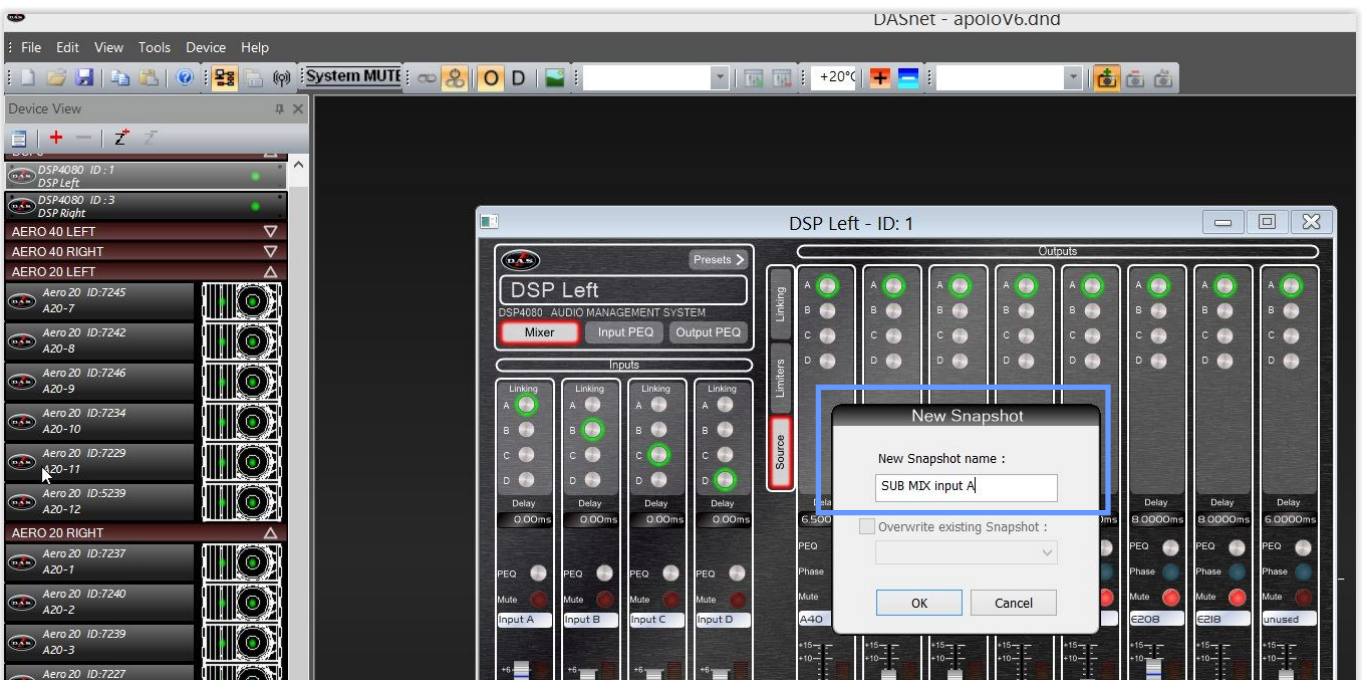



First Snapshot has been created. Now we modify parameters in the DSP and create the second one. We will link out 5 with inputs A and C:



Once the parameters have been changed the new snapshot can be created. We will name it *SUB MIX input A&C*.

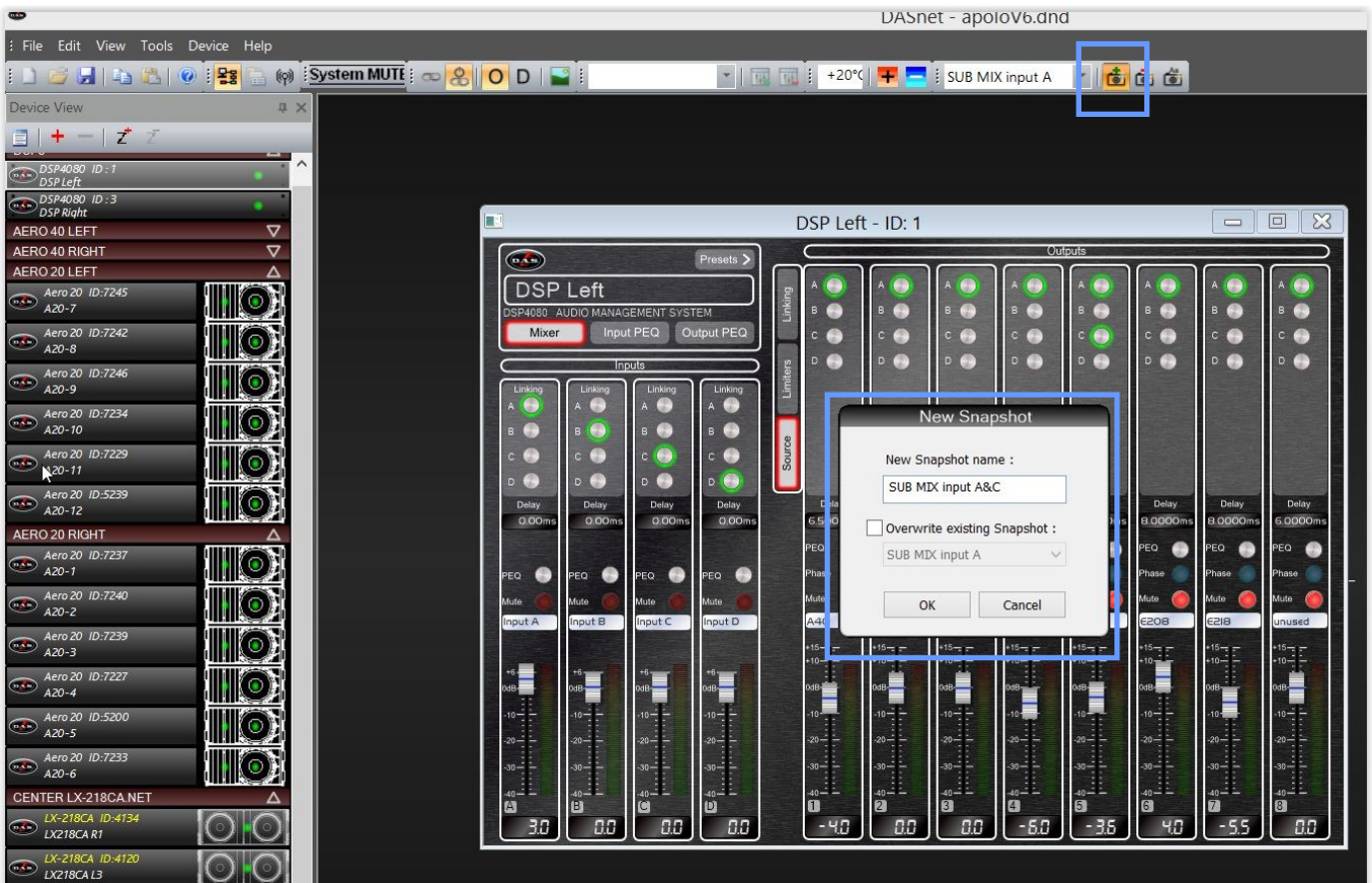



We have both snapshots created. To change from one to the other simply select the desired one in the snapshots control panel.

