

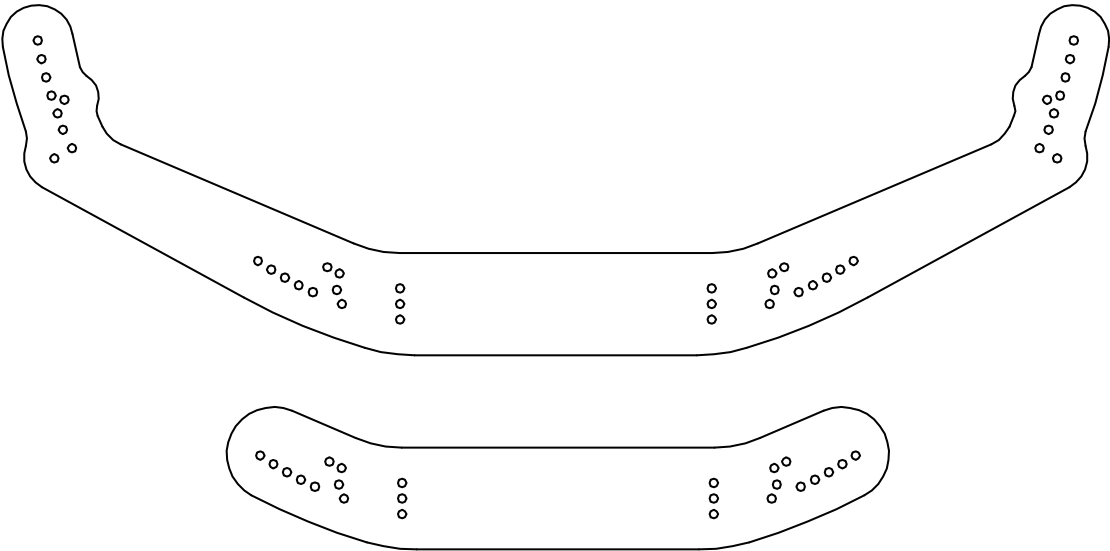

TPZ153-FK Bracket

Fly Plate Kit For TPZ153 Loudspeakers

Quickstart Guide



EN

LEGAL DISCLAIMER

MUSIC Group accepts no liability for any loss which may be suffered by any person who relies either wholly or in part upon any description, photograph, or statement contained herein. Technical specifications, appearances and other information are subject to change without notice. All trademarks are the property of their respective owners. MIDAS, KLARK TEKNIK, TURBOSOUND, BEHRINGER, BUGERA and DDA are trademarks or registered trademarks of MUSIC Group IP Ltd. © MUSIC Group IP Ltd. 2015 All rights reserved.

LIMITED WARRANTY

For the applicable warranty terms and conditions and additional information regarding MUSIC Group's Limited Warranty, please see complete details online at music-group.com/warranty.

NEGACIÓN LEGAL

MUSIC Group no admite ningún tipo de responsabilidad por cualquier daño o pérdida que pudiera sufrir cualquier persona por confiar total o parcialmente en la descripción, fotografías o afirmaciones contenidas en este documento. Las especificaciones técnicas, imágenes y otras informaciones contenidas en este documento están sujetas a modificaciones sin previo aviso. Todas las marcas comerciales que aparecen aquí son propiedad de sus respectivos dueños. MIDAS, KLARK TEKNIK, TURBOSOUND, BEHRINGER, BUGERA y DDA son marcas comerciales o marcas registradas de MUSIC Group IP Ltd. © MUSIC Group IP Ltd. 2015 Reservados todos los derechos.

GARANTÍA LIMITADA

Si quiere conocer los detalles y condiciones aplicables de la garantía así como información adicional sobre la Garantía limitada de MUSIC group, consulte online toda la información en la web music-group.com/warranty.

ES

FR

DE

PT

JP

CN

DÉNI LÉGAL

MUSIC Group ne peut être tenu pour responsable pour toute perte pouvant être subie par toute personne se fiant en partie ou en totalité à toute description, photographie ou affirmation contenue dans ce document. Les caractéristiques, l'apparence et d'autres informations peuvent faire l'objet de modifications sans notification. Toutes les marques appartiennent à leurs propriétaires respectifs. MIDAS, KLARK TEKNIK, TURBOSOUND, BEHRINGER, BUGERA et DDA sont des marques ou marques déposées de MUSIC Group IP Ltd. © MUSIC Group IP Ltd. 2015 Tous droits réservés.

GARANTIE LIMITÉE

Pour connaître les termes et conditions de garantie applicables, ainsi que les informations supplémentaires et détaillées sur la Garantie Limitée de MUSIC Group, consultez le site Internet music-group.com/warranty.

HAFTUNGSAUSSCHLUSS

MUSIC Group übernimmt keine Haftung für Verluste, die Personen entstanden sind, die sich ganz oder teilweise auf hier enthaltene Beschreibungen, Fotos oder Aussagen verlassen haben. Technische Daten, Erscheinungsbild und andere Informationen können ohne vorherige Ankündigung geändert werden. Alle Warenzeichen sind Eigentum der jeweiligen Inhaber. MIDAS, KLARK TEKNIK, TURBOSOUND, BEHRINGER, BUGERA und DDA sind Warenzeichen oder eingetragene Warenzeichen der MUSIC Group IP Ltd. © MUSIC Group IP Ltd. 2015 Alle Rechte vorbehalten.

BESCHRÄNKTE GARANTIE

Die geltenden Garantiebedingungen und zusätzliche Informationen bezüglich der von MUSIC Group gewährten beschränkten Garantie finden Sie online unter music-group.com/warranty.

LEGAL RENUNCIANTE

O MUSIC Group não se responsabiliza por perda alguma que possa ser sofrida por qualquer pessoa que dependa, seja de maneira completa ou parcial, de qualquer descrição, fotografia, ou declaração aqui contidas. Dados técnicos, aparências e outras informações estão sujeitas a modificações sem aviso prévio. Todas as marcas são propriedade de seus respectivos donos. MIDAS, KLARK TEKNIK, TURBOSOUND, BEHRINGER, BUGERA e DDA são marcas ou marcas registradas do MUSIC Group IP Ltd. © MUSIC Group IP Ltd. 2015 Todos direitos reservados.

GARANTIA LIMITADA

Para obter os termos de garantia aplicáveis e condições e informações adicionais a respeito da garantia limitada do MUSIC group, favor verificar detalhes na íntegra através do website music-group.com/warranty.

法的放棄

ここに含まれる記述、写真、意見の全体または一部に依拠して、いかなる人が損害を生じさせた場合にも、MUSIC Groupは一切の賠償責任を負いません。技術仕様、外観およびその他の情報は予告なく変更になる場合があります。商標はすべて、それぞれの所有者に帰属します。MIDAS、KLARK TEKNIK、TURBOSOUND、BEHRINGER、BUGERA および DDA は MUSIC Group IP Ltd. の商標または登録商標です。© MUSIC Group IP Ltd. 2015 無断転用禁止。

限定保証

適用される保証条件と MUSIC Group の限定保証に関する概要については、オンライン上 music-group.com/warranty にて詳細をご確認ください。

法律声明

对于任何因在此说明书提到的全部或部份描述、图片或声明而造成的损失, MUSIC Group 不负任何责任。技术参数和外观若有更改, 恕不另行通知。所有的商标均为其各自所有者的财产。MIDAS, KLARK TEKNIK, TURBOSOUND, BEHRINGER, BUGERA 和 DDA 是 MUSIC Group IP Ltd. 公司的商标或注册商标。© MUSIC Group IP Ltd. 2015 版权所有。

保修条款

有关音乐集团保修的适用条款及其它相关信息, 请登陆 music-group.com/warranty 网站查看完整的详细信息。

Thank you for choosing a TURBOSOUND loudspeaker product for your application. If you would like further information about this or any other product, please visit our website at turbosound.com.

Unpacking

After unpacking the unit, please check carefully for damage. If damage is found, please notify your supplier at once. You, the consignee, must instigate any claim. Please retain all packaging in case of future return shipment.

Mounting and Fixing

The TPZ153-FK fly kit allows suspension of 3 TPZ153 models. Array angles from 50 degrees to 90 degrees can be chosen in 5 degree increments. The fly kit comprises an upper and lower fly plate, 4 eyebolts and M10 fixings required for installation.

The cabinets are fitted with M10 x 13 internally-threaded rigging points that allow it to be rigged with optional shoulder eyebolts and mounted in many different configurations in permanent installations. Cabinets may also be hung upside down if required.

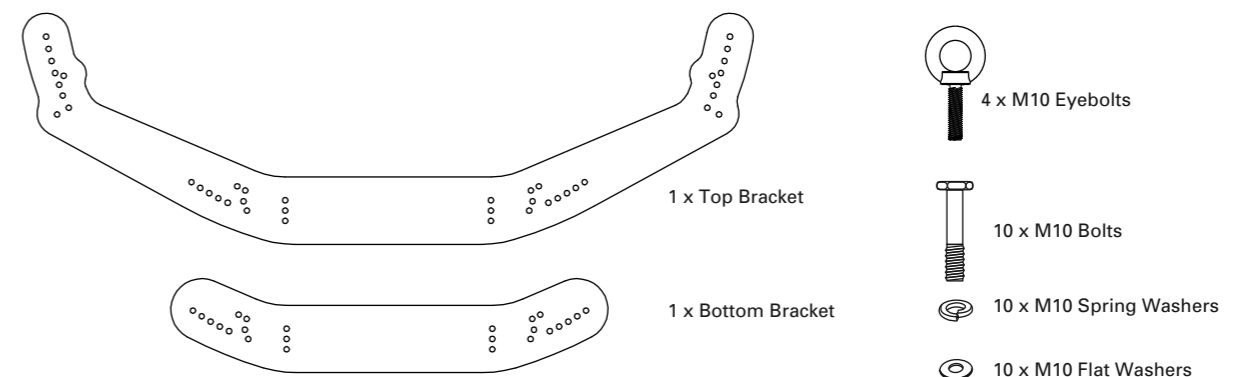
Contents

EN

EN

Assembly Instructions

1. Set the 3 speakers on the ground side-by-side facing the same direction.
2. Place the larger bracket (top plate) on top of the speakers and align them according to the desired array angle.
3. Place the spring washers over the 6 holes in the bracket where bolts will be attached.
4. Screw M10 flat bolts into the 2 inner holes first, then the 2 outer holes.
5. Screw M10 eyebolts into the remaining 2 holes. These will be used to suspend the cluster.
6. Tip the cluster backwards so that the speakers are facing directly upward. This will allow the bottom of the speakers to be accessed.
7. Hold the smaller bracket (bottom plate) up to the speakers so that the holes align with the threaded inserts. Place flat washers over 4 flat bolts and screw them in one at a time.
8. Return the speakers to their upright position. Additional eyebolts can be attached to the top of the speakers for additional support.
9. Screw either one eyebolt into the back of the middle speaker, or screw an eyebolt into the back of each of the outer speakers as a pull-back to allow the vertical angle to be adjusted.

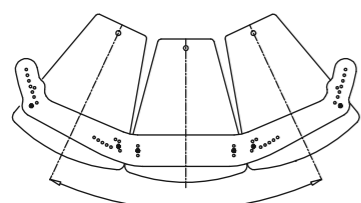
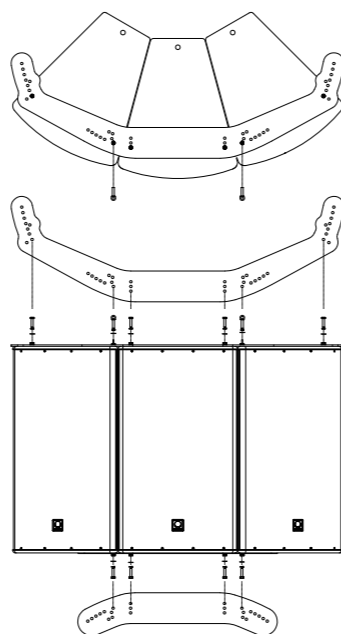

50 degrees

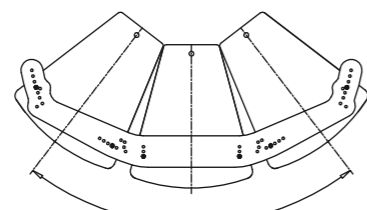

75 degrees

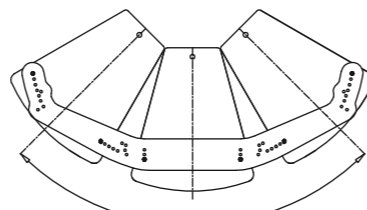

90 degrees

Adjustable angle from 50 to 90 degrees in 5 degree steps

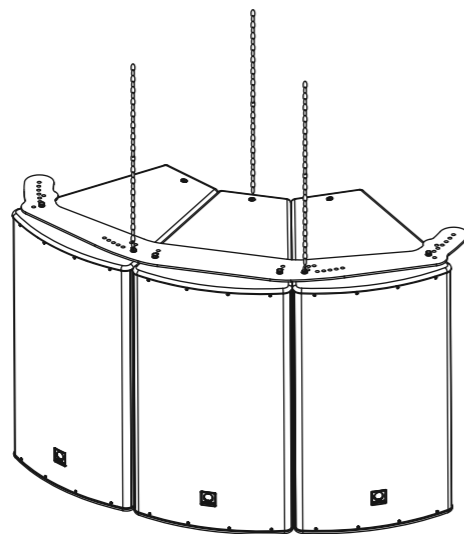

Horizontal array of three TPZ153/64 cabinets using the TPZ153-FK fly kit.

Suspending with Eyebolts

TPZ cabinets can be suspended using optional eyebolts coupled to the internal rigging points provided on the top, bottom and sides and back. The simplest method is to use the two rigging points on the top and a single pull-back rigging point in the centre of the rear panel.

Remove the appropriate countersunk screws and replace them with shoulder eyebolts, which must have a thread length of at least 18 mm. Use the rear rigging point to angle the cabinet for optimum room coverage. Cabinets may be hung upside down if required.

IMPORTANT NOTE: The mounting of a permanently installed sound system may be dangerous unless undertaken by qualified personnel with the required experience and certification to perform the necessary tasks. Walls, floors or ceilings must be capable of safely and securely supporting the actual load. The mounting accessory used must be safely and securely fixed both to the loudspeaker and to the wall, floor or ceiling.

When mounting rigging components on walls, floors or ceilings, ensure that all fixings and fasteners used are of an appropriate size and load rating. Wall and ceiling claddings, and the construction and composition of walls and ceilings, all need to be taken into account when determining whether a particular fixing arrangement can be safely employed for a particular load. Cavity plugs or other specialist fixings, if required, must be of an appropriate type, and must be fitted and used in accordance with the maker's instructions.

The operation of your speaker cabinet as part of a flown system, if installed incorrectly and improperly, can potentially expose persons to serious health risks and even death. In addition, please ensure that electrical, mechanical and acoustic considerations are discussed with qualified and certified (by local state or national authorities) personnel prior to any installation or flying.

Make sure that speaker cabinets are set up and flown by qualified and certified personnel only, using dedicated equipment and original parts and components delivered with the unit. If any parts or components are missing please contact your dealer before attempting to set up the system.

Be sure to observe the local, state and other safety regulations applicable in your country. MUSIC Group, including the MUSIC Group companies listed on the enclosed "Service Information Sheet", assumes no liability for any damage or personal injury resulting from improper use, installation or operation of the product. Regular checks must be conducted by qualified personnel to ensure that the system remains in a secure and stable condition. Make sure that, where the speaker is flown, the area underneath the speaker is free of human traffic. Do not fly the speaker in areas that can be entered or used by members of the public.

Speakers create a magnetic field, even if not in operation. Therefore, please keep all materials that can be affected by such fields (discs, computers, monitors, etc) at a safe distance. A safe distance is usually between 1 and 2 metres.

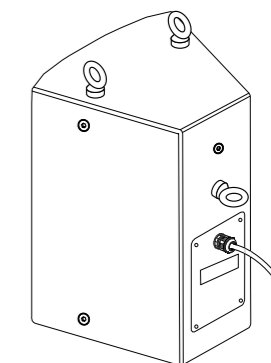

EN

