

# **UMCWB and UMCWBL**

## **Wideband UHF Diversity Antenna Multicouplers**



- **Assembly and Installation**
- **Antenna Types**

Fill in for your records:

Serial Number:

Purchase Date:



# Table of Contents

<b>General Technical Description</b> .....	<b>4</b>
RF/Power Distribution Module Block Diagram .....	4
Antenna Input .....	5
Power Supply .....	5
<b>Assembly and Installation</b> .....	<b>6</b>
Installing the Receivers .....	6
Installing the Wire Cover .....	7
Installing the Assembled Unit.....	7
<b>Antenna Types and Bandwidth</b> .....	<b>8</b>
<b>Antenna Use and Placement</b> .....	<b>9</b>
<b>Accessories</b> .....	<b>10</b>
<b>Specifications</b> .....	<b>10</b>
<b>Service and Repair</b> .....	<b>11</b>
Returning Units for Repair .....	11

# General Technical Description

The purpose of wideband architecture is to provide the flexibility needed to deal with a changing RF environment, and for mobile productions that cover broad geographic areas. The UMCWB provides a mechanical rack mount with power and RF signal distribution for four diversity compact receivers in a single rack space. The standard version covers frequency blocks from 21 through 29. The wideband low version covers frequency blocks from 470 through 26.

The RF multicoupler preserves the sensitivity and overload performance of the finest receivers. Selective filtering in the front end attenuates RF signals above and below the passband to suppress intermodulation and noise. Following the filters is a low noise RF amplifier with gain matched to compensate for the losses in the splitter that follows.

A precision strip line splitter/isolator divides the RF signal into four isolated signals preventing spurious RF coupling between receivers. The splitter/isolator is termination independent which prevents mismatched or disconnected RF outputs from affecting the other receivers.

The assembly is powered from an external source of 11 to 18 VDC with individual auto-reset fuses for each receiver in the RF/power distribution module. This architecture eliminates ground loops and AC hum that can occur when the receiver outputs are connected to other audio equipment operating from a different AC source.

## RF/Power Distribution Module Block Diagram

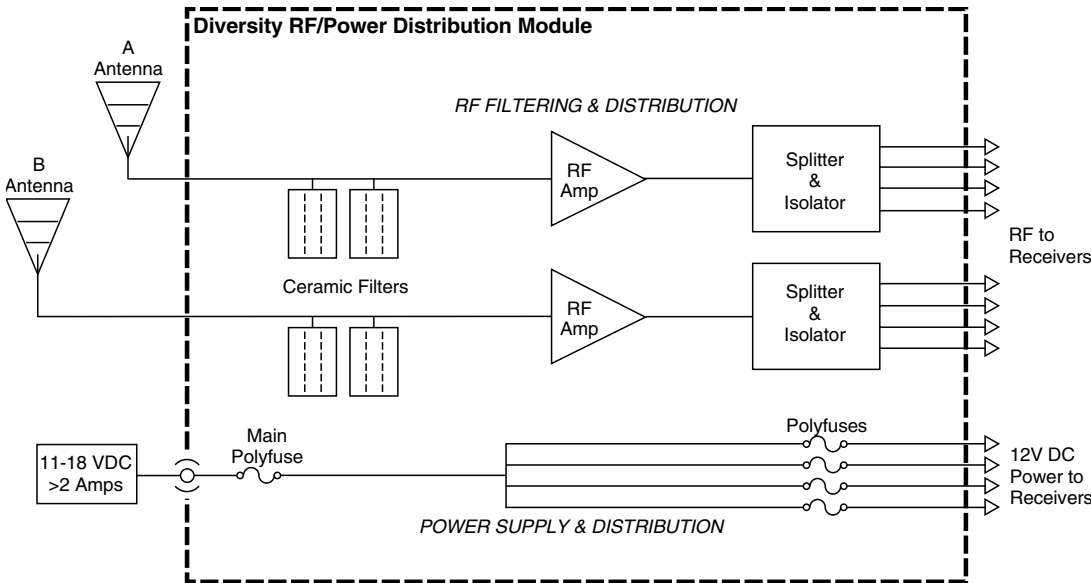

## Antenna Input

Standard 50 ohm BNC connectors are used for the antenna inputs and signal distribution. The RF signals are fed to the receivers via coaxial cables that loop through the front panel to the receiver inputs. The leads are labeled as "A" and "B" and routed so that each receiver has one of each connected for diversity reception.

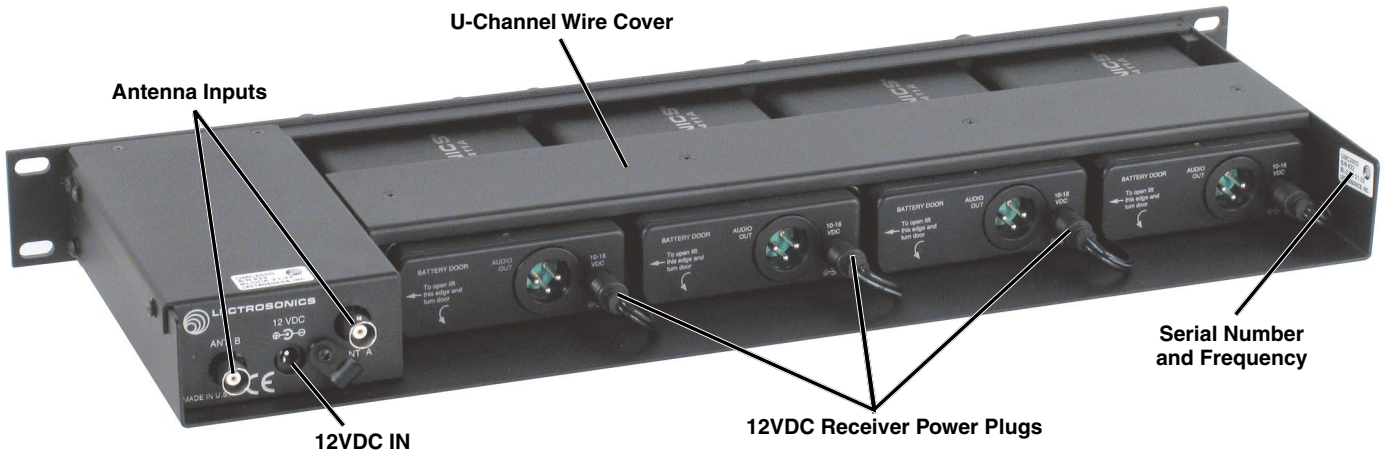
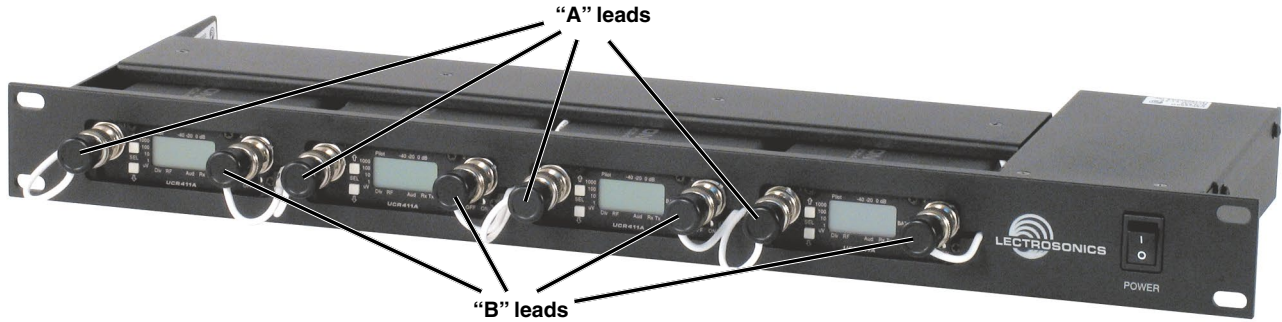

## Power Supply

The multi-coupler is powered by external 12 VDC (11 to 18 VDC is acceptable). The center pin of the input jack is positive. The power supply must be capable of handling up to 2 amps of current. DC power is distributed to the receivers via rear panel pigtail connectors.

The Lectrosonics DCR15/2AU is a switching power supply with coaxial connector matched to the 12VDC power jack on the multicoupler. The AC receptacle is a standard, grounded IEC 60320 C14 inlet socket that will accept common cords like those used on computer equipment (AC cord is not included). Output cable is 6 ft. long.

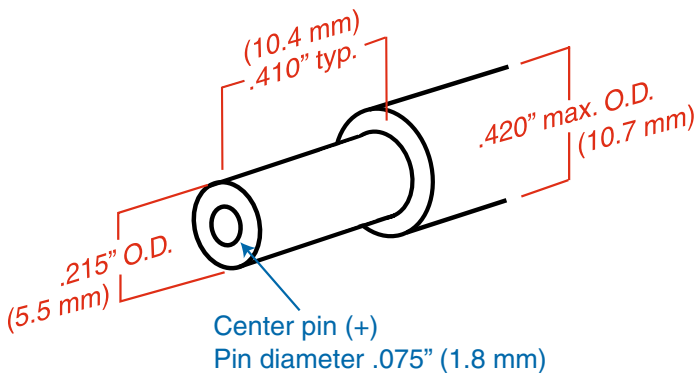

# Assembly and Installation

Assembly of the unit consists of installing the receivers in the frame and connecting the antenna leads and power cables to each receiver.

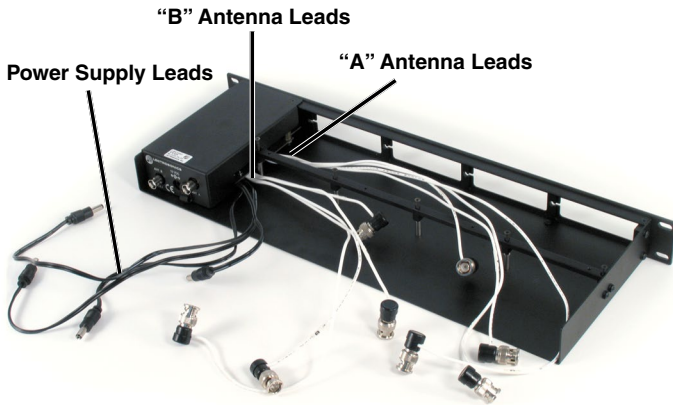

## Installing the Receivers

1. Remove the U-channel wire cover by completely removing the four counter-sunk phillips head screws from the top of the unit. Underneath the U-channel wire cover is a rectangular metal bar held down by five counter-sunk phillips head screws. Loosen these five screws five to seven turns (it's not necessary to remove them completely.)

*Note: Before installing the receivers, be sure to record the serial numbers and frequencies. This information is printed on the side panel labels which won't be visible after installation.*

2. Route the three longest "B" antenna leads behind the post nearest the housing as shown here. Remove the screw from the post next to the housing if necessary to route the longer "B" leads. The shortest "B" lead should be routed along the housing directly to the front panel.

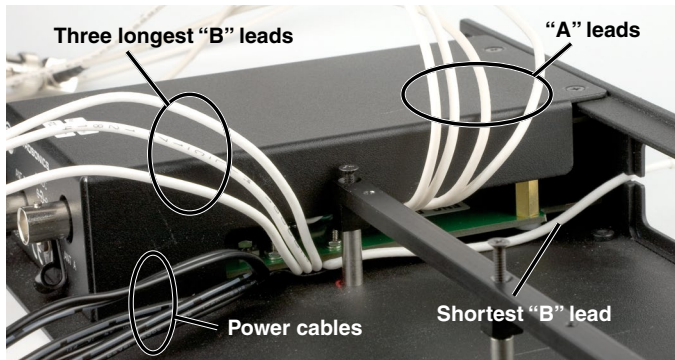

Cable routing prior to assembly

3. Route the antenna leads through the slots on the front of the frame before mounting the receivers. Start with the shortest "A" lead and the shortest "B" lead for the receiver closest to the power supply, then the next shortest A and B leads for the next receiver, and so forth. Each diversity receiver must be connected to an "A" lead and a "B" lead for diversity reception.

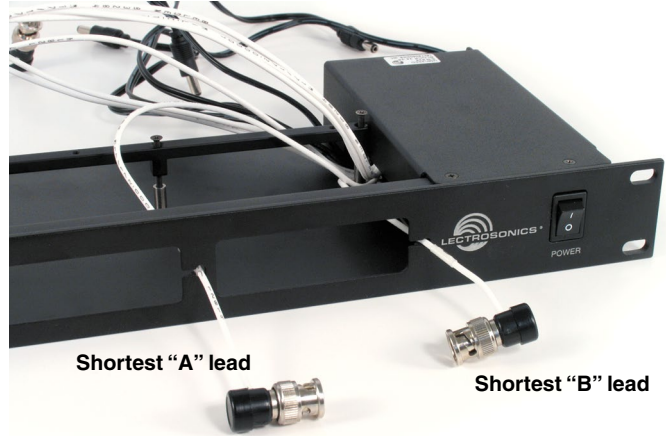

4. Insert the first receiver into the slot nearest to the power switch by sliding it under the wiring harness and the rectangular metal bar. Be sure the front panel of the receiver is fully inserted into the cutout on the inside of the front panel. Install the remaining receivers in the same manner.



5. Secure the receivers into the frame by tightening the five counter-sunk phillips head screws in the rectangular metal rod. **Don't overtighten!**



*With each receiver, route the "B" antenna cable under the bar and place it in the gap next to the screw.*



6. The power cables can be routed outside of the U-channel cover, or routed under the U-channel cover alongside the antenna leads.

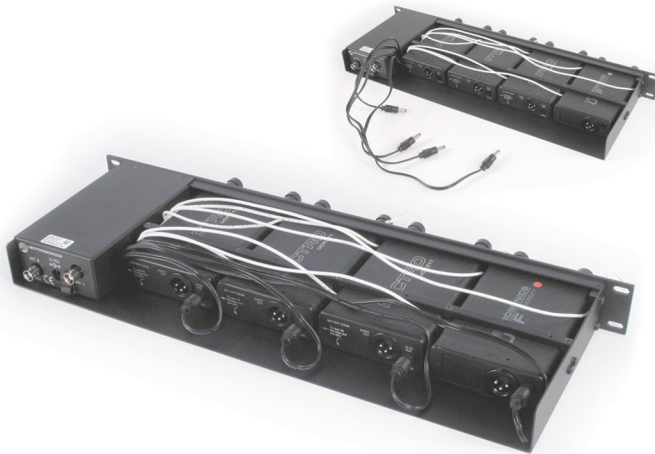

Note: If you opt to run the power cords outside of the U-channel along the back of the receivers, they might be unplugged accidentally.

## Installing the Wire Cover

Installing the U-channel wire cover can be difficult if the power cables are routed with the antenna leads under the U-channel wire cover. The cables must lay flat and straight, and not overlap to allow the wire cover to lay flush with the rack mount. The technique described here is the easiest way to install the U-channel wire cover,

- Dress the antenna and power cables so that the bundle is as flat as possible. Make sure no wires are on top of the metal bar.
- Starting at the end opposite the power supply, carefully place the U-channel wire cover over the wiring bundle and press down.
- While keeping downward pressure on the U-channel, slide it to the left over the wire bundle.
- As you move the U-channel across the bundle, dress the cables with your other hand to make sure the wires remain as flat and neatly aligned as possible. The power cords in particular need to lie flat and not overlap each other.
- While holding the U-channel down, insert the four phillips head screws and tighten them slowly while watching the wires to make sure none are pinched.

## Installing the Assembled Unit

Mount the assembled frame into the rack, connect the antenna and an appropriate power supply. There are no special ventilation requirements.

A:



B:



C:



D:



E:



# Antenna Types and Bandwidth

While the wide bandwidth of the multi-coupler is very convenient, it also requires that the antennas used with it also have a bandwidth wide enough to cover the range of the receivers that are installed. If the entire bandwidth from block 21 through block 29 is to be used, the best antenna would be one of the ALP Series log periodic models.



ALP620 Log-periodic antenna

The ALP Series antennas are ideal for use with wide-band multicouplers, offering a directional coverage pattern and a gain of 4.5 dBd. Three different models are available to suit your specific needs.

Whip antennas can only be used if the frequency block of the antennas is the same as the installed receivers, or one block higher or lower. For example, block 24, 25 and 26 receivers can be used with block 25 antennas.



Whip antennas can be used as long as the frequency band matches the receivers installed in the multi-coupler.

If a circular pattern is needed, the SNA600 dipole model is an excellent choice, however, it is limited to a 100 MHz bandwidth (about 4 blocks). It is tuned to match the frequencies of the installed receivers by adjusting the length of the elements according to the scale on the body of the antenna. It is supplied with a mounting strap, hardware and a rotatable mounting block, and folds for storage.



The SNA600 dipole antenna folds for storage

To achieve wideband, circular coverage, two SNA600 antennas tuned to different frequency ranges can be used with an external combiner, however, loss could occur depending upon how they are positioned and how much overlap exists in their tuning ranges.

To reduce the interaction between two SNA600 antennas, mount them in a vertical orientation, about a half wavelength apart, so they will be in each other's null. In theory, there will be some noise generated by mixing the signal from the "out of band" antenna with the intended one, but it is likely to be inconsequential in actual use.

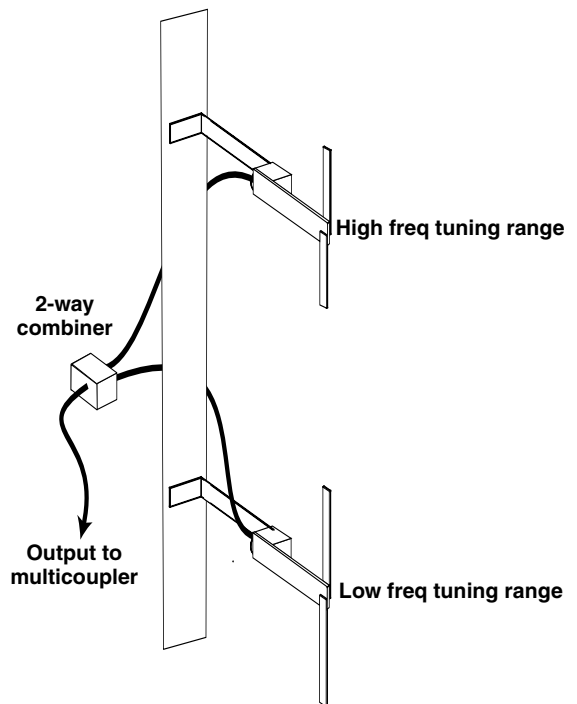



# Antenna Use and Placement

Try to position the antennas so that they are not within 3 or 4 feet of large metal surfaces. It is also good to maintain a direct "line of sight" between the transmitter and the receiver antennas. In situations where the operating range is less than about 50 feet, the antenna positioning is much less critical.

A wireless transmitter sends a radio signal out in all directions. This signal will often bounce off nearby walls, ceilings, metal surfaces, etc. and a strong reflection can arrive at the receiver antenna along with the direct signal. If the direct and reflected signals are out of phase with each other a cancellation will occur as the signals mix at the antenna input. The result will be a "drop-out."

A drop-out usually sounds like a brief noise burst, click, pop, or something similar. In severe cases, it may result in a complete loss of the carrier and the sound. A drop-out situation may be either better or worse as a crowd fills and/or leaves the room, or when the transmitter and receiver antennas are moved to different locations.

Diversity receiver designs include a method of selecting or combining two antennas to reduce or eliminate drop-outs. The antennas must be placed at least a half wavelength apart to achieve a noticeable reduction in drop-outs, or better yet, several feet apart.

It is generally best to use two of the same type antennas on a diversity receiver, as some designs combine both antenna signals into a single receiver with a phase correction between them to maximize the resultant RF signal. If one antenna signal is significantly stronger than the other, the signal from the weaker antenna will do little to prevent multipath drop-outs that occur at the stronger antenna.

The diagram below depicts a classic multipath drop-out situation. In some diversity designs, a second antenna in a different location is selected instead of the first antenna, following the logic that a multipath drop-out is not likely to occur simultaneously at both antennas. Other designs combine the two antenna signals and control the phase of one of them to make sure they always add to each to provide a stronger signal.

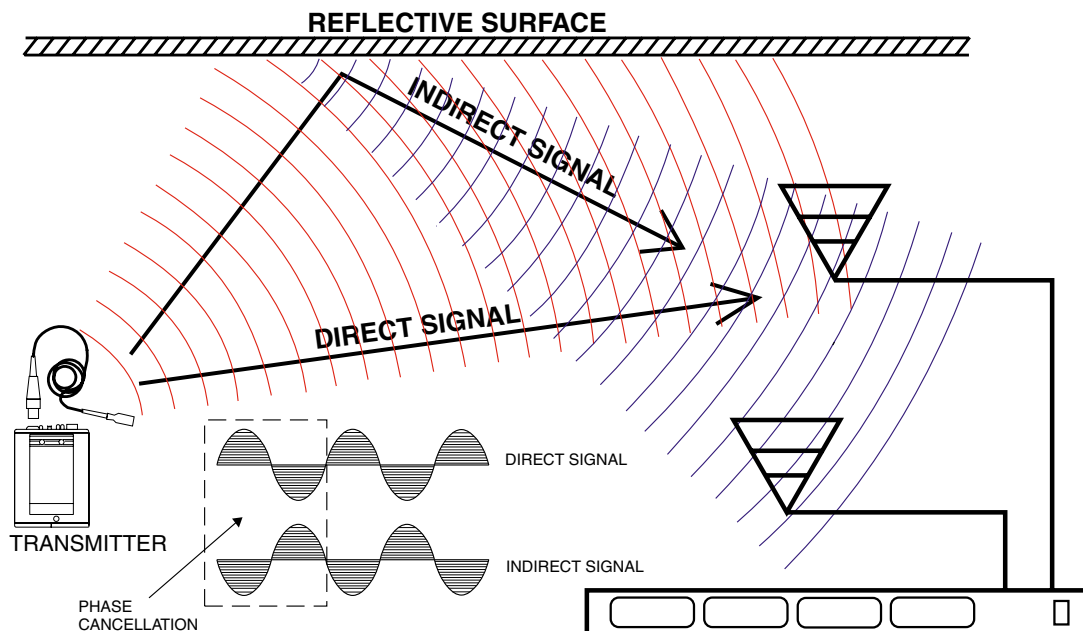

## Accessories

<b>ARG2</b>	RF coaxial cable assembly, 2ft length, BNC male connectors
<b>ARG15</b>	RF coaxial cable assembly, 15 ft. length, BNC male connectors
<b>ARG25</b>	RF coaxial cable assembly, 25 ft. length, BNC male connectors
<b>ARG50</b>	RF coaxial cable assembly, 50 ft. length, BNC male connectors
<b>ARG100</b>	RF coaxial cable assembly, 100 ft. length, BNC male connectors
<b>ALP500</b>	Log periodic dipole array (“shark fin”) antenna; standard version
<b>ALP620</b>	Log periodic dipole array (“shark fin”) antenna; “skeletal” body reduces wind loading in outdoor use
<b>ALP650</b>	Log periodic dipole array (“shark fin”) antenna; built-in RF amplifier with adjustable gain
<b>SNA600</b>	Tunable dipole antenna; 100 MHz bandwidth
<b>PF25</b>	Passive inline filter; 30 MHz bandwidth; BNC to BNC connectors; bidirectional
<b>PF50</b>	Passive inline filter with bias-T; 50 MHz bandwidth; BNC to BNC connectors
<b>PS70</b>	Power supply; 100-240 VAC; 13.8 VDC, 2.8 A output

## Specifications

RF Gain:	0.5 to 1.5dB
Bandwidth:	UMCWB: 537 to 768 MHz. UMCWBL: 470 to 692 MHz
RF Outputs:	Eight outputs, 50 Ohm, BNC
Isolation between outputs:	25 dB or greater
	Any output can be open, shorted or terminated without affecting other outputs.
Splitter type:	Wilkinson 1/4 wave
Filtering:	Two pole ceramic filter per antenna
Noise figure:	3.5dB
Third Order Intercept:	+27 dBm (input or output)
Power Input:	+11 to +18V DC;
Power Consumption:	2 amps max.
Antenna Connectors:	50 ohm BNC
Short Circuit Protection:	Auto-reset thermal fuses
Construction:	Machined aluminum panels and housings.
Dimensions:	19" wide, 1.75" high, 6.5" deep
Weight:	5 lbs. (typical) including 4 receivers

Specifications subject to change without notice.

This product meets the CE Compliance Standards - EN55022 and EN50082-1:1998. A copy of the Declaration of Conformity may be requested from your dealer or by contacting the factory directly:

Lectrosonics, Inc.  
 Marketing Department  
 581 Laser Rd. NE, Rio Rancho, NM 87124 USA  
 tel: 505-892-4501 fax: 505-892-6243  
 e-mail: marketing@lectrosonics.com

## Service and Repair

If your system malfunctions, you should attempt to correct or isolate the trouble before concluding that the equipment needs repair. Make sure you have followed the setup procedure and operating instructions. Check the interconnecting cables and then go through the **Troubleshooting** section in this manual.

We strongly recommend that you **do not** try to repair the equipment yourself and **do not** have the local repair shop attempt anything other than the simplest repair. If the repair is more complicated than a broken wire or loose connection, send the unit to the factory for repair and service. Don't attempt to adjust any controls inside the units. Once set at the factory, the various controls and trimmers do not drift with age or vibration and never require readjustment. **There are no adjustments inside that will make a malfunctioning unit start working.**

LECTROSONICS' Service Department is equipped and staffed to quickly repair your equipment. In warranty repairs are made at no charge in accordance with the terms of the warranty. Out-of-warranty repairs are charged at a modest flat rate plus parts and shipping. Since it takes almost as much time and effort to determine what is wrong as it does to make the repair, there is a charge for an exact quotation. We will be happy to quote approximate charges by phone for out-of-warranty repairs.

### Returning Units for Repair

For timely service, please follow the steps below:

- A. DO NOT return equipment to the factory for repair without first contacting us by email or by phone. We need to know the nature of the problem, the model number and the serial number of the equipment. We also need a phone number where you can be reached 8 A.M. to 4 P.M. (U.S. Mountain Standard Time).
- B. After receiving your request, we will issue you a return authorization number (R.A.). This number will help speed your repair through our receiving and repair departments. The return authorization number must be clearly shown on the **outside** of the shipping container.
- C. Pack the equipment carefully and ship to us, shipping costs prepaid. If necessary, we can provide you with the proper packing materials. UPS is usually the best way to ship the units. Heavy units should be "double-boxed" for safe transport.
- D. We also strongly recommend that you insure the equipment, since we cannot be responsible for loss of or damage to equipment that you ship. Of course, we insure the equipment when we ship it back to you.

#### Lectrosonics USA:

**Mailing address:**  
Lectrosonics, Inc.  
PO Box 15900  
Rio Rancho, NM 87174  
USA

**Shipping address:**  
Lectrosonics, Inc.  
581 Laser Rd.  
Rio Rancho, NM 87124  
USA

**Telephone:**  
(505) 892-4501  
(800) 821-1121 Toll-free  
(505) 892-6243 Fax

**Web:**  
[www.lectrosonics.com](http://www.lectrosonics.com)

**E-mail:**  
[sales@lectrosonics.com](mailto:sales@lectrosonics.com)

#### Lectrosonics Canada:

**Mailing Address:**  
720 Spadina Avenue,  
Suite 600  
Toronto, Ontario M5S 2T9

**Telephone:**  
(416) 596-2202  
(877) 753-2876 Toll-free  
(877-7LECTRO)  
(416) 596-6648 Fax

**E-mail:**  
Sales: [colinb@lectrosonics.com](mailto:colinb@lectrosonics.com)  
Service: [joeb@lectrosonics.com](mailto:joeb@lectrosonics.com)

## LIMITED ONE YEAR WARRANTY

The equipment is warranted for one year from date of purchase against defects in materials or workmanship provided it was purchased from an authorized dealer. This warranty does not cover equipment which has been abused or damaged by careless handling or shipping. This warranty does not apply to used or demonstrator equipment.

Should any defect develop, Lectrosonics, Inc. will, at our option, repair or replace any defective parts without charge for either parts or labor. If Lectrosonics, Inc. cannot correct the defect in your equipment, it will be replaced at no charge with a similar new item. Lectrosonics, Inc. will pay for the cost of returning your equipment to you.

This warranty applies only to items returned to Lectrosonics, Inc. or an authorized dealer, shipping costs prepaid, within one year from the date of purchase.

This Limited Warranty is governed by the laws of the State of New Mexico. It states the entire liability of Lectrosonics Inc. and the entire remedy of the purchaser for any breach of warranty as outlined above. NEITHER LECTROSONICS, INC. NOR ANYONE INVOLVED IN THE PRODUCTION OR DELIVERY OF THE EQUIPMENT SHALL BE LIABLE FOR ANY INDIRECT, SPECIAL, PUNITIVE, CONSEQUENTIAL, OR INCIDENTAL DAMAGES ARISING OUT OF THE USE OR INABILITY TO USE THIS EQUIPMENT EVEN IF LECTROSONICS, INC. HAS BEEN ADVISED OF THE POSSIBILITY OF SUCH DAMAGES. IN NO EVENT SHALL THE LIABILITY OF LECTROSONICS, INC. EXCEED THE PURCHASE PRICE OF ANY DEFECTIVE EQUIPMENT.

This warranty gives you specific legal rights. You may have additional legal rights which vary from state to state.

