

## Touring Speakers

# FLASHLINE MONITOR TFM152M

Co-axial 2 Way 15" Stage Monitor for  
Touring Applications



- 2 way stage monitor for touring applications
- 350 Watts continuous, 1,400 Watts peak power
- Carbon fibre loaded 15" neodymium motor low frequency driver
- Titanium dome 1.4" neodymium motor compression driver
- Low profile design to maximise audience sight lines
- Low distortion waveguide provides 60° H x 40° V dispersion
- Switchable passive/bi-amp operation for flexibility of use
- 15 mm (5/8") plywood enclosure with fibre glass reinforced composite end cheeks
- Hard wearing semi matt black paint finish
- Rugged powder coated perforated steel mesh grille
- Durable handle for easy lifting and carrying
- Neutrik speakON\* NL4 connectors for reliable long life operation
- 3-Year Warranty Program\*
- Designed and engineered in the U.K.

The 2-way full range TFM152M is a switchable passive/bi-amp 1,400 Watt 15" loudspeaker system that is ideally suited for a wide range of portable speech and music sound reinforcement applications. The TMS122M is designed to work in conjunction with LAB GRUPPEN amplification and loudspeaker management systems, the TFM152M provides optimal performance for wedge monitoring and is an exceptional choice for FOH, sidefill and delay line applications.

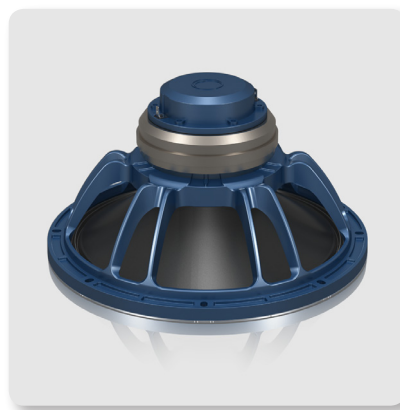

### Custom-Engineered Drivers

TURBOSOUND is recognised the world over for designing and building some of the most iconic loudspeakers and subwoofers. We take meticulous care and pride in maintaining that reputation by utilising only drivers designed specifically for each application – it's what sets us apart from the competition. The TFM152M loudspeaker features a carbon fibre loaded 15" neodymium low frequency driver and a titanium dome 1.4" neodymium high frequency compression driver, which is mounted on a 60° horizontal by 40° vertical dispersion low distortion waveguide.

Touring Speakers

# FLASHLINE MONITOR

## TFM152M

Co-axial 2 Way 15" Stage Monitor for Touring Applications

### Plywood Construction

Finished in a highly durable semi matt black paint, the cabinet is constructed from 15 mm (5/8") plywood with fibre glass reinforced composite end cheeks and a rugged powder coated perforated steel mesh grille backed with reticulated foam. The TFM152M includes a convenient pole mount socket for use with 35 mm poles/speaker stands to optimise coverage and a durable handle for easy transport. The side panels carry two Neutrik speakON® NL4 connectors for input and link connections to additional enclosures. TFM152M's low profile design provides improved audience line of sight for seamless integration into any application.



### Touring-Grade Performance

Designed to provide exceptional and unobtrusive onstage performance for travelling musicians, houses of worship, banquet facilities, night clubs – and a host of other venues, the 1,400-Watt TFM152M puts touring-grade sound quality into a scalable loudspeaker system that is supremely portable and versatile.

### You Are Covered

We always strive to provide the best possible Customer Experience. Our products are made in our own MUSIC Group factory using state-of-the-art automation, enhanced production workflows and quality assurance labs with the most sophisticated test equipment available in the world. As a result, we have one of the lowest product failure rates in the industry, and we confidently back it up with a generous 3-Year Warranty program.



Touring Speakers

# FLASHLINE MONITOR

## TFM152M

Co-axial 2 Way 15" Stage Monitor for Touring Applications

### Frequency Response Sensitivity 1 W / 1 m

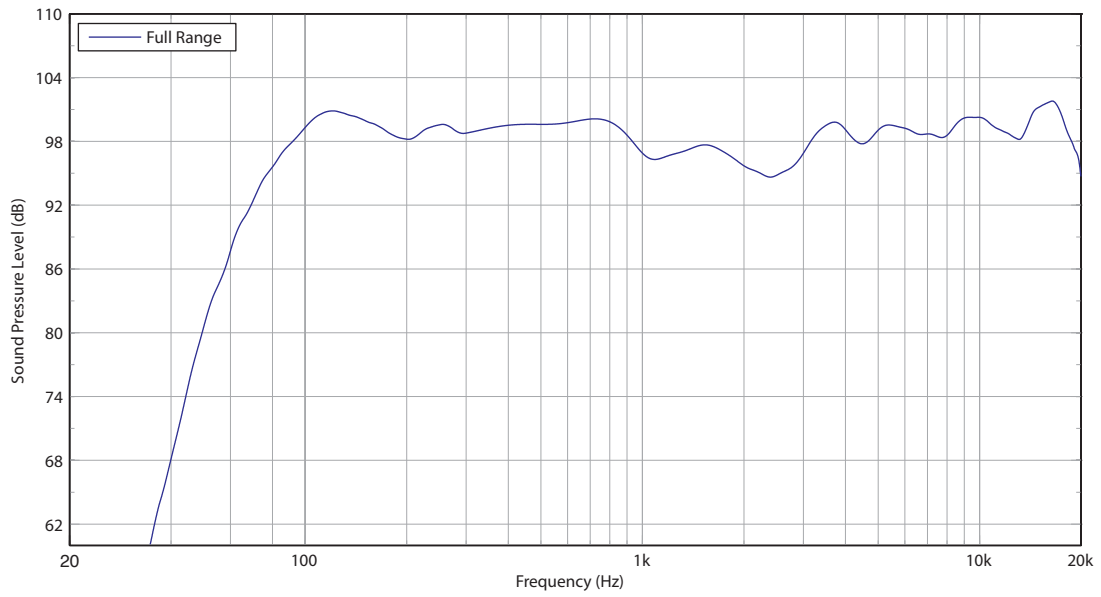

### Impedance

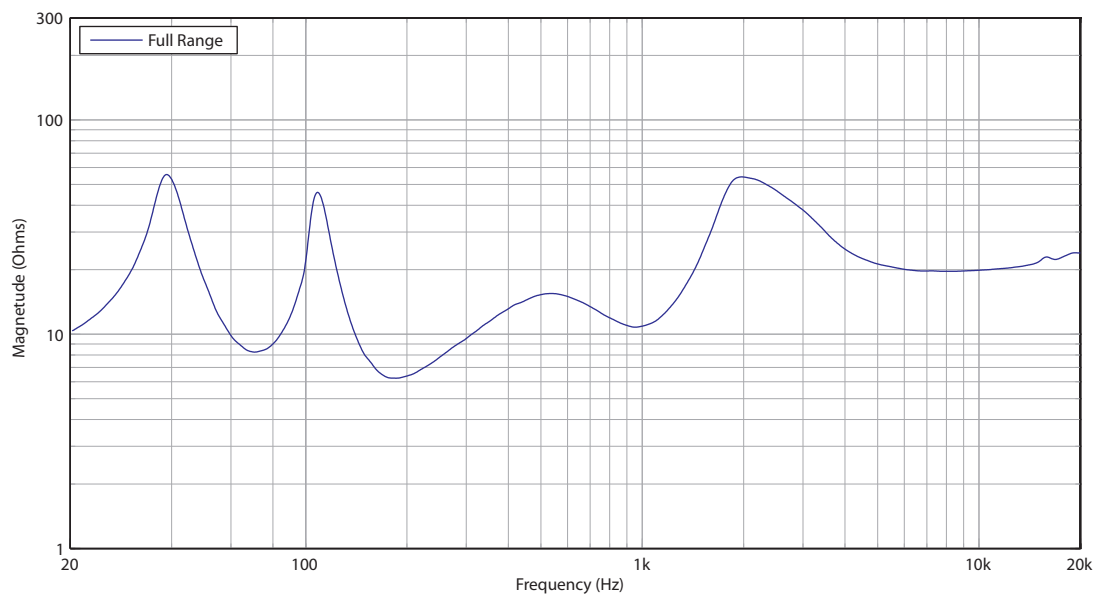

Touring Speakers

# FLASHLINE MONITOR

## TFM152M

Co-axial 2 Way 15" Stage Monitor for Touring Applications

### Horizontal Beamwidth

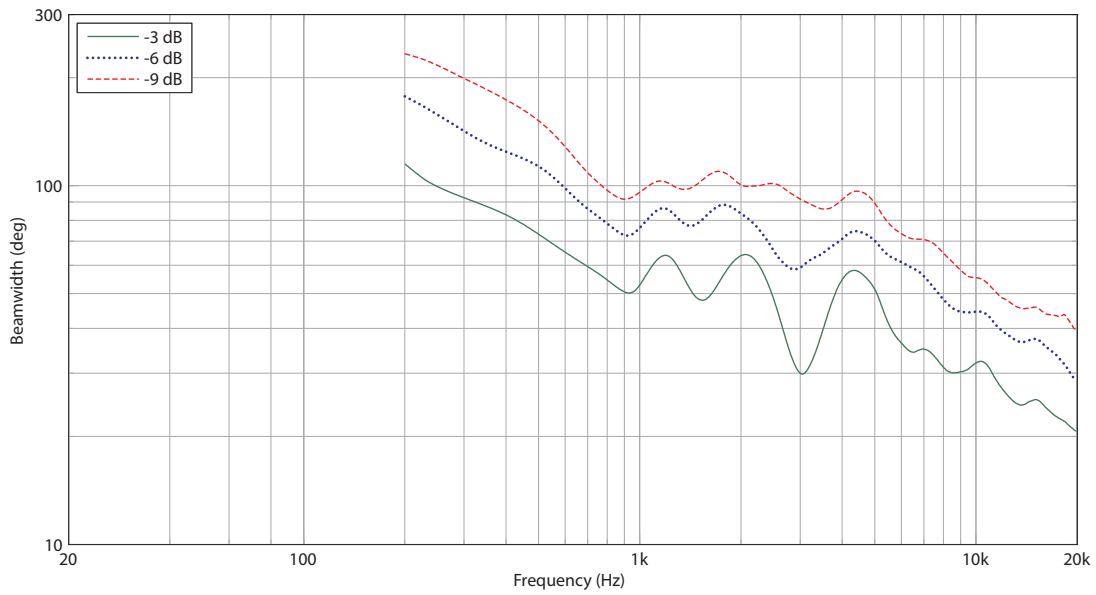

### Vertical Beamwidth

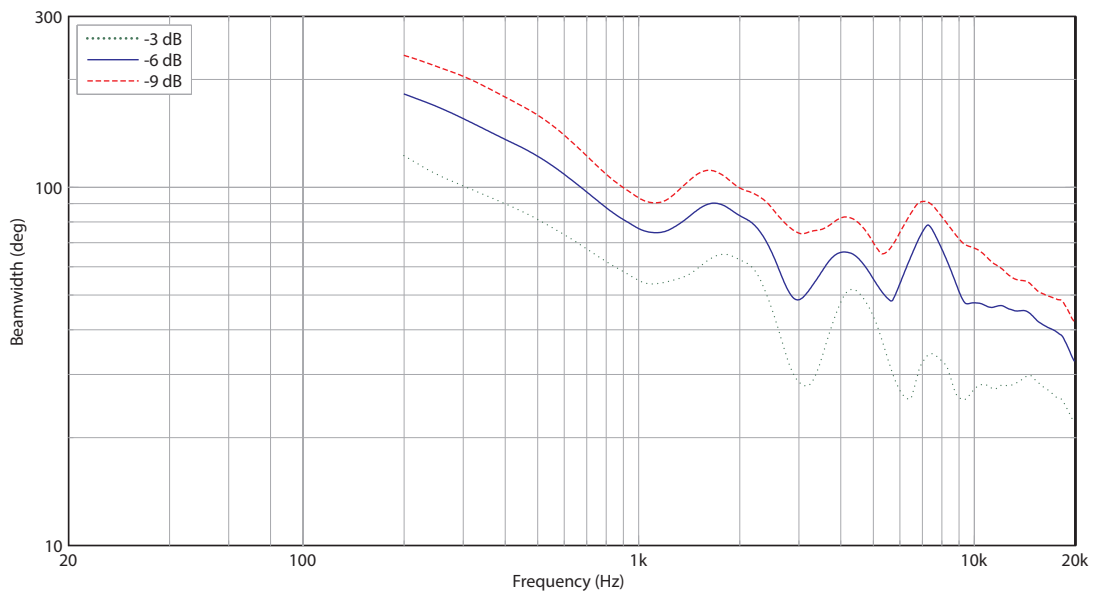

Touring Speakers

# FLASHLINE MONITOR TFM152M

Co-axial 2 Way 15" Stage Monitor for  
Touring Applications

## Horizontal Polar Plots

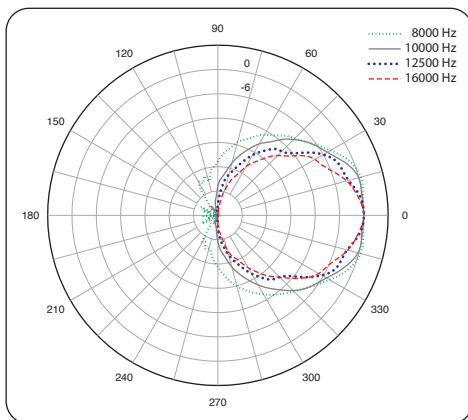
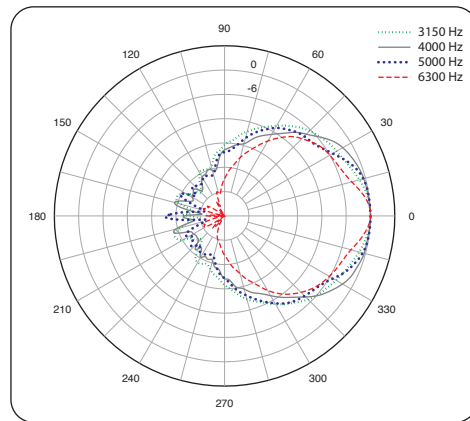
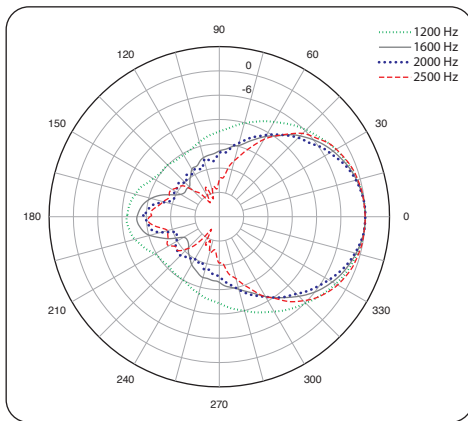
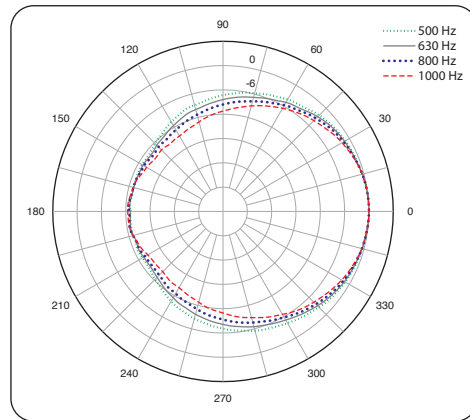
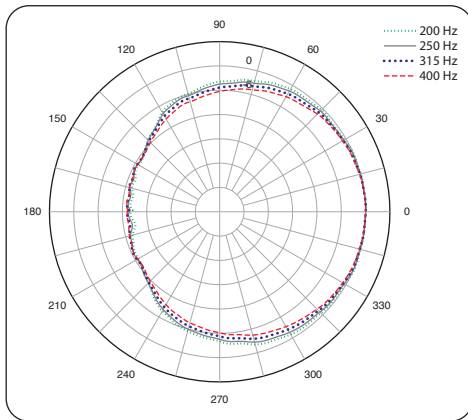

Touring Speakers

# FLASHLINE MONITOR TFM152M

Co-axial 2 Way 15" Stage Monitor for  
Touring Applications

## Vertical Polar Plots

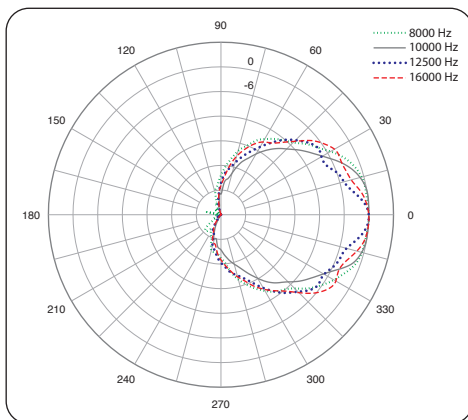
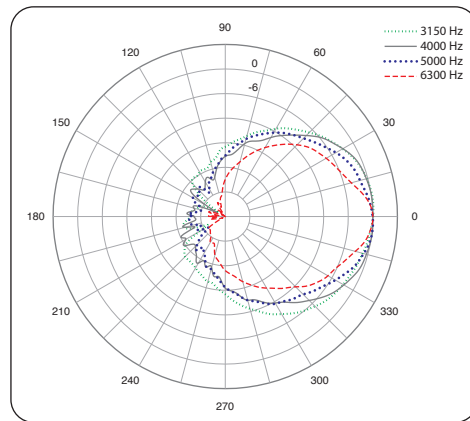
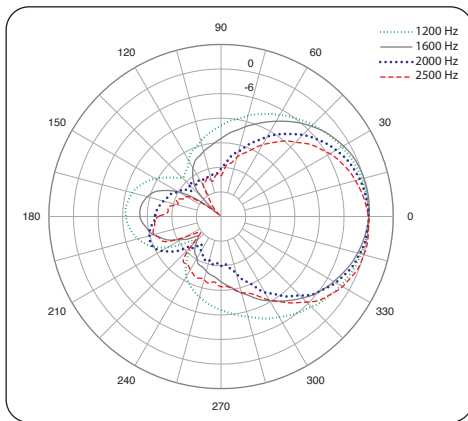
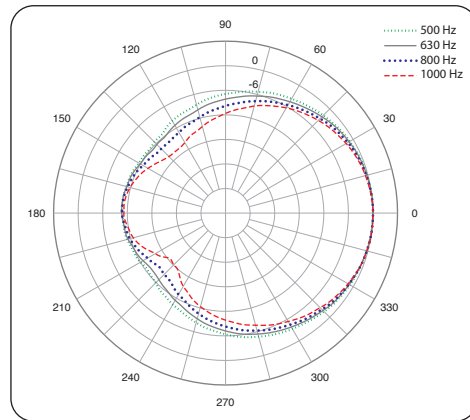
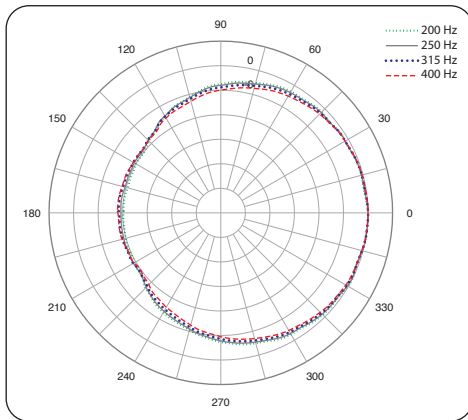

Touring Speakers

# FLASHLINE MONITOR TFM152M

Co-axial 2 Way 15" Stage Monitor for  
Touring Applications

## Dimensions

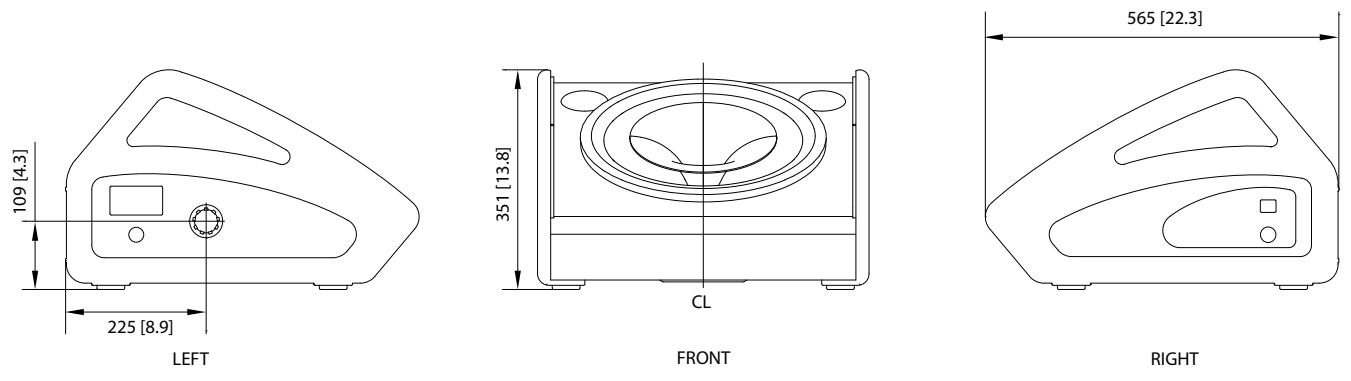
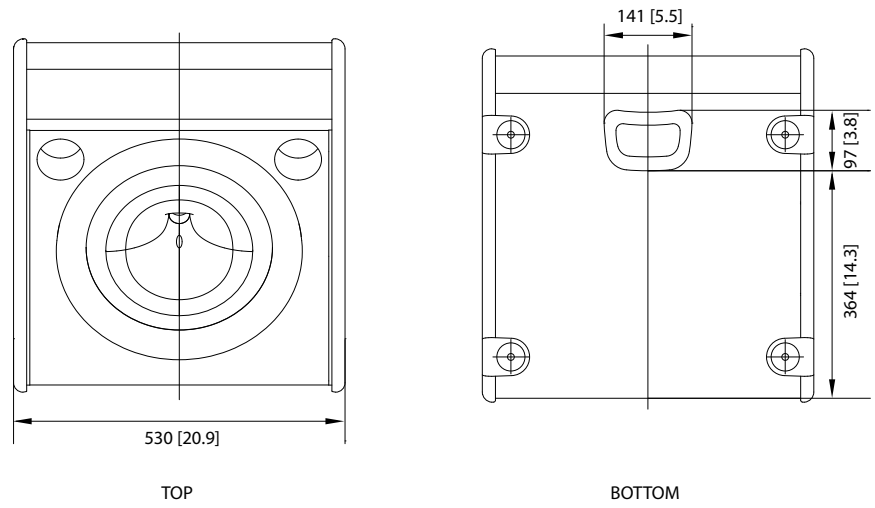

## Touring Speakers

# FLASHLINE MONITOR TFM152M

Co-axial 2 Way 15" Stage Monitor for  
Touring Applications

## Technical Specifications

### System

<b>Frequency Response</b>	65 Hz – 18 kHz $\pm 3$ dB 50 Hz – 20 kHz -10 dB
<b>Nominal Dispersion</b>	60° H x 40° V @ -6 dB points, rotatable
<b>Directivity Factor (Q)</b>	18.3
<b>Directivity Index (DI)</b>	12.6
<b>Power Handling (IEC)</b>	
Passive	350 W continuous, 1,400 W peak
Bi-amp	LF: 310 W continuous, 1,240 W peak HF: 40 W Continuous, 160 W peak
<b>Sensitivity</b>	96 dB (1 W @ 1 m)
<b>Maximum SPL</b>	
Passive	124 dB continuous, 130 dB peak
Bi-Amp	LF: 123 dB continuous, 129 dB peak HF: 123 dB continuous, 129 dB peak
<b>Impedance</b>	
Passive	8 $\Omega$
Bi-Amp	LF: 8 $\Omega$ HF: 8 $\Omega$
<b>Crossover Type</b>	Passive / bi-amp, switchable
<b>Components</b>	1 x 15" (393.5 mm) LF driver 1 x 1.4" (33 mm) HF compression driver

### Enclosure

<b>Connectors</b>	2 x Neutrik speakON NL4,
<b>Wiring</b>	
Passive	Pins 1+ / 1- input, pins 2+ / 2- link
Bi-Amp	Pins 1+ / 1- LF, pins 2+ / 2- HF
<b>Dimensions (H x W x D)</b>	351 x 530 x 565 mm (13.8 x 20.9 x 22.3")
<b>Net Weight</b>	19.4 kg (42.7 lbs)
<b>Construction</b>	15 mm (5/8") birch plywood + Polypropylene plastic
<b>Finish</b>	Semi matt black paint
<b>Grille</b>	Powder coated perforated steel
<b>Flying Hardware</b>	N/A



Touring Speakers

# FLASHLINE MONITOR

## TFM152M

Co-axial 2 Way 15" Stage Monitor for  
Touring Applications



Touring Speakers

# FLASHLINE MONITOR TFM152M

Co-axial 2 Way 15" Stage Monitor for  
Touring Applications



Touring Speakers

# FLASHLINE MONITOR TFM152M

Co-axial 2 Way 15" Stage Monitor for  
Touring Applications



Touring Speakers

# FLASHLINE MONITOR

## TFM152M

Co-axial 2 Way 15" Stage Monitor for  
Touring Applications



For service, support or more information contact the TURBOSOUND location nearest you:

**Europe**  
**MUSIC Group Services UK**  
Tel: +44 156 273 2290  
Email: CARE@music-group.com

**USA/Canada**  
**MUSIC Group Services NV Inc.**  
Tel: +1 702 800 8290  
Email: CARE@music-group.com

**Japan**  
**MUSIC Group Services JP K.K.**  
Tel: +81 3 6231 0454  
Email: CARE@music-group.com

MUSIC Group accepts no liability for any loss which may be suffered by any person who relies either wholly or in part upon any description, photograph, or statement contained herein. Technical specifications, appearances and other information are subject to change without notice. All trademarks are the property of their respective owners. MIDAS, KLARK TEKNIK, LAB GRUPPEN, LAKE, TANNÖY, TURBOSOUND, TC ELECTRONIC, TC HELICON, BEHRINGER, BUGERA and DDA are trademarks or registered trademarks of MUSIC Group IP Ltd.  
© MUSIC Group IP Ltd. 2016 All rights reserved.

