

Install Speakers

DUBLIN TCX122-WH

2 Way 12" Loudspeaker for Portable PA and Installation Applications (White)

- 2 way loudspeaker for portable PA and installation applications
- 300 Watts continuous, 1,200 Watts peak power
- High excursion 12" low frequency driver with low mass voice coil for improved transient response
- 1" high temperature dome compression driver with extended high frequency reproduction
- Rotatable converging elliptical waveguide provides 90° H x 60° V dispersion
- M10, M8 and M6 rigging points compatible with TURBOSOUND and OmniMount* brackets
- Trapezoidal cabinet shape enables visually unobtrusive loudspeaker arrays
- Concealed pole mount socket enables mobile applications
- Integral handle for lifting and carrying
- 15 mm (5/8") birch plywood enclosure with hard wearing semi matt white paint finish
- Powder coated perforated steel mesh grille with foam backing
- Neutrik speakON* NL4 and barrier strip connectors
- 3-Year Warranty Program*
- Designed and engineered in England

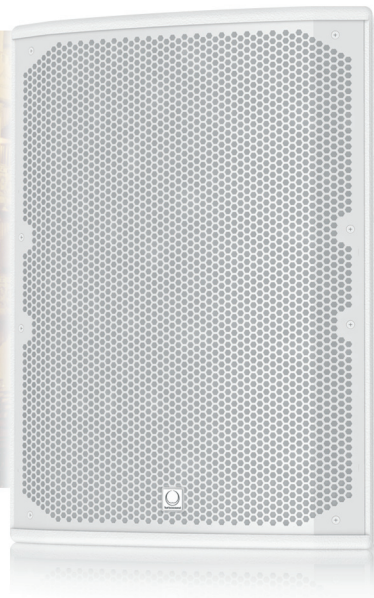

The DUBLIN TCX122-WH is a 1200 Watt compact 12" passive two way loudspeaker that is ideally suited for a wide range of portable or installed speech and music sound reinforcement applications. TCX122-WH consists of a trapezoidal enclosure housing a high excursion 12" reflex-loaded low frequency driver with low mass voice coil for improved transient response, and a 1" high temperature dome compression driver mounted on a rotatable converging elliptical waveguide, which provides a 90° horizontal by 60° vertical dispersion pattern.



Custom-Engineered Drivers

TURBOSOUND is recognised the world over for designing and building some of the most iconic loudspeakers and subwoofers. We take meticulous care and pride in maintaining that reputation by utilising only drivers designed specifically for each application – it's what sets us apart from the competition. TCX122-WH's high excursion 12" low frequency and 1" high temperature dome compression drivers ensure truly world-class performance that will stand the test of time.

Install Speakers

DUBLIN TCX122-WH

2 Way 12" Loudspeaker for Portable PA and Installation Applications (White)

Rotatable Waveguide

The TCX122-WH's compression driver is mated to a converging elliptical waveguide that is rotatable through 90°, allowing a swap of the horizontal and vertical dispersion patterns for a smooth wavefront, while providing exceptional pattern control. This feature is especially useful for retaining wide horizontal dispersion when the enclosure is mounted horizontally due to ceiling height restrictions.



Construction and Connectivity

Constructed from 15 mm (5/8") birch plywood, the cabinet is finished in hard wearing semi matt white textured paint and includes internal M10, M8 and M6 threaded rigging points for use with [TURBOSOUND](#) and industry standard wall and ceiling brackets. A perforated steel mesh grille backed with reticulated foam protects the drive units. The rear connector panel provides two Neutrik speakON* NL4 connectors for input and link functions, which are wired in parallel to a 4-way barrier strip connector.

Discreet Implementation

When permanently installed, the TCX122-WH presents a discreet appearance with no visible side handles for visually unobtrusive loudspeaker arrays, while in portable applications the pole mount blanking plug can be removed for use with speaker stands or poles. A single carrying handle is provided for ease of installation and transportation.



Install Speakers

DUBLIN TCX122-WH

2 Way 12" Loudspeaker for Portable PA and
Installation Applications (White)



You Are Covered

We always strive to provide the best possible Customer Experience. Our products are made in our own [MUSIC Group](#) factory using state-of-the-art automation, enhanced production workflows and quality assurance labs with the most sophisticated test equipment available in the world. As a result, we have one of the lowest product failure rates in the industry, and we confidently back it up with a generous [3-Year Warranty program](#).

Install Speakers

DUBLIN

TCX122-WH

2 Way 12" Loudspeaker for Portable PA and Installation Applications (White)

Frequency Response Sensitivity 1 W / 1 m

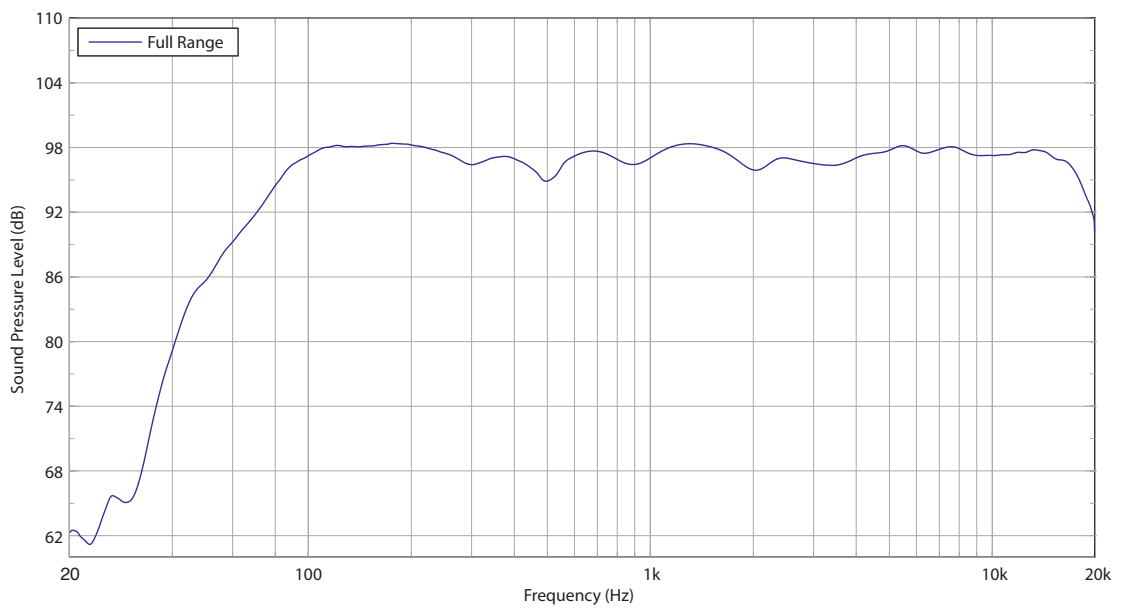

Impedance

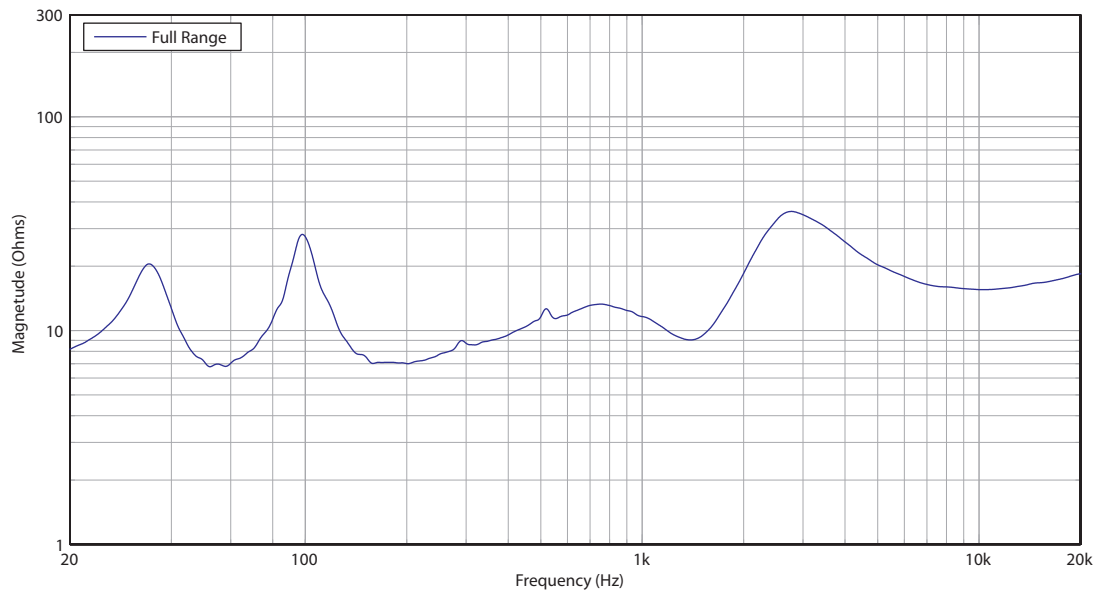

Install Speakers

DUBLIN

TCX122-WH

2 Way 12" Loudspeaker for Portable PA and Installation Applications (White)

Horizontal Beamwidth

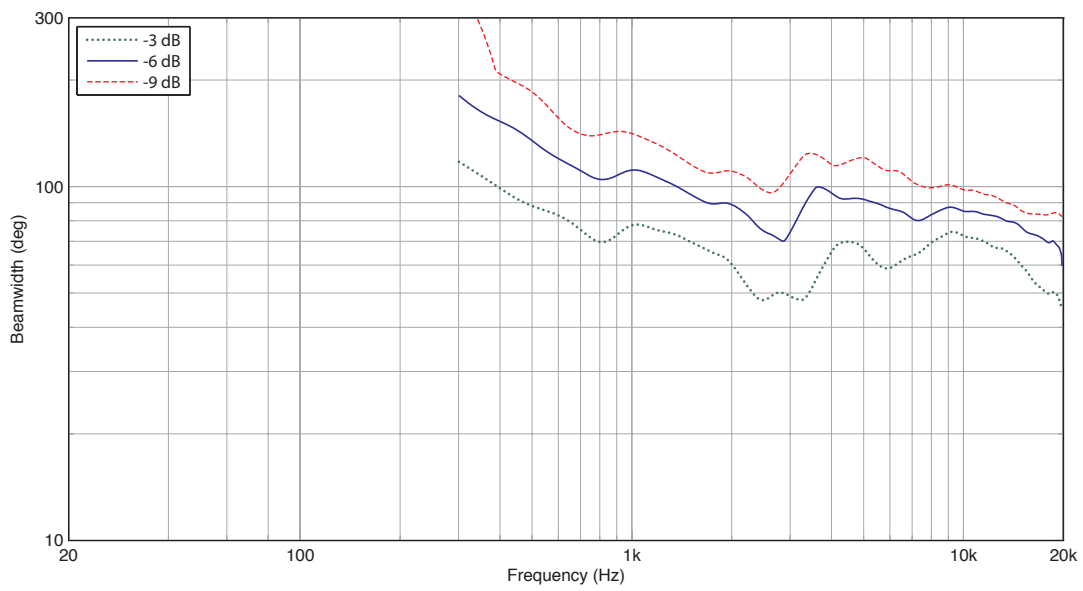

Vertical Beamwidth

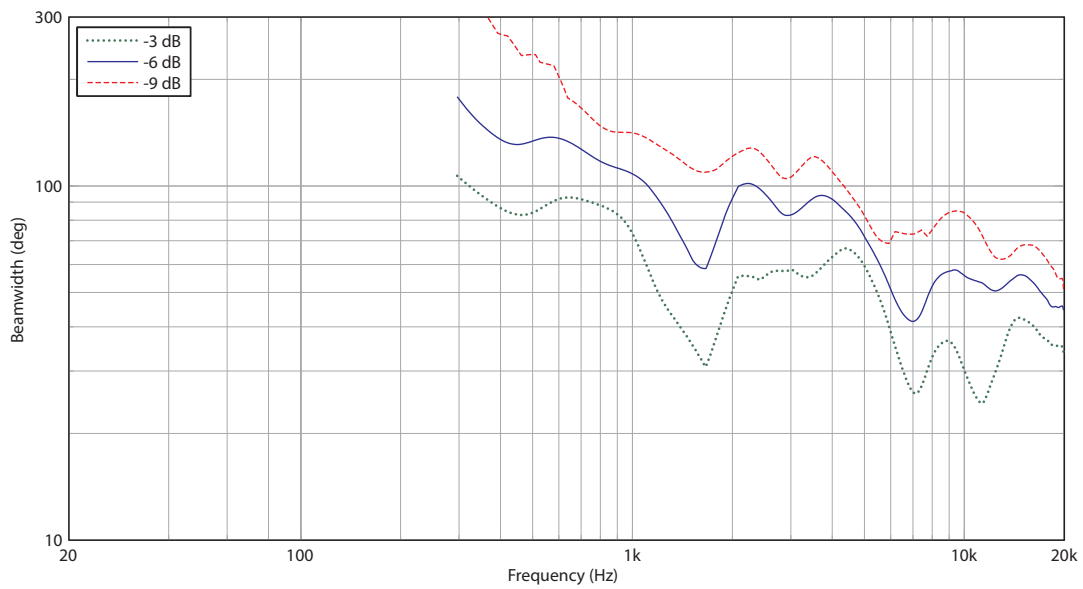

Install Speakers

DUBLIN TCX122-WH

2 Way 12" Loudspeaker for Portable PA and Installation Applications (White)

Horizontal Polar Plots

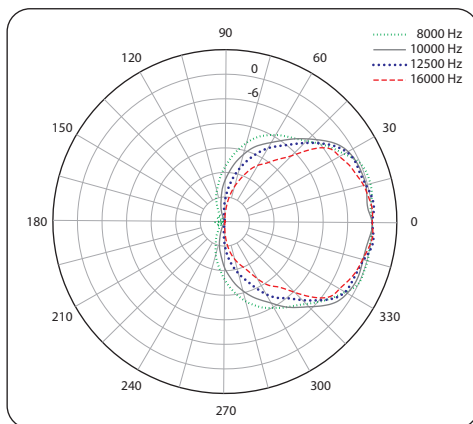
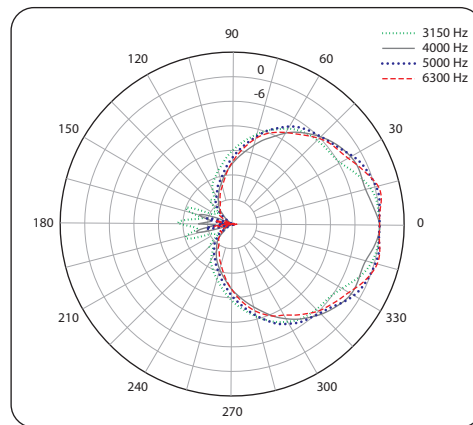
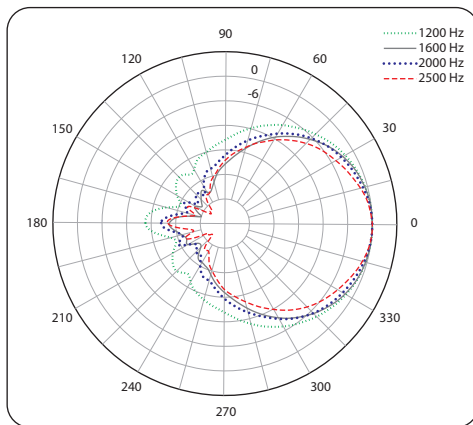
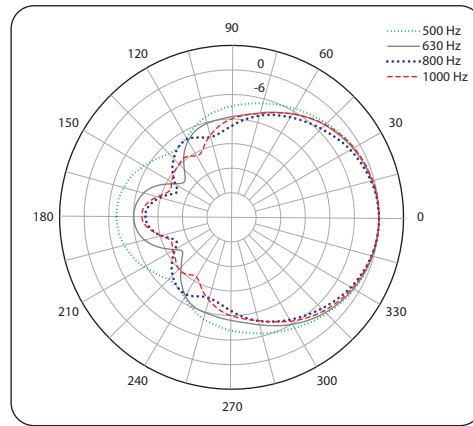
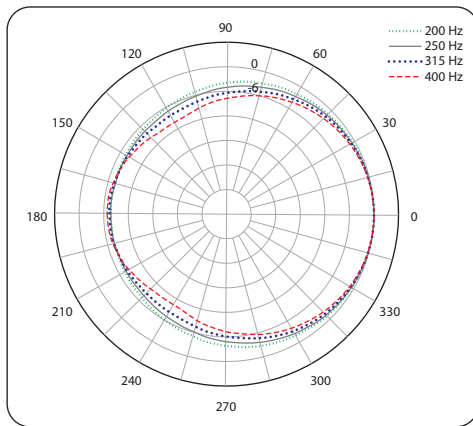

Install Speakers

DUBLIN TCX122-WH

2 Way 12" Loudspeaker for Portable PA and Installation Applications (White)

Vertical Polar Plots

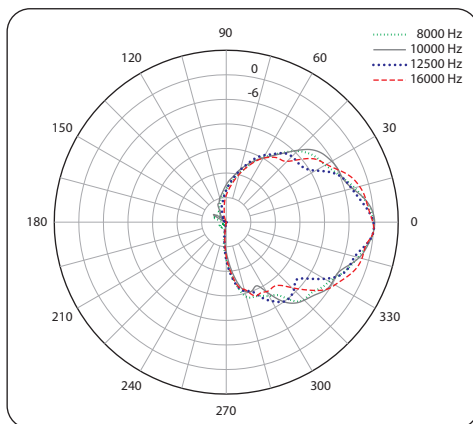
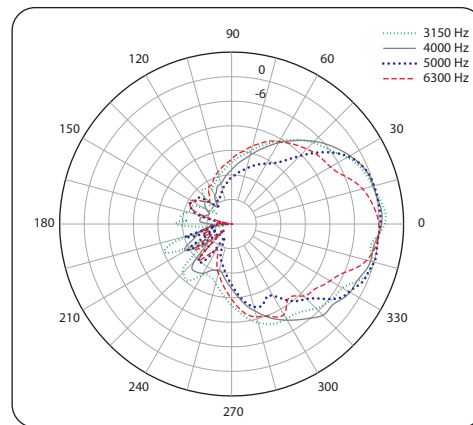
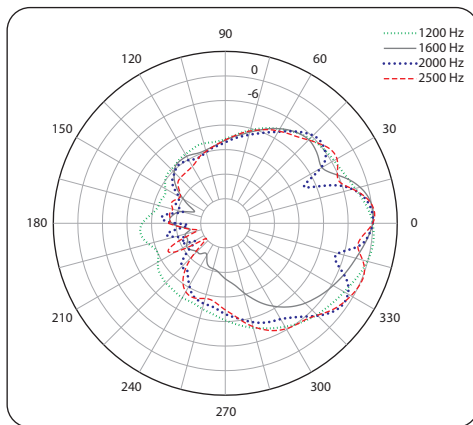
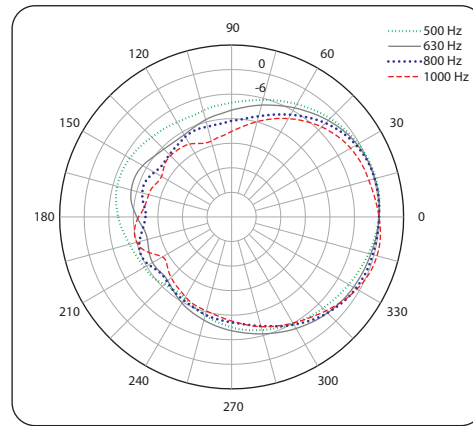
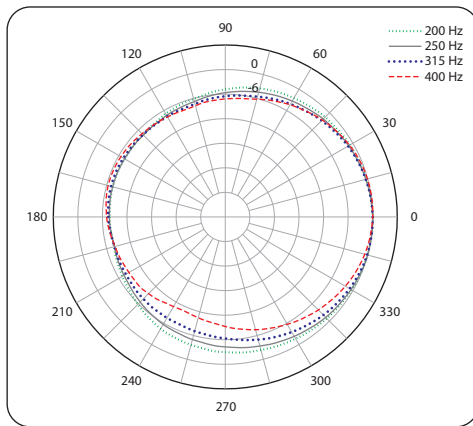

Install Speakers

DUBLIN TCX122-WH

2 Way 12" Loudspeaker for Portable PA and Installation Applications (White)

Dimensions

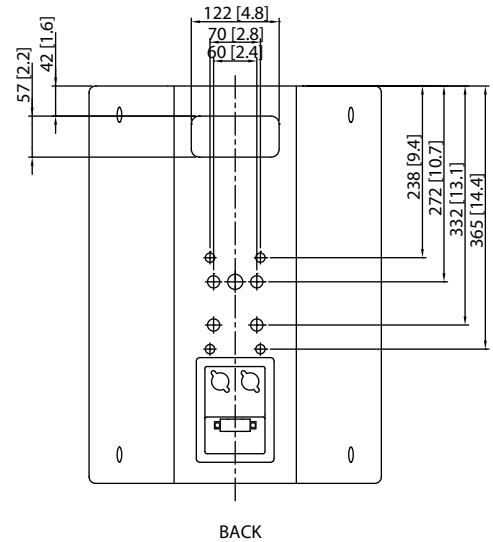
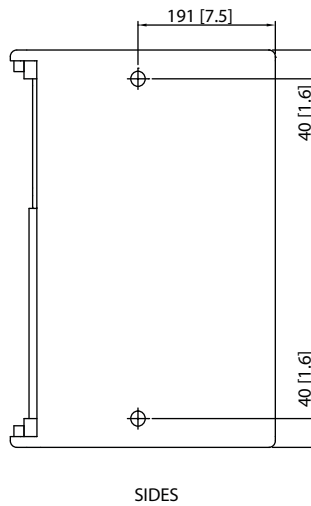
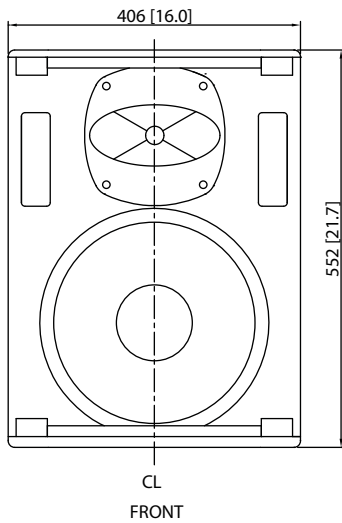
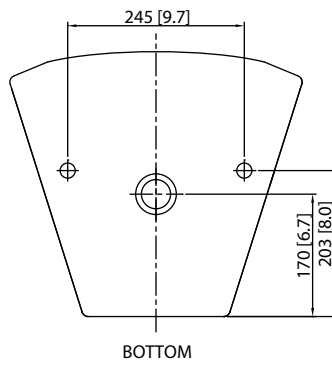
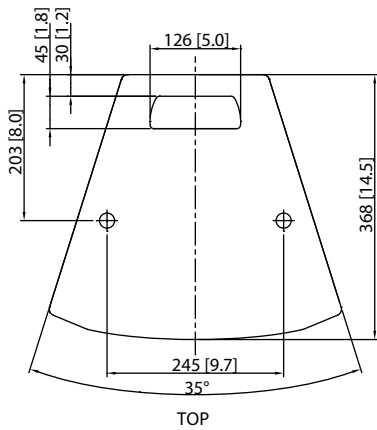

Install Speakers

DUBLIN TCX122-WH

2 Way 12" Loudspeaker for Portable PA and
Installation Applications (White)

Mounting and Rigging

The cabinet is fitted with M6 x 4, M8 x 4 and M10 x 9 internally-threaded rigging points that allow it to be rigged with optional shoulder eyebolts and mounted in many different configurations in permanent installations. The simplest method of rigging is to use two rigging points on the top, and a single pull-back rigging point on the rear panel. Adjustment of the length of the rear cable allows the cabinet to be angled for optimum room coverage. Cabinets may also be hung upside down if required. The horn of each cabinet may be rotated through 90 degrees to optimise the coverage.

The cabinet is compatible with industry standard wall and ceiling brackets.

The cabinet has a standard pole mount receptacle that allows it to be used with an industry standard speaker pole on top of a TCX115B or TCX118B bass cabinet. A removable plastic bung covers the pole mount socket.

Install Speakers

DUBLIN

TCX122-WH

2 Way 12" Loudspeaker for Portable PA and Installation Applications (White)

Technical Specifications

System

Frequency response	100 Hz - 18 kHz \pm 3 dB 68 Hz - 20 kHz -10 dB
Nominal dispersion	90° H x 60° V @ -6 dB points
Power handling (IEC)	300 W continuous, 1,200 W peak
Sensitivity	97 dB (1 W @ 1 m)
Maximum SPL	122 dB continuous, 128 dB peak
Impedance	8 Ω
Components	1 x 12" (305 mm) LF driver 1 x 1" (25 mm) HF compression driver

Enclosure

Connectors	2 x Neutrik speakON* NL4, 1 x barrier strip terminals
Wiring	Pins 1+ / 1- input, pins 2+ / 2- link
Dimensions HWD	552 x 406 x 368 mm (21.7 x 16.0 x 14.5")
Net weight	18.3 kg (40.2 lbs)
Construction	15 mm (5/8") birch plywood
Finish	Semi matt white paint (black optional)
Grille	Powder coated perforated steel
Flying hardware	M10 x 9, M8 x 4, M6 x 4 Points

Install Speakers

DUBLIN

TCX122-WH

2 Way 12" Loudspeaker for Portable PA and
Installation Applications (White)

Architecture & Engineering Specifications

The loudspeaker shall be of the full range, two-way passive type consisting of one 12" (305 mm) LF driver and one 1" (25 mm) HF compression driver. Performance specifications of a typical production unit shall meet or exceed the following: frequency response, measured with swept sine wave input, shall be flat within ± 3 dB from 100 Hz to 18 kHz and within -10 dB from 68 Hz to 20 kHz. Nominal dispersion, at -6 dB points, shall average 90° H x 60° V, rotatable. Nominal impedance shall be 8 Ohms. Power handling shall be 300 Watts continuous, 1200 Watts peak. Sensitivity, measured on axis, mean averaged over stated bandwidth, shall be 97 dB, 1 Watt @ 1 metre. Maximum SPL (peak), measured at 1 metre with music program at stated amplifier input, shall be 128 dB. Dimensions: 552 mm high x 406 mm wide x 368 mm deep (21.7" x 16.0" x 14.5"). Net weight: 18.3 kg (40.2 lbs). The loudspeaker system shall be the [TURBOSOUND TCX122-WH](#). No other loudspeaker shall be acceptable unless submitted data from an independent test laboratory verifies that the above combined performance / size specifications are equalled or exceeded.

Install Speakers

DUBLIN TCX122-WH

2 Way 12" Loudspeaker for Portable PA and
Installation Applications (White)



Install Speakers

DUBLIN TCX122-WH

2 Way 12" Loudspeaker for Portable PA and
Installation Applications (White)

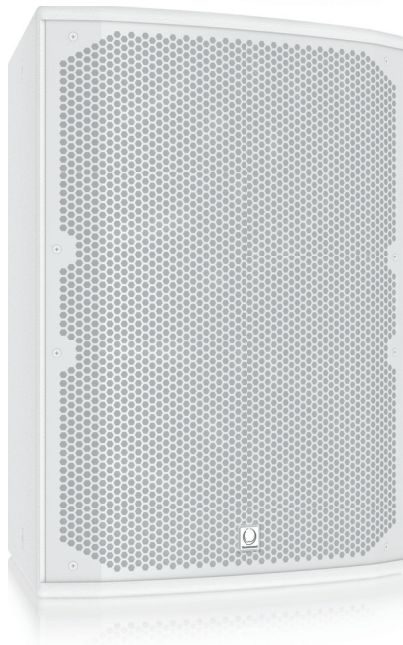
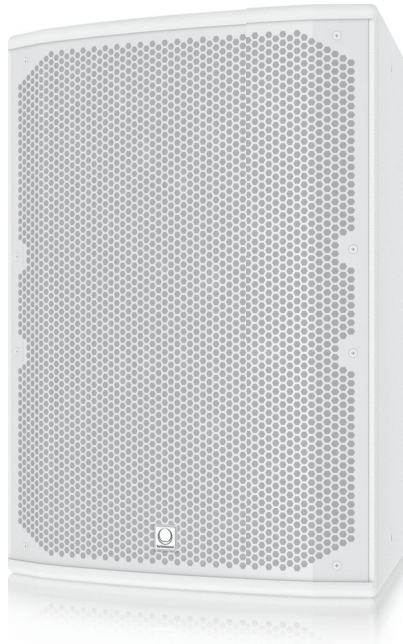

Install Speakers

DUBLIN

TCX122-WH

2 Way 12" Loudspeaker for Portable PA and Installation Applications (White)



TCX122	
WIRING	PASSIVE
1+ / 1-	INPUT 8 Ω
2+ / 2-	LINK



For service, support or more information contact the TURBOSOUND location nearest you:

Europe
MUSIC Group Services UK
Tel: +44 156 273 2290
Email: CARE@music-group.com

USA/Canada
MUSIC Group Services NV Inc.
Tel: +1 702 800 8290
Email: CARE@music-group.com

Japan
MUSIC Group Services JP K.K.
Tel: +81 3 6231 0454
Email: CARE@music-group.com

MUSIC Group accepts no liability for any loss which may be suffered by any person who relies either wholly or in part upon any description, photograph, or statement contained herein. Technical specifications, appearances and other information are subject to change without notice. All trademarks are the property of their respective owners. MIDAS, KLARK TEKNIK, LAB GRUPPEN, LAKE, TANNOY, TURBOSOUND, TC ELECTRONIC, TC HELICON, BEHRINGER, BUGERA and DDA are trademarks or registered trademarks of MUSIC Group IP Ltd.
© MUSIC Group IP Ltd. 2016 All rights reserved.

