



## GENERAL INFORMATION

Having the lights on in an already well-lit area means wasted energy and bigger electrical bills. Echo Light Sensors are the sensible way to lower energy expenditures and meet energy codes. Light Sensors have a neutral look that easily blends into their surroundings. The sensors are ready to go in their standard form, or you can detach the sensor's RemoLux head to use as a remote sensor. It is perfect for atriums and other spaces with high ceilings. The Light Sensor can also be installed indoors or outdoors.

### APPLICATIONS

- Houses of worship
- Education
- Hospitality
- Healthcare facilities
- Office buildings
- Conference rooms
- Meeting rooms
- Retail

### FEATURES

- Sensor Controller with or without integrated Light Sensor
- RemoLux: Light Sensor can be mounted within controller housing or remotely
  - Remote sensors connect using Belden 8471 or two #16AWG wires
  - Filler included for remote-head applications
- DualLux: Supports up to two sensors to average light levels in large areas
- Single Light Sensor for indoor, outdoor and atrium use
- Configurable to activate or deactivate any Echo controller
- EchoConnect: two-wire, topology-free bus for power and communication
- Each sensor counts as one station with up to two light heads
- Available in white and black
- Supports switched and dimming daylight harvesting
- Two-zone daylighting control from a single sensor
- Multi Space Preset functionality

### REGULATORY AND COMPLIANCE

- UL and cUL LISTED
- CE certified
- Compliant with California Title 24 when properly installed and configured

## ORDERING INFORMATION

### Echo Light Sensor

MODEL	DESCRIPTION
ELS	Echo Light Sensor with Controller
ELSC	Echo Light Sensor Controller Only
ELSH	Echo Light Sensor Head Only

**Note:** Sensors come standard in pure white (RAL9010). Add -4 to the end of any model number for black (RAL9004)

### Echo Power Requirements

EchoConnect:	One unit of control power
Auxiliary Power:	Not required



## SPECIFICATIONS

**FUNCTIONAL**

- Configurable on and off set points
- Performs space raise and lower for controllers configured to the same space
- Configurable delay/offset
- Light Sensor can be mounted within controller housing or remotely; filler included for remote head applications
- Support for up to two sensors with averaging of light levels
- Single Light Sensor for indoor, outdoor and atrium use

**MECHANICAL**

- Constructed of injection-molded, ABS plastic in Pure White (RAL9010) or Black (RAL 9004)
- Electronics assembly and mounting plate included
- Two cantilevered configuration buttons
- No visible means of attachment
- Surface or box mountable using included mounting plate
  - Supports drywall, plaster, wood, and concrete mounting
  - Mounts to any standard electrical box (supplied by others)
  - Mounts to compressed-fiber ceilings using wire-form adapter
- Supports internal or remote mounting of light sensor
  - Remote light head mounts to any 1/2" or 3/4" knockout
- Remote Heads use conformal-coated circuit boards resistant to corrosion from moisture
  - IP65 rated when used with a weather-tight backbox

**ELECTRICAL**

- Controller connects via EchoConnect control network utilizing low-voltage Class 2 wiring
  - Topology-free and polarity-independent wiring over Belden 8471 or equivalent and one #14 ESD drain wire
  - Wiring may be bus, loop, homerun or any combination of these
- Up to 500 meters (1640 feet) of control wiring per system
- Supports optional Cat5/5e wiring using Belden 1583A or equivalent
  - Requires optional Cat5 termination accessories
- Remote sensors connect using two #16AWG wires up to 1000' away from controller

**ENVIRONMENTAL**

- Ambient room temperature: -30 to 55°C / -22 to 130°F
- Ambient humidity: Maximum 90% non-condensing

## FUNCTIONALITY

**BASIC MODE FUNCTIONALITY**

- Above Target Lux Event: Space Lower
- Below Target Lux Event: Space Raise

**CUSTOM MODE FUNCTIONALITY**

(Requires Programming With EchoAccess Mobile App and additional connection hardware)

- Switched Mode Bright Events Supported:
  - Preset Activate\*
  - Zone Set to Level
  - Space Off\*
  - Space Set to Level
- Switched Mode Dark Events Supported:
  - Preset Activate\*
  - Zone Set to Level
  - Space Off\*
  - Space Set to Level
- Dimmed Mode Space Control:
  - Space Raise
  - Space Lower
- Dimmed Mode Single Zone Control:
  - Zone Raise
  - Zone Lower
- Dimmed Mode Dual Zone Control:
  - Zone 1 Raise
  - Zone 1 Lower
  - Zone 2 Percentage Raise
  - Zone 2 Percentage Lower

\*Multi Space capable - allowing for presets to be recalled in multiple spaces from a single control

## ECHO FAMILY OF PRODUCTS

## EchoConnect Power Supplies

MODEL	DESCRIPTION
E-SPS	6U Room Station Power Supply, Knockout Mount
E-SPS-DIN	16U DIN rail Station Power Supply with 24V Aux
E-SPM	16U DRd Station Power Module
E-SPM-A	16U DRd Station Power Module with 24V Aux
E-SPM-RM	16U Rack-Mount Station Power Module Aux
E-SPM-RM-A	16U Rack-Mount Station Power Module 24V Aux
E-SPM-WM	16U Wall-Mount Station Power Module
E-SPM-WM-A	16U Wall-Mount Station Power Module 24V Aux
E-APS	24V Aux Power Supply, Knockout Mount

## EchoTouch

MODEL	DESCRIPTION
ETS	EchoTouch Controller

## Echo Stations

MODEL	DESCRIPTION
E1001	Inspire One Button Station
E1002	Inspire Two Button Station
E1004	Inspire Four Button Station
E1006	Inspire Six Button Station
E1008	Inspire Eight Button Station
E1104	Inspire Four Button with Fader Station
EPS05	Echo Preset Station - 5 Button
EPS10	Echo Preset Station - 10 Button
EPSLO	Echo Lockout Station
E-ATC	Echo TimeClock

## Echo Responsive Controls

MODEL	DESCRIPTION
ELS	Light Sensor
EOCC	Ceiling-Mount PIR Occupancy Sensor
EVAC	Ceiling-Mount PIR Vacancy Sensor
E-DOC-C	Ceiling-Mount Dual Tech Occupancy Sensor
E-DVAC-C	Ceiling-Mount Dual Tech Vacancy Sensor
E-DOC-W	Wall-Mount Dual Tech Occupancy Sensor
E-DVAC-W	Wall-Mount Dual Tech Vacancy Sensor
E-DOC-SM1	Switch-Mount Dual Tech Sensor - One Button
E-DOC-SM2	Switch-Mount Dual Tech Sensor - Two Button

## Echo Interfaces

MODEL	DESCRIPTION
EACC	EchoAccess Interface
EEB	Echo Expansion Bridge
EDMXC	Echo DMX Scene Controller
EEL	Echo-Echoflex Interface
ECII	Echo Contact Input Interface
ECOI	Echo Contact Output Interface
EDRI	Echo Demand Response Interface
EBI	Echo BACnet Interface

## Zone Controllers

MODEL	DESCRIPTION
ERC-G2	One Zone Relay Controller
EDRC-G2	Two Zone Relay Controller
ELD-G2	One Zone 0-10V Controller
EDLD-G2	Two Zone 0-10V Controller
ESSC-G2	One Zone SmartSpace Controller
EDSSC-G2	Two Zone SmartSpace Controller
ELVD-G2	600-Watt Phase Adaptive Dimmer
ELVD-277-G2	600-Watt Phase Adaptive Dimmer- 277V

## Room Controllers

MODEL	DESCRIPTION
ERMCT4-G2	Four Zone Room Controller
ERMCT4-G2	Four Zone Room Controller with TimeClock
ERMCT8-G2	Eight Zone Room Controller
ERMCT8-G2	Eight Zone Room Controller with TimeClock

## Panel Products

MODEL	DESCRIPTION
ERP	Echo Relay Panel Mains Feed
ERP-FT	Echo Relay Panel Feed Through
SensorIQ	Sensor IQ Intelligent Breaker System
SR3	Sensor3 Power Control System
DRd	Unison DRd with Echo Control

SAMPLE ECHO SYSTEMS

SMALL SYSTEM

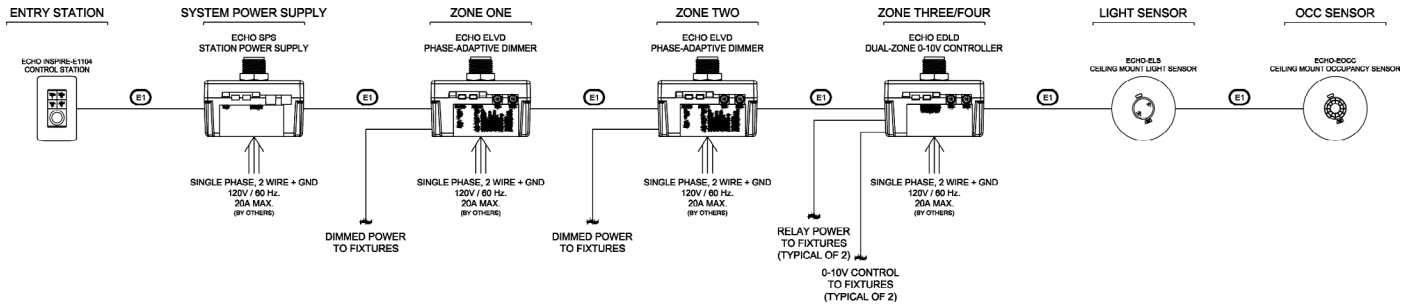

MEDIUM SYSTEM

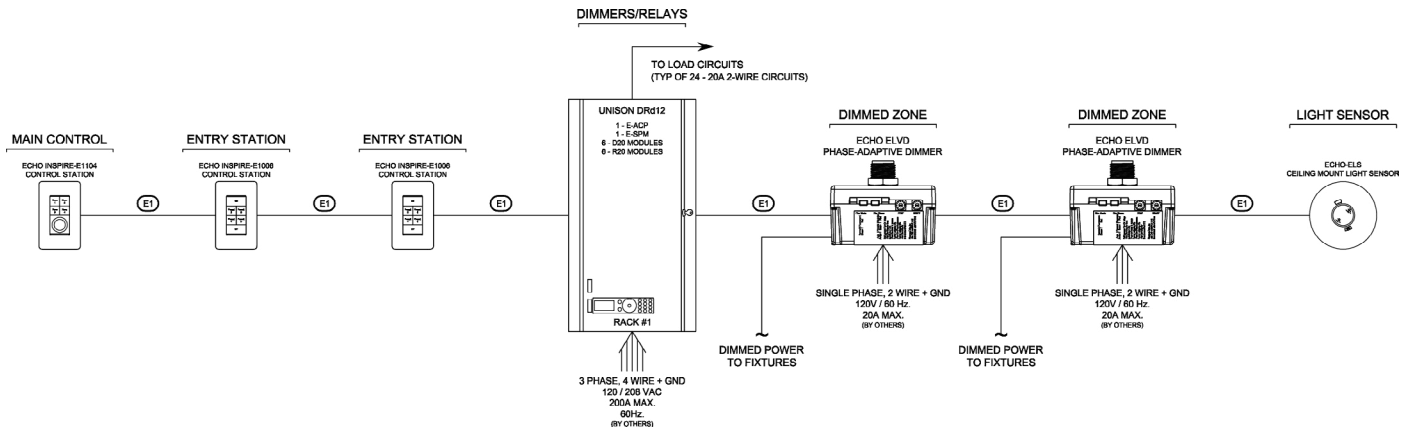

CONFERENCE ROOM

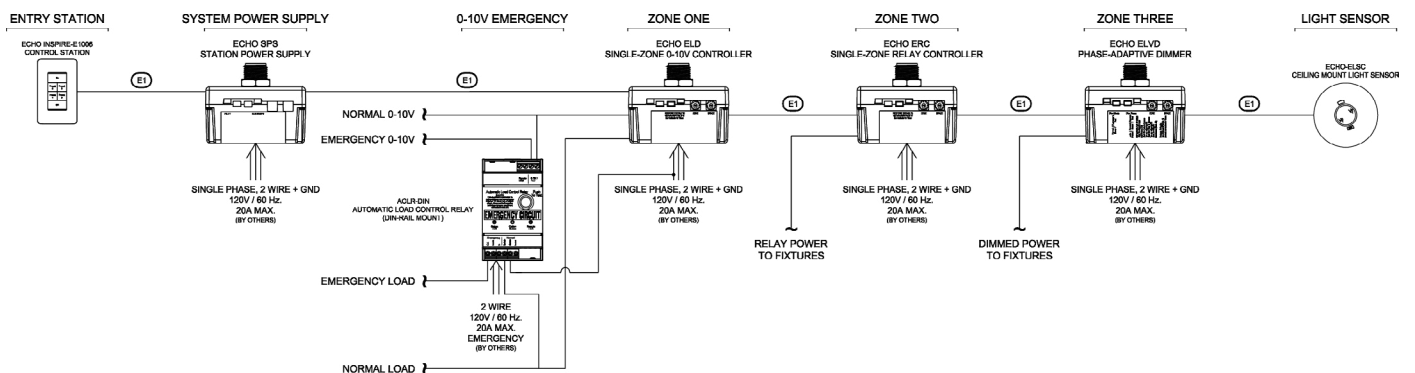

SAMPLE ECHO SYSTEMS

MEDIUM BALLROOM

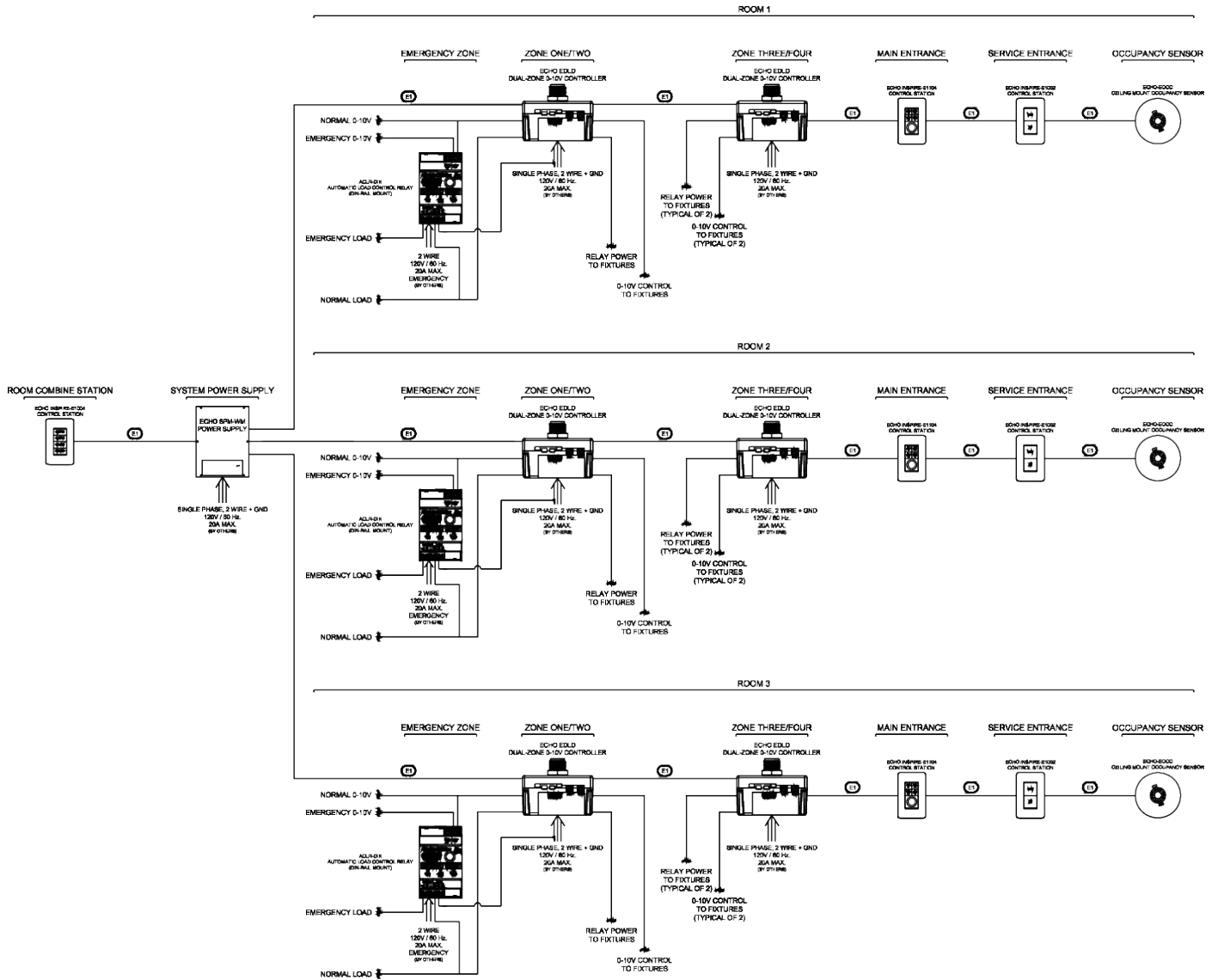

PHYSICAL

Light Sensor Dimensions\*

MODEL	DIAMETER		DEPTH	
	in	mm	in	mm
ELS/ ELSC	4.50	114	1.40	36
ELSH	1.60	41	0.66	17

Light Sensor Weights\*

MODEL	WEIGHT		SHIPPING WEIGHT	
	oz	g	oz	g
ELS	3	76.5	9	255.1
ELSC	3	76.5	9	235.3
ELSH	1	28.3	7	178.6

\*Weights and dimensions typical

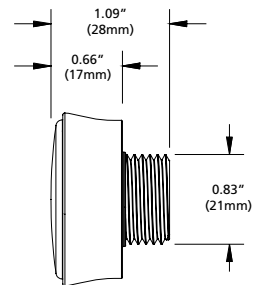
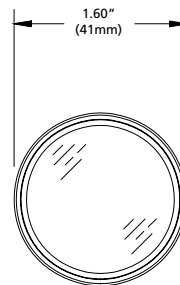
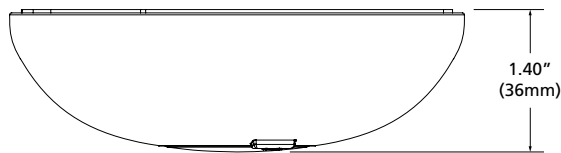

SHOWN WITHOUT INCLUDED THREADED EXTENDER

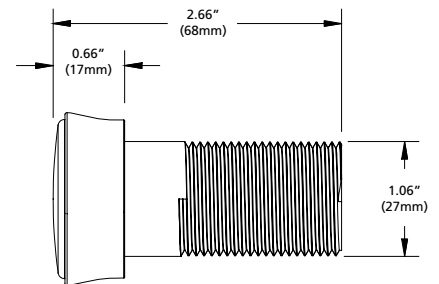
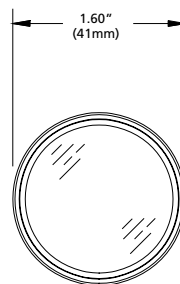
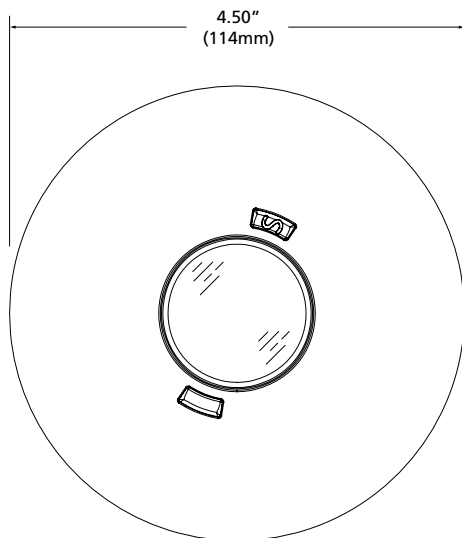

SHOWN WITH INCLUDED THREADED EXTENDER



Corporate Headquarters • Middleton, WI USA

Global Offices • London, UK • Rome, IT • Holzkirchen, DE • Paris, FR • Hong Kong • Singapore • New York, NY • Orlando, FL • Los Angeles, CA

Copyright©2019 ETC. All Rights Reserved. All product information and specifications subject to change. Rev J 05/19

Trademark and patent info: etconnect.com/VP

etconnect.com