

OBERON



Profile

NZ / WZ



Blizzard Lighting, LLC
www.blizzardlighting.com
Waukesha, WI USA
Copyright (c) 2016

TABLE OF CONTENTS

Oberon™ Profile	1
1. Getting Started	3
What's In The Box?	3
Getting It Out Of The Box	3
Powering Up!	3
Getting A Hold Of Us	3
Safety Instructions (Don't Stick Your Hand In The Toaster!)	4
2. Meet The Oberon™ Profile	5
Features	5
DMX Values In-Depth	5
The Oberon™ Profile Pin-up Picture	6
3. Setup	7
Fuse Replacement	7
Connecting A Bunch Of Oberon™ Profile Fixtures	7
Data/DMX Cables	7
Cable Connectors	8
3-Pin??? 5-Pin??? Huh?	8
Take It To The Next Level: Setting up DMX Control	8
Connection With Mains	9
Mounting/Rigging	9
Gobo Holder	9
Color Gel Frame	9
4. Operating Adjustments	10
The Control Panel	10
Control Panel Menu Structure	11
DMX Mode	11
Setting the DMX Address	11
Select the DMX Channel Mode	11
Master/Slave Setting	11
Perform Function (Demo)	11
Manual Dimmer	11
Zoom and Focus	11
5. Appendix	12
A Quick Lesson On DMX	12
Troubleshooting	12
Keeping Your Oberon™ Profile As Good As New	13
Returns (Gasp!)	13
Shipping Issues	13
Tech Specs	14
Dimensional Drawings	14
Photometric Data	15

1. GETTING STARTED

What's In The Box?

- 1 x Oberon™ Profile NZ or WZ
- 1 x Color Gel Frame
- 1 x Gobo Holder
- 1 x Ever-So-Handy Power Cord
- 1 x Really Classy DMX Cable
- This Lovely User Manual

Getting It Out Of The Box

Félicitations mon ami! You've got yourself one fantastic professional ellipsoidal LED lumière. Now that you've got your Oberon™ Profile (or hopefully, *Profiles!*), you should carefully unpack the box and check the contents to ensure that all parts are present and in good condition. If anything looks as if it has been damaged in transit, notify the shipper immediately and keep the packing material for inspection. Again, please save the carton and all packing materials. If a fixture must be returned to the factory, it's important that it be returned in the original factory box and packing.

Powering Up!

All fixtures must be powered directly off a switched circuit and **cannot be run off a rheostat (variable resistor) or dimmer circuit, even if the rheostat or dimmer channel is used solely for a 0% to 100% switch.**

AC Voltage Switch - Not all fixtures have a voltage select switch, so please verify that the fixture you receive is suitable for your local power supply. See the label on the fixture or refer to the fixture's specifications chart for more information. A fixture's listed current rating is its average current draw under normal conditions. Check the fixture or device carefully to make sure that if a voltage selection switch exists that it is set to the correct line voltage you will use.

Warning! Verify that the voltage select switch on your unit matches the line voltage applied. Damage to your fixture may result if the line voltage applied does not match the voltage indicated on the voltage selector switch. All fixtures must be connected to circuits with a suitable Ground (Earthing).

Getting A Hold Of Us

If something is wrong, please open a support ticket on our website at www.blizzardlighting.com/support. We'll be happy to help, honest.

Disclaimer: The information and specifications contained in this document are subject to change without notice. Blizzard Lighting™ assumes no responsibility or liability for any errors or omissions that may appear in this user manual. Blizzard Lighting™ reserves the right to update the existing document or to create a new document to correct any errors or omissions at any time. You can download the latest version of this document from www.blizzardlighting.com.

Author:	Date:	Last Edited:	Date:
J. Thomas	6/9/2016	J. Thomas	9/14/2016

SAFETY INSTRUCTIONS



Please read these instructions carefully. They include important information about the installation, usage and maintenance of this product.

- Please keep this User Guide for future use. If you sell the unit to someone else, be sure that they also receive this User Guide.
- ALWAYS make sure that you are connecting to the proper voltage, and that the line voltage you are connecting to is not higher than that stated on the decal or rear panel of the fixture.
- This product is intended for indoor use only.
- To prevent risk of fire or shock, do not expose fixture to rain or moisture.
- Make sure there are no flammable materials close to the unit while operating.
- The unit must be installed in a location with adequate ventilation, at least 20in (50cm) from adjacent surfaces. Be sure that no ventilation slots are blocked.
- ALWAYS disconnect from the power source before servicing or replacing fuse and be sure to replace with same fuse size and type.
- ALWAYS secure fixture using a safety chain. NEVER carry the fixture by its cord. Use its carrying handles.
- DO NOT operate at ambient temperatures higher than 104°F (40°C).
- In the event of a serious operating problem, stop using the unit immediately. NEVER try to repair the unit by yourself. Repairs carried out by unskilled people can lead to damage or malfunction. Please contact the nearest authorized technical assistance center. Always use the same type spare parts.
- NEVER connect the device to a dimmer pack.
- Make sure the power cord is never crimped or damaged.
- Never disconnect the power cord by pulling or tugging on the cord.
- Avoid direct eye exposure to the light source while it is on.

Caution! There are no user serviceable parts inside this unit. Do not open the housing or attempt any repairs yourself. In the unlikely event your unit may require service, please visit <http://www.blizzardlighting.com/support>.

2. MEET THE OBERON™ PROFILE

MAIN FEATURES

- 1x 200W tungsten color COB LED, 50,000 hours
- Color temperature: 3200K, CRI: 95
- (4) blade manual framing shutters
- 1-20 fps strobe effects
- Smooth 0–100% linear dimmer
- 15-28° zoom (Profile NZ), or 20-45° zoom (Profile WZ)
- Low power consumption
- Standalone, master/slave mode
- 3/5-pin DMX input/output

ADDITIONAL FEATURES

- USITT DMX-512 (1/2-channels)
- 4-button LCD control panel menu
- PowerCon™ compatible in/out power connectors
- Available in black or white housing

DMX Values In-Depth (1CH/2CH Modes)

1CH	2CH	Value	What It Does
1	1	000 <--> 255	Dimmer Intensity
--	2	000 <--> 025 026 <--> 225 226 <--> 255	Strobe Shutter Open Strobe Effect (slow <--> fast) Shutter Open

Figure 1: The Oberon™ Profile Pin-Up Picture

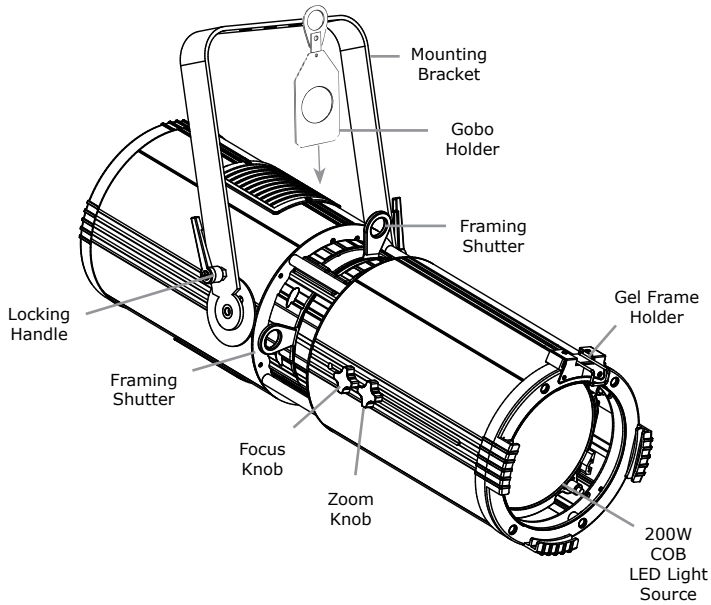
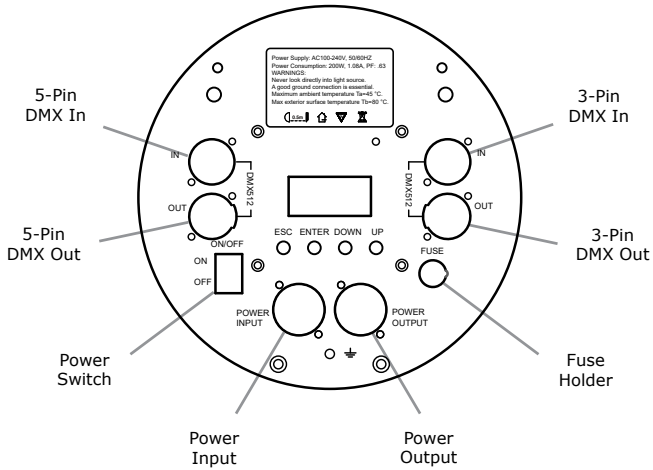

Figure 2: The Rear Connections



3. SETUP



Before replacing a fuse, disconnect power cord. ALWAYS replace with the same type and rating of fuse.

Fuse Replacement

Remove the fuse holder from of its housing. Then take out the damaged fuse from its holder and replace with exact same type of fuse. Reattach the fuse holder, and then reconnect power.

Connecting A Bunch of Oberon™ Profile Fixtures

You will need a serial data link to run light shows using a DMX-512 controller or to run shows on two or more fixtures set to sync in master/slave operating mode. The combined number of channels required by all the fixtures on a serial data link determines the number of fixtures the data link can support.

Fixtures on a serial data link must be daisy chained in one single line. Also, connecting more than 32 fixtures on one serial data link without the use of a DMX optically-isolated splitter may result in deterioration of the digital DMX signal. The maximum recommended cable-run distance is 500 meters (1640 ft). The maximum recommended number of fixtures on a serial data link is 32 fixtures.

Data/DMX Cabling

To link fixtures together you'll need data cables. You should use data-grade cables that can carry a high quality signal and are less prone to electro-magnetic interference.

For instance, Belden© 9841 meets the specifications for EIA RS-485 applications. Standard microphone cables will "probably" be OK, but note that they cannot transmit DMX data as reliably over long distances. In any event, the cable should have the following characteristics:

2-conductor twisted pair plus a shield
Maximum capacitance between conductors – 30 pF/ft.
Maximum capacitance between conductor & shield – 55 pF/ft.
Maximum resistance of 20 ohms / 1000 ft.
Nominal impedance 100 – 140 ohms

Cable Connectors

Cables must have a male XLR connector on one end and a female XLR connector on the other end. (Duh!)

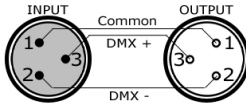

A Word on Termination: DMX is a resilient communication protocol, however errors still occasionally occur. Termination reduces signal errors, and therefore best practices include use of a terminator in all circumstances. If you are experiencing problems with erratic fixture behavior, especially over long signal cable runs, a terminator may help improve performance.

To build your own DMX Terminator:
Obtain a 120-ohm, 1/4-watt resistor, and wire it between pins 2 & 3 of the last fixture. They are also readily available from specialty retailers.

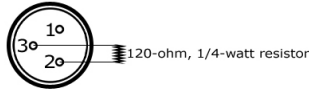

CAUTION: Do not allow contact between the common and the fixture's chassis ground. Grounding the common can cause a ground loop, and your fixture may perform erratically. Test cables with an ohm meter to verify correct polarity and to make sure the pins are not grounded or shorted to the shield or each other.

3-Pin??? 5-Pin??? Huh?!

If you use a controller with a 5-pin DMX output connector, use the 5-pin DMX input and/or output connections found on the back of your fixture(s).

Conductor	3-Pin Female (Output)	5-Pin Male (Input)
Ground/Shield	Pin 1	Pin 1
Data 1- (Primary Data Link)	Pin 2	Pin 2
Data 1+ (Primary Data Link)	Pin 3	Pin 3
Data 2- (Optional Secondary Data Link)	Pin 4	Pin 4
Data 2+ (Optional Secondary Data Link)	Pin 5	Pin 5

Take It To The Next Level: Setting Up DMX Control

Step 1: Connect the male connector of the DMX cable to the female connector (output) on the controller.

Step 2: Connect the female connector of the DMX cable to the first fixture's male connector (input).

Step 3: Connect other fixtures in the chain from output to input as shown below. Place a DMX terminator on the output of the final fixture to ensure best communication.

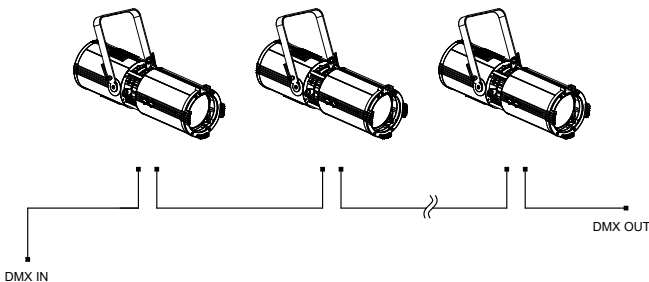

Connection With Mains

Step 1: Connect the fixture(s) to the mains with the supplied power cord. The connection must be connected to ground (earth).

Step 2: You can use PowerCon™ compatible interconnect power cables to safely power link up to 5 Oberon™ Profile fixtures at 100-120V.

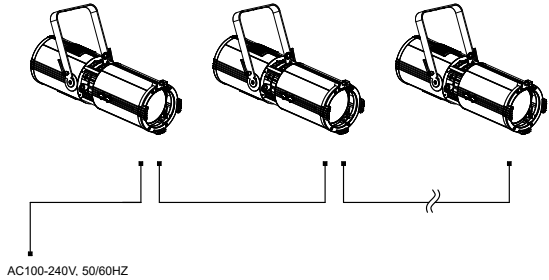

Mounting & Rigging

This fixture may be mounted in any SAFE position provided there is enough room for ventilation.

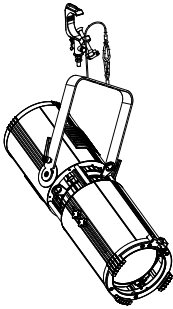

Mount the fixture using a suitable "C" or "O" type clamp. The clamp should be rated to hold at least 10x the fixture's weight to ensure structural stability. Do not mount to surfaces with unknown strength, and ensure properly "rated" rigging is used when mounting fixtures overhead.

Adjust the angle of the fixture by loosening both knobs and tilting the fixture. After finding the desired position, retighten both knobs.

A safety cable **MUST ALWAYS** be used.

Gobo Holder

Take out the gobo frame, loosen the screws, insert the gobo and re-tighten the screws. When complete, insert the gobo frame into the slot.

Color Gel Frame

Loosen the screws, insert a color gel sheet, and re-tighten the screws. When complete, insert the gel frame into the slot.

4. OPERATING ADJUSTMENTS

The Control Panel

All the goodies and different modes possible with the Oberon™ Profile are accessed by using the control panel on the rear of the fixture. There are 4 control buttons below the LCD display which allow you to navigate through the various control panel menus.

<ESC>

Is used to navigate to the previous higher-level menu item.

<ENTER>

Is used to select and confirm/store the current selection.

<DOWN>

Scrolls through menu items and numbers in descending order.

<UP>

Scrolls through menu items and numbers in ascending order.

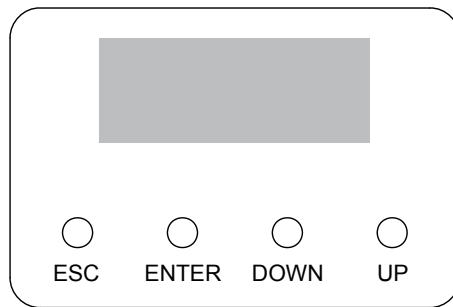

The control panel LCD display shows the menu items you select from the menu map on page #11. When a menu function is selected, the display will show immediately the first available option for the selected menu function. To select a menu item, press **<ENTER>**.

Use the **<UP>** and **<DOWN>** buttons to navigate the menu options. Press the **<ENTER>** button to select the menu function currently displayed, or to enable a menu option. To return to the previous option or menu without changing the value, press the **<ESC>** button.

Control Panel Menu Structure

Address 001	Code Add 001-511	To choose a DMX address from 001-511
Master Function	Master Off/On	Set as master fixture
Perform Function	Perform 000-002	Demo modes: 000=Off, 001=On, 002=Strobe
Channel Mode	Channel 1ch/2ch	Choose 1 or 2-channel DMX mode
ManDim 000	Man_Data 000-255	Dimmer intensity (0% <--> 100%)
Versions	Versions ver 1.0	Software version

DMX Mode

Allows the unit to be controlled by any universal DMX controller.

Setting the DMX Address:

1.) Navigate the main menu to reach **Address** and press **<ENTER>**. Then use the **<UP/DOWN>** buttons to highlight an address ranging from 001-511, and press the **<ENTER>** button to confirm your choice.

Select the DMX Channel Mode:

1.) Navigate the main menu to reach **Channel Mode** and press **<ENTER>**. Then use the **<UP/DOWN>** buttons to highlight either **1ch** or **2ch**, and press the **<ENTER>** button to confirm your choice.

Master/Slave Setting:

1.) Navigate the main menu to highlight **Master Function**, and press the **<ENTER>** button. Then use the **<UP/DOWN>** buttons to highlight either **Master On** or **Master OFF**, and press the **<ENTER>** button to confirm your choice.

Perform Function (Demo)

Allows users to set the fixture perform beam and strobe demos.

1.) Navigate the main menu to reach **Perform Function** and press **<ENTER>**. Then use the **<UP/DOWN>** buttons to highlight either **000** (off), **001** (on), or **002** (strobe), and press the **<ENTER>** button to confirm your choice.

Manual Dimmer

Using the manual dimmer found in the LCD menu in standalone mode:

***NOTE: This fixture features DMX512 dimming priority. When the unit is receiving a DMX signal, the manual dimmer settings in the LCD menu are invalid. Manual dimming via the control panel can only be used when not receiving a DMX signal.**

1.) To use the manual dimmer while not using DMX control, navigate the main menu to reach **ManDim** and press **<ENTER>**. Then use the **<UP/DOWN>** buttons to highlight a value ranging from 000-255 (0% <--> 100%), and press the **<ENTER>** button.

Zoom and Focus

1.) This fixture has the ability to manually zoom in/out and focus. When the lamp is on, loosen the zoom and focus knobs. Adjust the zoom level by sliding the zoom knob to your desired zoom level, then slide the focus knob to adjust the focus. Tighten both knobs down to secure your adjustments in place.

2.) When your projection distance changes, you can follow the same steps as above to resize and focus the beam again.

5. APPENDIX

A Quick Lesson On DMX

DMX (aka DMX-512) was created in 1986 by the United States Institute for Theatre Technology (USITT) as a standardized method for connecting lighting consoles to lighting dimmer modules. It was revised in 1990 and again in 2000 to allow more flexibility. The Entertainment Services and Technology Association (ESTA) has since assumed control over the DMX512 standard. It has also been approved and recognized for ANSI standard classification.

DMX covers (and is an abbreviation for) Digital MultipleXed signals. It is the most common communications standard used by lighting and related stage equipment.

DMX provides up to 512 control "channels" per data link. Each of these channels was originally intended to control lamp dimmer levels. You can think of it as 512 faders on a lighting console, connected to 512 light bulbs. Each slider's position is sent over the data link as an 8-bit number having a value between 0 and 255. The value 0 corresponds to the light bulb being completely off while 255 corresponds to the light bulb being fully on.

DMX data is transmitted at 250,000 bits per second using the RS-485 transmission standard over two wires. As with microphone cables, a grounded cable shield is used to prevent interference with other signals.

There are five pins on a DMX connector: a wire for ground (cable shield), two wires for "Primary" communication which goes from a DMX source to a DMX receiver, and two wires for a "Secondary" communication which goes from a DMX receiver back to a DMX source. Generally, the "Secondary" channel is not used so data flows only from sources to receivers. Hence, most of us are most familiar with DMX-512 as being employer over typical 3-pin "mic cables," although this does not conform to the defined standard.

DMX is connected using a daisy-chain configuration where the source connects to the input of the first device, the output of the first device connects to the input of the next device, and so on. The standard allows for up to 32 devices on a single DMX link.

Troubleshooting

Symptom	Solution
Fixture Auto-Shut Off	Check the fan in the fixture. If it is stopped or moving slower than normal, the unit may have shut itself off due to high heat. This is to protect the fixture from overheating. Clear the fan of obstructions, or return the unit for service.
No Light Output	Check to ensure fixture is operating under correct mode.
No Power	Check fuse, AC cord and circuit for malfunction.
Blown Fuse	Check AC cord and circuit for damage, verify that moving parts are not restricted and that unit's ventilation is not obstructed
Fixture Not Responding / Responding Erratically	Make sure all connectors are seated properly and securely. Use Only DMX Cables and/or check cables for defects Install a Terminator. Reset fixture(s).

Keeping Your Oberon™ Profile As Good As New

The fixture you've received is a rugged, tough piece of pro lighting equipment, and as long as you take care of it, it will take care of you. That said, like anything, you'll need to take care of it if you want it to operate as designed. You should absolutely keep the fixture clean, especially if you are using it in an environment with a lot of dust, fog, haze, wild animals, wild teenagers or spilled drinks.

Cleaning the optics routinely with a suitable glass cleaner will greatly improve the quality of light output. Keeping the fans free of dust and debris will keep the fixture running cool and prevent damage from overheating.

In transit, keep the fixtures in cases. You wouldn't throw a prized guitar, drumset, or other piece of expensive gear into a gear trailer without a case, and similarly, you shouldn't even think about doing it with your shiny new light fixtures.

Common sense and taking care of your fixtures will be the single biggest thing you can do to keep them running at peak performance and let you worry about designing a great light show, putting on a great concert, or maximizing your client's satisfaction and "wow factor." That's what it's all about, after all!

Returns (Gasp!)

We've taken a lot of precautions to make sure you never even have to worry about sending a defective unit back, or sending a unit in for service. But, like any complex piece of equipment designed and built by humans, once in a while, something doesn't go as planned. If you find yourself with a fixture that isn't behaving like a good little fixture should, you'll need to obtain a Return Authorization (RA).

Don't worry, this is easy. Just go to our website and open a support ticket at www.blizzardlighting.com/support, and we'll issue you an RA. Then, you'll need to send the unit to us using a trackable, pre-paid freight method. We suggest using USPS Priority or UPS. Make sure you carefully pack the fixture for transit, and whenever possible, use the original box & packing for shipping.

When returning your fixture for service, be sure to include the following:

- 1.) Your contact information (Name, Address, Phone Number, Email address).
- 2.) The RA# issued to you
- 3.) A brief description of the problem/symptoms.

We will, at our discretion, repair or replace the fixture. Please remember that any shipping damage which occurs in transit to us is the customer's responsibility, so pack it well!

Shipping Issues

Damage incurred in shipping is the responsibility of the shipper, and must be reported to the carrier immediately upon receipt of the items. Claims must be made within seven (7) days of receipt.

DISCLAIMER:

The power connector fitted to the fixture and fixture cord are designed for compatibility with products manufactured by Neutrik AG, Neutrik USA and their related entities, however they are not manufactured by, affiliated with or endorsed by Neutrik AG, Neutrik USA, or any related entity. Neutrik® and powerCON® are registered trademarks of Neutrik AG.

Tech Specs!

Weight & Dimensions	
Dimensions	Profile NZ: 29.7 x 9.4 x 9.4 in (754 x 237 x 237 mm) Profile WZ: 25.8 x 9.4 x 9.4 in (654 x 237 x 237 mm)
Weight	Profile NZ: 22.5lbs (10.2kg), Profile WZ: 20.3lbs (9.2 kg)
Power	
Operating Voltage	100-240VAC, 50-60 Hertz
Power Consumption	234W, 2.2A, PF: .98
Light Source	
LED	1x 200W 3200K COB LED, 50,000 hours
Optical	
Beam Angle	15-28 degree zoom (Profile NZ), 20-45 degree zoom (Profile WZ)
Luminous Flux	17,000lm/18,000lm, CRI: 95Ra
Gobo Size	85mm, image size 60mm
Thermal	
Max. Operating Temp.	104 degrees F (40 degrees C) ambient
Control	
Protocol	USITT DMX-512
DMX Channels	1 or 2-channel
Input/Output	3/5-pin XLR
Operating Modes	Standalone, Master/Slave Mode
Other Information	
Another day, another six pointless words.	
Warranty	2-year limited warranty, does not cover malfunction caused by LED damage.

Dimensional Drawings

Profile WZ

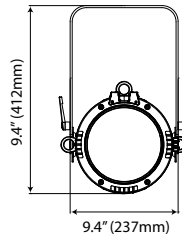
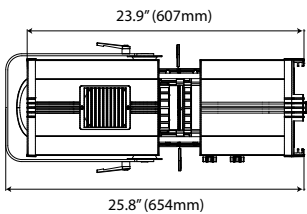

Profile NZ

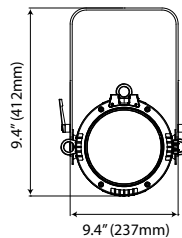
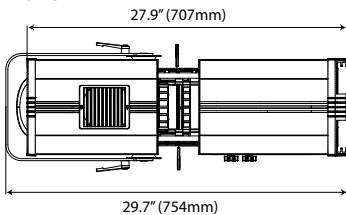

Photometric Data

Oberon™ Profile NZ:

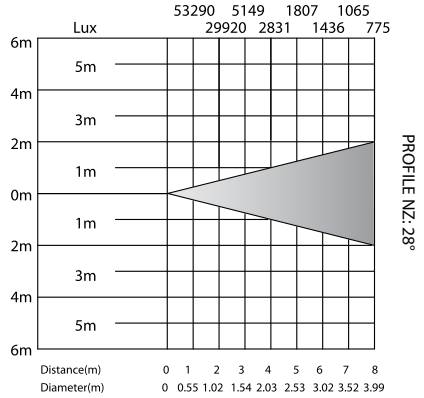
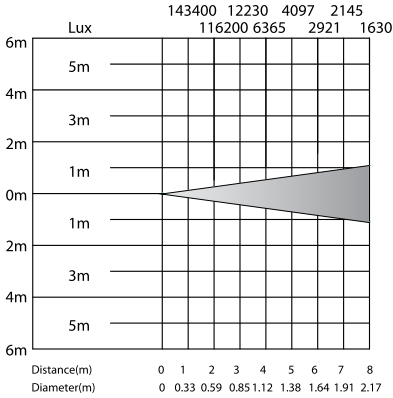

Oberon™ Profile WZ:

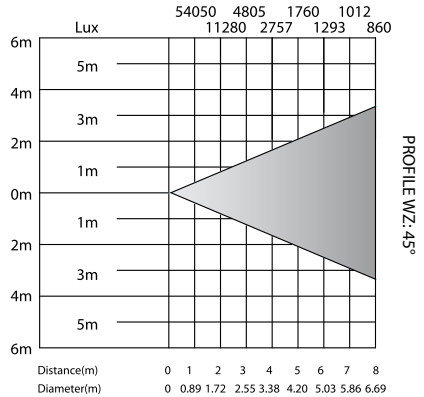
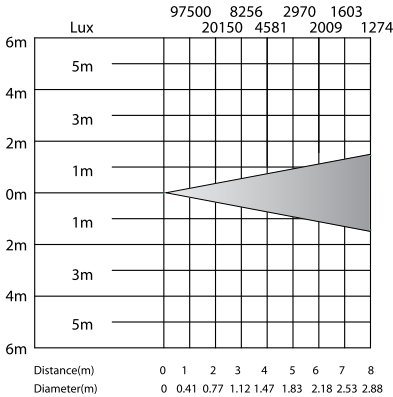



Enjoy your product!
Our sincerest thanks for your purchase!
--The team @ Blizzard Lighting