

ON[®] wave

direct digital synthesis FM



user guide

560T transmitter

500R receiver

506R receiver

)))))) **PhonicEar[®]**

specs available on-line at www.phonicear.com

FCC and Industry Canada Statements

This device complies with Part 15 of the FCC Rules. Operation is subject to the following two conditions: (1) this device may not cause harmful interference, and (2) this device must accept any interference received, including interference that may cause undesired operation.

This equipment has been tested and found to comply with the limits for a Class B digital device, pursuant to Part 15 of the FCC Rules. These limits are designed to provide reasonable protection against harmful interference in a residential installation. This equipment generates, uses and can radiate radio frequency energy and, if not installed and used in accordance with the instructions, may cause harmful interference to radio communications. However, there is no guarantee that interference will not occur in a particular installation. If this equipment does cause harmful interference to radio or television reception, which can be determined by turning the equipment off and on, the user is encouraged to try to correct the interference by one or more of the following measures:

- Reorient or relocate the receiving antenna.
- Increase separation between the equipment and receiver.
- Connect the equipment into an outlet on a circuit different from that to which the receiver is connected.
- Consult the dealer or an experienced radio/TV technician for help.

Per FCC Requirements, this transmitter is equipped with a special antenna connector to prevent the user from using antennas that have not been tested to comply with FCC regulations. Only use antennas and antenna accessories supplied by Phonic Ear.

The term "IC:" before the radio certification number only signifies that Industry of Canada technical specifications were met.

Caution: Any changes or modifications to this equipment not expressly approved by Phonic Ear could void the user's authority to operate the equipment.

table of contents

Transmitter: 560T	1-2
Wide-band Receiver: 500R	3
Narrow-band Receiver: 506R.	4
Ground Plane	5
Large Area Antenna.	6
OnWave System Setup and Operation	
Understanding hearing assistance	7
Direct-mount a standard antenna	7
Remote-mount a standard antenna	8
Remote-mount a large-area antenna	8
Mount the transmitter in rack or place on top of rack	9
Connect line input	9
Connect microphone input	10
Activate phantom power	10
Adjust output levels (with adjustable volume)	11
Adjust output levels (without adjustable volume)	11
Music or speech?	12
Set bass cut	12
Set transmitter band & channel	13
Tune 500R receiver	13
Set 506R channel	14
Walk and listen to confirm quality	14
Lock/unlock your settings	15
Save settings	15
Receiver batteries.	16
How to use the body-worn receiver	17
Warranty.	18
Troubleshooting	19

transmitter: 560T

- 1 digital display
- 2 level +
Increases output levels when the volume of the sound source cannot be adequately adjusted
- 3 level -
Reduces output levels when the volume of the sound source cannot be adequately adjusted.
- 4 function
Modifies the operation of other keys (see step-by-step instructions on the other side)
- 5 speech/music
The speech setting amplifies frequencies in the 160Hz to 6kHz speech bandwidth, and can be further customized using the bass cut options. The bandwidth for the music mode is expanded to 10kHz for a wider frequency response and fuller sound.
- 6 line/mic
Press to select line or mic input (see [4b](#) on page 10).
- 7 bass cut
Listeners with high-frequency hearing loss need high frequency emphasis and low frequency de-emphasis. Press this key to select 80Hz, 160Hz, or 320Hz output levels for these individuals. Also helps eliminate low frequency noise and 60 cycle electrical hum.
- 8 channel
Press the Channel key to select from 10 wide-band channels or 40 narrow-band channels. (Press the Function key followed by the Channel key to switch between wide and narrow-band transmission. Wide-band channels are indicated by letters, narrow-band channels are listed numerically.)
Check the front panel display to view the channel being selected.
- 9 power
- 10 rf fault indicator
Lights if antenna is connected incorrectly or if antenna is being detuned by other electrical equipment
- 11 overload indicator
Lights if input exceeds maximum level for transmitter. If this lights, reduce input level to transmitter. (See [5a](#) / [5b](#) on page 11)
- 12 rf out
Screw in an AT0777 antenna or antenna cable here (note that connector has left-handed thread). US models are required by the FCC to feature connectors unique to Phonic Ear to prevent the use of non-regulation antennas. Contact your Phonic Ear dealer.
- 13 speaker level input
To connect to levels of 2V, 10V or 70V_{RMS} use the terminal block input (sums inputs) and select the line level setting on the front panel [6](#).
- 14 universal line/mic input
Connect to sound system mixer via an XLR or 1/4in cable. For connection to a stand-alone mic use an XLR cable (see page 11). Activate phantom power for use with condenser mics.
- 15 power input

transmitter: 560T (cont'd)

front

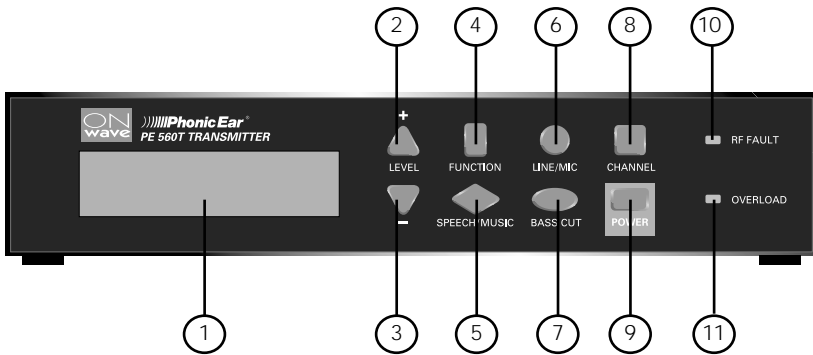

back

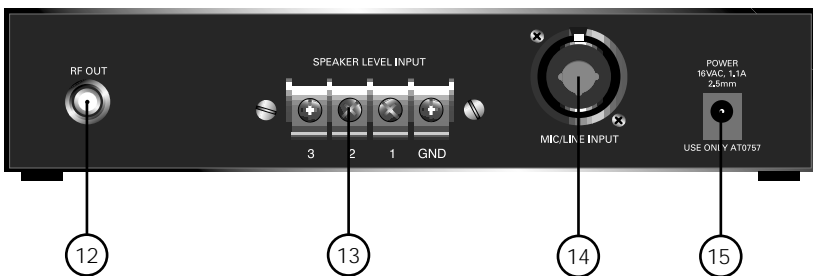

wide-band receiver: 500R

22 volume/power

23 charge socket
1.3mm power jack. Connects to 500C and AT0749 charger to recharge NiCad batteries (Never recharge Alkaline batteries!)

24 accessory socket
Connect listening accessories such as teleloops, earbuds, and headsets. 3.5mm; stereo headset compatible.

25 indicator light
Lights when unit is on; flashes when batteries are low (2 hours remaining battery life); lights brighter when charging

26 tuning screw
Multi-turn screw for setting the receiver frequency. Pre-tuned to 72.9 MHz (channel E). (see [8b](#) on page 13)

27 battery door
Use 950mA/Hr rechargeable NiCad or disposable alkaline batteries (never recharge alkaline batteries!)

front

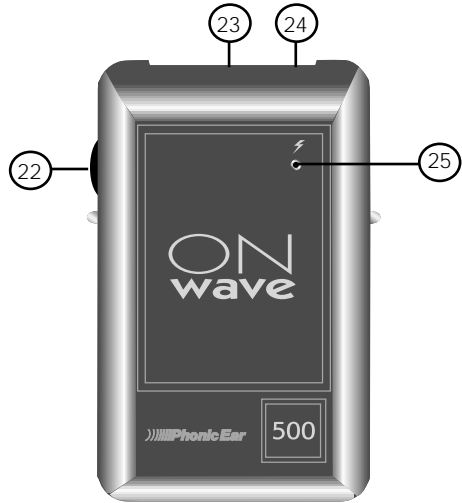

back

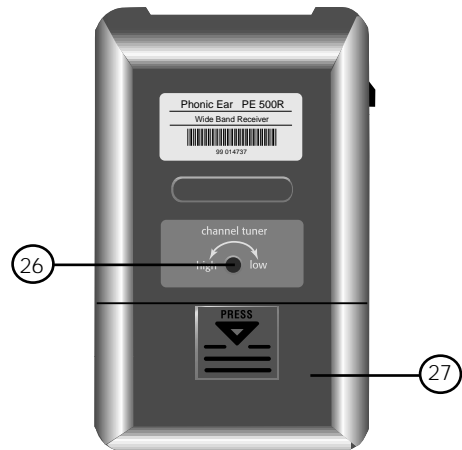

channel	frequency	channel	frequency	channel	frequency
A	72.1	E	72.9	H	75.9
B	72.3	F	75.5	I	74.7
C	72.5	G	75.7	J	75.3
D	72.7				

narrow-band receiver: 506R

28 accessory/charge socket
3.5mm jack. Connect listening accessories such as teleloops, earbuds, and headsets. Also connects to 300C and AT0534 charger to recharge NiCad batteries (Never recharge Alkaline batteries!)

29 charge light

30 channel selector
Choose one of six different channels.
The frequency of each channel is identified inside the battery compartment (see [8C])

31 frequency code label (inside)
Identifies the frequency code for each of the six available channels

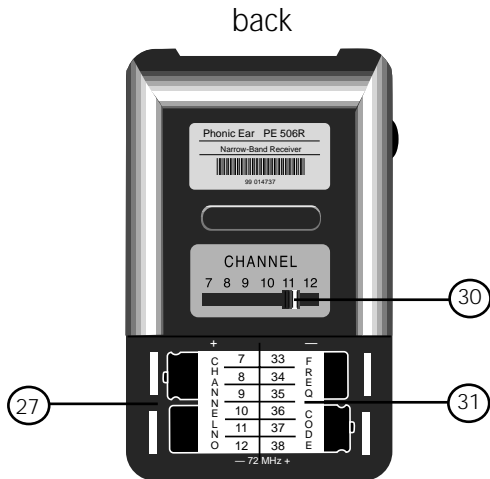
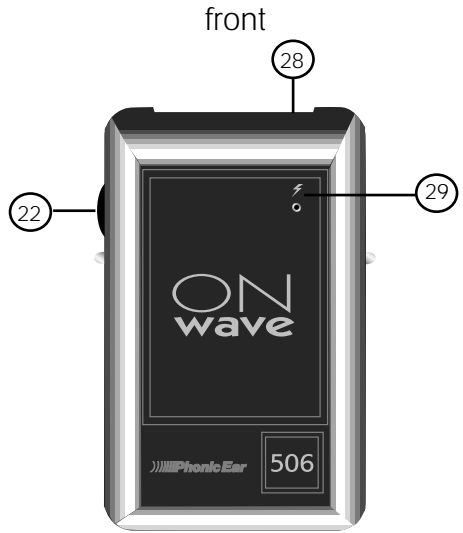

low band

mid band

high band

channel	frequency code	frequency	channel	frequency code	frequency	channel	frequency code	frequency
1	1	72.025	7	33	74.625	13	22	75.475
2	5	72.225	8	34	74.675	14	24	75.575
3	11	72.525	9	35	74.725	15	26	75.675
4	14	72.675	10	36	74.775	16	28	75.775
5	17	72.825	11	37	75.225	17	30	75.875
6	19	72.925	12	38	75.275	18	32	75.975

ground plane (note that connectors have left-handed thread)

16 antenna jack
Attach antenna here

17 cable jack
Attach cable here

18 mounting holes
Use screws to mount on
a wall or, preferably, a
ceiling; may also be
placed on a tabletop

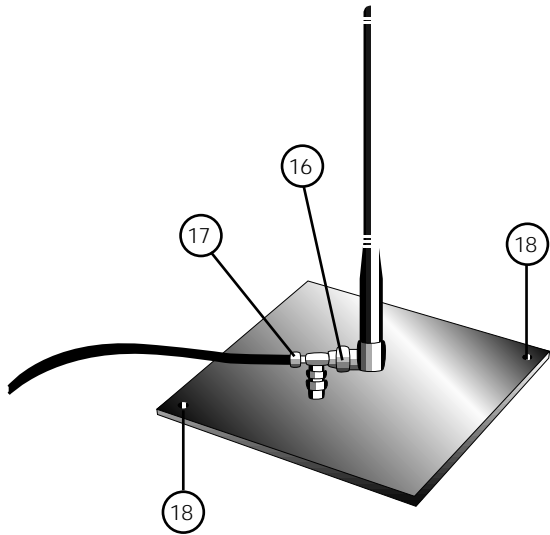

large area antenna

- 19 tuning ring
Do not deform or move this ring, or you may affect the antenna's tuning and efficiency
- 20 worm clamps
Loosen both clamps; extend the large center section to the black ring; tighten lower clamp; extend the smaller element to the black ring; tighten the top clamp
- 21 mounting hole/set screw
Use to mount on a tripod with a mast. Ground your mounting pole, tripod, or other holder to a metal surface. You may also hang the antenna from a railing or metal superstructure (such as in a stadium).
- ! warning
The antenna is an electrical conductor. Contact with power lines can result in death or serious injury. Do not install the antenna, supporting mast, or tower where there is any possibility of contact with a high-voltage arc from power cables or service drops. Outdoor antennas should be grounded against lightning strikes. Consult the National Electrical Code for further details.

The large area antenna is only available with a specially tuned version of the 560T (model # 560T-LA). This is done to insure the system meets FCC and Industry Canada Requirements. This antenna should only be installed by a qualified sound contractor or factory trained professional.

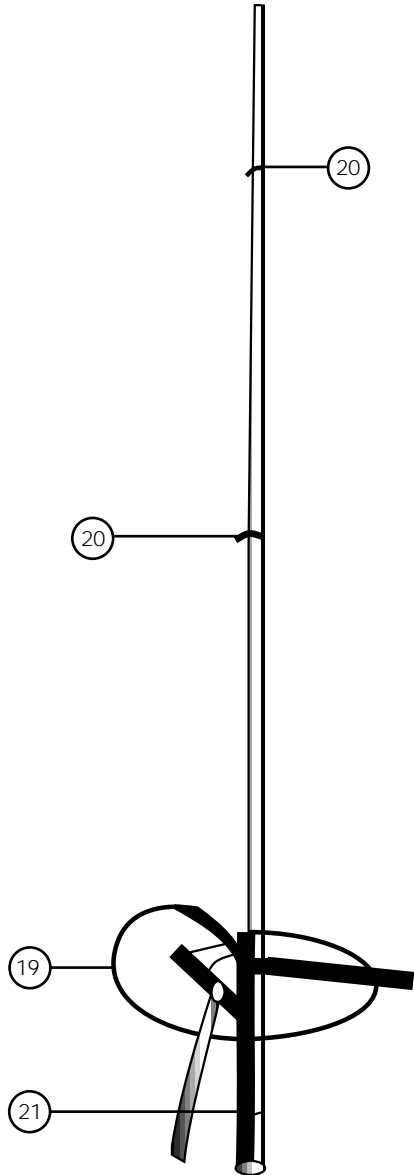

OnWave system setup and operation

1 understanding hearing assistance

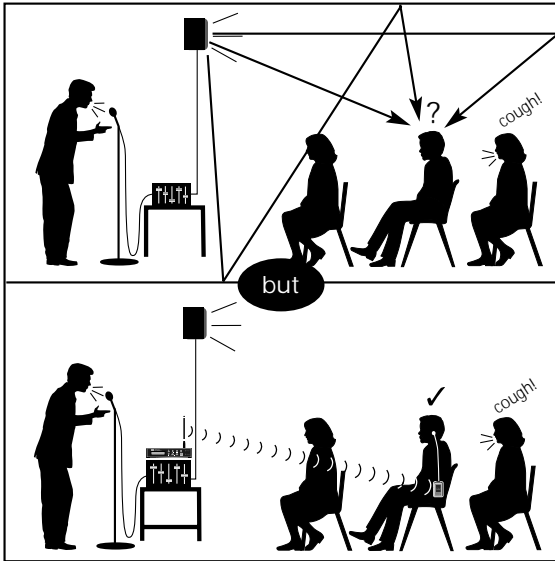

without the OnWave system

- distance
- noise
- echo

with the OnWave system

- distance
- noise
- echo

2a direct-mount a standard antenna



1 Attach antenna to back of transmitter

2 Check RF Fault indicator. If lit, adjust antenna connection or remote mount antenna.

or continue to 2b

OnWave system setup and operation (cont'd)

2b remote-mount a standard antenna optimizes transmitter/antenna position

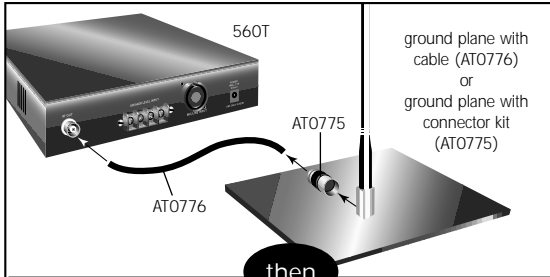

then

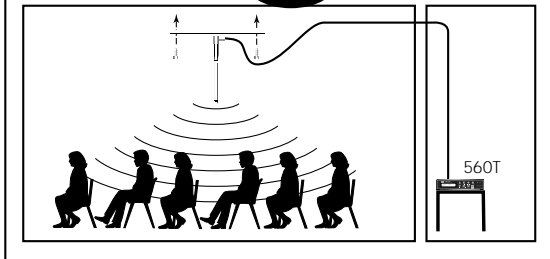

or

2c remote-mount a large-area antenna optimizes transmitter/antenna position

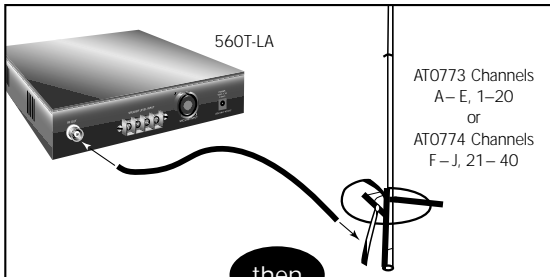

then

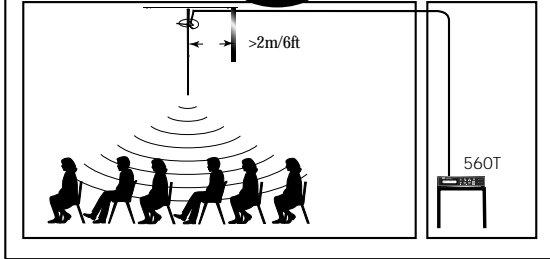

NOTE:

! Ground mounting pole or holder.

! Ground antenna if outdoors.

! Do not install near power cables or service drops.

! Do not install parallel to metal structure within 2m/6ft (perpendicular to metal ok)

OnWave system setup and operation (cont'd)

3 mount the transmitter in rack
(requires remote mounting antenna)
or place on top of rack

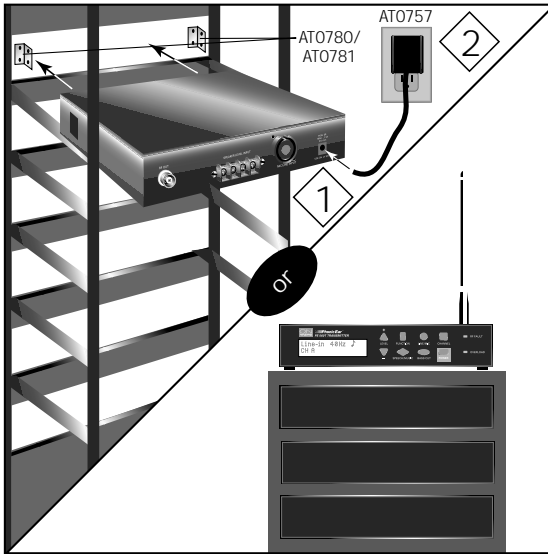

- 1 Plug transformer into OnWave power input
- 2 Plug transformer into wall socket

4a connect line input

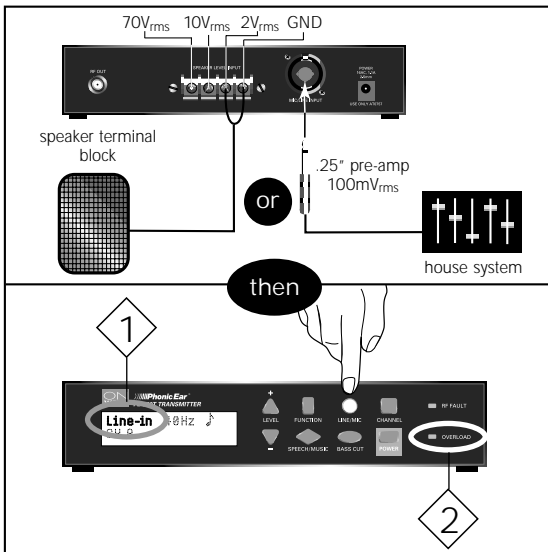

- 1 Select *Line-in*
- 2 If overload indicator lights when connecting the sound system, use XLR 250 mV_{rms} input

or continue to **4b**

OnWave system setup and operation (cont'd)

4b connect microphone input

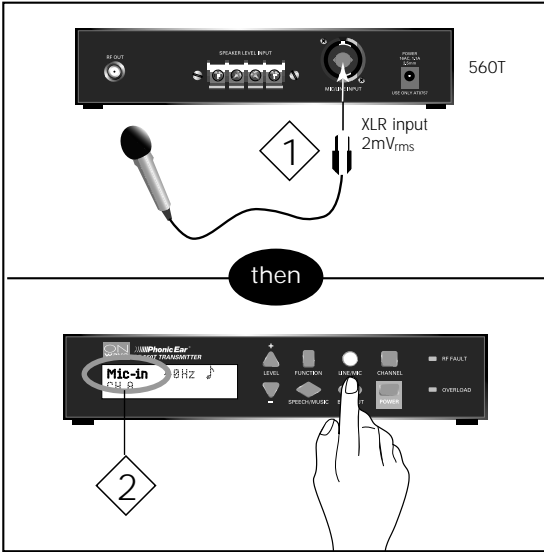

1 Plug in microphone

2 Select *Mic-in*

4c activate phantom power (for electret condenser mics only†)

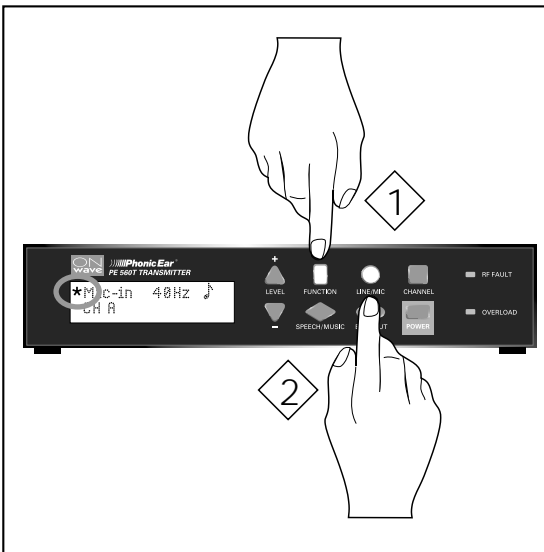

1 Press *function*

2 Press *line/mic*

Repeat steps to deactivate phantom power

† *Use phantom power only with condenser microphones. Plugging dynamic mic in while phantom power is activated may damage the microphone*

OnWave system setup and operation (cont'd)

5a

adjust output levels
(if your house system has adjustable volume)

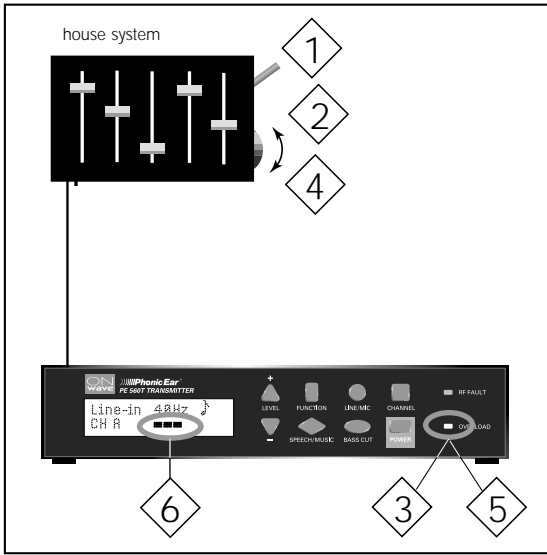

- 1 Turn on and play test signal
- 2 Increase sound system volume until...
- 3 ...overload indicator lights
- 4 Slowly decrease sound system volume until...
- 5 ...overload indicator goes out
- 6 Confirm that meter peaks with signal

or

5b

adjust output levels
(if your house system has no adjustable volume or if further adjustment is required)

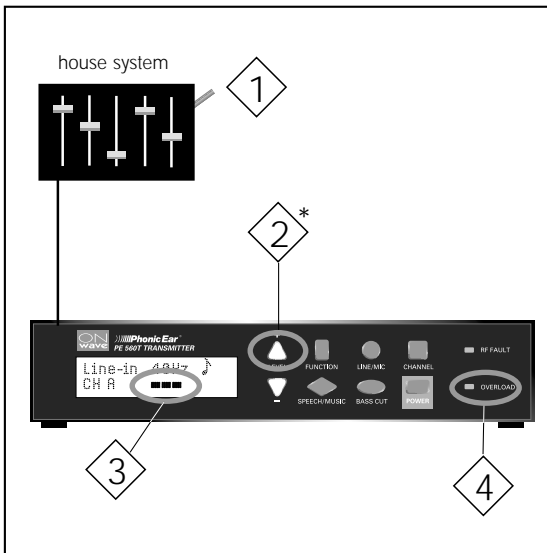

- 1 Turn on and play test signal
- 2 Increase transmitter level* until...
- 3 2-3 indicator bars appear and peak with signal
- 4 Confirm that overload indicator is off

* When transmitter level is increased, the auto line level control is activated and signal strength is automatically adjusted for maximum volume without distortion or clipping.

OnWave system setup and operation (cont'd)

6

music or speech?

(set for typical signal content)

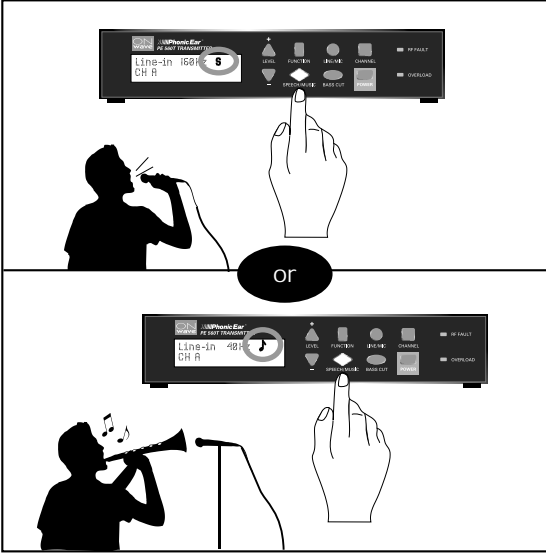

7

set bass cut

(optimize for listeners or to reduce low-freq noise)

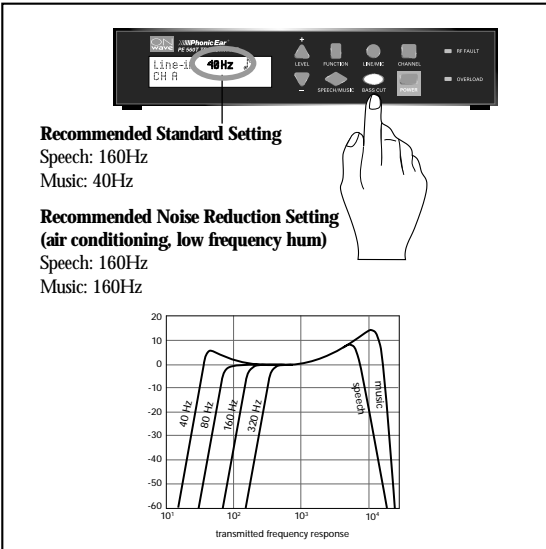

OnWave system setup and operation (cont'd)

8a

set transmitter band & channel

(optional; must tune your receiver to match!)

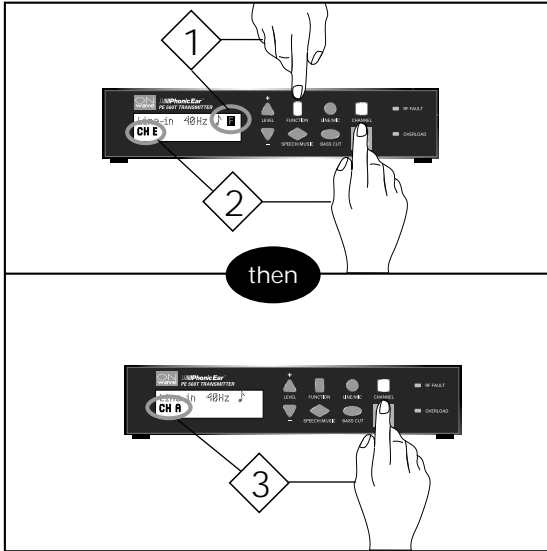

- 1 Press *function*
- 2 Press *channel* to select wide-band for 500R (channels indicated by letters) or narrow-band for 506R (channels indicated by numbers)
- 3 Press *channel* to select channel within your chosen band

For narrow-band channel and frequency information see 506R receiver diagram on other side.

8b

tune 500R receiver

(must match your transmitter!)

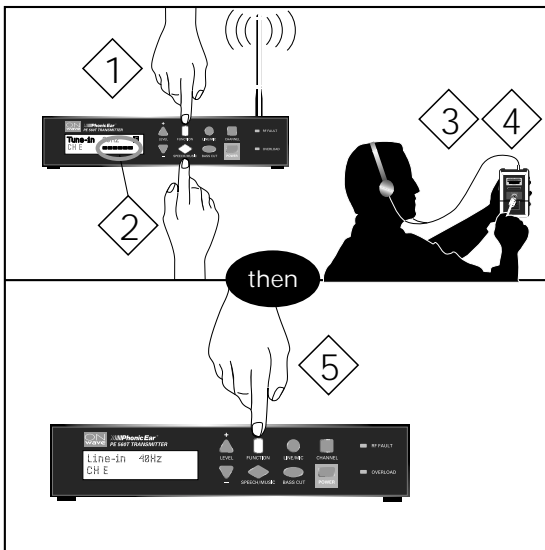

- 1 Press *function*
- 2 Press *speech/music* to activate test tone
- 3 Set receiver at lowest volume
- 4 Adjust screw until test tone is audible
(Note: screw may require several turns to locate channel)
- 5 Press *function* to deactivate test tone

OnWave system setup and operation (cont'd)

10 lock/unlock your settings

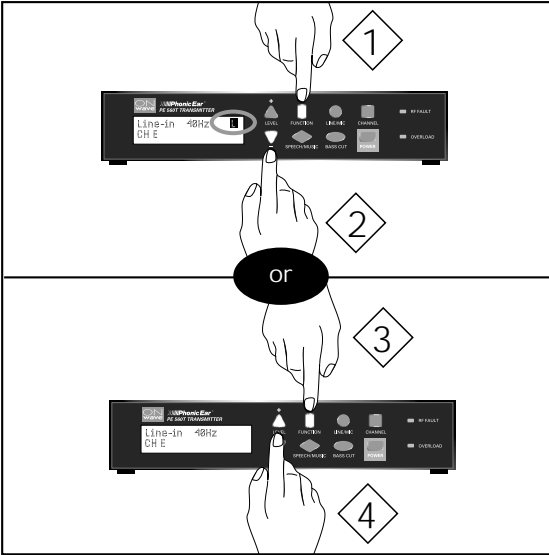

- 1 Press *function*
- 2 Press *level-* to lock

- 3 Press *function*
- 4 Press *level+* to unlock

11 save settings

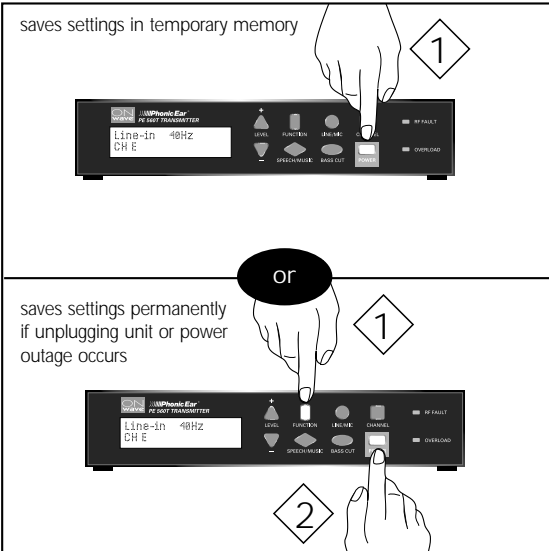

saves settings in temporary memory

- 1 Press *power* to turn unit off and save settings

saves settings permanently if unplugging unit or power outage occurs

- 1 Press *function*
- 2 Press *power*

OnWave system setup and operation (cont'd)

12 receiver batteries

batteries are low



1 Light flashes when 2 hours of battery life remain (4 hours with alkaline battery)

warning!



Place charger case on its side when connecting to charger cord.

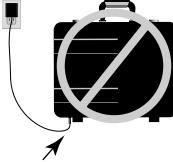

Do not stand charger case on bottom when charging. Damage to charger may occur.



charge

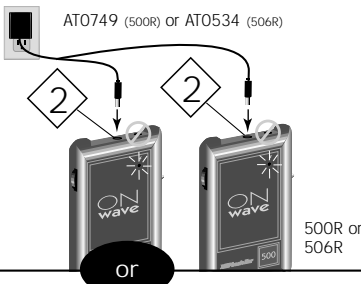

2 Plug charger cord into charger jack, **not** accessory jack

NOTE: Never recharge Alkaline batteries

replace



OnWave system setup and operation (cont'd)

13 how to use the body-worn receiver

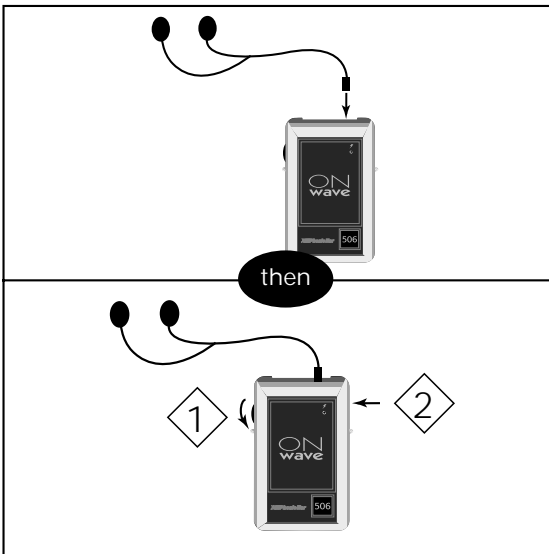
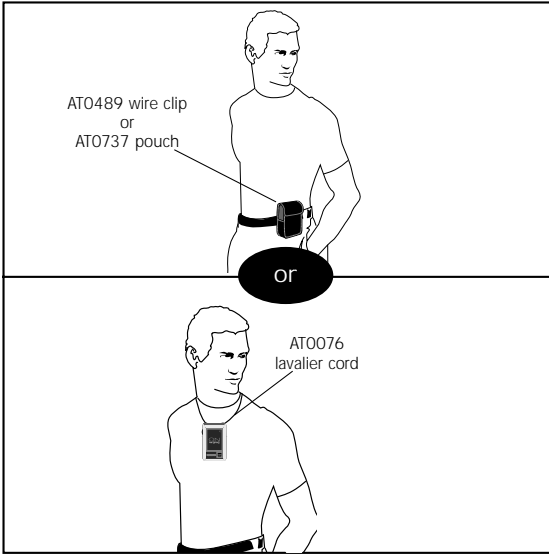

- 1 On/Volume
(verify power light is on)
- 2 Switch to channel/
program (506R only)

warranty

time period of warranty

This warranty will go into effect upon the date of purchase and will stay in effect as long as the instrument remains the property of the original owner. ONWAVE® has a 3-year warranty.

what is covered by this warranty

Any electronic component, which because of workmanship, manufacturing or design defects, fails to function properly under normal use during the life of this warranty will be replaced or repaired at no charge for parts or labor, when returned to the factory service center. Transportation in and out is paid by the customer. If it is determined that repair is not feasible, the entire unit may be replaced with an equivalent unit upon mutual agreement of the manufacturer and customer.

what is not covered by this warranty

This limited warranty does not apply to:

1. Malfunctions resulting from abuse, neglect or accident
2. Instruments connected, installed, used or adjusted in any manner contrary to instructions provided by the manufacturer
3. Consequential damages and damages resulting from delay or loss of this instrument. The exclusive remedy under this warranty is strictly limited to repair or replacement as herein provided
4. Products damaged in transit unless investigated by the shipper and returned to the warrantor with the investigation report
5. Peripheral accessories as itemized within the product specification sheet as applicable, when such items are returned within 90 days from original purchase
6. Batteries if applicable

Phonic Ear Inc. reserves the right to make changes in the design or construction of any of its instruments at any time without incurring any obligation to make any changes whatsoever on units previously purchased.

This warranty is in lieu of all other expressed warranties. All expressed and implied warranties will terminate upon the expiration of this written warranty. No representative or person is authorized to represent or assume for us any liability in connection with the sale or use of our products other than as set forth above.

what to do if you have questions

If you have any questions about service, call the service department at 800.227.0735, then press 7.

what to do if you need service

If you require service under the warranty terms, obtain a service order form either online at www.phonicear.com/support.asp or through our U.S. customer service department at 800.227.0735, then press 5 (or +1.707.769.1110 outside the U.S.). Fill the form out completely remembering to include:

1. Description of the problem
2. Your billing address
3. Your shipping address (if different from billing address)
4. Contact name and phone number
5. A P.O. number if the equipment is not under a warranty or service contract

Then, carefully package the equipment in the original shipping container to prevent damage and send it **postpaid to the service center near you:**

USA/International:

Phonic Ear Inc.

3880 Cypress Drive
Petaluma, CA 94954-7600
U.S.A.

In Canada:

Phonic Ear Ltd.

10-7475 Kimbel Street
Mississauga, Ontario
L5S 1E7 Canada

what to do if you have questions

If you have any questions about service, call the service department at 800.227.0735, then press 7.

about your batteries

To ensure that your batteries are as fresh as possible upon arrival, we have intentionally not installed them in your equipment.

install your batteries in your equipment now, then charge overnight before initial use (see user guide for charging procedure).

avoid battery corrosion

To avoid battery corrosion and damage to your equipment, do not recharge disposable or rechargeable alkaline batteries. Before charging any Phonic Ear equipment make sure only NiCad or NiMH rechargeable batteries are installed. As an added precaution, remove batteries if the equipment will not be used for several weeks.

troubleshooting

no sound

- If using the 500R, verify the receiver is tuned correctly (see user instructions section [8b](#))
- If using the 506R, verify the channel selected on the receiver matches the channel selected on the transmitter (see user instructions section [8c](#))
- If using 500R, check if the receiver power indicator light is on; if unlit, or flashing, replace or recharge receiver batteries.
- Check if the transmitter is on (the front panel display window should be lighted).
- Verify the wall transformer is plugged into the transmitter and into a working wall outlet.

flashing light on receiver

- Replace or recharge batteries

sound too low/poor quality sound

- Check the transmitter line level indicators located in the display window. 2-3 bars should peak with the audio signal. If no bars or only one bar appears, increase the volume on the sound system and, if necessary, on the transmitter level control. Connect the sound system to the $\frac{1}{4}$ in input on the transmitter for maximum output levels. Change to higher level output connection on the sound system.

RF fault indicator is lighted

- Confirm that the antenna is connected properly to the transmitter. Relocate the antenna away from any metal structures, power cords, or electronic equipment (see user instructions section [2b](#)).

intermittent audio

- Replace the receiver listening accessory.
- Check the RF fault indicator on the transmitter front panel and follow above instructions if lighted.
- The receiver may be out of range; for areas greater than 100m/300ft use a large area antenna.

overload indicator is lighted

- Confirm that the mic/line setting on the transmitter front panel is correct.
- Reduce the output level on the sound system.
- Connect the sound system to the XLR or speaker level inputs located on the back of the transmitter to reduce level.
- Change to lower output connection on the sound system.

low frequency hum

- Adjust the transmitter front panel bass cut settings to 160Hz or 320Hz
- Relocate the antenna away from electronic equipment, (see user instructions section [2b](#)).

batteries won't recharge

- Verify that the wall transformer is plugged into the charger.
- Try different charge cords.
- Verify the receiver indicator light is brighter when the unit is plugged into charger.
- Check the receiver is turned off before charging.
- Check the receiver batteries are Nicad rechargeable.

us: 800.227.0735, then press 5 • canada: 800.263.8700
outside u.s./canada: Call your local Phonic Ear dealer • website: www.phonicear.com

© 2005 Phonic Ear Inc. Phonic Ear and the names of Phonic Ear products are trademarks or registered trademarks of Phonic Ear Inc. in the U.S. and other countries.

821-7289-102/rev. F/4751 0305