

Install

ATHENS

TCS122/96-R

Arrayable 2 Way 12" Full Range Loudspeaker with Dendritic Waveguide for Installation Applications, 90° H x 60° V Dispersion (Weather Resistant)

- Arrayable 2 way full range loudspeaker for installation applications
- Rotatable Dendritic waveguide with 90° H x 60° V dispersion
- 600 Watts continuous, 2,400 Watts peak power
- All components weather resistant to IP54 for outdoor use
- Glass fibre loaded 12" low frequency driver with aluminium voice coil for improved transient response
- Titanium dome 1.4" neodymium motor compression driver
- Multiple array configurations for extended coverage
- Switchable passive/bi-amp operation for flexibility of use
- Trapezoidal cabinet shape enables visually unobtrusive loudspeaker arrays
- Multiple internal rigging points allow bracket mount and suspension in any orientation
- 15 mm (5/8") birch plywood enclosure with hard wearing semi matt black paint finish
- Architecturally styled powder coated perforated plated steel mesh grille with foam backing
- Captive cable tail with sealed cable gland on aluminium connector panel
- 10-Year Warranty Program*
- Designed and engineered in the U.K.

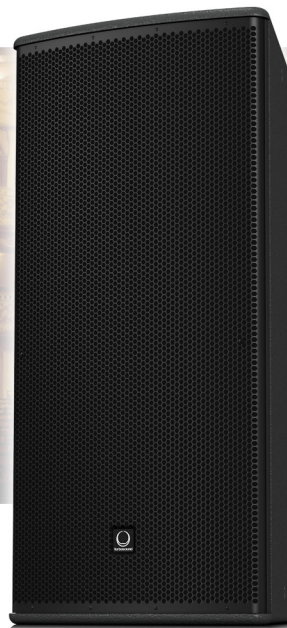

Weather resistant for outdoor use to IP54, the 2,400 Watt TCS122/96-R arrayable two-way 12" loudspeaker system is ideally suited for a wide range of speech and music sound reinforcement applications. The TCS122/96-R is designed to work in conjunction with **TURBOSOUND** loudspeaker management systems, providing optimal FOH performance, as well as offering considerable flexibility to readily adapt to varying venue requirements.



The TCS122/96-R features a glass fibre loaded 12" low frequency driver with an aluminium voice coil for improved transient response. The titanium dome 1.4" neodymium motor compression driver is mounted on a rotatable 90° horizontal by 60° vertical proprietary Dendritic waveguide, which features multiple hornlets with identical path lengths to provide a flat constant-phase wavefront. When the waveguide is rotated 90° from the standard position a 60° horizontal by 90° vertical dispersion is achieved, making the TCS122/96-R ideal for an even broader range of applications.

Install

ATHENS TCS122/96-R

Arrayable 2 Way 12" Full Range Loudspeaker
with Dendritic Waveguide for Installation
Applications, 90° H x 60° V Dispersion
(Weather Resistant)

Finished in a highly durable weather resistant semi matt black paint, the trapezoidal cabinet is constructed from 15 mm (5/8") birch plywood – and includes a rugged outdoor powder coated perforated zinc plated steel mesh grille. Multiple rigging points allow bracket mount suspension in any orientation, or mounting with dedicated brackets – available separately. A dedicated range of fly plates and coupler kits are also available separately for constructing tightly packed custom full-range and subwoofer enclosure arrays for aesthetically pleasing and venue specific coverage requirements. Connectivity is provided in the form of a captive cable tail, which enters the cabinet by means of a sealed cable gland on an aluminium panel.



You Are Covered

We always strive to provide the best possible Customer Experience. Our products are made in our own [MUSIC Tribe](#) factory using state-of-the-art automation, enhanced production workflows and quality assurance labs with the most sophisticated test equipment available in the world. As a result, we have one of the lowest product failure rates in the industry, and we confidently back it up with a generous [Warranty program](#).

Install

ATHENS

TCS122/96-R

Arrayable 2 Way 12" Full Range Loudspeaker
with Dendritic Waveguide for Installation
Applications, 90° H x 60° V Dispersion
(Weather Resistant)

Frequency Response Sensitivity 1 W / 1 m

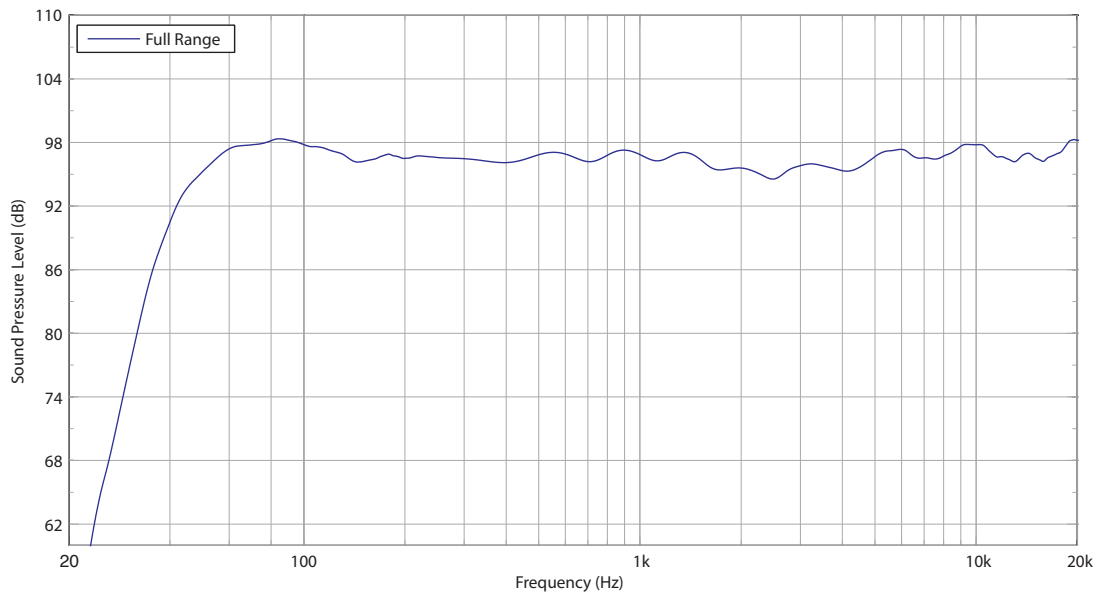

Impedance

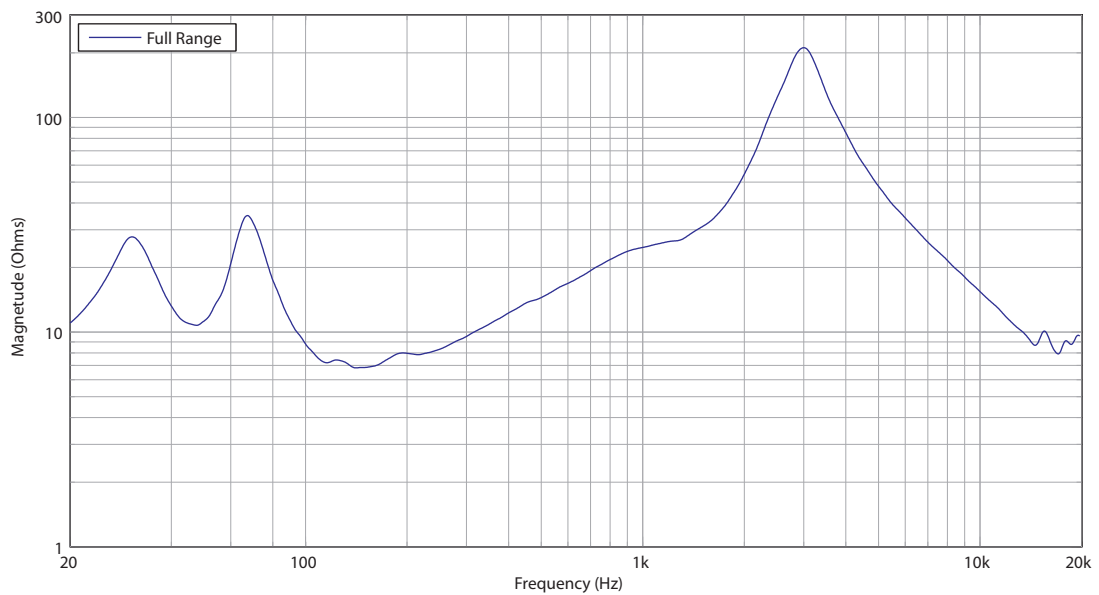

Install

ATHENS

TCS122/96-R

Arrayable 2 Way 12" Full Range Loudspeaker
with Dendritic Waveguide for Installation
Applications, 90° H x 60° V Dispersion
(Weather Resistant)

Horizontal Beamwidth

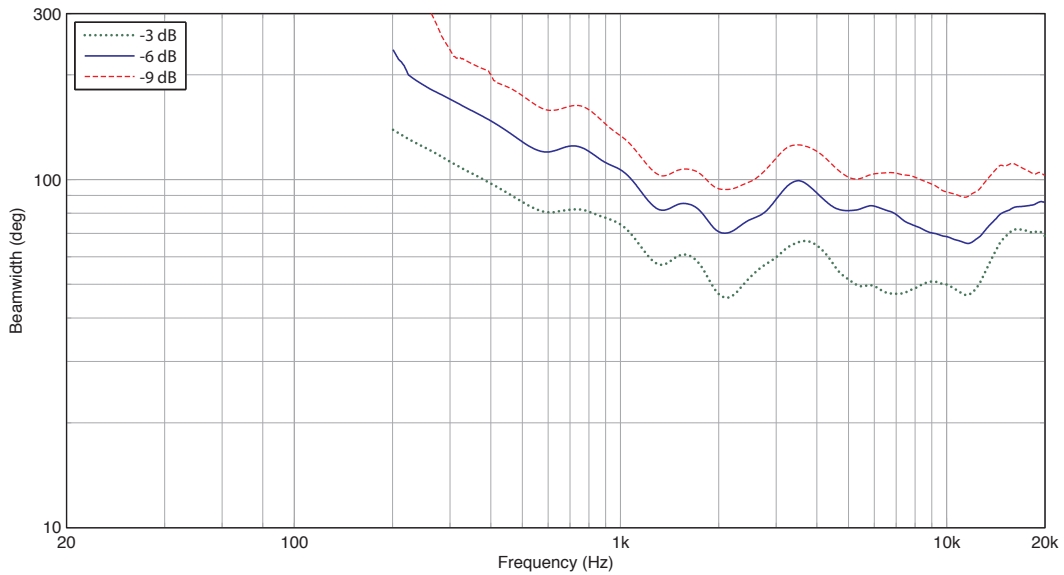

Vertical Beamwidth

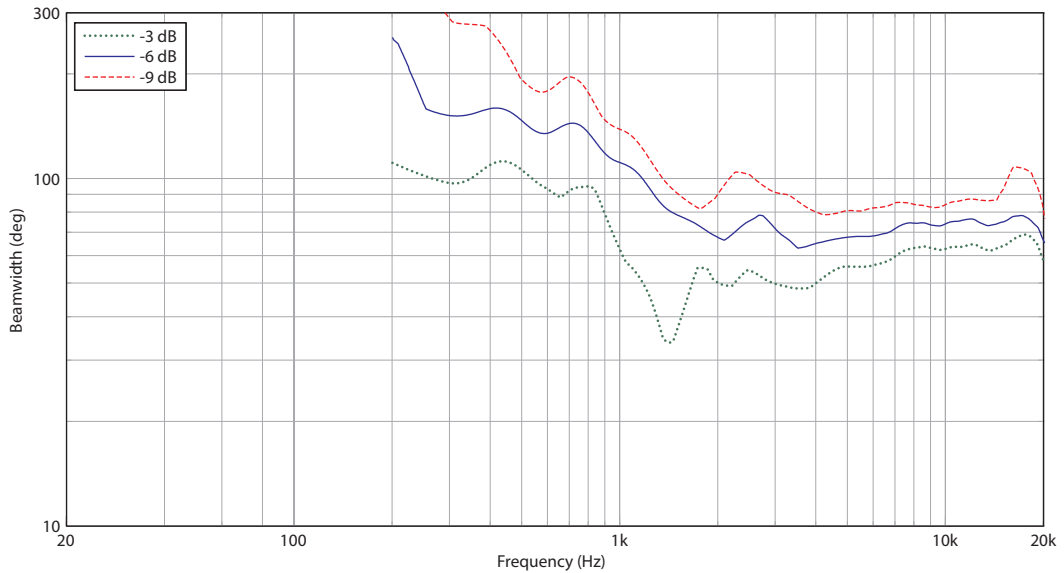

Install

ATHENS

TCS122/96-R

Arrayable 2 Way 12" Full Range Loudspeaker
with Dendritic Waveguide for Installation
Applications, 90° H x 60° V Dispersion
(Weather Resistant)

Horizontal Polar Plots

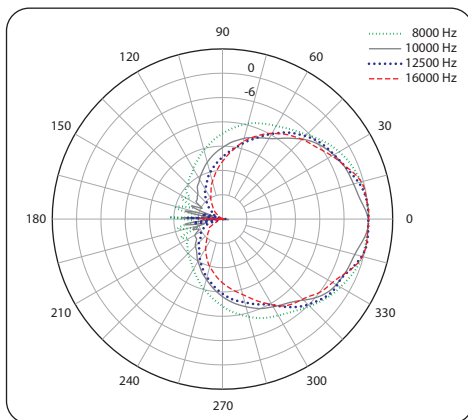
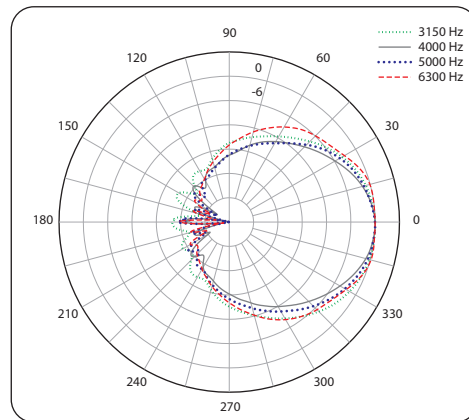
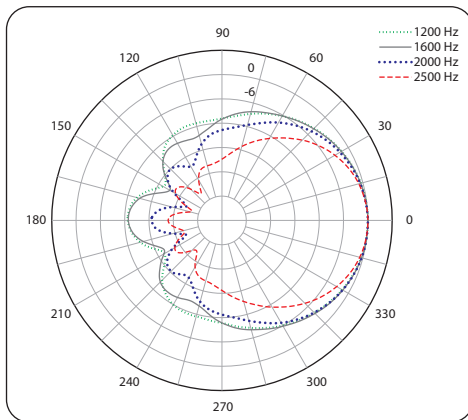
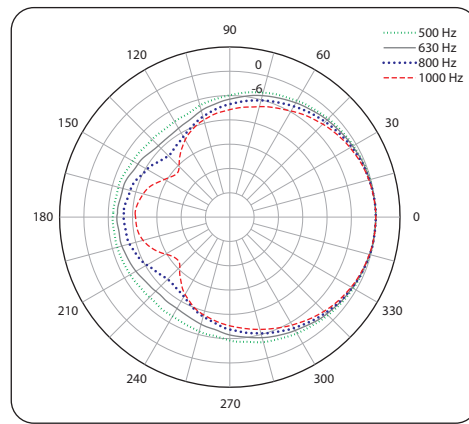
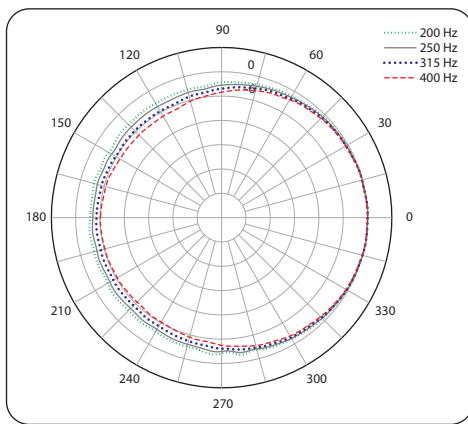

Install

ATHENS

TCS122/96-R

Arrayable 2 Way 12" Full Range Loudspeaker
with Dendritic Waveguide for Installation
Applications, 90° H x 60° V Dispersion
(Weather Resistant)

Vertical Polar Plots

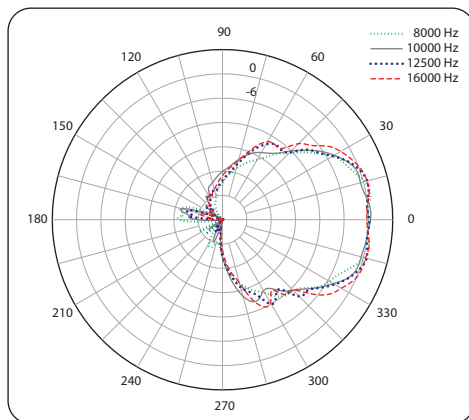
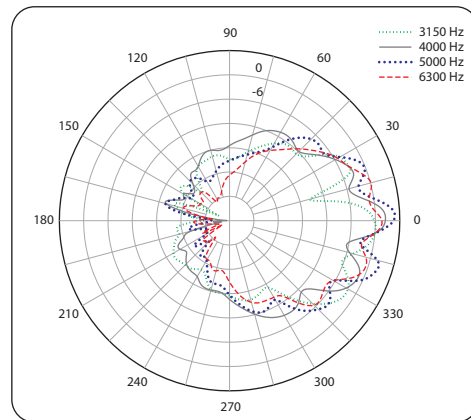
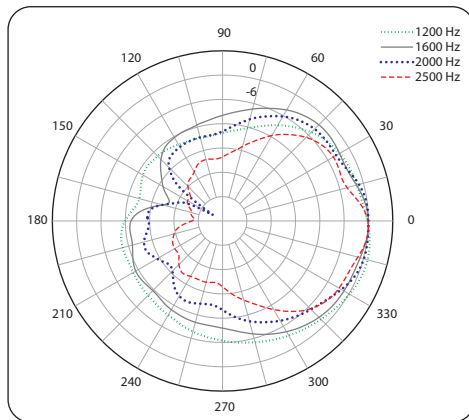
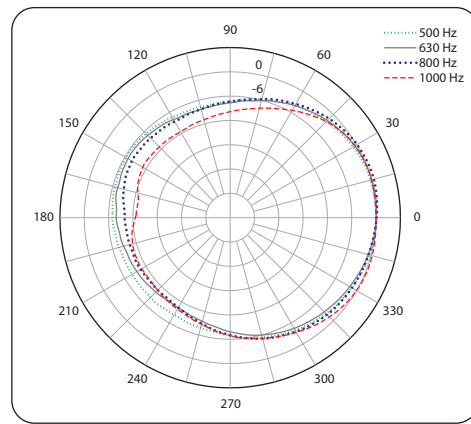
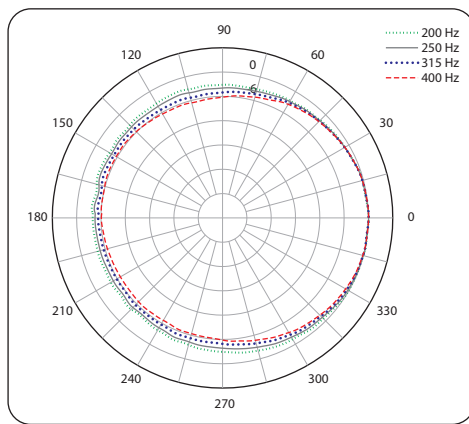

Install

ATHENS

TCS122/96-R

Arrayable 2 Way 12" Full Range Loudspeaker
with Dendritic Waveguide for Installation
Applications, 90° H x 60° V Dispersion
(Weather Resistant)

Dimensions

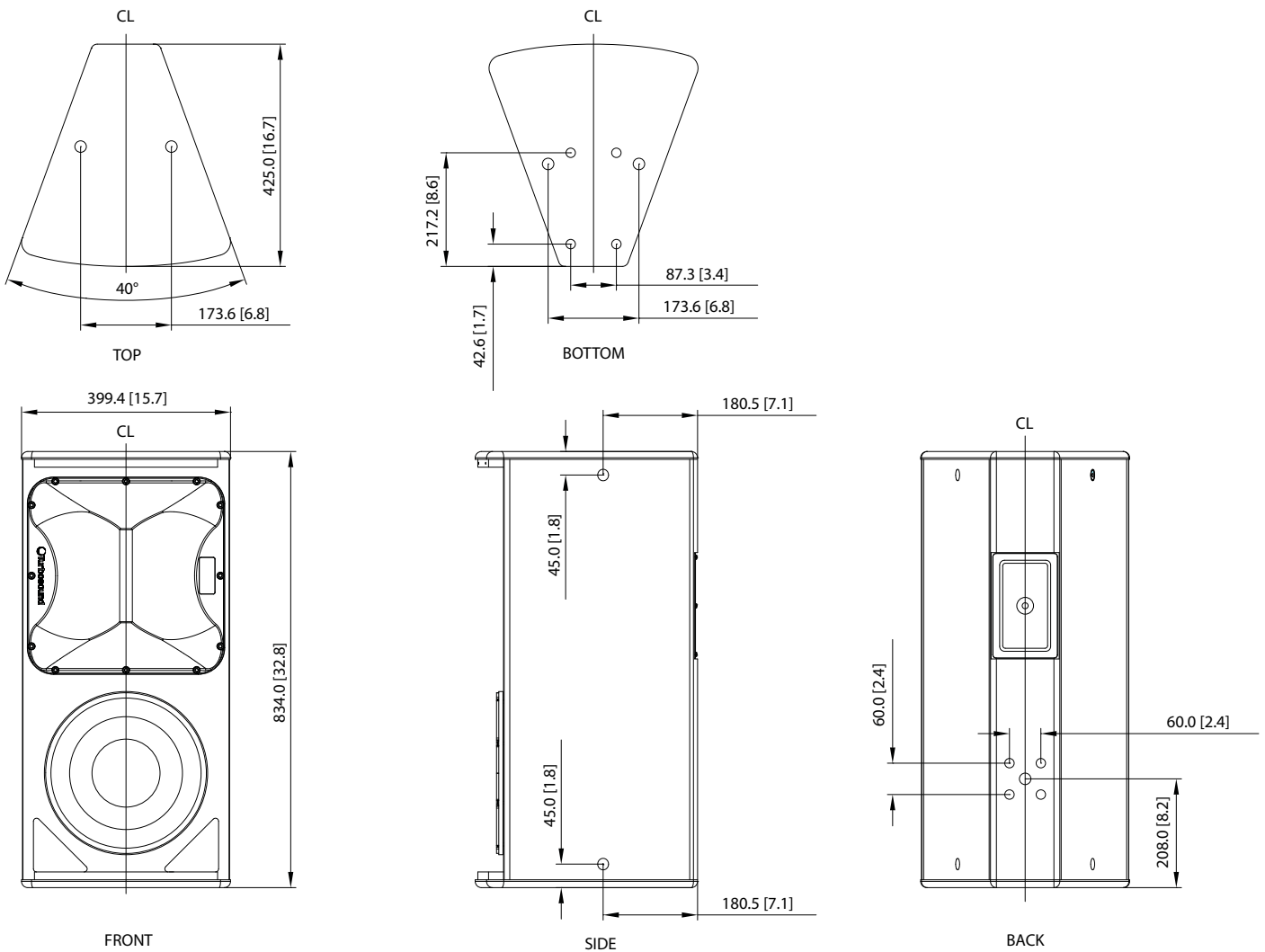

Install

ATHENS

TCS122/96-R

Arrayable 2 Way 12" Full Range Loudspeaker
with Dendritic Waveguide for Installation
Applications, 90° H x 60° V Dispersion
(Weather Resistant)

Mounting and Rigging

The cabinet is fitted with M8 x 8 and M10 x 9 internally-threaded rigging points that allow it to be rigged with optional shoulder eyebolts and mounted in many different configurations in permanent installations. The simplest method of rigging is to use the two M10 rigging points on the top, and a single pull-back rigging point in the centre of the rear panel. Adjustment of the length of the rear cable allows the cabinet to be angled for optimum room coverage.

Cabinets may also be hung upside down if required. The cabinet is compatible with industry standard wall and ceiling brackets which use 60 mm x 60 mm hole spacing.

An array of two or more cabinets can be configured using optional **TURBOSOUND** flyplates and inter-cabinet couplers. These are fixed to the cabinet sides through the M10 rigging points, and assembled together in a 'daisy chain' fashion to build up the required array. The horns of each cabinet may be rotated through 90 degrees to optimise the coverage.

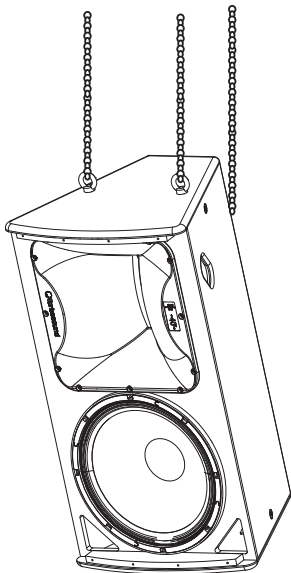

Suspension using M10 shoulder eyebolts on top and one at the rear.

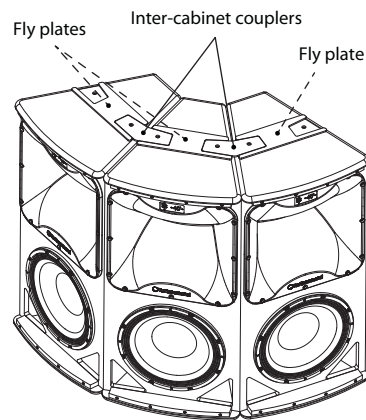

Horizontal clusters using fly plates and inter-cabinet couplers on top and bottom.

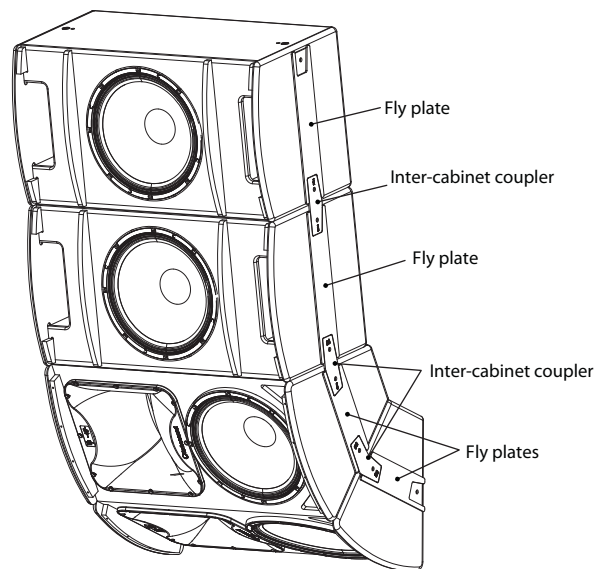

Vertical array using fly plates and inter-cabinet couplers on left and right.

Install

ATHENS

TCS122/96-R

Arrayable 2 Way 12" Full Range Loudspeaker
with Dendritic Waveguide for Installation
Applications, 90° H x 60° V Dispersion
(Weather Resistant)

Technical Specifications

System

Frequency Response	50 Hz - 18 kHz \pm 3 dB 45 Hz - 20 kHz -10 dB
Nominal Dispersion	90° H x 60° V @ -6 dB points, rotatable
Directivity Factor (Q)	8.7
Directivity Index (DI)	9.4
Power Handling (IEC)	
Passive	600 W continuous, 2400 W peak
Bi-amp	LF: 600 W continuous, 2400 W peak HF: 75 W continuous, 300 W peak
Sensitivity	96 dB (1 W @ 1 m)
Maximum SPL	
Passive	124 dB continuous, 130 dB Peak
Bi-Amp	LF: 124 dB continuous, 130 dB Peak HF: 128 dB continuous, 134 dB Peak
Impedance	
Passive	8 Ω
Bi-Amp	LF: 8 Ω HF: 6 Ω
Crossover Type	Passive / Bi-amp, internally switchable
Components	1 x 12" (312 mm) LF driver 1 x 1.4" (36 mm) HF compression driver

Enclosure

Connectors	4-core captive cable tail
Wiring	
Passive	Red/Blue input +/-, Yellow/Green NC
Bi-Amp	Red/Blue LF +/-, Yellow/Green HF +/-
Dimensions HWD	834 x 399 x 425 mm (32.8 x 15.7 x 16.7")
Net Weight	26.9 kg (59.3 lbs)
Construction	15 mm (5/8") birch plywood
Finish	Semi matt black paint
Grille	Powder-coated perforated steel
Flying Hardware	M10 x 9, M8 X 8 Points

Accessories

TCS122-FP (WH) fly plate kit for TCS122
TCS-FK1 (WH) inter-cabinet coupler kit for TCS122 or TCS152
TCS-FK2 (WH) inter-cabinet coupler kit for TCS115B with TCS122 or TCS152

Install

ATHENS

TCS122/96-R

Arrayable 2 Way 12" Full Range Loudspeaker
with Dendritic Waveguide for Installation
Applications, 90° H x 60° V Dispersion
(Weather Resistant)

Architecture & Engineering Specifications

The loudspeaker shall be of the full range, two-way, bi-amp/passive type, consisting of one 12" (312 mm) LF driver and one 1.4" (36 mm) HF compression driver. The loudspeaker shall be weather resistant for outdoor use, to rating standard IP54. Performance specifications of a typical production unit shall meet or exceed the following: frequency response, measured with swept sine wave input, shall be flat within ± 3 dB from 50 Hz to 18 kHz and within -10 dB from 45 Hz to 20 kHz. Nominal dispersion, at -6 dB points, shall average 90° H x 60° V, rotatable. Nominal impedance shall be HF: 6 Ohms, LF: 8 Ohms; passive: 8 Ohms. Power handling shall be HF: 75 Watts continuous, 300 Watts peak, LF: 600 Watts continuous, 2,400 Watts peak; passive: 600 Watts continuous, 2,400 Watts peak. Sensitivity, measured on axis, mean averaged over stated bandwidth, shall be 96 dB, 1 Watt @ 1 metre. Maximum SPL (peak), measured at 1 metre with music program at stated amplifier input, shall be HF: 134 dB, LF: 130 dB; passive: 130 dB. Dimensions: 834 mm high x 399 mm wide x 425 mm deep (32.8" x 15.7" x 16.7"). Net weight: 26.9 kg (59.3 lbs). The loudspeaker system shall be the **TURBOSOUND** TCS122/96-R. No other loudspeaker shall be acceptable unless submitted data from an independent test laboratory verifies that the above combined performance / size specifications are equaled or exceeded.

Install

ATHENS

TCS122/96-R

Arrayable 2 Way 12" Full Range Loudspeaker
with Dendritic Waveguide for Installation
Applications, 90° H x 60° V Dispersion
(Weather Resistant)

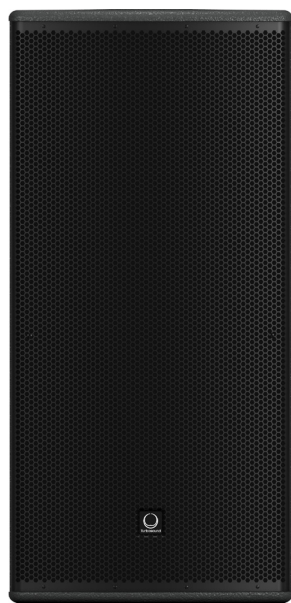

Install

ATHENS

TCS122/96-R

Arrayable 2 Way 12" Full Range Loudspeaker
with Dendritic Waveguide for Installation
Applications, 90° H x 60° V Dispersion
(Weather Resistant)

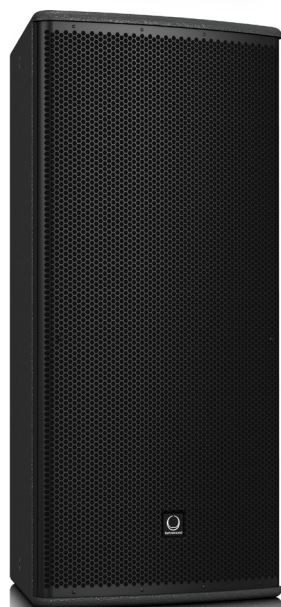
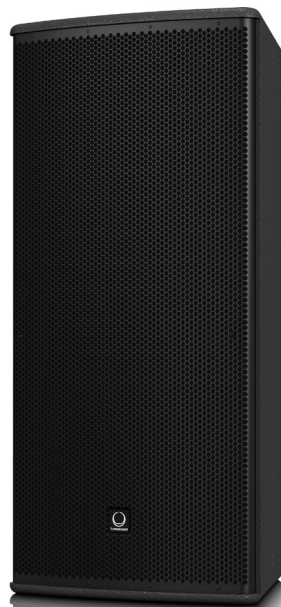

Install

ATHENS

TCS122/96-R

Arrayable 2 Way 12" Full Range Loudspeaker
with Dendritic Waveguide for Installation
Applications, 90° H x 60° V Dispersion
(Weather Resistant)



For service, support or more information contact the TURBOSOUND location nearest you:

Europe
MUSIC Tribe Brands UK Ltd.
 Tel: +44156 273 2290
 Email: CARECrea@music-group.com
 CAREEnte@music-group.com
 CARELife@music-group.com

USA/Canada
MUSIC Tribe Commercial NV Inc.
 Tel: +1 702.800 8290
 Email: CARECrea@music-group.com
 CAREEnte@music-group.com
 CARELife@music-group.com

Japan
MUSIC Tribe Services JP K.K.
 Tel: +81 3 6231 0453
 Email: CARECrea@music-group.com
 CAREEnte@music-group.com
 CARELife@music-group.com

MUSIC Tribe accepts no liability for any loss which may be suffered by any person who relies either wholly or in part upon any description, photograph, or statement contained herein. Technical specifications, appearances and other information are subject to change without notice. All trademarks are the property of their respective owners. MIDAS, KLARK TEKNIK, LAB GRUPPEN, LAKE, TANNOY, TURBOSOUND, TC ELECTRONIC, TC HELICON, BEHRINGER, BUGERA and COOLAUDIO are trademarks or registered trademarks of MUSIC Tribe Global Brands Ltd. © MUSIC Tribe Global Brands Ltd. 2018 All rights reserved.