

Install Speakers

ATHENS TCS110B-WH

10" Band Pass Subwoofer for
Installation Applications (White)

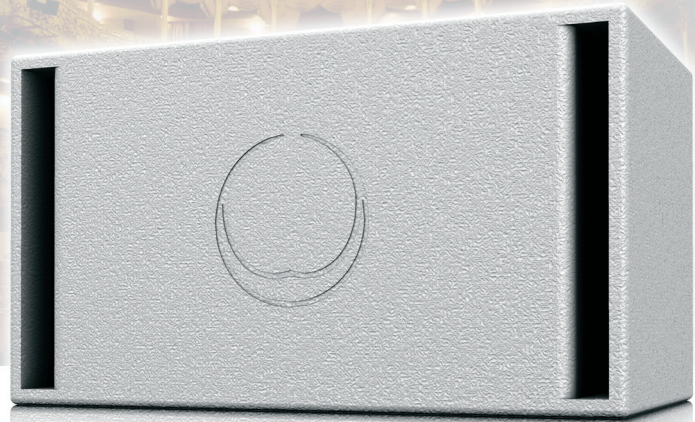

- Band pass subwoofer for installation applications
- 300 Watts continuous, 1,200 Watts peak power
- High excursion 10" low frequency driver with inside/outside wound coil
- Low distortion dual port design for maximum sound pressure level
- 15 mm (5/8") birch plywood enclosure with hard wearing semi matt white paint finish
- Integral M10 rigging points for ease of installation
- Neutrik speakON* NL4 and barrier strip connectors
- 3-Year Warranty Program*
- Designed and engineered in England

The 1,200-Watt TCS110B-WH is a high performance 10" subwoofer system designed for a wide range of speech and music sound reinforcement applications. Engineered to work in conjunction with **TURBOSOUND** loudspeaker management systems, the TCS110B-WH provides extended low frequency performance from a compact enclosure.



A dual port design enclosure, the TCS110B-WH features an extremely powerful, high excursion 10" low frequency driver with a specialised voice coil wound on both the inside and outside of the coil former for higher magnetic density, heat dissipation, higher power handling capacity, and improved efficiency. The TCS110B-WH provides fast and accurate transient response for virtually distortion-free operation – even in your most demanding performances.

Finished in a highly durable semi matt white paint, the cabinet is constructed from 15 mm (5/8") birch plywood with integral **M10** threaded rigging points. The rear panel connector plate carries Neutrik speakON* NL4 and barrier strip connectors for input and link connections to additional enclosures.

Install Speakers

ATHENS TCS110B-WH

10" Band Pass Subwoofer for
Installation Applications (White)



You Are Covered

We always strive to provide the best possible Customer Experience. Our products are made in our own [MUSIC Group](#) factory using state-of-the-art automation, enhanced production workflows and quality assurance labs with the most sophisticated test equipment available in the world. As a result, we have one of the lowest product failure rates in the industry, and we confidently back it up with a generous [3-Year Warranty program](#).

Install Speakers

ATHENS TCS110B-WH

10" Band Pass Subwoofer for
Installation Applications (White)

Frequency Response Sensitivity 1 W / 1 m

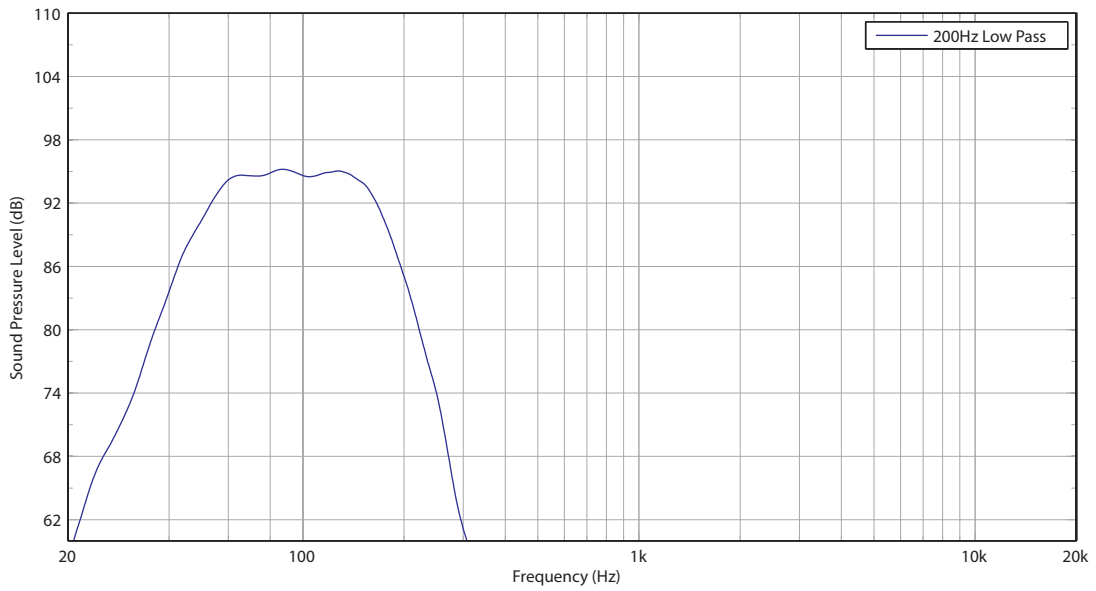

Impedance

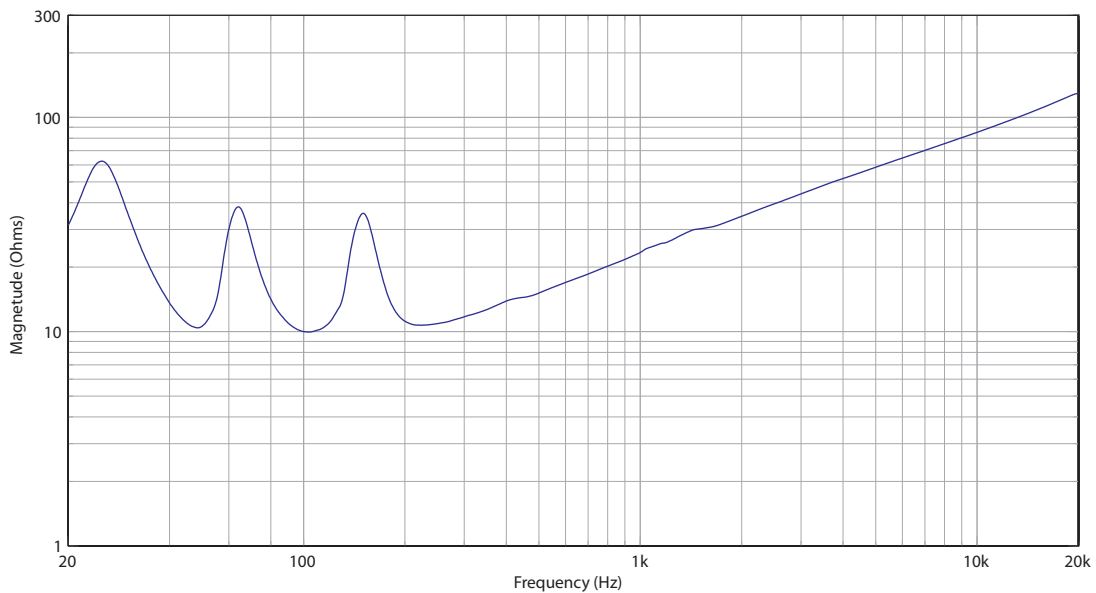

Install Speakers

ATHENS TCS110B-WH

10" Band Pass Subwoofer for
Installation Applications (White)

Dimensions

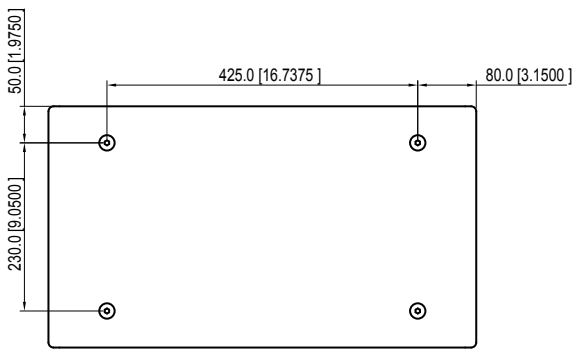

TOP

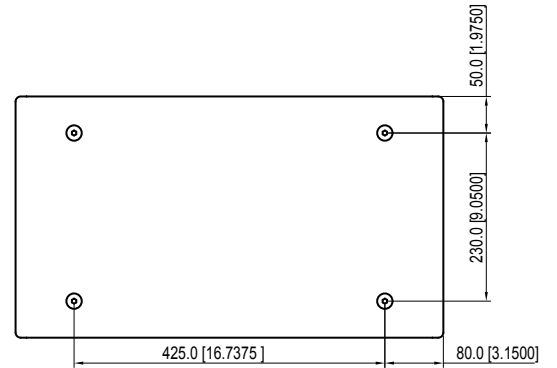

BOTTOM

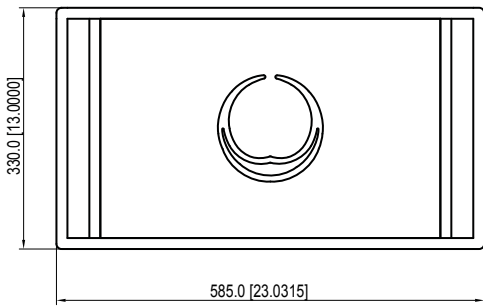

FRONT

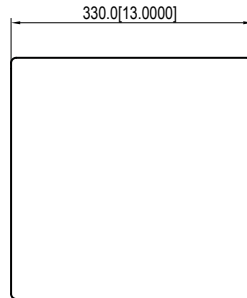

SIDE

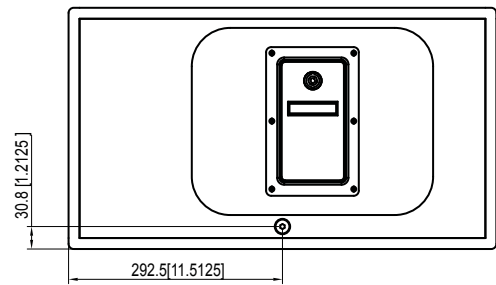

REAR

Install Speakers

ATHENS TCS110B-WH

10" Band Pass Subwoofer for
Installation Applications (White)

Technical Specifications

System

| | |
|----------------------|--|
| Frequency Response | 50 Hz - 150 Hz \pm 3 dB 40 Hz - 200 Hz -10 dB |
| Nominal Dispersion | Half space |
| Power Handling (IEC) | 300 W continuous, 1200 W peak |
| Sensitivity | 94 dB (1 W @ 1 m) |
| Maximum SPL | 119 dB continuous, 125 dB peak |
| Impedance | 8 Ω |
| Components | 1 x 10" (262 mm) LF driver |

Enclosure

| | |
|-----------------|---|
| Connectors | 1 x Neutrik speakON* NL4, 1 x barrier strip terminals |
| Wiring | Parallel / No switch Pins 1+ / 1- input, pins 2+ / 2- link |
| Discrete | — |
| Dimensions HWD | 330 x 585 x 330 mm (13.0 x 23.0 x 13.0") |
| Net Weight | 15.8 kg (34.8 lbs) |
| Construction | 15 mm (5/8") birch plywood |
| Finish | Semi matt white paint |
| Grille | Powder-coated perforated steel |
| Flying Hardware | M10 x 8 |

Install Speakers

ATHENS TCS110B-WH

10" Band Pass Subwoofer for
Installation Applications (White)

Architecture & Engineering Specifications

The speaker shall be of the passive subwoofer type consisting of one 10" (262 mm) LF driver. Performance specifications of a typical production unit shall meet or exceed the following: frequency response, measured with swept sine wave input, shall be flat within ± 3 dB from 50 Hz to 150 Hz and within -10 dB from 40 Hz to 200 Hz. Nominal dispersion shall be "half space." Nominal impedance shall be 8 Ohms. Power handling shall be 300 Watts continuous, 1,200 Watts peak. Sensitivity, measured on axis, mean averaged over stated bandwidth, shall be 94 dB, 1 Watt @ 1 metre. Maximum SPL (peak), measured at 1 metre with music program at stated amplifier input, shall be 125 dB. Dimensions: 330 mm high x 585 mm wide x 330 mm deep (13.0" x 23.0" x 13.0"). Net weight: 15.8 kg (34.8 lbs). The loudspeaker system shall be the [TURBOSOUND TCS110B-WH](#). No other loudspeaker shall be acceptable unless submitted data from an independent test laboratory verifies that the above combined performance / size specifications are equaled or exceeded.

Install Speakers

ATHENS TCS110B-WH

10" Band Pass Subwoofer for
Installation Applications (White)

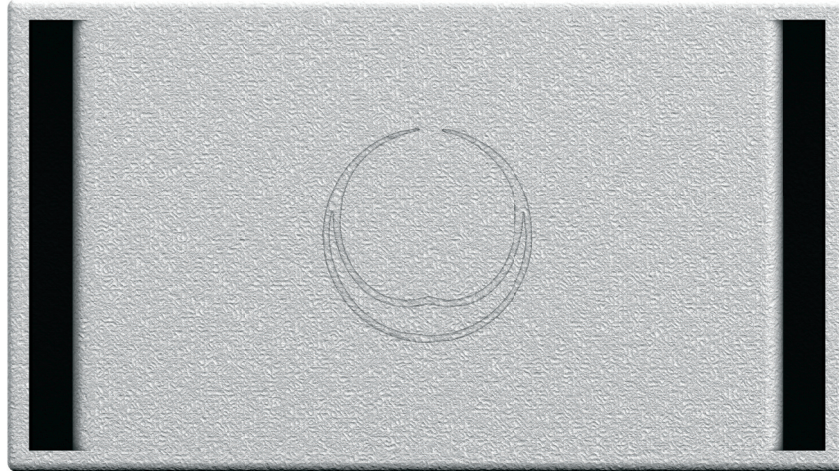

Install Speakers

ATHENS TCS110B-WH

10" Band Pass Subwoofer for
Installation Applications (White)



Install Speakers

ATHENS TCS110B-WH

10" Band Pass Subwoofer for
Installation Applications (White)



For service, support or more information contact the TURBOSOUND location nearest you:

Europe
MUSIC Group Services UK
 Tel: +44 156 273 2290
 Email: CARE@music-group.com

USA/Canada
MUSIC Group Services NV Inc.
 Tel: +1 702 800 8290
 Email: CARE@music-group.com

Japan
MUSIC Group Services JP K.K.
 Tel: +81 3 6231 0454
 Email: CARE@music-group.com

MUSIC Group accepts no liability for any loss which may be suffered by any person who relies either wholly or in part upon any description, photograph, or statement contained herein. Technical specifications, appearances and other information are subject to change without notice. All trademarks are the property of their respective owners. MIDAS, KLARK TEKNIK, LAB GRUPPEN, LAKE, TANNØY, TURBOSOUND, TC ELECTRONIC, TC HELICON, BEHRINGER, BUGERA and DDA are trademarks or registered trademarks of MUSIC Group IP Ltd.
 © MUSIC Group IP Ltd. 2016 All rights reserved.

