

## Install

# IMPACT TCI53-T-WH

Pair of Dual 2 Way 5" Full Range Loudspeakers with Line Transformers for Installation Applications (White)

- Pair of compact 2 way full range surface-mount loudspeakers for installation applications
- 120 Watts continuous, 480 Watts peak power
- High excursion 5" low frequency driver with high temperature voice coil
- Dual 1" ferrofluid cooled neodymium high frequency drivers
- Multiple transformer taps for 70 V and 100 V line systems or 8 Ohm direct input
- Proprietary elliptical waveguide provides wide 100° H x 70° V dispersion
- Wall-mount bracket with integral loudspeaker connections included
- Architecturally styled glass filled impact resistant enclosure
- Semi matt white finish fits unobtrusively in any environment
- 2 x M6 rigging points compatible with TURBOSOUND and OmniMount\* brackets
- 3/8" mic stand fitting for spot monitor applications
- 10-Year Warranty Program\*
- Designed and engineered in the U.K.

Shipped in pairs, the ultra-compact IMPACT TCI53-T-WH is a passive two way surface-mount loudspeaker that is ideally suited for a wide range of installed speech and music applications. With a power handling capacity of 240 Watts, the system consists of dual high excursion 5" low frequency drivers with a high temperature voice coil, and dual 1" neodymium ferro-fluid cooled high frequency drivers mated to a proprietary elliptical waveguide – for a wide 100° horizontal by 70° vertical dispersion pattern.



## Custom-Engineered Drivers

TURBOSOUND is recognised the world over for designing and building some of the most iconic loudspeakers and subwoofers in the industry. We take meticulous care and pride in maintaining that reputation by utilising only drivers designed specifically for each application – it's what sets us apart from the competition. The custom designed high excursion 5" low frequency and 1" neodymium high frequency drivers ensure truly world-class performance that will deftly stand the test of time

## Install

# IMPACT

## TCI53-T-WH

Pair of Dual 2 Way 5" Full Range  
Loudspeakers with Line Transformers  
for Installation Applications (White)

### Internal Transformer

The TCI53-T-WH includes an internal line transformer with multiple taps for use in 70 and 100 Volt line distributed sound applications, as well as a direct 8 Ohm input for use with low-impedance amplifiers. Taps are provided at 120, 60, and 30 Watts on the 100 V line; 120, 60, 30, and 15 Watts on the 70 V line.



### Discreet Implementation

When permanently installed, the architecturally styled, glass filled and impact resistant TCI53-T-WH enclosure sports a classic semi matt white finish, which allows it to fit unobtrusively and elegantly into any environment. The included integral wall mounting bracket provides hidden cable management, completing the seamless visual presentation.

### Installation and Connectivity

The TCI53-T-WH is supplied with an adjustable wall mounting bracket that also provides the loudspeaker connections, allowing the brackets alone to be sited, installed, and wired in the early stages of building construction or remodelling – making final installation a greatly simplified and cost effective process. Threaded internal M6 rigging points are also provided for installation with **TURBOSOUND** wall and ceiling hardware, as well as industry standard brackets. A convenient  $\frac{3}{8}$ " mic stand fitting, hidden under the EPDM rubber cover on the bottom of the cabinet, allows affixing the TCI53-T-WH to a standard microphone stand for use as a 'spot monitor'.

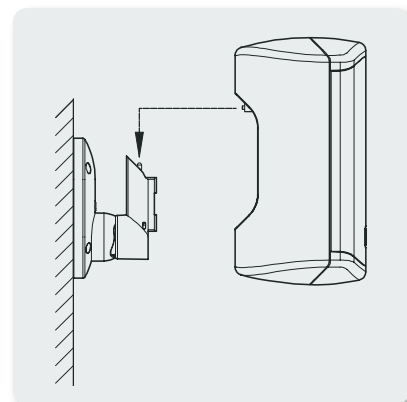

Install

# IMPACT

## TCI53-T-WH

Pair of Dual 2 Way 5" Full Range  
Loudspeakers with Line Transformers  
for Installation Applications (White)



### You Are Covered

We always strive to provide the best possible Customer Experience. Our products are made in our own [MUSIC Tribe](#) factory using state-of-the-art automation, enhanced production workflows and quality assurance labs with the most sophisticated test equipment available in the world. As a result, we have one of the lowest product failure rates in the industry, and we confidently back it up with a generous [Warranty program](#).

Install

# IMPACT

## TCI53-T-WH

Pair of Dual 2 Way 5" Full Range Loudspeakers with Line Transformers for Installation Applications (White)

### Frequency Response Sensitivity 1 W / 1 m

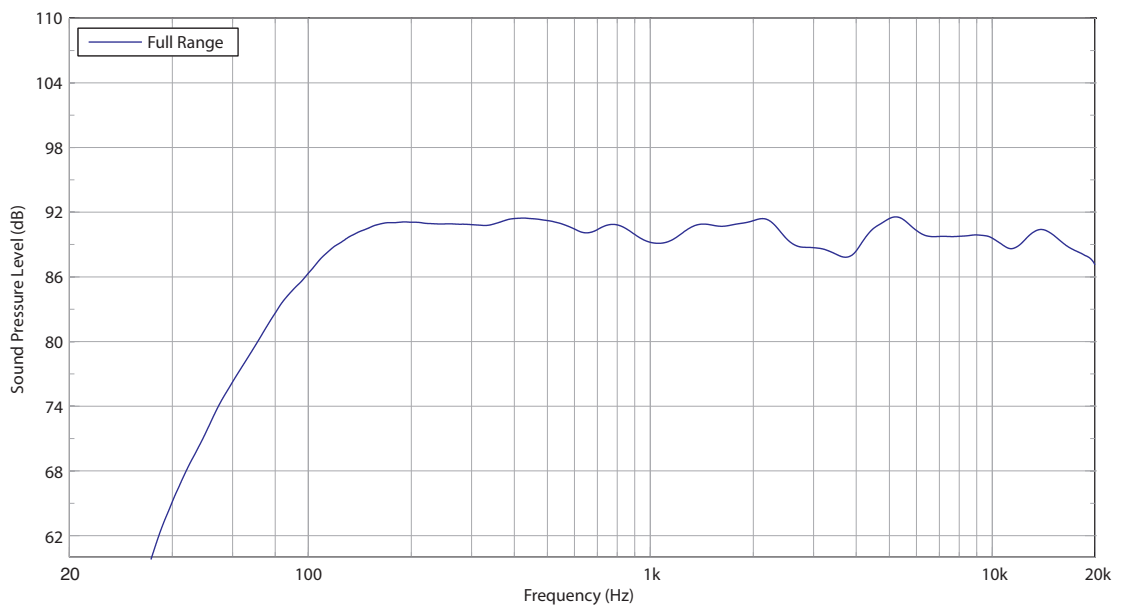

### Impedance

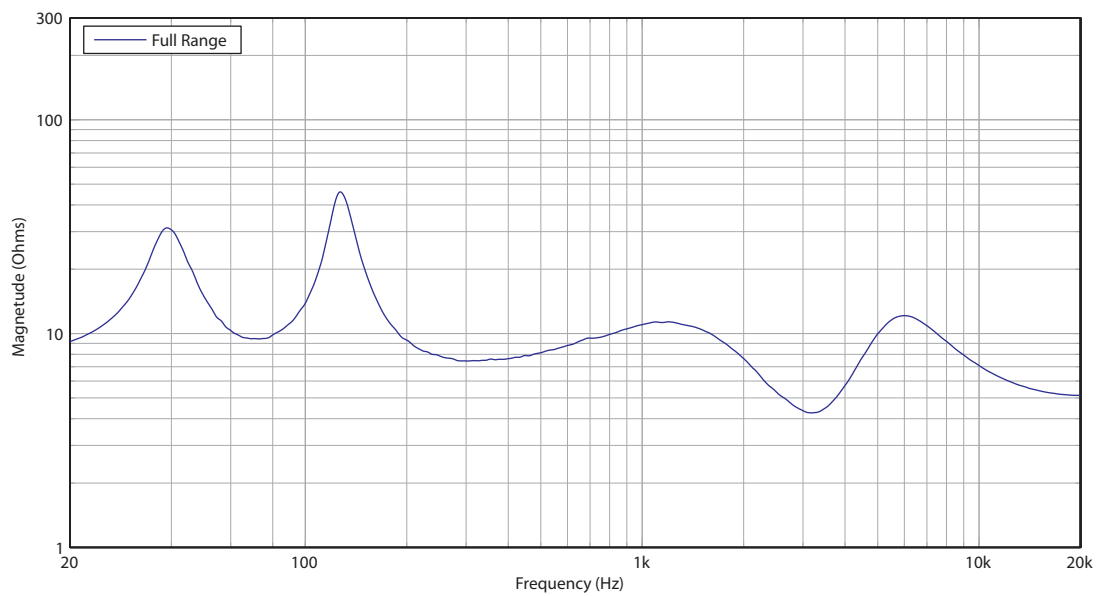

Install

# IMPACT

## TCI53-T-WH

Pair of Dual 2 Way 5" Full Range Loudspeakers with Line Transformers for Installation Applications (White)

### Horizontal Beamwidth

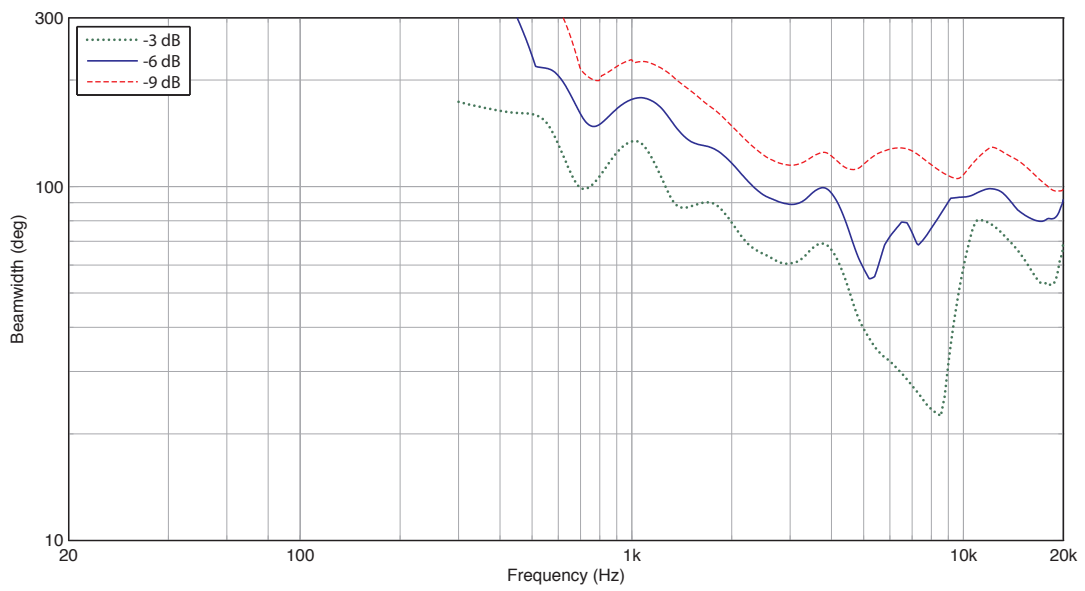

### Vertical Beamwidth

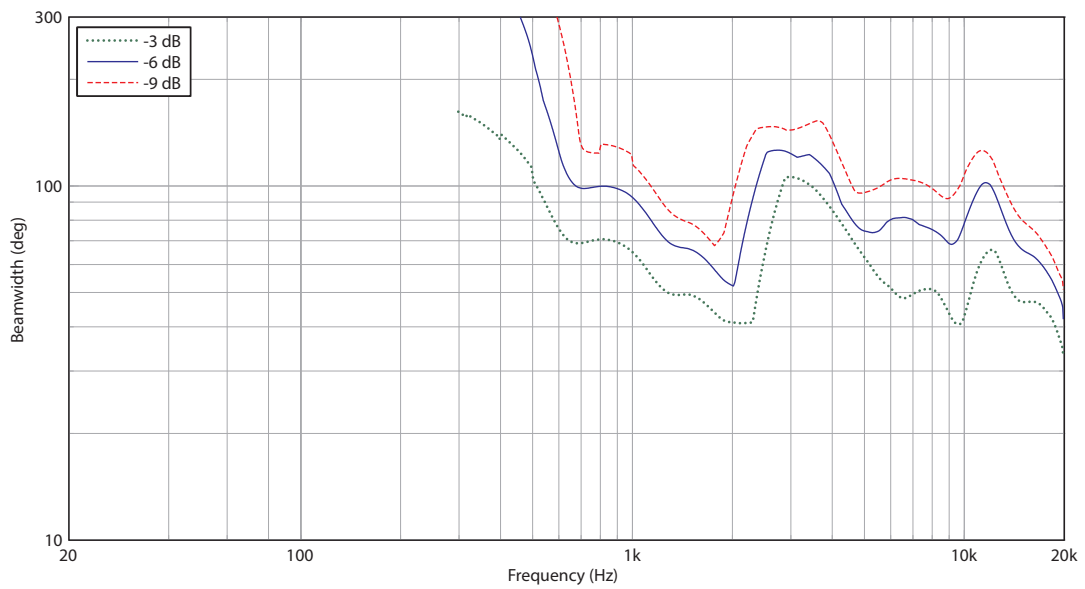

Install

# IMPACT

## TCI53-T-WH

Pair of Dual 2 Way 5" Full Range  
Loudspeakers with Line Transformers  
for Installation Applications (White)

### Horizontal Polar Plots

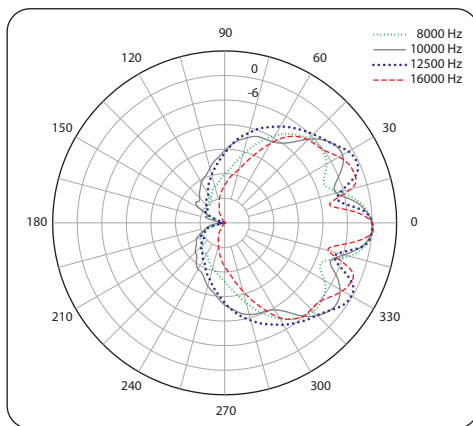
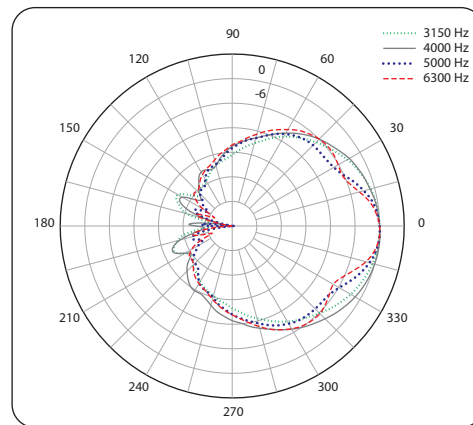
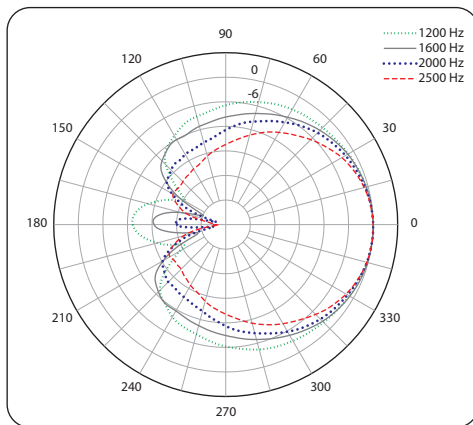
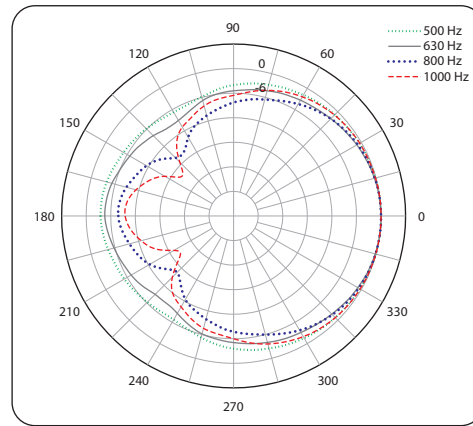
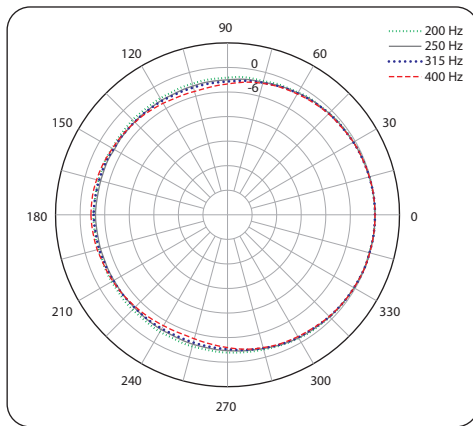



Install

# IMPACT TCI53-T-WH

Pair of Dual 2 Way 5" Full Range  
Loudspeakers with Line Transformers  
for Installation Applications (White)

## Vertical Polar Plots

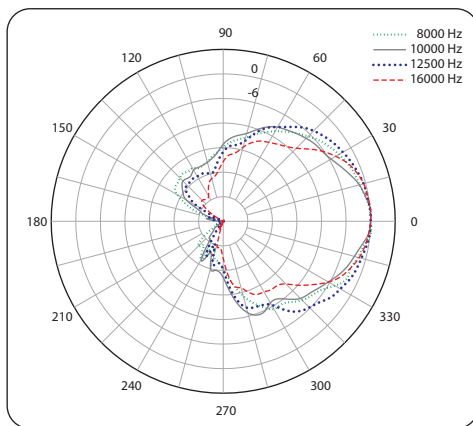
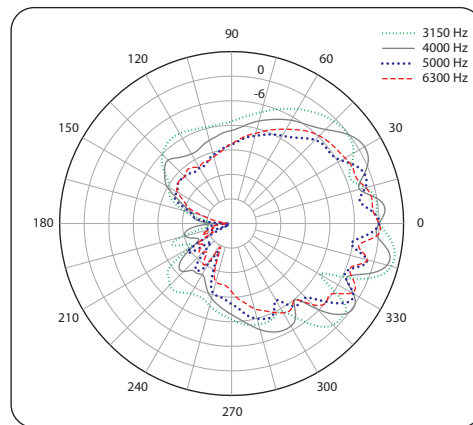
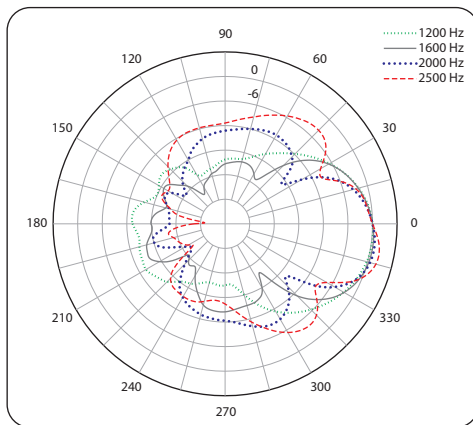
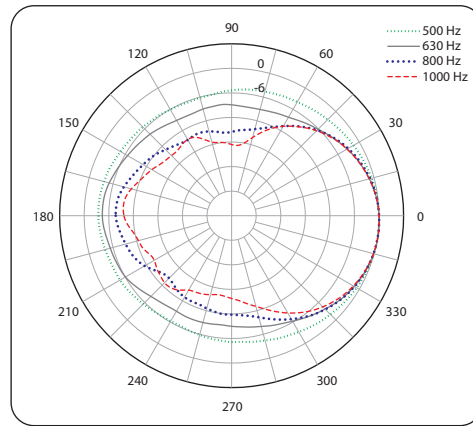
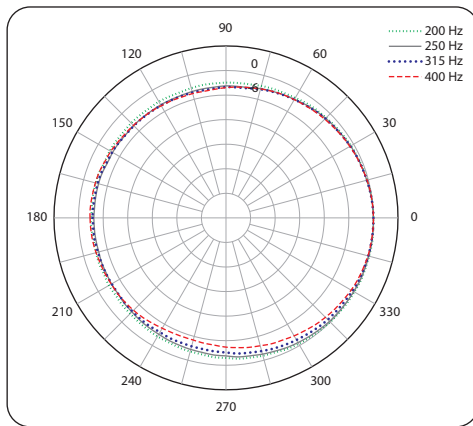

Install

# IMPACT

## TCI53-T-WH

Pair of Dual 2 Way 5" Full Range  
Loudspeakers with Line Transformers  
for Installation Applications (White)

### Dimensions

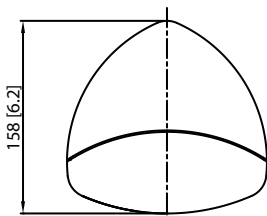

TOP

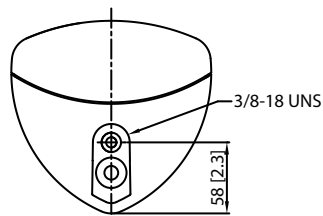

BOTTOM

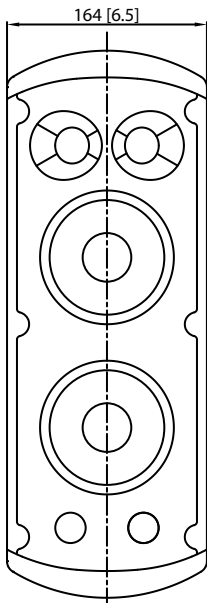

CL  
FRONT

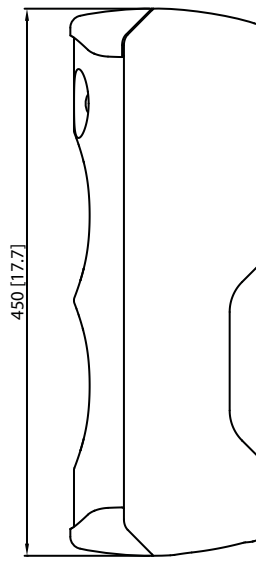

SIDE

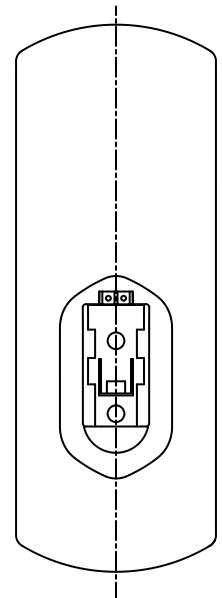

REAR



## Install

# IMPACT

## TCI53-T-WH

Pair of Dual 2 Way 5" Full Range  
Loudspeakers with Line Transformers  
for Installation Applications (White)

## Technical Specifications

### System

<b>Frequency response</b>	74 Hz - 18 kHz $\pm$ 3 dB 43 Hz - 20 kHz -10 dB
<b>Nominal dispersion</b>	100° H x 70° V @ -6 dB points
<b>Power handling (IEC)</b>	
Passive	120 W continuous, 480 W peak
100 V line	120, 60, 30 W continuous
70 V line	120, 60, 30, 15 W continuous
<b>Sensitivity</b>	90 dB (1 W @ 1 m)
<b>Maximum SPL</b>	
Passive	111 dB continuous, 117 dB peak
100 V line	117, 114, 111 dB peak
70 V line	117, 114, 111, 105 dB peak
<b>Impedance</b>	8 $\Omega$
<b>Components</b>	2 x 5" (127 mm) LF driver 2 x 1" (25 mm) HF soft dome driver

### Enclosure

<b>Connectors</b>	Screw terminal block
<b>Wiring</b>	Input +VE, -VE
<b>Dimensions HWD</b>	450 x 164 x 158 mm (17.7 x 6.5 x 6.2")
<b>Net weight</b>	5.0 kg (11.0 lbs)
<b>Construction</b>	Gas injected, glass-filled moulded ABS enclosure
<b>Finish</b>	White (black optional)
<b>Grille</b>	Powder coated perforated steel
<b>Flying hardware</b>	M6 x 2 points

### Accessories

Wall bracket - included

## Install

# IMPACT TCI53-T-WH

Pair of Dual 2 Way 5" Full Range  
Loudspeakers with Line Transformers  
for Installation Applications (White)

## Architecture & Engineering Specifications

The system shall be of the passive two-way type consisting of two 5" (127 mm) low frequency drivers and two 1" (25 mm) ferro-fluid cooled neodymium high frequency tweeters with integral line transformer and shall be supplied with an adjustable wall bracket providing integral electrical connections. Performance specifications of a typical production unit shall meet or exceed the following: Frequency response, measured with swept sine wave input, shall be flat within  $\pm 3$  dB from 74 Hz to 18 kHz, and within -10 dB from 43 Hz to 20 kHz. Nominal dispersion, at -6 dB points, shall average  $100^\circ$  H x  $70^\circ$  V. Nominal impedance shall be 8 ohms. Power handling shall be 120 watts continuous, 480 Watts peak. Sensitivity, measured with 1 Watt input at 1 metre distance on axis, mean averaged over stated bandwidth shall be 90 dB. Maximum SPL (peak) measured with music program input at stated amplifier power shall be 117 dB. Dimensions: 450 mm high x 164 mm wide x 158 mm deep (17.7" x 6.5" x 6.2"). Net weight: 5.0 kg (11.0 lbs). The loudspeaker system shall be the [TURBOSOUND IMPACT TCI53-T-WH](#). No other loudspeaker shall be acceptable unless submitted data from an independent test laboratory verifies that the above combined performance / size specifications are equalled or exceeded.

Install

# IMPACT

## TCI53-T-WH

Pair of Dual 2 Way 5" Full Range  
Loudspeakers with Line Transformers  
for Installation Applications (White)



Install

# IMPACT

## TCI53-T-WH

Pair of Dual 2 Way 5" Full Range  
Loudspeakers with Line Transformers  
for Installation Applications (White)

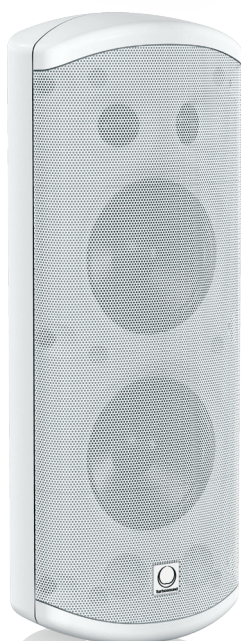
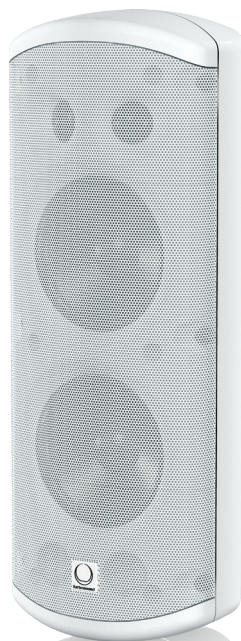

Install

# IMPACT TCI53-T-WH

Pair of Dual 2 Way 5" Full Range  
Loudspeakers with Line Transformers  
for Installation Applications (White)



For service, support or more information contact the TURBOSOUND location nearest you:

**Europe**  
**MUSIC Tribe Brands UK Ltd.**  
Tel: +44156 273 2290  
Email: CARECrea@music-group.com  
CAREEnte@music-group.com  
CARELife@music-group.com

**USA/Canada**  
**MUSIC Tribe Commercial NV Inc.**  
Tel: +1 702.800 8290  
Email: CARECrea@music-group.com  
CAREEnte@music-group.com  
CARELife@music-group.com

**Japan**  
**MUSIC Tribe Services JP K.K.**  
Tel: +81 3 6231 0453  
Email: CARECrea@music-group.com  
CAREEnte@music-group.com  
CARELife@music-group.com

MUSIC Tribe accepts no liability for any loss which may be suffered by any person who relies either wholly or in part upon any description, photograph, or statement contained herein. Technical specifications, appearances and other information are subject to change without notice. All trademarks are the property of their respective owners. MIDAS, KLARK TEKNIK, LAB GRUPPEN, LAKE, TANNÖY, TURBOSOUND, TC ELECTRONIC, TC HELICON, BEHRINGER, BUGERA and COOLAUDIO are trademarks or registered trademarks of MUSIC Group IP Ltd. © MUSIC Group IP Ltd. 2018 All rights reserved.