

Portable Speakers

NuQ

NuQ82-AN

600 Watt 2 Way 8" Full Range
Powered Loudspeaker with
KLARK TEKNIK DSP Technology and
ULTRANET Networking

- 2 way full range powered loudspeaker for portable PA and installation applications
- 600 Watt power featuring KLARK TEKNIK Class-D technology
- KLARK TEKNIK Digital Signal Processing for total system control
- ULTRANET digital audio networking connects to mixers and other sources
- 8" low frequency driver with low mass voice coil for improved transient response
- Aluminium dome 1" neodymium motor compression driver
- Rotatable converging elliptical waveguide provides 100° H x 60° V dispersion
- Fully featured user interface with LCD display for ease of navigation
- PC remote control software downloadable at turbosound.com
- 12 mm (1/2") birch plywood enclosure with hard wearing semi matt black paint finish
- Rugged powder coated perforated steel mesh grille
- Integral 35 mm pole mount and handles
- Multiple internal rigging points allow bracket mount and suspension in any orientation
- Mains input on Neutrik powerCON* connector
- 3-Year Warranty Program*
- Designed and engineered in England

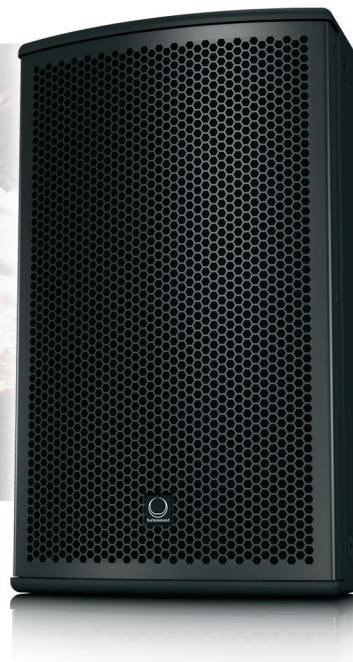

The 2-way full range NuQ82-AN is a 600 Watt 8" powered loudspeaker system that is ideally suited for a wide range of portable and fixed installation speech and music sound reinforcement applications. Designed to work individually without a controller, the NuQ82-AN provides optimal performance for FOH, sidefill and delay line loudspeakers, and is an exceptional choice for wedge monitoring applications. It also offers the flexibility to accommodate venue-specific requirements for install applications.



The NuQ82-AN loudspeaker features an 8" low frequency driver with a low mass voice coil for improved transient response and an aluminium dome 1" neodymium high frequency compression driver, which is mounted on a rotatable 100° horizontal by 60° vertical dispersion converging elliptical waveguide.

Output power for the NuQ82-AN is provided by means of an efficient and lightweight KLARK TEKNIK 600-Watt Class-D power amplifier. A sophisticated, but easy to use KLARK TEKNIK Digital Signal Processor (DSP) provides dynamic EQ for impressive full range response at low volume levels and transparent limiting for clarity at high output levels – and for long-term reliability.

Portable Speakers

NuQ

NuQ82-AN

600 Watt 2 Way 8" Full Range
Powered Loudspeaker with
KLARK TEKNIK DSP Technology and
ULTRANET Networking

On the rear panel of the amplifier module, the user interface's LCD display and single rotary encoder provide intuitive access to: position compensation, user EQ control, subwoofer integration and signal routing features. In addition to the balanced XLR input, an XLR output is provided for daisy-chaining more active loudspeakers or for use with active subwoofers. An onboard USB port provides access for remote control of the NuQ82-AN via PC computer, as well as DSP firmware updates.

ULTRANET connectivity is provided by two locking etherCON* connectors. Up to 16 independent channels of 24-bit digital audio and control data are transmitted via a single CAT5 cable between compatible digital devices – including mixers, I/O stage boxes, powered loudspeakers and personal monitoring systems. Simplified cable routing and ease of setup translate directly into significant time saved during installation.

Finished in a highly durable semi matt black paint, the trapezoidal cabinet is constructed from 12 mm (½") birch plywood – and includes a rugged powder coated perforated steel mesh grille. Multiple threaded rigging points are provided for suspension in any orientation. The [NuQ82-FY](#) flying yoke kit, [NuQ82-SB](#) swivel bracket, and [NuQ82-EB](#) swivel extender provide added flexibility in permanent install applications (available separately). The NuQ82-AN also features a 35 mm socket for standard pole mounting – plus integrated handles for convenient transport. Mains power input is provided via a Neutrik powerCON* connector.

Portable Speakers

NuQ

NuQ82-AN

600 Watt 2 Way 8" Full Range
Powered Loudspeaker with
KLARK TEKNIK DSP Technology and
ULTRANET Networking

Frequency Response Sensitivity 1 W / 1 m

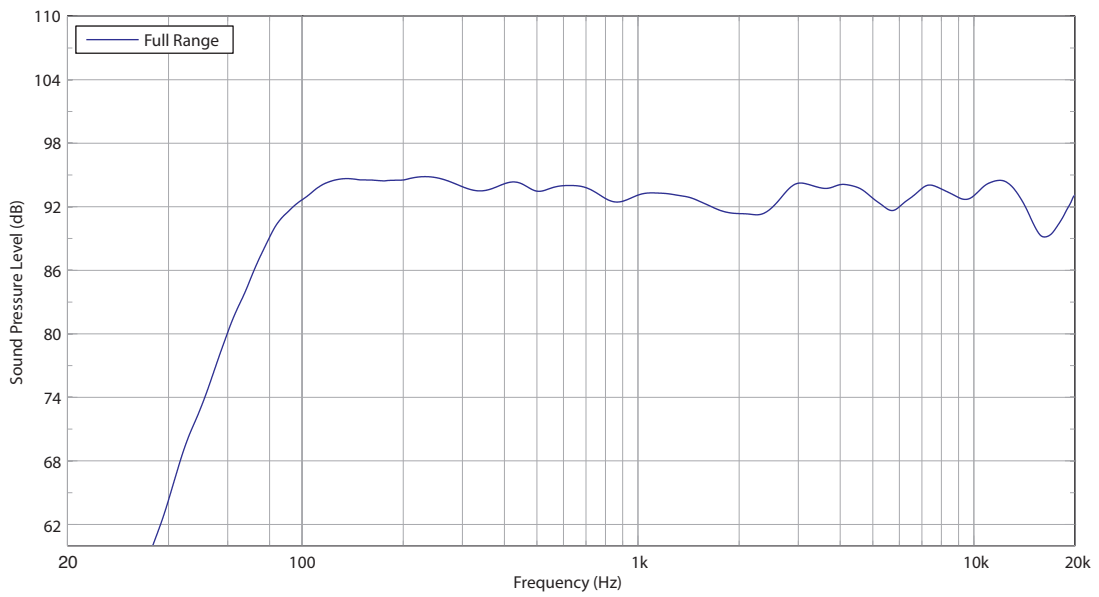

Portable Speakers

NuQ

NuQ82-AN

600 Watt 2 Way 8" Full Range
Powered Loudspeaker with
KLARK TEKNIK DSP Technology and
ULTRANET Networking

Horizontal Beamwidth

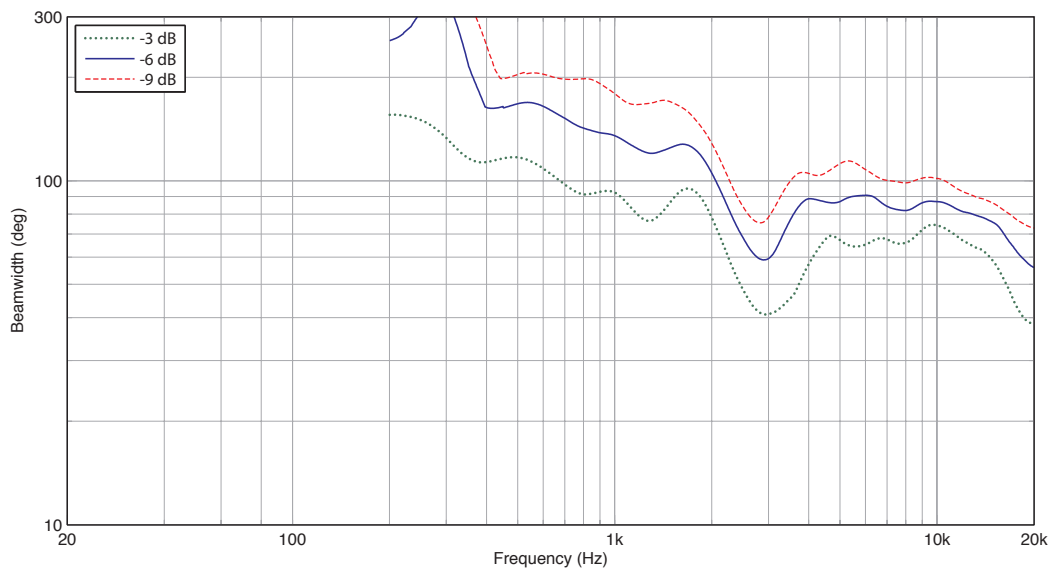

Vertical Beamwidth

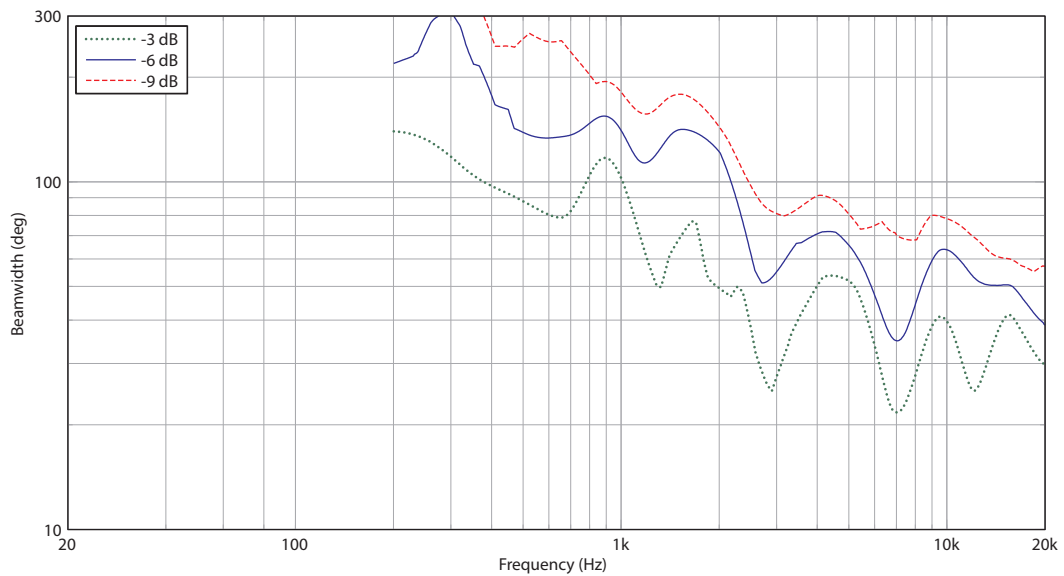

Portable Speakers

NuQ NuQ82-AN

600 Watt 2 Way 8" Full Range
Powered Loudspeaker with
KLARK TEKNIK DSP Technology and
ULTRANET Networking

Horizontal Polar Plots

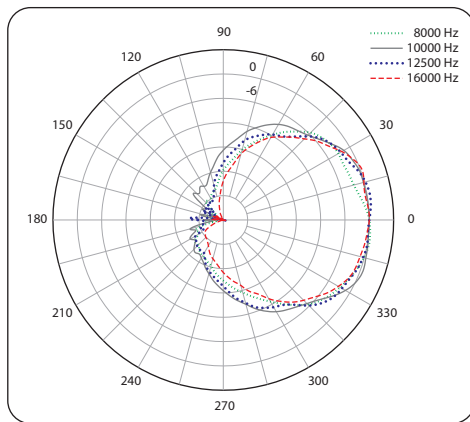
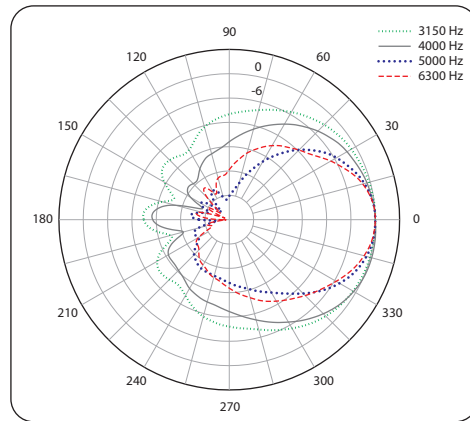
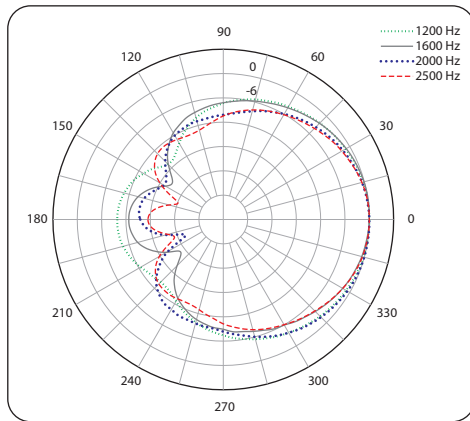
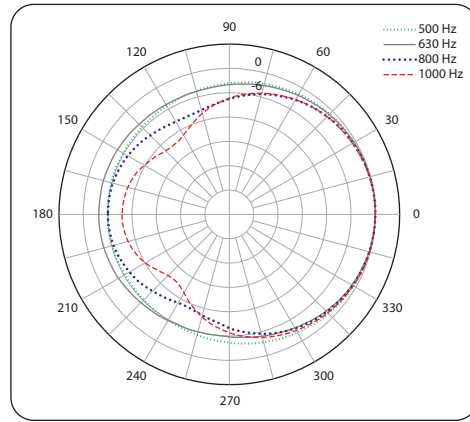
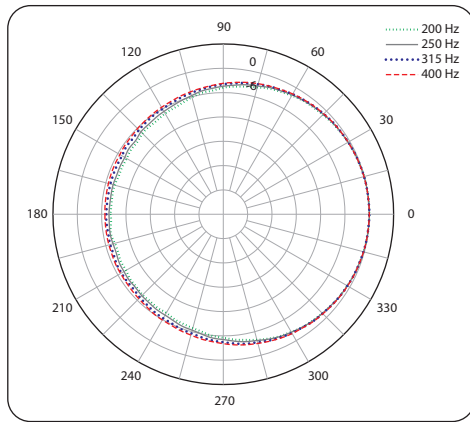

Portable Speakers

NuQ

NuQ82-AN

600 Watt 2 Way 8" Full Range
Powered Loudspeaker with
KLARK TEKNIK DSP Technology and
ULTRANET Networking

Vertical Polar Plots

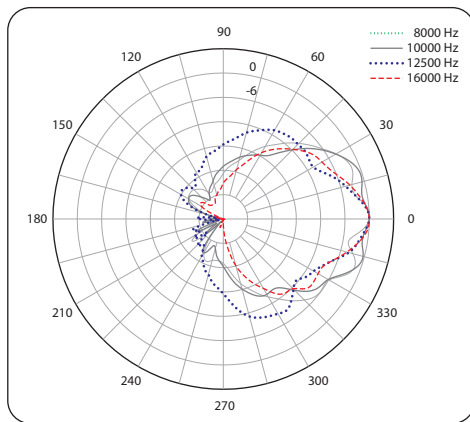
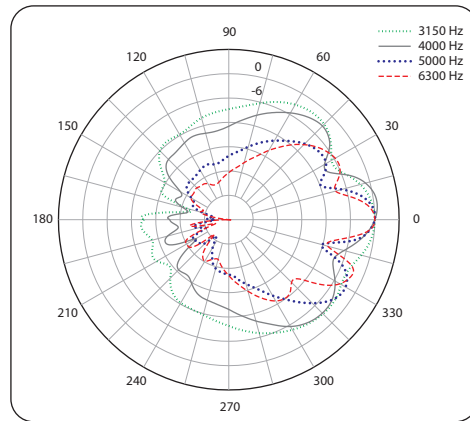
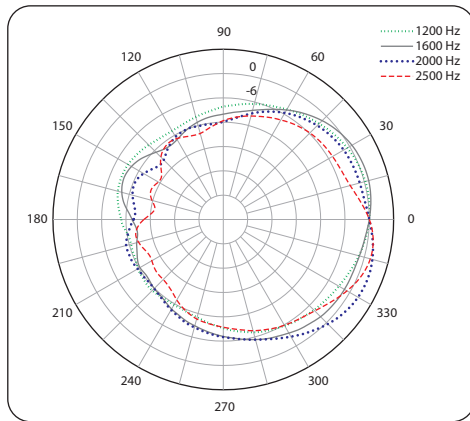
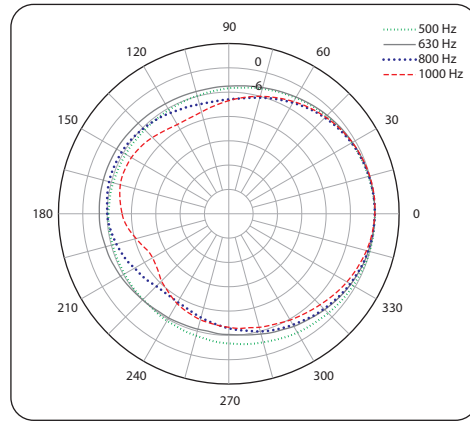
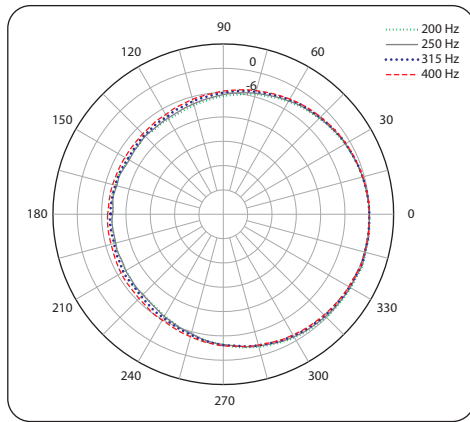

Portable Speakers

NuQ

NuQ82-AN

600 Watt 2 Way 8" Full Range
Powered Loudspeaker with
KLARK TEKNIK DSP Technology and
ULTRANET Networking

Dimensions

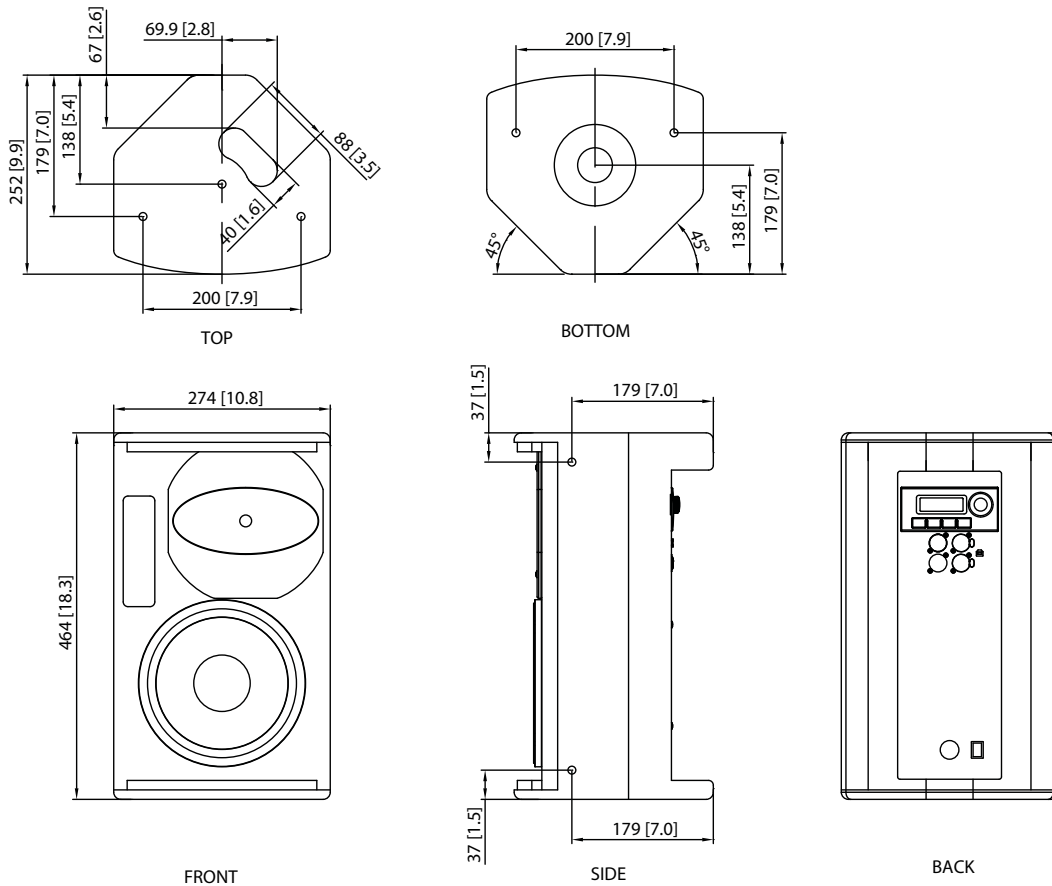

Portable Speakers

NuQ

NuQ82-AN

600 Watt 2 Way 8" Full Range
Powered Loudspeaker with
KLARK TEKNIK DSP Technology and
ULTRANET Networking

Mounting and Rigging

The cabinet is fitted with M10 x 8 and M8 x 1 internally-threaded rigging points that allow it to be rigged with optional shoulder eyebolts and mounted in many different configurations in permanent installations. The simplest method of rigging is to use the two M10 rigging points on the top. Cabinets may also be hung upside down if required.

The cabinet has an integral 35 mm pole mount socket in the bottom panel, that allows it to be pole mounted.

The optional [NuQ82-SB](#) swivel bracket allows the cabinet to be surface mounted and angled for optimum positioning and coverage. The [NuQ82-EB](#) extender bracket allows cabinets to be arrayed, and the [NuQ82-FY](#) fly yoke adds further installation flexibility for scaffold, surface, and pole mounting.

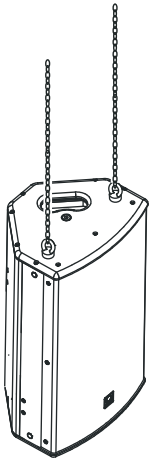

Suspension using M10
shoulder eyebolts

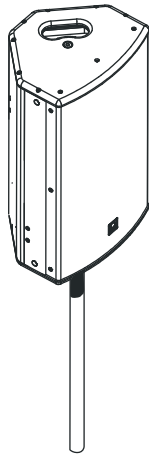

Mounting on 35 mm
pole or speaker stand

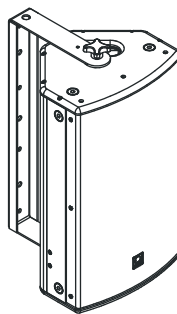

NuQ82-SB swivel
bracket for surface
mounting

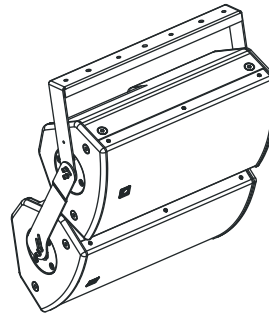

NuQ82-SB bracket
with NuQ82-EB
extender brackets,
creating an array

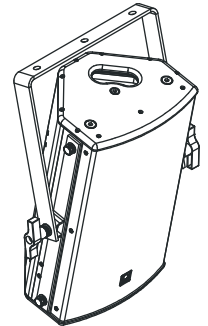

NuQ82-FY fly yoke

Portable Speakers

NuQ

NuQ82-AN

600 Watt 2 Way 8" Full Range
Powered Loudspeaker with
KLARK TEKNIK DSP Technology and
ULTRANET Networking

Technical Specifications

System

Frequency Response	65 Hz – 18 kHz \pm 3 dB 55 Hz – 20 kHz -10 dB
Nominal Dispersion	100° H x 60° V @ -6 dB points, rotatable
Maximum SPL	122 dB peak
Crossover Type	Active
Transducers	1 x 8" (211.5 mm) LF driver 1 x 1" (25.4 mm) HF compression driver
Limiter	Independent HF, LF, peak and rms

Amplifier

Maximum Output Power*	600 W
Type	Class-D
Protection	Short circuit, thermal

Connectors

Input/link	1 x combo jack/XLR, 1 x XLR
Sensitivity	+4dBu or +14 dBu software switchable
Input impedance	40 k Ω balanced
Maximum input level	+22 dBu
Ultranet input/link	2 x RJ45
Mains Supply	Neutrik powerCON 20A†

Controls

DSP	Rotary push-encoder and level control Buttons for process, setup, exit, enter
-----	--

User DSP Functions

Factory EQ Presets	Positioning, sound mode, FBQ
Display	LCD 128 x 32, blue, backlit
Delay	0 - 300 ms
Equalisation	High and low shelving EQ 2 x parametric EQ
Limiter	Zero attack input limiter
Presets	20 total presets, 19 user-definable
Crossover	High pass L-R 24 dB/oct
Protection	Lock-out function for all settings

Ultranet Digital Network

Digital processing	
A/D conversion	24-bit, 44.1/48 kHz sample rate
Converter type	24-bit, delta-sigma
System	
Signal	16 channels
Latency	< 0.9 ms
Frequency response	20 Hz to 20 kHz (+0 / -3 dB)
Dynamic range	typical 92 dB
Cabling	
Cables	Shielded CAT5
Cable length	max. 246 ft / 75 m recommended

Portable Speakers

NuQ

NuQ82-AN

600 Watt 2 Way 8" Full Range
Powered Loudspeaker with
KLARK TEKNIK DSP Technology and
ULTRANET Networking

Power Supply

Power consumption	80 W @ 1/8 max power
Voltage (fuses)	
USA / Canada	120 V~, 60 Hz (T 6.3 A H 250 V)
UK / Australia / Europe	220-240 V~, 50/60 Hz (T 3.15 A H 250 V)
Korea / China	220-240 V~, 50/60 Hz (T 3.15 A H 250 V)
Japan	100 V~, 50/60 Hz (T 6.3 A H 250 V)

Enclosure

Dimensions HWD	464 x 274 x 252 mm (18.3 x 10.8 x 9.9")
Net weight	11.3 kg (24.9 lbs)
Construction	12 mm (1/2") birch plywood
Finish	Semi matt black paint
Grille	Powder coated perforated steel
Flying hardware	M10 x 8 points; M8 x 1 point

Accessories

NuQ82-SB swivel bracket for NuQ82
NuQ82-EB extension bracket for NuQ82
NuQ82-FY flying yoke for NuQ82

*independent of limiters and driver protection circuits

Neutrik and powerCON speakON are registered trademarks of Neutrik AG.

Only qualified personnel are allowed to modify the AC-Main cord and to adhere to all applicable national standards.

Portable Speakers

NuQ

NuQ82-AN

600 Watt 2 Way 8" Full Range
Powered Loudspeaker with
KLARK TEKNIK DSP Technology and
ULTRANET Networking

Architecture & Engineering Specifications

The loudspeaker shall be of the full range, two-way, powered type, consisting of one 8" (211 mm) LF driver and one 1" (25 mm) HF compression driver. Performance specifications of a typical production unit shall meet or exceed the following: frequency response, measured with swept sine wave input, shall be flat within ± 3 dB from 65 Hz to 18 kHz and within -10 dB from 55 Hz to 20 kHz. Nominal dispersion, at -6 dB points, shall average 100° H x 60° V, rotatable. Maximum amplifier output power shall be 600 Watts peak, independent of limiters and driver protection circuits. Maximum SPL (peak), measured at 1 metre with music program, shall be 122 dB. Dimensions: 464 mm high x 274 mm wide x 252 mm deep (18.3" x 10.3" x 9.9"). Net weight: 11.3 kg (24.9 lbs). The loudspeaker system shall be the [TURBOSOUND NuQ82-AN](#). No other loudspeaker shall be acceptable unless submitted data from an independent test laboratory verifies that the above combined performance / size specifications are equaled or exceeded.



You Are Covered

We always strive to provide the best possible Customer Experience. Our products are made in our own [MUSIC Group](#) factory using state-of-the-art automation, enhanced production workflows and quality assurance labs with the most sophisticated test equipment available in the world.

As a result, we have one of the lowest product failure rates in the industry, and we confidently back it up with a generous [3-Year Warranty program](#).

Portable Speakers

NuQ

NuQ82-AN

600 Watt 2 Way 8" Full Range
Powered Loudspeaker with
KLARK TEKNIK DSP Technology and
ULTRANET Networking



Portable Speakers

NuQ

NuQ82-AN

600 Watt 2 Way 8" Full Range
Powered Loudspeaker with
KLARK TEKNIK DSP Technology and
ULTRANET Networking

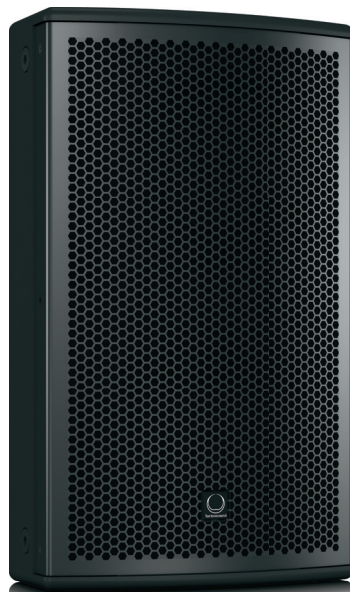

Portable Speakers

NuQ NuQ82-AN

600 Watt 2 Way 8" Full Range
Powered Loudspeaker with
KLARK TEKNIK DSP Technology and
ULTRANET Networking

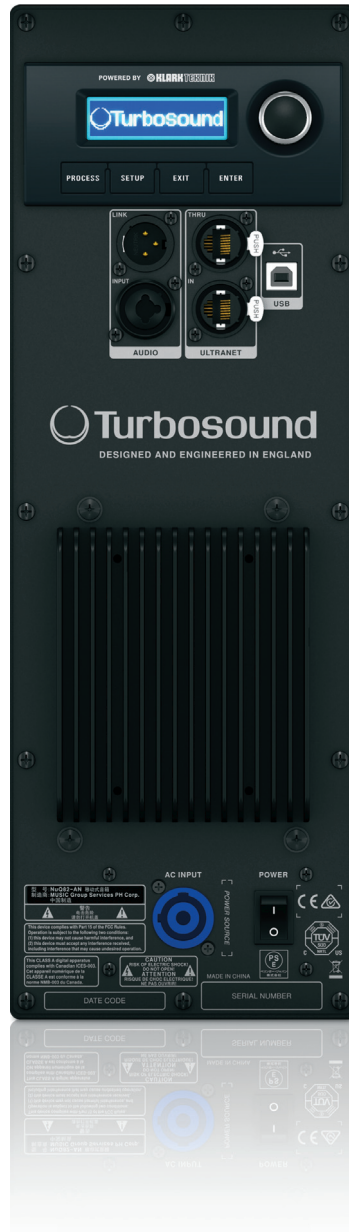

For service, support or more information contact the TURBOSOUND location nearest you:

Europe
MUSIC Group Services UK
Tel: +44 156 273 2290
Email: CARE@music-group.com

USA/Canada
MUSIC Group Services NV Inc.
Tel: +1 702 800 8290
Email: CARE@music-group.com

Japan
MUSIC Group Services JP K.K.
Tel: +81 3 6231 0454
Email: CARE@music-group.com

MUSIC Group accepts no liability for any loss which may be suffered by any person who relies either wholly or in part upon any description, photograph, or statement contained herein. Technical specifications, appearances and other information are subject to change without notice. All trademarks are the property of their respective owners. MIDAS, KLARK TEKNIK, LAB GRUPPEN, LAKE, TANNÖY, TURBOSOUND, TC ELECTRONIC, TC HELICON, BEHRINGER, BUGERA and DDA are trademarks or registered trademarks of MUSIC Group IP Ltd.
© MUSIC Group IP Ltd. 2016 All rights reserved.