

## Portable Speakers

# NuQ122-AN

2500 Watt 2 Way 12" Full Range  
Powered Loudspeaker with  
KLARK TEKNIK DSP Technology and  
ULTRANET Networking

- 2 way full range powered loudspeaker for portable PA and installation applications
- 2,500 Watt power featuring KLARK TEKNIK Class-D technology
- KLARK TEKNIK Digital Signal Processing for total system control
- ULTRANET digital audio networking connects to mixers and other sources
- 12" low frequency driver with low mass voice coil for improved transient response
- Aluminium dome 1" neodymium motor compression driver
- Low distortion waveguide provides 70° H x 70° V dispersion
- Fully featured user interface with LCD display for ease of navigation
- PC remote control software downloadable at [turbosound.com](http://turbosound.com)
- 15 mm (5/8") birch plywood enclosure with hard wearing semi matt black paint finish
- Rugged powder coated perforated steel mesh grille
- Integral 35 mm pole mount and handles
- Multiple internal rigging points allow bracket mount and suspension in any orientation
- Mains input on Neutrik powerCON\* connector
- 3-Year Warranty Program\*
- Designed and engineered in England



The 2 way full range NuQ122-AN is a 2,500 Watt 12" powered loudspeaker system that is ideally suited for a wide range of portable and fixed installation speech and music sound reinforcement applications. Designed to work individually without a controller, the NuQ122-AN provides optimal performance for FOH, sidefill and delay line loudspeakers, and is an exceptional choice for wedge monitoring applications. It also offers the flexibility to accommodate venue-specific requirements for install applications.



The NuQ122 loudspeaker features a 12" low frequency driver with a low mass voice coil for improved transient response and an aluminium dome 1" neodymium high frequency compression driver, which is mounted on a 70° horizontal by 70° vertical dispersion low distortion waveguide.

Output power for the NuQ122-AN is provided by means of an efficient and lightweight KLARK TEKNIK 2,500-Watt Class-D power amplifier. A sophisticated, but easy to use KLARK TEKNIK Digital Signal Processor (DSP) provides dynamic EQ for impressive full range response at low volume levels and transparent limiting for clarity at high output levels – and for long-term reliability.

# NuQ122-AN

2500 Watt 2 Way 12" Full Range  
Powered Loudspeaker with  
KLARK TEKNIK DSP Technology and  
ULTRANET Networking

On the rear panel of the amplifier module, the user interface's LCD display and single rotary encoder provide intuitive access to: position compensation, user EQ control, subwoofer integration and signal routing features. In addition to the balanced XLR input, an XLR output is provided for daisy-chaining more active loudspeakers or for use with active subwoofers. An onboard USB port provides access for remote control of the NuQ122-AN via PC computer, as well as DSP firmware updates.

ULTRANET connectivity is provided by two locking etherCON\* connectors. Up to 16 independent channels of 24-bit digital audio and control data are transmitted via a single CAT5 cable between compatible digital devices – including mixers, I/O stage boxes, powered loudspeakers and personal monitoring systems. Simplified cable routing and ease of setup translate directly into significant time saved during installation.

Finished in a highly durable semi matt black paint, the trapezoidal cabinet is constructed from 15 mm (5/8") birch plywood – and includes a rugged powder coated perforated steel mesh grille. Multiple threaded rigging points are provided for suspension in any orientation. The [NuQ122-FY](#) flying yoke kit provides added flexibility in permanent install applications (available separately). The NuQ122-AN also features a 35 mm socket for standard pole mounting – plus integrated handles for convenient transport. Mains power input is provided via a Neutrik powerCON\* connector.



## You Are Covered

We always strive to provide the best possible Customer Experience. Our products are made in our own [MUSIC Group](#) factory using state-of-the-art automation, enhanced production workflows and quality assurance labs with the most sophisticated test equipment available in the world. As a result, we have one of the lowest product failure rates in the industry, and we confidently back it up with a generous [3-Year Warranty program](#).

Portable Speakers

# NuQ122-AN

2500 Watt 2 Way 12" Full Range  
Powered Loudspeaker with  
KLARK TEKNIK DSP Technology and  
ULTRANET Networking

## Frequency Response Sensitivity 1 W / 1 m

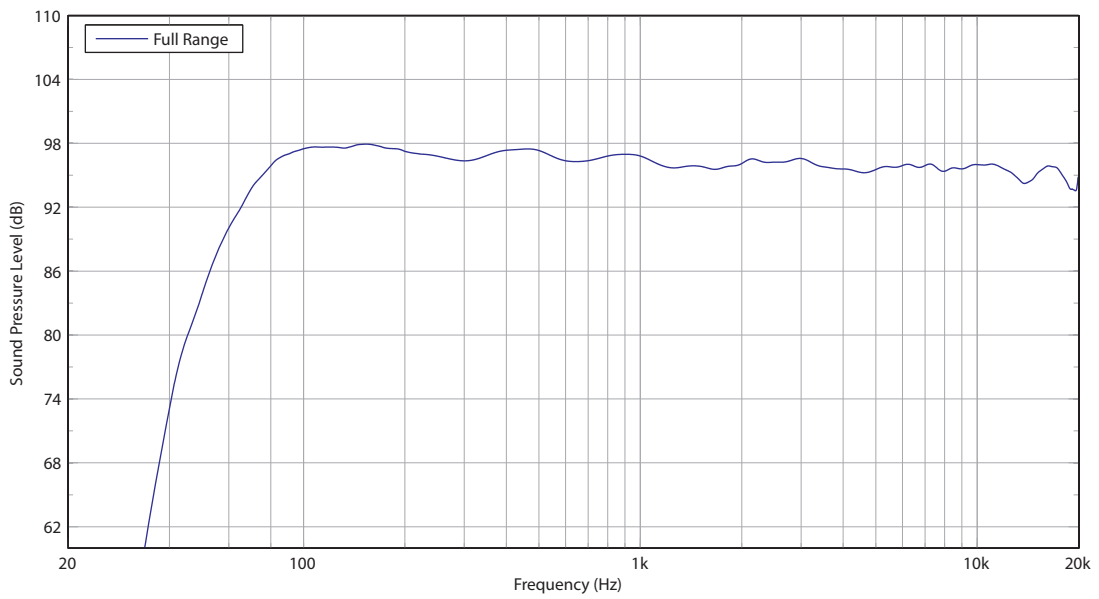

Portable Speakers

# NuQ122-AN

2500 Watt 2 Way 12" Full Range  
Powered Loudspeaker with  
KLARK TEKNIK DSP Technology and  
ULTRANET Networking

## Horizontal Beamwidth

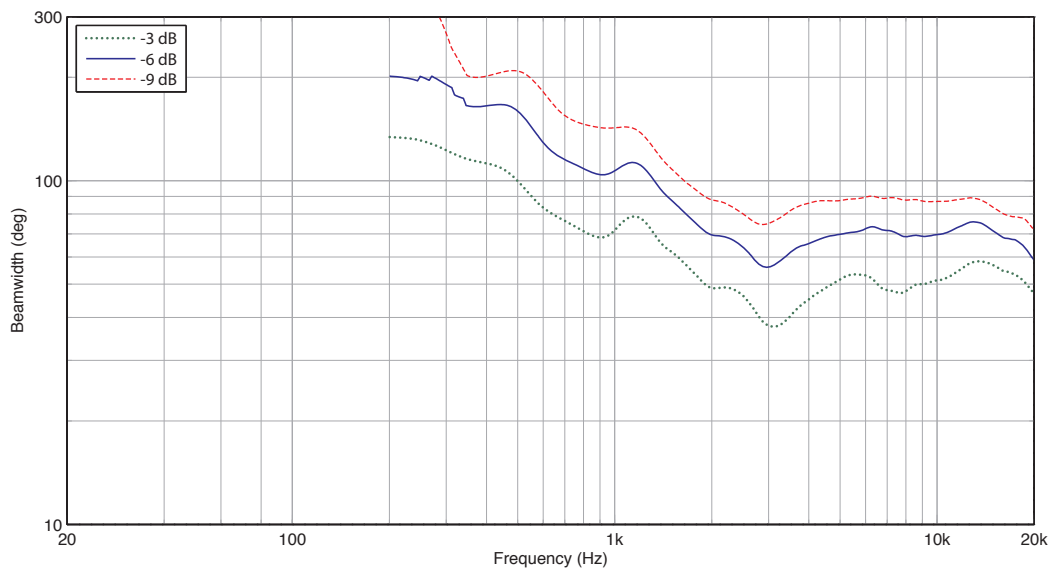

## Vertical Beamwidth

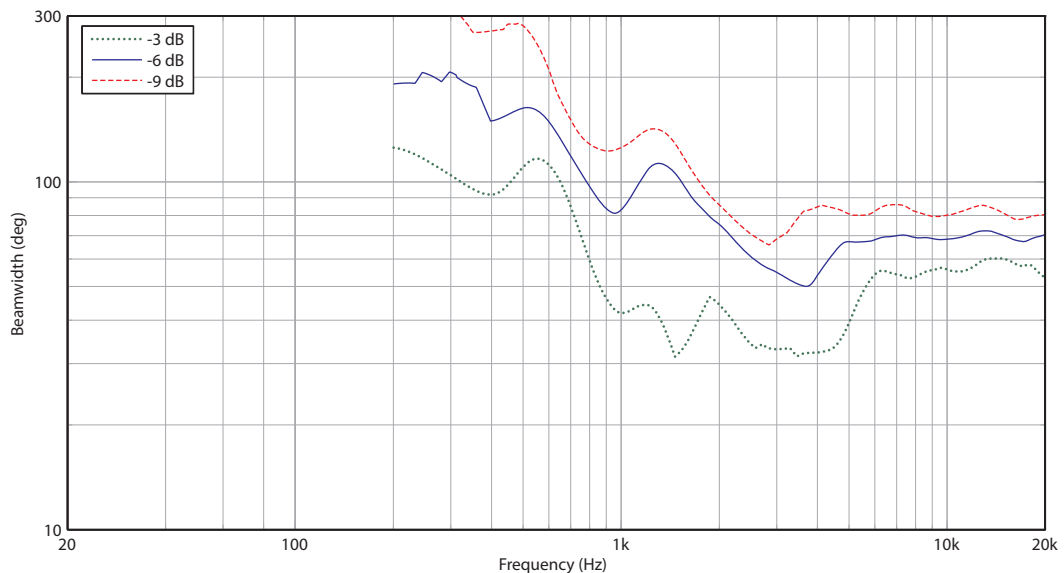

Portable Speakers

# NuQ122-AN

2500 Watt 2 Way 12" Full Range  
Powered Loudspeaker with  
KLARK TEKNIK DSP Technology and  
ULTRANET Networking

## Horizontal Polar Plots

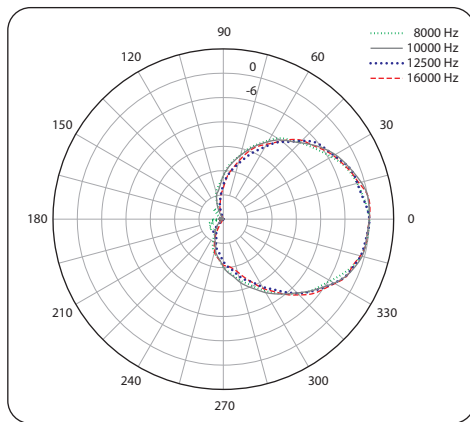
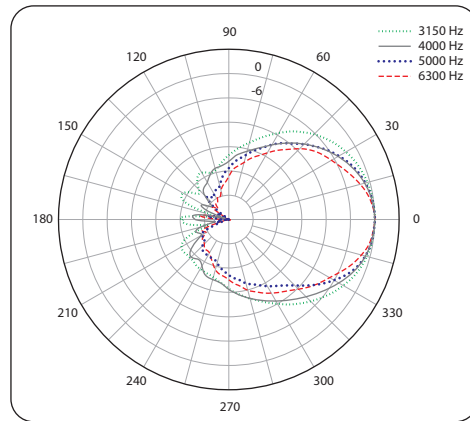
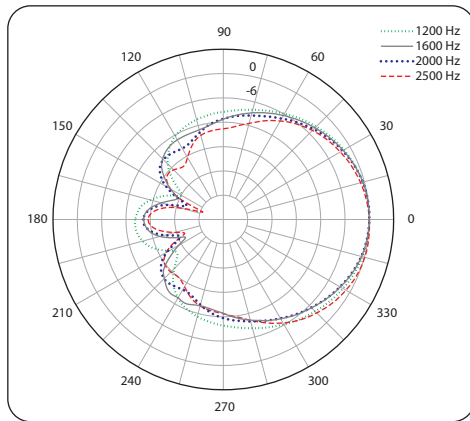
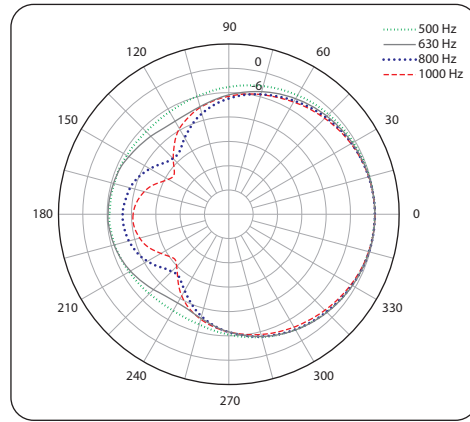
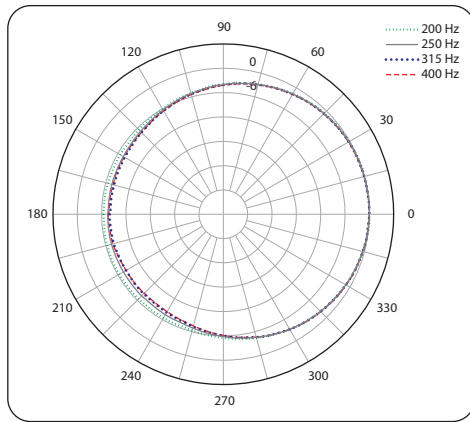

Portable Speakers

# NuQ122-AN

2500 Watt 2 Way 12" Full Range  
Powered Loudspeaker with  
KLARK TEKNIK DSP Technology and  
ULTRANET Networking

## Vertical Polar Plots

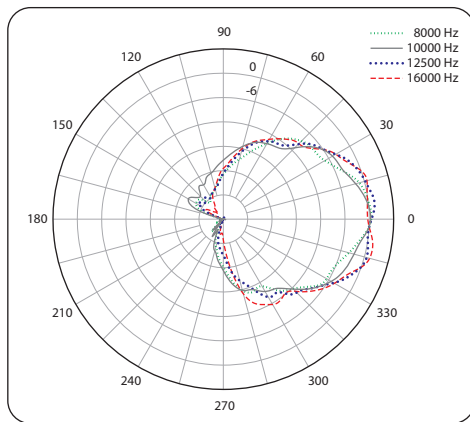
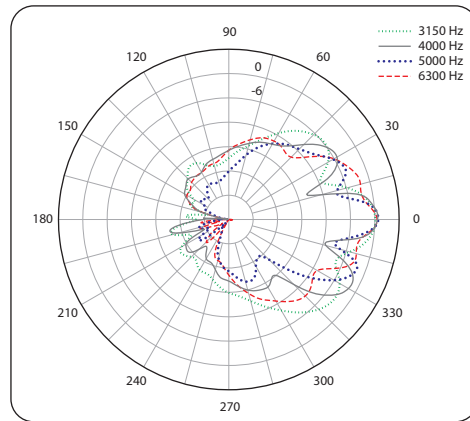
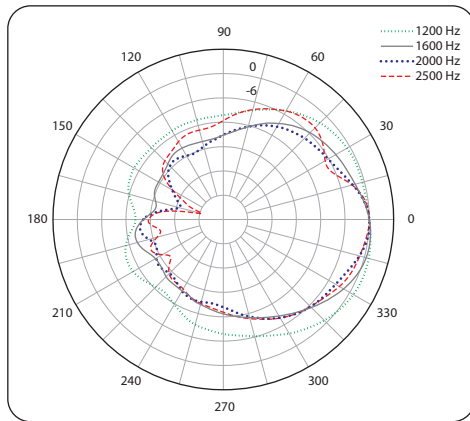
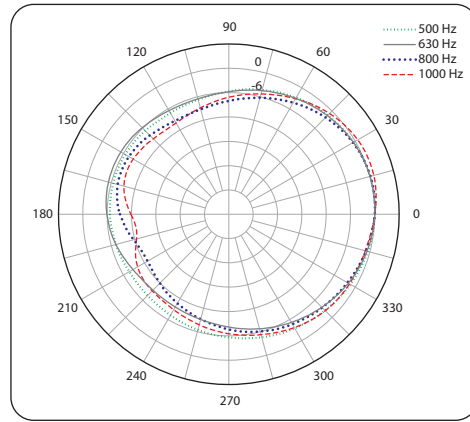
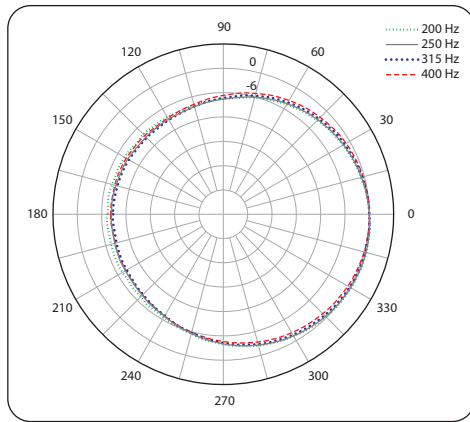

## Portable Speakers

# NuQ122-AN

2500 Watt 2 Way 12" Full Range  
Powered Loudspeaker with  
KLARK TEKNIK DSP Technology and  
ULTRANET Networking

## Dimensions

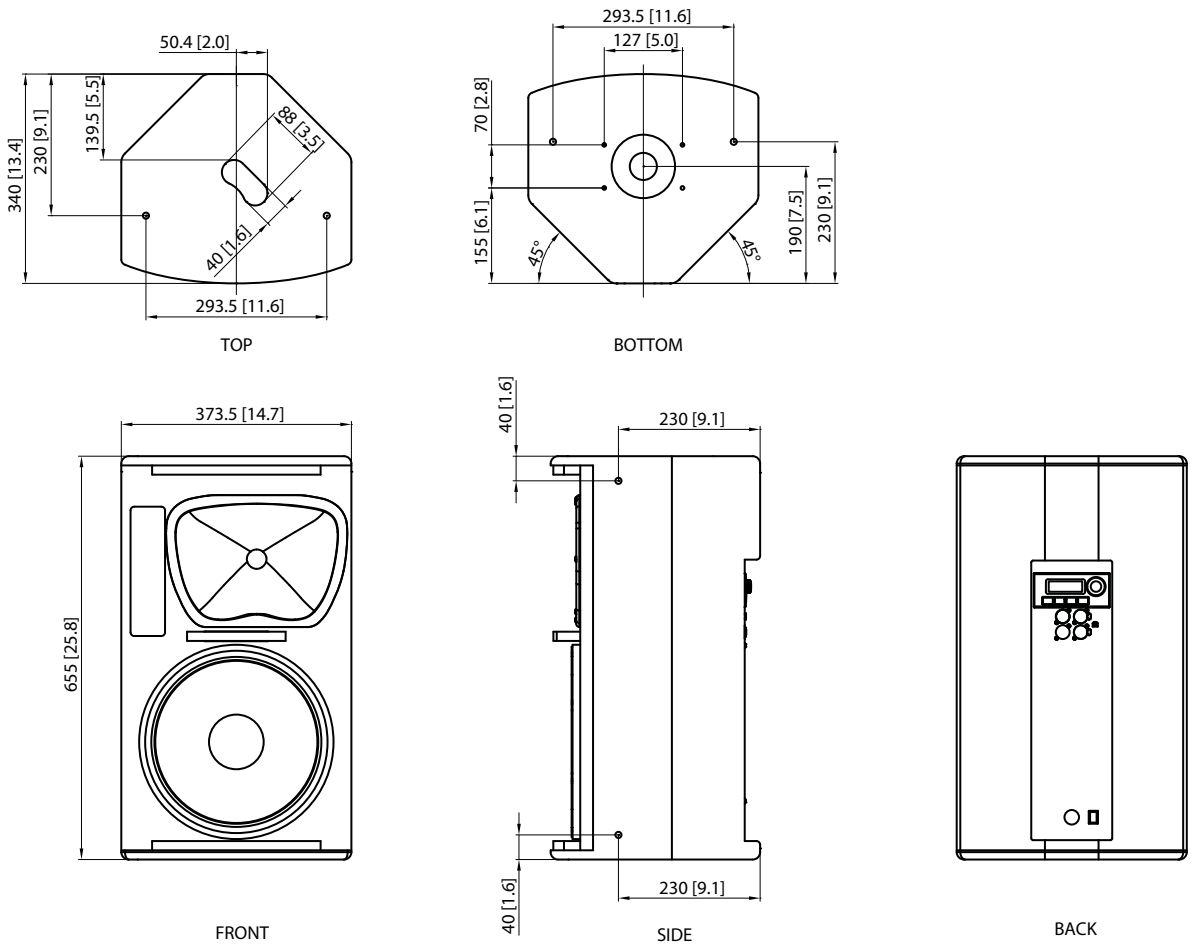

## Portable Speakers

# NuQ122-AN

2500 Watt 2 Way 12" Full Range  
Powered Loudspeaker with  
KLARK TEKNIK DSP Technology and  
ULTRANET Networking

## Mounting and Rigging

The cabinet is fitted with M10 x 8 internally-threaded rigging points that allow it to be rigged with optional shoulder eyebolts and mounted in many different configurations in permanent installations. The simplest method of rigging is to use the two M10 rigging points on the top. Cabinets may also be hung upside down if required.

The cabinet has an integral 35 mm pole mount socket in the bottom panel, that allows it to be pole mounted.

The optional [NuQ122-FY](#) fly yoke adds further installation flexibility for scaffold, surface, and pole mounting.

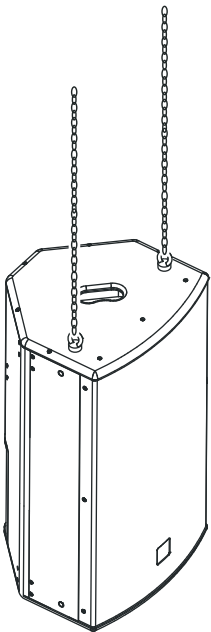

Suspension using M10  
shoulder eyebolts.

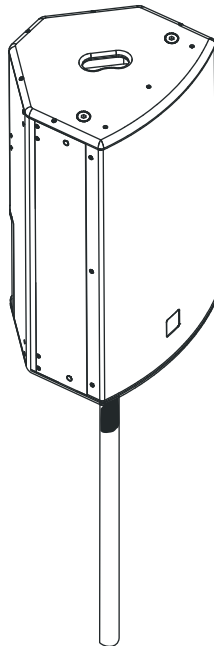

Mounting on 35 mm  
pole or speaker stand

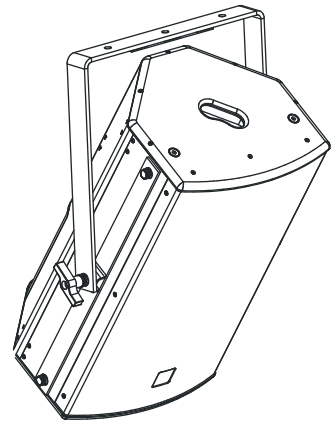

NuQ122-FY fly yoke.



## Portable Speakers

# NuQ122-AN

2500 Watt 2 Way 12" Full Range  
Powered Loudspeaker with  
KLARK TEKNIK DSP Technology and  
ULTRANET Networking

## Technical Specifications

### System

Frequency Response	55 Hz – 18 kHz $\pm$ 3 dB 50 Hz – 20 kHz -10 dB
Nominal Dispersion	70° H x 70° V @ -6 dB points
Maximum SPL	131 dB peak
Crossover Type	Active
Transducers	1 x 12" (315.5) LF driver 1 x 1" (25.4 mm) HF compression driver
Limiter	Independent HF, LF, peak and rms

### Amplifier

Maximum Output Power*	2,500 W
Type	Class-D
Protection	Short circuit, thermal

### Connectors

Input/link	1 x Combo Jack/XLR 1 x XLR
Sensitivity	+4dBu or +14 dBu software switchable
Input impedance	40 k $\Omega$ balanced
Maximum input level	+22 dBu
Ultranet input/link	2 x RJ45
Mains Supply	Neutrik powerCON 20A†

### Controls

DSP	Rotary push-encoder and level control Buttons for Process, Setup, Exit, Enter
-----	--

### User DSP Functions

Factory EQ Presets	Positioning, Sound mode, FBQ
Display	LCD 128 x 32, blue, backlit
Delay	0 - 300 ms
Equalisation	High and low shelving EQ 2 x parametric EQ
Limiter	Zero attack input limiter
Presets	20 total presets, 19 user-definable
Crossover	High Pass L-R 24 dB/oct
Protection	Lock-out function for all settings

### Ultranet Digital Network

<b>Digital processing</b>	
A/D conversion	24-bit, 44.1/48kHz sample rate
Converter type	24-bit, delta-sigma
<b>System</b>	
Signal	16 channels
Latency	< 0.9 ms
Frequency response	20 Hz to 20 kHz (+0 / -3 dB)
Dynamic range	typical 92 dB
<b>Cabling</b>	
Cables	Shielded CAT5
Cable length	max. 246 ft / 75 m recommended

## Portable Speakers

# NuQ122-AN

2500 Watt 2 Way 12" Full Range  
Powered Loudspeaker with  
KLARK TEKNIK DSP Technology and  
ULTRANET Networking

### Power Supply

<b>Power consumption</b>	90 W @ 1/8 max power
<b>Voltage (fuses)</b>	
USA / Canada	120 V~, 60 Hz (T 15 A H 250 V)
UK / Australia / Europe	220-240 V~, 50/60 Hz (T 10 A H 250 V)
Korea / China	220-240 V~, 50/60 Hz (T 10 A H 250 V)
Japan	100 V~, 50/60 Hz (T15 A H 250 V)

### Enclosure

<b>Dimensions (H x W x D)</b>	655 x 373.5 x 340 mm (25.8 x 14.7 x 13.4")
<b>Net weight</b>	20.2 kg (44.5 lbs)
<b>Construction</b>	15 mm (5/8") birch plywood
<b>Finish</b>	Semi matt black paint
<b>Grille</b>	Powder coated perforated steel
<b>Flying hardware</b>	M10 x 8 points

### Accessories

NuQ122-FY flying yoke for NuQ122

\*independent of limiters and driver protection circuits

†Neutrik and powerCON speakON are registered trademarks of Neutrik AG.

‡Only qualified personnel are allowed to modify the AC-Main cord and to adhere to all applicable national standards.

# NuQ122-AN

2500 Watt 2 Way 12" Full Range  
Powered Loudspeaker with  
KLARK TEKNIK DSP Technology and  
ULTRANET Networking

## Architecture & Engineering Specifications

The loudspeaker shall be of the full range, two-way, powered type, consisting of one 12" (316 mm) LF driver and one 1" (25 mm) HF compression driver. Performance specifications of a typical production unit shall meet or exceed the following: frequency response, measured with swept sine wave input, shall be flat within  $\pm 3$  dB from 55 Hz to 18 kHz and within -10 dB from 50 Hz to 20 kHz. Nominal dispersion, at -6 dB points, shall average 70° H x 70° V. Maximum amplifier output power shall be 2,500 Watts peak, independent of limiters and driver protection circuits. Maximum SPL (peak), measured at 1 metre with music program, shall be 131 dB. Dimensions: 655 mm high x 373.5 mm wide x 340 mm deep (25.8" x 14.7" x 13.4"). Net weight: 20.2 kg (44.5 lbs). The loudspeaker system shall be the [TURBOSOUND NuQ122-AN](#). No other loudspeaker shall be acceptable unless submitted data from an independent test laboratory verifies that the above combined performance / size specifications are equaled or exceeded.

Portable Speakers

# NuQ122-AN

2500 Watt 2 Way 12" Full Range  
Powered Loudspeaker with  
KLARK TEKNIK DSP Technology and  
ULTRANET Networking



Portable Speakers

# NuQ122-AN

2500 Watt 2 Way 12" Full Range  
Powered Loudspeaker with  
KLARK TEKNIK DSP Technology and  
ULTRANET Networking

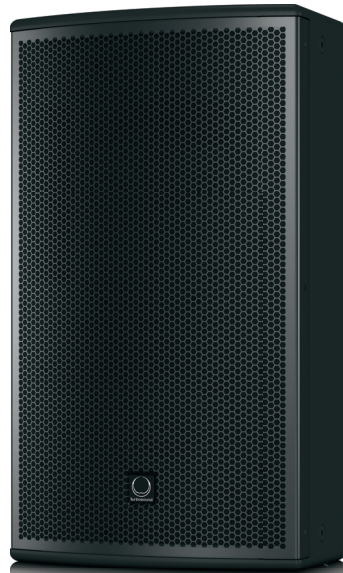

Portable Speakers

# NuQ122-AN

2500 Watt 2 Way 12" Full Range  
Powered Loudspeaker with  
KLARK TEKNIK DSP Technology and  
ULTRANET Networking



For service, support or more information contact the TURBOSOUND location nearest you:

**Europe**  
**MUSIC Group Services UK**  
Tel: +44 156 273 2290  
Email: CARE@music-group.com

**USA/Canada**  
**MUSIC Group Services NV Inc.**  
Tel: +1 702 800 8290  
Email: CARE@music-group.com

**Japan**  
**MUSIC Group Services JP K.K.**  
Tel: +81 3 6231 0454  
Email: CARE@music-group.com

MUSIC Group accepts no liability for any loss which may be suffered by any person who relies either wholly or in part upon any description, photograph, or statement contained herein. Technical specifications, appearances and other information are subject to change without notice. All trademarks are the property of their respective owners. MIDAS, KLARK TEKNIK, LAB GRUPPEN, LAKE, TANNÖY, TURBOSOUND, TC ELECTRONIC, TC HELICON, BEHRINGER, BUGERA and DDA are trademarks or registered trademarks of MUSIC Group IP Ltd.  
© MUSIC Group IP Ltd. 2016 All rights reserved.

