



NuQ-AN SERIES

**NuQ82-AN (WH), NuQ102-AN (WH), NuQ122-AN (WH), NuQ152-AN (WH)
NuQ115B-AN (WH), NuQ118B-AN (WH)**

**600 and 2,500 Watt 2 Way Full Range Powered Loudspeakers
3000 Watt Powered Subwoofers
KLARK TEKNIK DSP Technology and ULTRANET Networking**

Quickstart Guide





EN

EN Important Safety Instructions

 Terminals marked with this symbol carry electrical current of sufficient magnitude to constitute risk of electric shock. Use only high-quality commercially-available speaker cables with plugs pre-installed. All other installation or modification should be performed only by qualified personnel.

 This symbol, wherever it appears, alerts you to the presence of uninsulated dangerous voltage inside the enclosure - voltage that may be sufficient to constitute a risk of shock.

 This symbol, wherever it appears, alerts you to important operating and maintenance instructions in the accompanying literature. Please read the manual.

 **Caution**
To reduce the risk of electric shock, do not remove the top cover (or the rear section). No user serviceable parts inside. Refer servicing to qualified personnel.

 **Caution**
To reduce the risk of fire or electric shock, do not expose this appliance to rain and moisture. The apparatus shall not be exposed to dripping or splashing liquids and no objects filled with liquids, such as vases, shall be placed on the apparatus.

 **Caution**
These service instructions are for use by qualified service personnel only. To reduce the risk of electric shock do not perform any servicing other than that contained in the operation instructions. Repairs have to be performed by qualified service personnel.

1. Read these instructions.
2. Keep these instructions.
3. Heed all warnings.
4. Follow all instructions.
5. Do not use this apparatus near water.
6. Clean only with dry cloth.
7. Do not block any ventilation openings. Install in accordance with the manufacturer's instructions.
8. Do not install near any heat sources such as radiators, heat registers, stoves, or other apparatus (including amplifiers) that produce heat.

9. Do not defeat the safety purpose of the polarized or grounding-type plug. A polarized plug has two blades with one wider than the other. A grounding-type plug has two blades and a third grounding prong. The wide blade or the third prong are provided for your safety. If the provided plug does not fit into your outlet, consult an electrician for replacement of the obsolete outlet.

10. Protect the power cord from being walked on or pinched particularly at plugs, convenience receptacles, and the point where they exit from the apparatus.

11. Use only attachments/accessories specified by the manufacturer.



12. Use only with the cart, stand, tripod, bracket, or table specified by the manufacturer, or sold with the apparatus. When a cart is used, use caution when

moving the cart/apparatus combination to avoid injury from tip-over.

13. Unplug this apparatus during lightning storms or when unused for long periods of time.

14. Refer all servicing to qualified service personnel. Servicing is required when the apparatus has been damaged in any way, such as power supply cord or plug is damaged, liquid has been spilled or objects have fallen into the apparatus, the apparatus has been exposed to rain or moisture, does not operate normally, or has been dropped.

15. The apparatus shall be connected to a MAINS socket outlet with a protective earthing connection.

16. Where the MAINS plug or an appliance coupler is used as the disconnect device, the disconnect device shall remain readily operable.



17. Correct disposal of this product: This symbol indicates that this product must not be disposed of with household waste, according to the WEEE Directive (2012/19/EU) and your national law.

This product should be taken to a collection center licensed for the recycling of waste electrical and electronic equipment (EEE). The mishandling of this type of waste could have a possible negative impact on the environment and human health due to potentially hazardous substances that are generally associated with EEE. At the same time, your cooperation in the correct disposal of this product will contribute to the efficient use of natural resources. For more information about where you can take your waste equipment for recycling, please contact your local city office, or your household waste collection service.

LEGAL DISCLAIMER

MUSIC Group accepts no liability for any loss which may be suffered by any person who relies either wholly or in part upon any description, photograph, or statement contained herein. Technical specifications, appearances and other information are subject to change without notice. All trademarks are the property of their respective owners. MIDAS, KLARK TEKNIK, TURBOSOUND, BEHRINGER, BUGERA and DDA are trademarks or registered trademarks of MUSIC Group IP Ltd. © MUSIC Group IP Ltd. 2015 All rights reserved.

LIMITED WARRANTY

For the applicable warranty terms and conditions and additional information regarding MUSIC Group's Limited Warranty, please see complete details online at music-group.com/warranty.

ES Instrucciones de seguridad

 Las terminales marcadas con este símbolo transportan corriente eléctrica de magnitud suficiente como para constituir un riesgo de descarga eléctrica. Utilice solo cables de altavoz de alta calidad con clavijas TS de 6,3 mm pre-instaladas (puede adquirirlas en comercios especializados en audio). Cualquier otra instalación o modificación debe ser realizada únicamente por un técnico cualificado.

 Este símbolo, siempre que aparece, le advierte de la presencia de voltaje peligroso sin aislar dentro de la caja; este voltaje puede ser suficiente para constituir un riesgo de descarga.

 Este símbolo, siempre que aparece, le advierte sobre instrucciones operativas y de mantenimiento que aparecen en la documentación adjunta. Por favor, lea el manual.

 **Atención**
Para reducir el riesgo de descarga eléctrica, no quite la tapa (o la parte posterior). No hay piezas en el interior del equipo que puedan ser reparadas por el usuario. Si es necesario, póngase en contacto con personal cualificado.

 **Atención**
Para reducir el riesgo de incendio o descarga eléctrica, no exponga este aparato a la lluvia, humedad o alguna otra fuente que pueda salpicar o derramar algún líquido sobre el aparato. No coloque ningún tipo de recipiente para líquidos sobre el aparato.

 **Atención**
Las instrucciones de servicio deben llevarlas a cabo exclusivamente personal cualificado. Para evitar el riesgo de una descarga eléctrica, no realice reparaciones que no se encuentren descritas en el manual de operaciones. Las reparaciones deben ser realizadas exclusivamente por personal cualificado.

1. Lea las instrucciones.
2. Conserve estas instrucciones.
3. Preste atención a todas las advertencias.

4. Siga todas las instrucciones.
5. No use este aparato cerca del agua.
6. Limpie este aparato con un paño seco.
7. No bloquee las aberturas de ventilación. Instale el equipo de acuerdo con las instrucciones del fabricante.

8. No instale este equipo cerca de fuentes de calor tales como radiadores, acumuladores de calor, estufas u otros aparatos (incluyendo amplificadores) que puedan producir calor.

9. No elimine o deshabilite nunca la conexión a tierra del aparato o del cable de alimentación de corriente. Un enchufe polarizado tiene dos polos, uno de los cuales tiene un contacto más ancho que el otro. Una clavija con puesta a tierra dispone de tres contactos: dos polos y la puesta a tierra. El contacto ancho y el tercer contacto, respectivamente, son los que garantizan una mayor seguridad. Si el enchufe suministrado con el equipo no concuerda con la toma de corriente, consulte con un electricista para cambiar la toma de corriente obsoleta.

10. Coloque el cable de suministro de energía de manera que no pueda ser pisado y que esté protegido de objetos afilados. Asegúrese de que el cable de suministro de energía esté protegido, especialmente en la zona de la clavija y en el punto donde sale del aparato.

11. Use únicamente los dispositivos o accesorios especificados por el fabricante.



12. Use únicamente la carretilla, plataforma, trípode, soporte o mesa especificados por el fabricante o suministrados junto con el equipo. Al transportar el

equipo, tenga cuidado para evitar daños y caídas al tropezar con algún obstáculo.

13. Desenchufe el equipo durante tormentas o si no va a utilizarlo durante un periodo largo.

14. Confíe las reparaciones únicamente a servicios técnicos cualificados. La unidad requiere mantenimiento siempre que haya sufrido algún daño, si el cable de suministro de energía o el enchufe presentaran daños, se hubiera derramado un líquido o hubieran caído objetos dentro del equipo, si el aparato hubiera estado expuesto a la humedad o la lluvia, si ha dejado de funcionar de manera normal o si ha sufrido algún golpe o caída.

15. Al conectar la unidad a la toma de corriente eléctrica asegúrese de que la conexión disponga de una unión a tierra.

16. Si el enchufe o conector de red sirve como único medio de desconexión, éste debe ser accesible fácilmente.



17. Cómo debe deshacerse de este aparato: Este símbolo indica que este aparato no debe ser tratado como basura orgánica, según lo indicado en la Directiva WEEE (2012/19/EU) y a las

normativas aplicables en su país. En lugar de ello deberá llevarlo al punto limpio más cercano para el reciclaje de sus elementos eléctricos / electrónicos (EEE). Al hacer esto estará ayudando a prevenir las posibles consecuencias negativas para el medio ambiente y la salud que podrían ser provocadas por una gestión inadecuada de este tipo de aparatos. Además, el reciclaje de materiales ayudará a conservar los recursos naturales. Para más información acerca del reciclaje de este aparato, póngase en contacto con el Ayuntamiento de su ciudad o con el punto limpio local.

NEGACIÓN LEGAL

MUSIC Group no admite ningún tipo de responsabilidad por cualquier daño o pérdida que pudiera sufrir cualquier persona por confiar total o parcialmente en la descripción, fotografías o afirmaciones contenidas en este documento. Las especificaciones técnicas, imágenes y otras informaciones contenidas en este documento están sujetas a modificaciones sin previo aviso. Todas las marcas comerciales que aparecen aquí son propiedad de sus respectivos dueños. MIDAS, KLARK TEKNIK, TURBOSOUND, BEHRINGER, BUGERA y DDA son marcas comerciales o marcas registradas de MUSIC Group IP Ltd. © MUSIC Group IP Ltd. 2015 Reservados todos los derechos.

GARANTÍA LIMITADA

Si quiere conocer los detalles y condiciones aplicables de la garantía así como información adicional sobre la Garantía limitada de MUSIC group, consulte online toda la información en la web music-group.com/warranty.

EN

ES

FR Consignes de sécurité

Les points repérés par ce symbole portent une tension électrique suffisante pour constituer un risque d'électrocution. Utilisez uniquement des câbles d'enceintes de haute qualité disponibles dans les points de vente avec les connecteurs Jack mono 6,35 mm déjà installés. Toute autre installation ou modification doit être effectuée uniquement par un personnel qualifié.



Ce symbole avertit de la présence d'une tension dangereuse et non isolée à l'intérieur de l'appareil - elle peut provoquer des chocs électriques.



Attention
Ce symbole signale les consignes d'utilisation et d'entre ! Tien importantes dans la documentation fournie. Lisez les consignes de sécurité du manuel d'utilisation de l'appareil.



Attention
Pour éviter tout risque de choc électrique, ne pas ouvrir le capot de l'appareil ni démonter le panneau arrière. L'intérieur de l'appareil ne possède aucun élément réparable par l'utilisateur. Laissez toute réparation à un professionnel qualifié.



Attention
Pour réduire les risques de feu et de choc électrique, n'exposez pas cet appareil à la pluie, à la moisissure, aux gouttes ou aux éclaboussures. Ne posez pas de récipient contenant un liquide sur l'appareil (un vase par exemple).



Attention
Ces consignes de sécurité et d'entretien sont destinées à un personnel qualifié. Pour éviter tout risque de choc électrique, n'effectuez aucune réparation sur l'appareil qui ne soit décrite par le manuel d'utilisation. Les éventuelles réparations doivent être effectuées uniquement par un technicien spécialisé.

1. Lisez ces consignes.
2. Conservez ces consignes.
3. Respectez tous les avertissements.
4. Respectez toutes les consignes d'utilisation.
5. N'utilisez jamais l'appareil à proximité d'un liquide.

6. Nettoyez l'appareil avec un chiffon sec.

7. Veillez à ne pas empêcher la bonne ventilation de l'appareil via ses ouïes de ventilation. Respectez les consignes du fabricant concernant l'installation de l'appareil.

8. Ne placez pas l'appareil à proximité d'une source de chaleur telle qu'un chauffage, une cuisinière ou tout appareil dégageant de la chaleur (y compris un ampli de puissance).

9. Ne supprimez jamais la sécurité des prises bipolaires ou des prises terre. Les prises bipolaires possèdent deux contacts de largeur différente. Le plus large est le contact de sécurité. Les prises terre possèdent deux contacts plus une mise à la terre servant de sécurité. Si la prise du bloc d'alimentation ou du cordon d'alimentation fourni ne correspond pas à celles de votre installation électrique, faites appel à un électricien pour effectuer le changement de prise.

10. Installez le cordon d'alimentation de telle façon que personne ne puisse marcher dessus et qu'il soit protégé d'arêtes coupantes. Assurez-vous que le cordon d'alimentation est suffisamment protégé, notamment au niveau de sa prise électrique et de l'endroit où il est relié à l'appareil; cela est également valable pour une éventuelle rallonge électrique.

11. Utilisez exclusivement des accessoires et des appareils supplémentaires recommandés par le fabricant.



12. Utilisez exclusivement des chariots, des diables, des présentoirs, des pieds et des surfaces de travail recommandés par le fabricant

ou livrés avec le produit.

Déplacez précautionneusement tout chariot ou diable chargé pour éviter d'éventuelles blessures en cas de chute.

13. Débranchez l'appareil de la tension secteur en cas d'orage ou si l'appareil reste inutilisé pendant une longue période de temps.

14. Les travaux d'entretien de l'appareil doivent être effectués uniquement par du personnel qualifié. Aucun entretien n'est nécessaire sauf si l'appareil est endommagé de quelque façon que ce soit (dommages sur le cordon d'alimentation ou la prise par exemple), si un liquide ou un objet a pénétré à l'intérieur du châssis, si l'appareil a été exposé à la pluie ou à l'humidité, s'il ne fonctionne pas correctement ou à la suite d'une chute.

15. L'appareil doit être connecté à une prise secteur dotée d'une protection par mise à la terre.

16. La prise électrique ou la prise IEC de tout appareil dénué de bouton marche/arrêt doit rester accessible en permanence.



17. Mise au rebut appropriée de ce produit: Ce symbole indique qu'en accord avec la directive DEEE (2012/19/EU) et les lois en vigueur dans votre pays, ce produit ne doit pas être jeté avec les

déchets ménagers. Ce produit doit être déposé dans un point de collecte agréé pour le recyclage des déchets d'équipements électriques et électroniques (EEE). Une mauvaise manipulation de ce type de déchets pourrait avoir un impact négatif sur l'environnement et la santé à cause des substances potentiellement dangereuses généralement associées à ces équipements. En même temps, votre coopération dans la mise au rebut de ce produit contribuera à l'utilisation efficace des ressources naturelles. Pour plus d'informations sur l'endroit où vous pouvez déposer vos déchets d'équipements pour le recyclage, veuillez contacter votre mairie ou votre centre local de collecte des déchets.

DÉNI LÉGAL

MUSIC Group ne peut être tenu pour responsable pour toute perte pouvant être subie par toute personne se fiant en partie ou en totalité à toute description, photographie ou affirmation contenue dans ce document. Les caractéristiques, l'apparence et d'autres informations peuvent faire l'objet de modifications sans notification. Toutes les marques appartiennent à leurs propriétaires respectifs. MIDAS, KLARK TEKNIK, TURBOSOUND, BEHRINGER, BUGERA et DDA sont des marques ou marques déposées de MUSIC Group IP Ltd. © MUSIC Group IP Ltd. 2015 Tous droits réservés.

GARANTIE LIMITÉE

Pour connaître les termes et conditions de garantie applicables, ainsi que les informations supplémentaires et détaillées sur la Garantie Limitée de MUSIC Group, consultez le site Internet music-group.com/warranty.

DE Wichtige Sicherheitshinweise

Vorsicht
Die mit dem Symbol markierten Anschlüsse führen so viel Spannung, dass die Gefahr eines Stromschlags besteht. Verwenden Sie nur hochwertige, im Handel erhältliche Lautsprecherkabel mit vorinstallierten 6,3 mm TS-Steckern. Alle anderen Installationen oder Modifikationen sollten nur von qualifiziertem Fachpersonal ausgeführt werden.



Achtung
Um eine Gefährdung durch Stromschlag auszuschließen, darf die Geräteabdeckung bzw. Geräterückwand nicht abgenommen werden. Im Innern des Geräts befinden sich keine vom Benutzer reparierbaren Teile. Reparaturarbeiten dürfen nur von qualifiziertem Personal ausgeführt werden.



Achtung
Um eine Gefährdung durch Feuer bzw. Stromschlag auszuschließen, darf dieses Gerät weder Regen oder Feuchtigkeit ausgesetzt werden noch sollten Spritzwasser oder tropfende Flüssigkeiten in das Gerät gelangen können. Stellen Sie keine mit Flüssigkeit gefüllten Gegenstände, wie z. B. Vasen, auf das Gerät.



Achtung
Die Service-Hinweise sind nur durch qualifiziertes Personal zu befolgen. Um eine Gefährdung durch Stromschlag zu vermeiden, führen Sie bitte keinerlei Reparaturen an dem Gerät durch, die nicht in der Bedienungsanleitung detailliert sind. Reparaturen sind nur von qualifiziertem Fachpersonal durchzuführen.

1. Lesen Sie diese Hinweise.
2. Bewahren Sie diese Hinweise auf.
3. Beachten Sie alle Warnhinweise.
4. Befolgen Sie alle Bedienungshinweise.
5. Betreiben Sie das Gerät nicht in der Nähe von Wasser.
6. Reinigen Sie das Gerät mit einem trockenen Tuch.
7. Blockieren Sie nicht die Belüftungsschlitze. Beachten Sie beim Einbau des Gerätes die Herstellerhinweise.
8. Stellen Sie das Gerät nicht in der Nähe von Wärmequellen auf. Solche Wärmequellen sind z. B. Heizkörper, Herde oder andere Wärme erzeugende Geräte (auch Verstärker).

9. Entfernen Sie in keinem Fall die Sicherheitsvorrichtung von Zweipol- oder geerdeten Steckern. Ein Zweipolstecker hat zwei unterschiedlich breite Steckkontakte. Ein geerdeter Stecker hat zwei Steckkontakte und einen dritten Erdungskontakt. Der breitere Steckkontakt oder der zusätzliche Erdungskontakt dient Ihrer Sicherheit. Falls das mitgelieferte Steckerformat nicht zu Ihrer Steckdose passt, wenden Sie sich bitte an einen Elektriker, damit die Steckdose entsprechend ausgetauscht wird.

10. Verlegen Sie das Netzkabel so, dass es vor Tritten und scharfen Kanten geschützt ist und nicht beschädigt werden kann. Achten Sie bitte insbesondere im Bereich der Stecker, Verlängerungskabel und an der Stelle, an der das Netzkabel das Gerät verlässt, auf ausreichenden Schutz.

11. Das Gerät muss jederzeit mit intaktem Schutzleiter an das Stromnetz angeschlossen sein.

12. Sollte der Hauptnetzstecker oder eine Gerätesteckdose die Funktionseinheit zum Abschalten sein, muss diese immer zugänglich sein.

13. Verwenden Sie nur Zusatzgeräte/ Zubehörteile, die laut Hersteller geeignet sind.



14. Verwenden Sie nur Wagen, Standvorrichtungen, Stative, Halter oder Tische, die vom Hersteller benannt oder im Lieferumfang des Geräts enthalten

sind. Falls Sie einen Wagen benutzen, seien Sie vorsichtig beim Bewegen der Wagen-Gerätkombination, um Verletzungen durch Stolpern zu vermeiden.

15. Ziehen Sie den Netzstecker bei Gewitter oder wenn Sie das Gerät längere Zeit nicht benutzen.

16. Lassen Sie alle Wartungsarbeiten nur von qualifiziertem Service-Personal ausführen. Eine Wartung ist notwendig, wenn das Gerät in irgendeiner Weise beschädigt wurde (z. B. Beschädigung des Netzkabels oder Steckers), Gegenstände oder Flüssigkeit in das Geräteinnere gelangt sind, das Gerät Regen oder Feuchtigkeit ausgesetzt wurde, das Gerät nicht ordnungsgemäß funktioniert oder auf den Boden gefallen ist.



17. Korrekte Entsorgung dieses Produkts: Dieses Symbol weist darauf hin, das Produkt entsprechend der WEEE Richtlinie (2012/19/EU) und der jeweiligen nationalen Gesetze nicht zusammen mit Ihren Haushaltsabfällen zu entsorgen. Dieses Produkt sollte bei einer autorisierten Sammelstelle für Recycling elektrischer und elektronischer Geräte (EEE) abgegeben werden. Wegen bedenklicher Substanzen,

die generell mit elektrischen und elektronischen Geräten in Verbindung stehen, könnte eine unsachgemäße Behandlung dieser Abfallart eine negative Auswirkung auf Umwelt und Gesundheit haben. Gleichzeitig gewährleistet Ihr Beitrag zur richtigen Entsorgung dieses Produkts die effektive Nutzung natürlicher Ressourcen. Für weitere Informationen zur Entsorgung Ihrer Geräte bei einer Recycling-Stelle nehmen Sie bitte Kontakt zum zuständigen städtischen Büro, Entsorgungsamt oder zu Ihrem Haushaltsabfallentsorger auf.

HAFTUNGSAUSSCHLUSS

MUSIC Group übernimmt keine Haftung für Verluste, die Personen entstanden sind, die sich ganz oder teilweise auf hier enthaltene Beschreibungen, Fotos oder Aussagen verlassen haben. Technische Daten, Erscheinungsbild und andere Informationen können ohne vorherige Ankündigung geändert werden. Alle Warenzeichen sind Eigentum der jeweiligen Inhaber. MIDAS, KLARK TEKNIK, TURBOSOUND, BEHRINGER, BUGERA und DDA sind Warenzeichen oder eingetragene Warenzeichen der MUSIC Group IP Ltd. © MUSIC Group IP Ltd. 2015 Alle Rechte vorbehalten.

BESCHRÄNKTE GARANTIE

Die geltenden Garantiebedingungen und zusätzliche Informationen bezüglich der von MUSIC Group gewährten beschränkten Garantie finden Sie online unter music-group.com/warranty.

PT Instruções de Segurança Importantes



Aviso!

Terminais marcados com o símbolo carregam corrente elétrica de magnitude suficiente para constituir um risco de choque elétrico. Use apenas cabos de alto-falantes comercialmente disponíveis de alta qualidade com plugues TS de ¼" pré-instalados. Todas as outras instalações e modificações devem ser efetuadas por pessoas qualificadas.



Este símbolo, onde quer que o encontre, alerta-o para a leitura das instruções de manuseamento que acompanham o equipamento. Por favor leia o manual de instruções.



Atenção

De forma a diminuir o risco de choque elétrico, não remover a cobertura (ou a secção de trás). Não existem peças substituíveis por parte do utilizador no seu interior. Para esse efeito recorrer a um técnico qualificado.



Atenção

Para reduzir o risco de incêndios ou choques elétricos o aparelho não deve ser exposto à chuva nem à humidade. Além disso, não deve ser sujeito a salpicos, nem devem ser colocados em cima do aparelho objectos contendo líquidos, tais como jarras.



Atenção

Estas instruções de operação devem ser utilizadas, em exclusivo, por técnicos de assistência qualificados. Para evitar choques elétricos não proceda a reparações ou intervenções, que não as indicadas nas instruções de operação, salvo se possuir as qualificações necessárias. Para evitar choques elétricos não proceda a reparações ou intervenções, que não as indicadas nas instruções de operação. Só o deverá fazer se possuir as qualificações necessárias.

1. Leia estas instruções.
2. Guarde estas instruções.
3. Preste atenção a todos os avisos.
4. Siga todas as instruções.
5. Não utilize este dispositivo perto de água.
6. Limpe apenas com um pano seco.
7. Não obstrua as entradas de ventilação. Instale de acordo com as instruções do fabricante.

8. Não instale perto de quaisquer fontes de calor tais como radiadores, bocas de ar quente, fogões de sala ou outros aparelhos (incluindo amplificadores) que produzam calor.

9. Não anule o objectivo de segurança das fichas polarizadas ou do tipo de ligação à terra. Uma ficha polarizada dispõe de duas palhetas sendo uma mais larga do que a outra. Uma ficha do tipo ligação à terra dispõe de duas palhetas e um terceiro dente de ligação à terra. A palheta larga ou o terceiro dente são fornecidos para sua segurança. Se a ficha fornecida não encaixar na sua tomada, consulte um electricista para a substituição da tomada obsoleta.

10. Proteja o cabo de alimentação de pisadelas ou apertos, especialmente nas fichas, extensões, e no local de saída da unidade. Certifique-se de que o cabo eléctrico está protegido. Verifique particularmente nas fichas, nos receptáculos e no ponto em que o cabo sai do aparelho.

11. O aparelho tem de estar sempre conectado à rede eléctrica com o condutor de protecção intacto.

12. Se utilizar uma ficha de rede principal ou uma tomada de aparelhos para desligar a unidade de funcionamento, esta deve estar sempre acessível.

13. Utilize apenas ligações/acessórios especificados pelo fabricante.



14. Utilize apenas com o carrinho, estrutura, tripé, suporte, ou mesa especificados pelo fabricante ou vendidos com o dispositivo. Quando utilizar

um carrinho, tenha cuidado ao mover o conjunto carrinho/dispositivo para evitar danos provocados pela terpidação.

15. Desligue este dispositivo durante as trovoadas ou quando não for utilizado durante longos períodos de tempo.

16. Qualquer tipo de reparação deve ser sempre efectuado por pessoal qualificado. É necessária uma reparação sempre que a unidade tiver sido de alguma forma danificada, como por exemplo: no caso do cabo de alimentação ou ficha se encontrarem danificados; na eventualidade de líquido ter sido derramado ou objectos terem caído para dentro do dispositivo; no caso da unidade ter estado exposta à chuva ou à humidade; se esta não funcionar normalmente, ou se tiver caído.



17. Correcta eliminação deste produto: este símbolo indica que o produto não deve ser eliminado juntamente com os resíduos domésticos, segundo a Directiva REEE

(2012/19/EU) e a legislação nacional. Este produto deverá ser levado para um centro de recolha licenciado para a reciclagem de resíduos de equipamentos eléctricos e electrónicos (EEE). O tratamento incorrecto deste tipo de resíduos pode ter um eventual impacto negativo no ambiente e na saúde humana devido a substâncias potencialmente perigosas que estão geralmente associadas aos EEE. Ao mesmo tempo, a sua colaboração para a eliminação correcta deste produto irá contribuir para a utilização eficiente dos recursos naturais. Para mais informação acerca dos locais onde poderá deixar o seu equipamento usado para reciclagem, é favor contactar os serviços municipais locais, a entidade de gestão de resíduos ou os serviços de recolha de resíduos domésticos.

LEGAL RENUNCIANTE

O MUSIC Group não se responsabiliza por perda alguma que possa ser sofrida por qualquer pessoa que dependa, seja de maneira completa ou parcial, de qualquer descrição, fotografia, ou declaração aqui contidas. Dados técnicos, aparências e outras informações estão sujeitas a modificações sem aviso prévio. Todas as marcas são propriedade de seus respectivos donos. MIDAS, KLARK TEKNIK, TURBOSOUND, BEHRINGER, BUGERA e DDA são marcas ou marcas registradas do MUSIC Group IP Ltd. © MUSIC Group IP Ltd. 2015 Todos direitos reservados.

GARANTIA LIMITADA

Para obter os termos de garantia aplicáveis e condições e informações adicionais a respeito da garantia limitada do MUSIC group, favor verificar detalhes na íntegra através do website music-group.com/warranty.

JP 安全にお使いいただくために



注意

感電の恐れがありますので、カバーやその他の部品を取り外したり、開けたりしないでください。高品質なプロ用スピーカーケーブル (¼" TS 標準ケーブルおよびツイスト ロッキングプラグケーブル) を使用してください。



注意

火事および感電の危険を防ぐため、本装置を水分や湿気のあるところには設置しないで下さい。装置には決して水分がかからないように注意し、花瓶など水分を含んだものは、装置の上には置かないようにしてください。



注意

このマークが表示されている箇所には、内部に高圧電流が生じています。手を触れると感電の恐れがあります。



注意

取り扱いとお手入れの方法についての重要な説明が付属の取扱説明書に記載されています。ご使用前に良くお読みください。



注意

1. 取扱説明書を通してご覧ください。
2. 取扱説明書を大切に保管してください。
3. 警告に従ってください。
4. 指示に従ってください。
5. 本機を水の近くで使用しないでください。
6. お手入れの際は常に乾燥した布巾を使ってください。
7. 本機は、取扱説明書の指示に従い、適切な換気を妨げない場所に設置してください。取扱説明書に従って設置してください。
8. 本機は、電気ヒーターや温風機器、ストーブ、調理台やアンプといった熱源から離して設置してください。

9. 二極式プラグおよびアースタイプ (三芯) プラグの安全ピンは取り外さないでください。二極式プラグにはピンが二本ついでおり、そのうち一本はもう一方よりも幅が広がっています。アースタイプの三芯プラグには二本のピンに加えてアース用のピンが一本ついています。これらの幅の広いピン、およびアースピンは、安全のためのものです。備え付けのプラグが、お使いのコンセントの形状と異なる場合は、電器技師に相談してコンセントの交換をして下さい。

10. 電源コードを踏みつけたり、挟んだりしないようご注意ください。電源コードやプラグ、コンセント及び製品との接続には十分にご注意ください。

11. すべての装置の接地 (アース) が確保されていることを確認して下さい。



12. 電源タップや電源プラグは電源遮断機として利用されている場合には、これが直ぐに操作できるように手元に設置して下さい。

13. 付属品は本機製造元が指定したもののみをお使いください。

14. カートスタンド、三脚、ブラケット、テーブルなどは、本機製造元が指定したものの、もしくは本機の付属品となるもののみをお使いください。カートを使用時の運搬の際は、器具の落下による怪我に十分ご注意ください。

15. 雷雨の場合、もしくは長期間ご使用にならない場合は、電源プラグをコンセントから抜いてください。

16. 故障の際は当社指定のサービス技術者にお問い合わせください。電源コードもしくはプラグの損傷、液体の装置内への浸入、装置の上に物が落下した場合、雨や湿気に装置が晒されてしまった場合、正常に作動しない場合、もしくは装置を地面に落下させてしまった場合など、いかなる形であれ装置に損傷が加わった場合は、装置の修理・点検を受けてください。



17. 本製品に電源コードが付属されている場合、付属の電源コードは本製品以外ではご使用いたしません。電源コードは必ず本製品に付属された電源コードのみご使用ください。

法的放棄

ここに含まれる記述、写真、意見の全体または一部に依拠して、いかなる人が損害を生じさせた場合にも、MUSIC Groupは一切の賠償責任を負いません。技術仕様、外観およびその他の情報は予告なく変更になる場合があります。商標はすべて、それぞれの所有者に帰属します。MIDAS、KLARK TEKNIK、TURBOSOUND、BEHRINGER、BUGERA および DDA は MUSIC Group IP Ltd. の商標または登録商標です。© MUSIC Group IP Ltd. 2015 無断転用禁止。

限定保証

適用される保証条件と MUSIC Group の限定保証に関する概要については、オンライン上 music-group.com/warranty にて詳細をご確認ください。

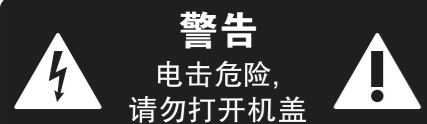
CN 重要的安全须知

带有此标志的终端设备具有强大的电流, 存在触电危险。仅限使用带有 ¼" TS 或扭锁式插头的高品质专业扬声器线。所有的安装或调整均须由合格的专业人员进行。



此标志提醒您, 产品内存在未绝缘的危险电压, 有触电危险。



此标志提醒您查阅所附的重要的使用及维修说明。请阅读有关手册。



小心
为避免触电危险, 请勿打开机顶盖 (或背面挡板)。设备内没有可供用户维修使用的部件。请将维修事项交由合格的专业人员进行。



小心
为避免着火或触电危险, 请勿将此设备置于雨淋或潮湿中。此设备也不可受液体滴溅, 盛有液体的容器也不可置于其上, 如花瓶等。



小心
维修说明仅是给合格的专业维修人员使用的。为避免触电危险, 除了使用说明书提到的以外, 请勿进行任何其它维修。所有维修均须由合格的专业人员进行。

1. 请阅读这些说明。
2. 请妥善保存这些说明。
3. 请注意所有的警示。
4. 请遵守所有的说明。
5. 请勿在靠近水的地方使用本产品。
6. 请用干布清洁本产品。
7. 请勿堵塞通风口。安装本产品时请遵照厂家的说明。
8. 请勿将本产品安装在热源附近, 如暖气片, 炉子或其它产生热量的设备 (包括功放器)。
9. 请勿移除极性插头或接地插头的安全装置。接地插头是由两个插塞接点及一个接地头构成。若随货提供的插头不适合您的插座, 请找电工更换一个合适的插座。
10. 妥善保护电源线, 使其不被践踏或刺破, 尤其注意电源插头、多用途插座及设备连接处。

11. 请只使用厂家指定的附属设备和配件。



备倾倒是受伤。

13. 遇闪电雷鸣或长期不使用本设备时, 请拔出电源插头。

14. 所有维修均须由合格的维修人员进行。设备受损时需进行维修, 例如电源线或电源插头受损, 液体流入或异物落入设备内, 设备遭雨淋或受潮, 设备不能正常运作或被摔坏。

15. 本设备连接电源时一定要要有接地保护。



16. 若电源插头或器具耦合器用作断电装置, 应当保证它们处于随时可方便操作状态。

17. 本产品仅适用于海拔 2000 米以下地区, 本产品仅适用于非热带气候条件下。

**法律声明**

对于任何因在此说明书提到的全部或部份描述、图片或声明而造成的损失, MUSIC Group 不负任何责任。技术参数和外观若有更改, 恕不另行通知。所有的商标均为其各自所有者的财产。MIDAS, KLARK TEKNIK, TURBOSOUND, BEHRINGER, BUGERA 和 DDA 是 MUSIC Group IP Ltd. 公司的商标或注册商标。© MUSIC Group IP Ltd. 2015 版权所有。

保修条款

有关音乐集团保修的适用条款及其它相关信息, 请登陆 music-group.com/warranty 网站查看完整的详细信息。

Thank you for choosing a TURBOSOUND loudspeaker product for your application. If you would like further information about this or any other TURBOSOUND product, please visit our website at turbosound.com.

EN**Unpacking the Loudspeaker**

After unpacking the unit please check carefully for damage. If damage is found, please notify your supplier at once. You, the consignee, must instigate any claim. Please retain all packaging in case of future re-shipment.

Controls

- EN**
- 1 **LCD SCREEN** displays the current DSP module and parameter settings.
 - 2 **SETUP** button steps through parameters within DSP processing modules.
 - 3 **PROCESS** button steps through the DSP processing modules.
 - 4 **AUDIO LINK** XLR connector provides an un-processed copy of the AUDIO INPUT signal.
 - 5 **AUDIO INPUT** combo jack accepts input signals using XLR, balanced ¼" TRS or unbalanced ¼" TS connectors.
 - 6 **POWER** switch turns the unit on and off.
 - 7 **AC INPUT** accepts power connections from power cables fitted with Neutrik powerCON twist-locking connectors.
 - 8 **ENCODER KNOB** toggles between Graphic and Edit modes (when pressed) and changes parameter values (when rotated).
 - 9 **EXIT** button returns to the top-level DSP screen when pressed.
 - 10 **ENTER** button saves changes and deactivates Edit mode when pressed.
 - 11 **ULTRANET THRU** sends out unprocessed digital audio from the ULTRANET IN connector to additional ULTRANET-equipped devices.
 - 12 **USB** connection enables firmware updates and remote control over parameters via computer. Please visit turbosound.com to download DSP control software for your computer.
 - 13 **ULTRANET IN** RJ45/Neutrik etherCON jack for connection to additional ULTRANET-equipped devices.

Networking capability





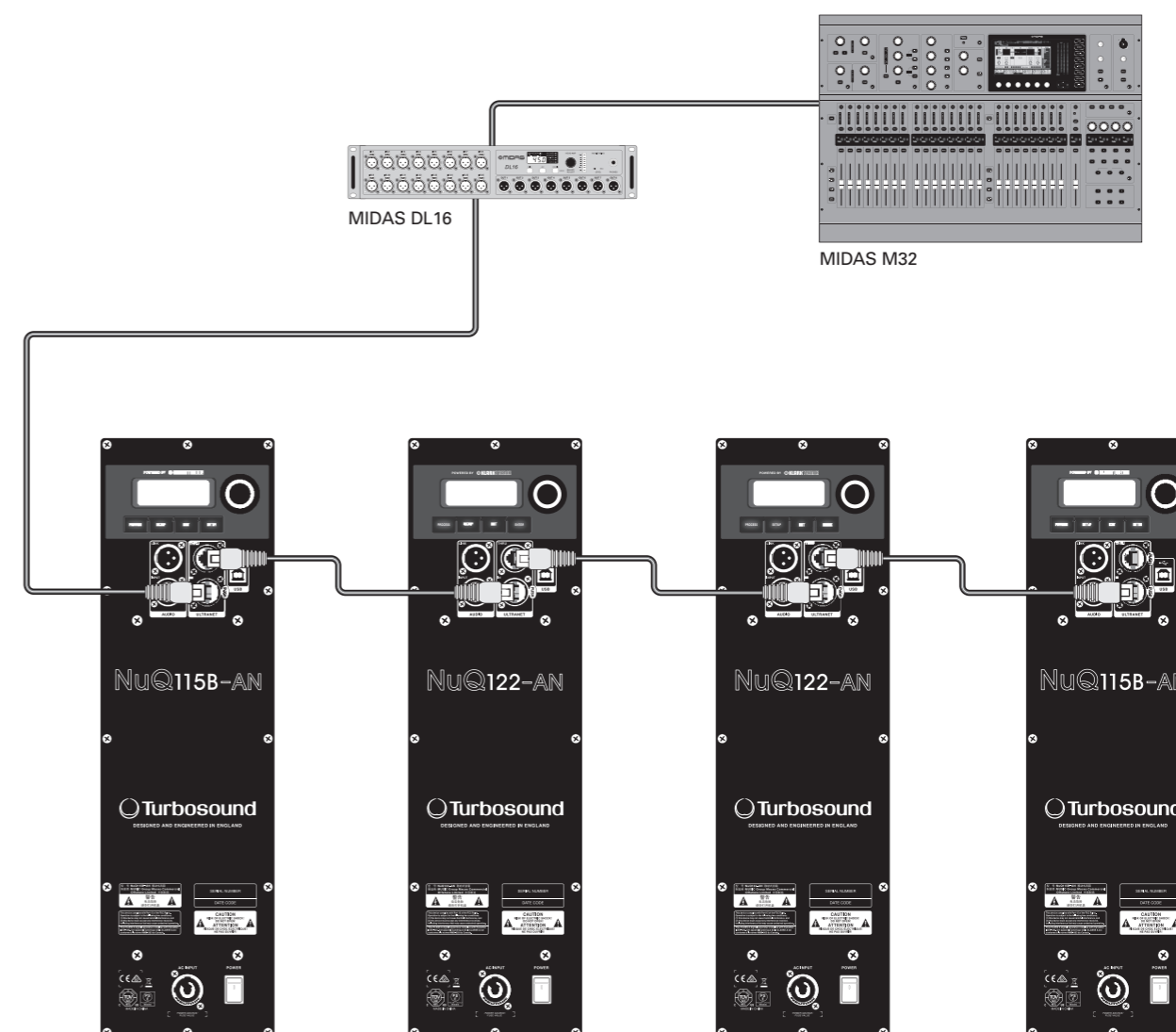

All NuQ-AN powered loudspeakers offer remote control via USB. The USB connection allows the user to configure and monitor all DSP parameters using dedicated software for PC.







The DSP firmware can also be updated via the USB connection. Visit turbosound.com for the latest firmware version.





NuQ-AN speakers also offer proprietary ULTRANET networking capabilities through the ULTRANET IN and ULTRANET THRU connections using CAT5 cables with RJ45 connectors. ULTRANET allows the user to transmit unidirectionally up to 16 independent channels of 24-bit audio throughout the NuQ-AN system, as well as other ULTRANET-equipped devices such as digital mixers and personal monitor systems. Up to 7 devices can be connected in series on a single ULTRANET cable.

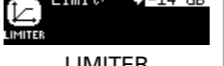

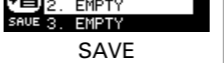
EN NuQ-AN DSP Menu Structure

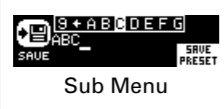
		Fullrange	Subwoofer	Function
		None	None	Sets the frequency response to the default setting.
		Live	Live	Sets the frequency response to a typical live sound setting.
		Speech	Speech	Sets the frequency response for optimal speech intelligibility.
		Playback	Playback	Sets the frequency response ideal for music playback.
		User	User	Lets you define your own frequency response setting by entering the corresponding sub menu.
		Low/ High Shelving	Low/ High Shelving	Lets you define a low and high shelving filter.
		Parametric 1 & 2	Parametric 1 & 2	Lets you define a parametric bell-type EQ (Frequency, Qual. and Gain).
		None	-	Unit is set for default full range reproduction.
		HP 120 Hz	LP 120 Hz	Preset with 120 Hz 24 dB / octave filter for crossover between subwoofer and full-range speakers.
		HP 100 Hz	LP 100 Hz	Preset with 100 Hz 24 dB / octave filter for crossover between subwoofer and full-range speakers.
		-	NuQ82	Preset with ideal settings for use in combination with NuQ82 fullrange speaker.
		-	NuQ102	Preset with ideal settings for use in combination with NuQ102 fullrange speaker.
		-	NuQ122	Preset with ideal settings for use in combination with NuQ122 fullrange speaker.
		-	NuQ152	Preset with ideal settings for use in combination with NuQ152 fullrange speaker.
		NuQ115B	-	Preset with high pass alignment for NuQ115B subwoofer.
		NuQ118B	-	Preset with high pass alignment for NuQ118B subwoofer.
		User	User	User crossover sub menu for combination with other fullrange or subwoofer speaker systems
		Freq	Freq	Select the desired crossover frequency: For fullrange systems: 75 Hz to 400 Hz For subwoofer systems: 50 Hz to 150 Hz
		Phase	Phase	Adjust the absolute phase (0° or 180°)
		Auto	Auto	Automatically sets as many filters as required. Whenever a new feedback frequency is discovered, the first filter will be released to attenuate the new frequency, and so forth.
		Single	Single	Activates the FBQ (feedback detection) functionality, up to 8 feedback filters

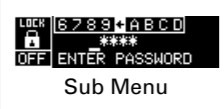
		Fullrange	Subwoofer	Function
		Learn	Learn	Automatic procedure which searches for feedback frequencies and locks settings after all 8 filters have been set. WARNING! Please use ear protection during this procedure. The feedback signal may approach the system's maximum level, which may cause hearing damage!
		Reset	Reset	Resets all filters.
		Input	Input	Lets you choose the audio input source. Choose between Local (analogue Input) or ULTRANET (e.g., P16 monitoring system or M32 audio via ULTRANET).
		Volume	Volume	Adjusts the input gain. With ULTRANET digital inputs over a range from+ 10 dB to - 30 dB. With analogue input from 0 dB to -∞dB.
		Sensitivity	Sensitivity	Adjusts input sensitivity for maximum output when using an analogue source +4 dBu for normal operation, + 14 dBu for high level input.
		Stand	Floor	For positioning the speaker on a pole mount stand (fullrange) or on the floor (Subwoofer)
		Wall	Wall	For positioning the speaker on or next to a wall (fixed install); alternatively as a monitor speaker (wedge).
		Ceiling	-	For positioning the speaker on a wall next to the ceiling (fixed install)
		Corner	Corner	For positioning the speaker in a corner next to the ceiling (fixed install); For positioning the speaker in a corner (subwoofer)
Screenshot update		Delay	Delay	Adjusts the amount of delay (max 300 msec = 103.08 m or 338.19 feet).
		Unit	Unit	Selector between msec, meter and feet.
		Limit	Limit	Adjust the limiter threshold for the input signal (from OFF down to -30 dB). This threshold adjustment allows you to set a max output power which is below the loudspeaker system's rated max output.
		Version	Version	Displays the installed firmware version.
		1 - 20.	1 - 20.	To load a specific preset, turn the encoder to select the desired preset's number, and then either the ENTER button or the encoder. When asked to confirm press the encoder again or EXIT to abort.
		1 - 20.	1 - 20.	To save a preset choose the respective preset slot and press ENTER or the encoder.

	Fullrange	Subwoofer	Function
 Sub Menu	Save Preset	Save Preset	Name the preset by choosing the characters with the encoder and pressing to confirm each character. When finished, press the ENTER button to save the preset.
 SETUP	Contrast	Contrast	Adjust LCD panel contrast, The default contrast value is 15.
	Screen	Screen	ON: LCD screen saver (default) turns on automatically after approx. 2 minutes. OFF : LCD turns off automatically after approx. 5 minutes.
	Logo	Logo	OFF: Deactivates front panel logo illumination. ON: Activates front panel logo illumination. LIMIT: Logo will light up when the limiter is active.
 Sub Menu	Lock	Lock	Lock the device and create a password by choosing the password characters with the encoder and pressing to confirm each character. When finished press the ENTER button. Unlock the device by entering the password or connecting the unit via USB to a PC running propriety remote software. The software does not require a password.
	Warning	Warning	In case of overheating, an alert appears on the LCD screen, and the amplifier will shut down until the unit cools.

LCD Graphic Indicators

To help the user immediately recognize that a parameter has been selected and changed from the initial default setting, the parameter's related text on the top-level screen will invert and change to black text on a white background. As an example, the following screenshots show how the text for the EQ function changes when the NuQ-AN default EQ setting has been changed:

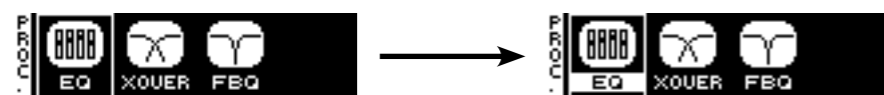

This indicator function occurs only on the main DSP menu level and works for all DSP-related functions, except for the LOAD, SAVE and SETUP sub-sections on the second page of the top-level SETUP menu.

Mounting and Fixing

NuQ-AN full-range series cabinets are designed with multiple internal rigging points to suit many possible mounting methods in permanent installations. NuQ-AN series two-way cabinets are equipped with pole mount sockets for portable use on 35 mm speaker stands or poles. Bass cabinets are equipped with pole mount receptacles that allow two-way cabinets to be mounted at the correct height.

TURBOSOUND wall and ceiling brackets are optionally available for installing NuQ-AN series cabinets. Some examples are shown below.

Model	Flying Yoke	Swivel Bracket	Swivel Extenders	Eyebolts
NuQ82-AN	NuQ82-FY	NuQ82-SB	NuQ82-EB	M10
NuQ102-AN	NuQ102-FY	NuQ102-SB	NuQ102-EB	M10
NuQ122-AN	NuQ122-FY	-	-	M10
NuQ152-AN	NuQ152-FY	-	-	M10

NuQ82-SB

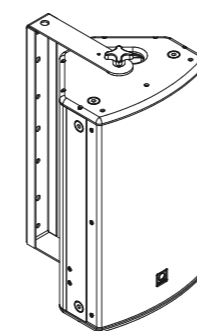

NuQ82-SB + NuQ82-EB

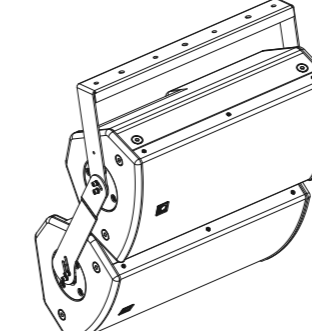

NuQ82-FY

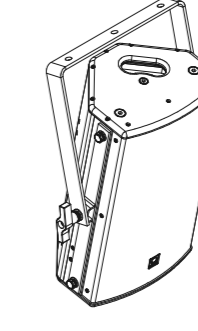

NuQ102-SB

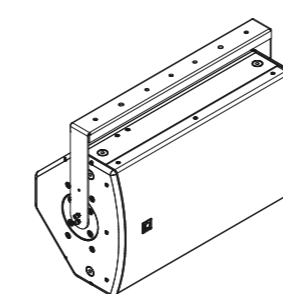

NuQ102-SB + NuQ102-EB

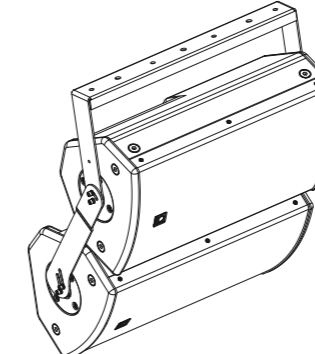

NuQ102-FY

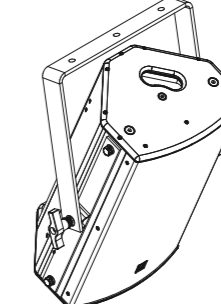

NuQ122-FY

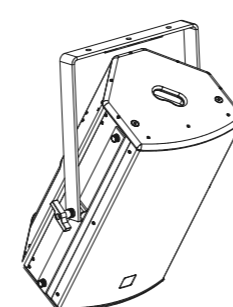

NuQ152-FY

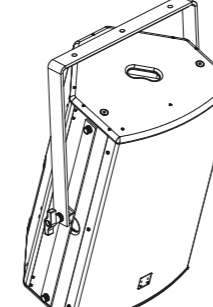

EN

Suspending with Eyebolts

NuQ-AN cabinets can be suspended using optional eyebolts coupled to the internal rigging points provided on the top, bottom and sides and back. The simplest method is to use the two rigging points on the top and a single pull-back rigging point in the centre of the rear panel.

Remove the appropriate countersunk screws and replace them with shoulder eyebolts, which must have a thread length of at least 18 mm. Use the rear rigging point to angle the cabinet for optimum room coverage. Cabinets may be hung upside down if required.

IMPORTANT NOTE FOR ALL INSTALLATION METHODS: The mounting of a permanently installed sound system may be dangerous unless undertaken by qualified personnel with the required experience and certification to perform the necessary tasks. Walls, floors or ceilings must be capable of safely and securely supporting the actual load. The mounting accessory used must be safely and securely fixed both to the loudspeaker and to the wall, floor or ceiling.

When mounting rigging components on walls, floors or ceilings, ensure that all fixings and fasteners used are of an appropriate size and load rating. Wall and ceiling claddings, and the construction and composition of walls and ceilings, all need to be taken into account when determining whether a particular fixing arrangement can be safely employed for a particular load. Cavity plugs or other specialist fixings, if required, must be of an appropriate type, and must be fitted and used in accordance with the maker's instructions.

The operation of your speaker cabinet as part of a flown system, if installed incorrectly and improperly, can potentially expose persons to serious health risks and even death. In addition, please ensure that electrical, mechanical and acoustic considerations are discussed with qualified and certified (by local state or national authorities) personnel prior to any installation or flying.

Make sure that speaker cabinets are set up and flown by qualified and certified personnel only, using dedicated equipment and original parts and components delivered with the unit. If any parts or components are missing please contact your Dealer before attempting to set up the system.

Be sure to observe the local, state and other safety regulations applicable in your country. MUSIC Group, including the MUSIC Group companies listed on the enclosed "Service Information Sheet", assumes no liability for any damage or personal injury resulting from improper use, installation or operation of the product. Regular checks must be conducted by qualified personnel to ensure that the system remains in a secure and stable condition. Make sure that, where the speaker is flown, the area underneath the speaker is free of human traffic. Do not fly the speaker in areas that can be entered or used by members of the public.

Speakers create a magnetic field, even if not in operation. Therefore, please keep all materials that can be affected by such fields (discs, computers, monitors, etc) at a safe distance. A safe distance is usually between 1 and 2 metres.

EN

Technical Specifications

	NuQ82-AN (WH)	NuQ102-AN (WH)	NuQ122-AN (WH)
System			
Frequency response	65 Hz – 18 kHz ±3 dB 55 Hz – 20 kHz -10 dB	55 Hz – 18 kHz ±3 dB 50 Hz – 20 kHz -10 dB	55 Hz – 18 kHz ±3 dB 50 Hz – 20 kHz -10 dB
Nominal dispersion	100° H x 60° V @ -6 dB points, rotatable	100° H x 60° V @ -6 dB points, rotatable	70° H x 70° V @ -6 dB points
Maximum SPL	122 dB peak	122 dB peak	131 dB peak
Crossover type	Active	Active	Active
Transducers	1 x 8" (211.5 mm) LF driver 1 x 1" (25.4 mm) HF compression driver	1 x 10" (261.5 mm) LF driver 1 x 1" (25.4 mm) HF compression driver	1 x 12" (315.5) LF driver 1 x 1" (25.4 mm) HF compression driver
Limiters	Independent HF, LF, peak and rms	Independent HF, LF, peak and rms	Independent HF, LF, peak and rms
Amplifier			
Maximum Output Power*	600 W	600 W	2500 W
Type	Class-D	Class-D	Class-D
Protection	Short circuit, thermal	Short circuit, thermal	Short circuit, thermal
Connectors			
Input/link	1 x combo jack/XLR, 1 x XLR	1 x combo jack/XLR, 1 x XLR	1 x combo jack/XLR, 1 x XLR
Sensitivity	+4dBu or +14 dBu software switchable	+4dBu or +14 dBu software switchable	+4dBu or +14 dBu software switchable
Input impedance	40 kΩ balanced	40 kΩ balanced	40 kΩ balanced
Maximum input level	+22 dBu	+22 dBu	+22 dBu
Ultranet input/link	2 x RJ45	2 x RJ45	2 x RJ45
Mains Supply	Neutrik powerCON 20A	Neutrik powerCON 20A	Neutrik powerCON 20A
Controls			
DSP	Rotary push-encoder and level control Buttons for process, setup, exit, enter	Rotary push-encoder and level control Buttons for process, setup, exit, enter	Rotary push-encoder and level control Buttons for process, setup, exit, enter
User DSP Functions			
Factory EQ Presets	Positioning, sound mode, FBQ	Positioning, sound mode, FBQ	Positioning, sound mode, FBQ
Display	LCD 128 x 32, blue, backlit	LCD 128 x 32, blue, backlit	LCD 128 x 32, blue, backlit
Delay	0 - 300 ms	0 - 300 ms	0 - 300 ms
Equalisation	High and low shelving EQ 2 x parametric EQ	High and low shelving EQ 2 x parametric EQ	High and low shelving EQ 2 x parametric EQ
Limiters	Zero attack input limiter	Zero attack input limiter	Zero attack input limiter
Presets	20 total presets, 19 user-definable	20 total presets, 19 user-definable	20 total presets, 19 user-definable
Crossover	High pass L-R 24 dB/oct	High pass L-R 24 dB/oct	High pass L-R 24 dB/oct
Protection	Lock-out function for all settings	Lock-out function for all settings	Lock-out function for all settings
Ultranet Digital Network			
Digital processing			
A/D conversion	24-bit, 44.1/48kHz sample rate	24-bit, 44.1/48kHz sample rate	24-bit, 44.1/48kHz sample rate
Converter type	24-bit, delta-sigma	24-bit, delta-sigma	24-bit, delta-sigma
System			
Signal	16 channels	16 channels	16 channels
Latency	< 0.9 ms	< 0.9 ms	< 0.9 ms
Frequency response	20 Hz to 20 kHz (+0 / -3 dB)	20 Hz to 20 kHz (+0 / -3 dB)	20 Hz to 20 kHz (+0 / -3 dB)
Dynamic range	Typical 92 dB	Typical 92 dB	Typical 92 dB
Cabling			
Cables	Shielded CAT5	Shielded CAT5	Shielded CAT5
Cable length	Max. 246 ft / 75 m recommended	Max. 246 ft / 75 m recommended	Max. 246 ft / 75 m recommended

	NuQ82-AN (WH)	NuQ102-AN (WH)	NuQ122-AN (WH)
Power Supply			
Power consumption	80 W @ 1/8 max power	80 W @ 1/8 max power	90 W @ 1/8 max power
Voltage (fuses)			
USA / Canada	120 V~, 60 Hz (T 6.3 A H 250 V)	120 V~, 60 Hz (T 6.3 A H 250 V)	120 V~, 60 Hz (T 15 A H 250 V)
UK / Australia / Europe	220-240 V~, 50/60 Hz (T 3.15 A H 250 V)	220-240 V~, 50/60 Hz (T 3.15 A H 250 V)	220-240 V~, 50/60 Hz (T 10 A H 250 V)
Korea / China	220-240 V~, 50/60 Hz (T 3.15 A H 250 V)	220-240 V~, 50/60 Hz (T 3.15 A H 250 V)	220-240 V~, 50/60 Hz (T 10 A H 250 V)
Japan	100 V~, 50/60 Hz (T 6.3 A H 250 V)	100 V~, 50/60 Hz (T 6.3 A H 250 V)	100 V~, 50/60 Hz (T 15 A H 250 V)
Enclosure			
Dimensions HWD	464 x 274 x 252 mm (18.3 x 10.8 x 9.9")	525 x 318 x 281 mm (20.7 x 12.5 x 11.1")	656 x 374 x 340 mm (25.8 x 14.7 x 13.4")
Net weight	11.3 kg (24.9 lbs)	13.7 kg (30.2 lbs)	20.2 kg (44.5 lbs)
Construction	12 mm (1/2") birch plywood	12 mm (1/2") birch plywood	15 mm (5/8") birch plywood
Finish	Semi matt black paint	Semi matt black paint	Semi matt black paint
Grille	Powder coated perforated steel	Powder coated perforated steel	Powder coated perforated steel
Flying hardware	M10 x 8 points; M8 x 1 point	M10 x 8 points; M8 x 1 point	M10 x 8 points
Accessories	NuQ82-SB swivel bracket for NuQ82 NuQ82-EB extension bracket for NuQ82 NuQ82-FY flying yoke for NuQ82	NuQ102-SB swivel bracket for NuQ102 NuQ102-EB extension bracket for NuQ102 NuQ102-FY flying yoke for NuQ102	NuQ122-FY flying yoke for NuQ122

EN Technical Specifications

	NuQ152-AN (WH)	NuQ115B-AN (WH)	NuQ118B-AN (WH)
System			
Frequency response	55 Hz – 18 kHz ±3 dB 50 Hz – 20 kHz -10 dB	45 Hz – 150 Hz ±3 dB 38 Hz – 200 Hz -10 dB	40 Hz – 150 Hz ±3 dB 33 Hz – 150 Hz -10 dB
Nominal dispersion	70° H x 70° V @ -6 dB points	Half Space	Half Space
Maximum SPL	133 dB peak	135 dB peak	136 dB peak
Crossover type	Active	Active	Active
Transducers	1 x 15" (393.5 mm) LF driver 1 x 1" (25.4 mm) HF compression driver	1 x 15" (387 mm) LF driver	1 x 18" (460 mm) LF driver
Limiters	Independent HF, LF, peak and rms	Peak and rms	Peak and rms
Amplifier			
Maximum Output Power*	2500 W	3000 W	3000 W
Type	Class-D	Class-D	Class-D
Protection	Short circuit, thermal	Short circuit, thermal	Short circuit, thermal
Connectors			
Input/link	1 x combo jack/XLR, 1 x XLR	1 x combo jack/XLR, 1 x XLR	1 x combo jack/XLR, 1 x XLR
Sensitivity	+4dBu or +14 dBu software switchable	+4dBu or +14 dBu software switchable	+4dBu or +14 dBu software switchable
Input impedance	40 kΩ balanced	40 kΩ balanced	40 kΩ balanced
Maximum input level	+22 dBu	+22 dBu	+22 dBu
Ultranet input/link	2 x RJ45	2 x RJ45	2 x RJ45
Mains Supply	Neutrik powerCON 20A	Neutrik powerCON 20A	Neutrik powerCON 20A
Controls			
DSP	Rotary push-encoder and level control Buttons for process, setup, exit, enter	Rotary push-encoder and level control Buttons for process, setup, exit, enter	Rotary push-encoder and level control Buttons for process, setup, exit, enter
User DSP Functions			
Factory EQ Presets	Positioning, sound mode, FBQ	Positioning, sound mode	Positioning, sound mode
Display	LCD 128 x 32, blue, backlit	LCD 128 x 32, blue, backlit	LCD 128 x 32, blue, backlit
Delay	0 - 300 ms	0 - 300 ms	0 - 300 ms
Equalisation	High and low shelving EQ 2 x parametric EQ	High and low shelving EQ 2 x parametric EQ	High and low shelving EQ 2 x parametric EQ
Limiters	Zero attack input limiter	Zero attack input limiter	Zero attack input limiter
Presets	20 total presets, 19 user-definable	20 total presets, 19 user-definable	20 total presets, 19 user-definable
Crossover	High pass L-R 24 dB/oct	Low pass L-R 24 dB/oct	Low pass L-R 24 dB/oct
Protection	Lock-out function for all settings	Lock-out function for all settings	Lock-out function for all settings
Ultranet Digital Network			
Digital processing			
A/D conversion	24-bit, 44.1/48kHz sample rate	24-bit, 44.1/48kHz sample rate	24-bit, 44.1/48kHz sample rate
Converter type	24-bit, delta-sigma	24-bit, delta-sigma	24-bit, delta-sigma
System			
Signal	16 channels	16 channels	16 channels
Latency	< 0.9 ms	< 0.9 ms	< 0.9 ms
Frequency response	20 Hz to 20 kHz (+0 / -3 dB)	20 Hz to 20 kHz (+0 / -3 dB)	20 Hz to 20 kHz (+0 / -3 dB)
Dynamic range	Typical 92 dB	Typical 92 dB	Typical 92 dB
Cabling			
Cables	Shielded CAT5	Shielded CAT5	Shielded CAT5
Cable length	Max. 246 ft / 75 m recommended	Max. 246 ft / 75 m recommended	Max. 246 ft / 75 m recommended

	NuQ152-AN (WH)	NuQ115B-AN (WH)	NuQ118B-AN (WH)
Power Supply			
Power consumption	90 W @ 1/8 max power	180 W @ 1/8 max power	180 W @ 1/8 max power
Voltage (fuses)			
USA / Canada	120 V~, 60 Hz (T 15 A H 250 V)	120 V~, 60 Hz (T 15 A H 250 V)	120 V~, 60 Hz (T 15 A H 250 V)
UK / Australia / Europe	220-240 V~, 50/60 Hz (T 10 A H 250 V)	220-240 V~, 50/60 Hz (T 10 A H 250 V)	220-240 V~, 50/60 Hz (T 10 A H 250 V)
Korea / China	220-240 V~, 50/60 Hz (T 10 A H 250 V)	220-240 V~, 50/60 Hz (T 10 A H 250 V)	220-240 V~, 50/60 Hz (T 10 A H 250 V)
Japan	100 V~, 50/60 Hz (T 15 A H 250 V)	100 V~, 50/60 Hz (T 15 A H 250 V)	100 V~, 50/60 Hz (T 15 A H 250 V)
Enclosure			
Dimensions HWD	712 x 430 x 385 mm (28.0 x 16.9 x 15.2")	520 x 580 x 620 mm (20.4 x 22.8 x 24.4")	770 x 580 x 700 mm (30.3 x 22.8 x 27.5")
Net weight	23.6 kg (52.0 lbs)	37 kg (81.5 lbs)	57.9 kg (127.6 lbs)
Construction	15 mm (5/8") birch plywood	18 mm (3/4") birch plywood	18 mm (3/4") birch plywood
Finish	Semi matt black paint	Semi matt black paint	Semi matt black paint
Grille	Powder coated perforated steel	Powder coated perforated steel	Powder coated perforated steel
Flying hardware	M10 x 8 points	M10 x 16 points	M10 x 16 points
Accessories			
	NUQ152-FY flying yoke for NuQ152		

*independent of limiters and driver protection circuits

Only qualified personnel are allowed to modify the AC-Main cord and to adhere to all applicable national standards.

EN Other important information

EN Important information

1. Register online. Please register your new MUSIC Group equipment right after you purchase it by visiting [turbosound.com](https://www.turbosound.com). Registering your purchase using our simple online form helps us to process your repair claims more quickly and efficiently. Also, read the terms and conditions of our warranty, if applicable.

2. Malfunction. Should your MUSIC Group Authorized Reseller not be located in your vicinity, you may contact the MUSIC Group Authorized Fulfiller for your country listed under "Support" at [turbosound.com](https://www.turbosound.com). Should your country not be listed, please check if your problem can be dealt with by our "Online Support" which may also be found under "Support" at [turbosound.com](https://www.turbosound.com). Alternatively, please submit an online warranty claim at [turbosound.com](https://www.turbosound.com) BEFORE returning the product.

3. Power Connections. Before plugging the unit into a power socket, please make sure you are using the correct mains voltage for your particular model. Faulty fuses must be replaced with fuses of the same type and rating without exception.

FEDERAL COMMUNICATIONS COMMISSION COMPLIANCE INFORMATION

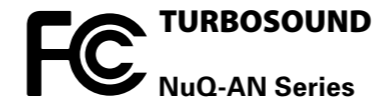

Responsible Party Name: **MUSIC Group Services NV Inc.**

Address: **5270 Procyon Street
Las Vegas, NV 89118
USA**

Phone Number: **+1 702 800 8290**

NuQ-AN Series

This equipment has been tested and found to comply with the limits for a Class B digital device, pursuant to part 15 of the FCC Rules. These limits are designed to provide reasonable protection against harmful interference in a residential installation. This equipment generates, uses and can radiate radio frequency energy and, if not installed and used in accordance with the instructions, may cause harmful interference to radio communications. However, there is no guarantee that interference will not occur in a particular installation. If this equipment does cause harmful interference to radio or television reception, which can be determined by turning the equipment off and on, the user is encouraged to try to correct the interference by one or more of the following measures:

- Reorient or relocate the receiving antenna.
- Increase the separation between the equipment and receiver.
- Connect the equipment into an outlet on a circuit different from that to which the receiver is connected.
- Consult the dealer or an experienced radio/TV technician for help.

This equipment complies with Part 15 of the FCC Rules. Operation is subject to the following two conditions:

- (1) This device may not cause harmful interference, and
- (2) This device must accept any interference received, including interference that may cause undesired operation.

Important information:

Changes or modifications to the equipment not expressly approved by MUSIC Group can void the user's authority to use the equipment.

