

Portable Speakers

iX15

1000 Watt 2 Way 15" Powered Loudspeaker with KLARK TEKNIK DSP Technology, Remote Control via iPhone/iPad and Bluetooth Audio Streaming

- 2 way full range, powered loudspeaker for portable PA applications
- 1000 Watt power featuring KLARK TEKNIK Class-D technology
- KLARK TEKNIK Digital Signal Processing for total system control
- Comprehensive remote control via Apple* iPhone*/iPad*
- High quality Bluetooth* stereo audio streaming
- Remote control 3 channel digital mixer with gain setting recall
- DSP presets for application type and speaker positioning
- 15" low frequency driver with low mass voice coil for improved transient response
- Titanium dome 1" compression driver for extended high frequency reproduction
- Intuitive single rotary control user interface with LCD display for ease of navigation
- Durable lightweight molded enclosure
- Rugged powder coated perforated steel mesh grille
- Dual angle pole mount for accurate audience coverage
- 3-Year Warranty Program*
- Designed and engineered in England



The 1000-Watt iX15 is a powered two-way 15" loudspeaker with Bluetooth* audio streaming ideally suited for a wide range of portable and fixed music and speech sound reinforcement applications. A state-of-the-art KLARK TEKNIK DSP controls the built-in 3-channel digital mixer via a single-knob user interface, as well as providing comprehensive wireless remote control via dedicated app for iPhone/iPad. The iX15's powerful 15" low frequency driver and 1" titanium dome compression driver ensure highest-quality low end, extended high frequency reproduction and articulate midrange reproduction.



The iX15 is fitted with a dual angle pole mount socket, allowing it to be pole mounted straight on, or raised higher and angled downwards to optimise audience coverage. The lightweight fibre glass reinforced composite enclosure is fitted with a rugged powder coated perforated steel mesh grille.

*Apple, iPhone and iPad are trademarks of Apple Inc. The Bluetooth word mark and logos are registered trademarks owned by Bluetooth SIG, Inc. and any use of such marks is under license. All third-party trademarks are the property of their respective owners. Their use neither constitutes a claim of the trademark nor affiliation of the trademark owners with MUSIC Group. Product names are mentioned solely as a reference for compatibility, effects and/or components. Warranty details can be found at music-group.com.

Portable Speakers

iX15

1000 Watt 2 Way 15" Powered Loudspeaker
with KLARK TEKNIK DSP Technology,
Remote Control via iPhone/iPad and
Bluetooth Audio Streaming

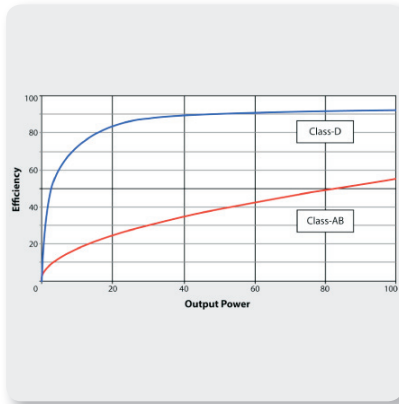

Class-D – 1000 Watts of Perfect Sound

Thanks to our revolutionary Class-D amplifier technology, we are able to provide enormous power and incredible sonic performance in an easy-to-use, ultra-portable and lightweight package. Class-D amplification makes all the difference, offering the ultimate in energy efficiency and eliminating the need for heavy power supplies and massive heat sinks. This amazing technology makes it possible to design and build extremely powerful products that are significantly lighter in weight than their traditional counterparts, while using less energy and protecting the environment. The lightweight Switch Mode Power Supply, coupled with the industry-leading **KLARK TEKNIK** Digital Signal Processing (DSP) module, provides dynamic equalisation and sophisticated limiting functions, ensuring optimal performance and long-term reliability. An efficient and lightweight **KLARK TEKNIK** Class-D power amplifier provides the iX15's bi-amplified 1000-Watt output.

KLARK TEKNIK DSP – the Secret to Superb Sound

KLARK TEKNIK is recognised worldwide as one of the most prestigious British audio companies, with a 40-year pedigree and a TEC Lifetime Achievement Award to back it up. The Company has designed and manufactured products for world-class artists, and their legendary DN780 reverb processor is considered by leading audio engineers around the world as the industry standard. Check out their website to learn more about **KLARK TEKNIK**'s legendary heritage.

TURBOSOUND is proud to incorporate custom-engineered **KLARK TEKNIK** DSP into their products. From the instant your signal enters the iX15, the built-in DSP (Digital Signal Processor) takes over, ensuring the highest possible signal integrity. Much more than just selective EQ enhancement, the iX15's 24-bit DSP analyses the incoming signal and intelligently applies specific filters to actually improve the sound quality. It is very much like having an audio engineer monitoring the input and output signals of each iX15, dialing in the perfect EQ and constantly making subtle adjustments to the crossover, compressor/limiter and more – which all adds up to significantly better sound.

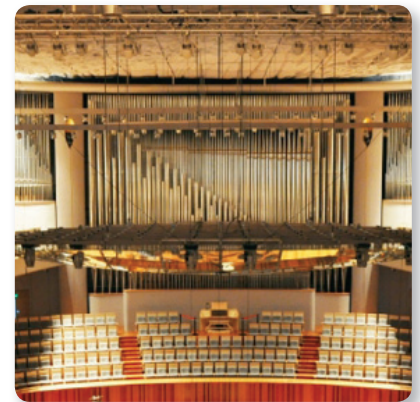

Portable Speakers

iX15

1000 Watt 2 Way 15" Powered Loudspeaker
with KLARK TEKNIK DSP Technology,
Remote Control via iPhone/iPad and
Bluetooth Audio Streaming

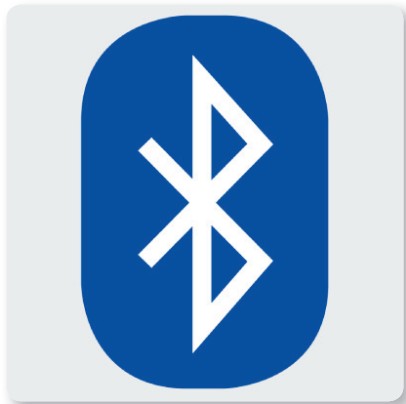

Bluetooth Ready

The days of tape decks, CD and even mp3 players are long gone. Now your music lives on your smartphone or computer tablet, so you can stop searching for those outdated cables and fancy adapters. An industry first, the iX15 puts all your music at your fingertips via stereo Bluetooth. Now with a simple wave of your hand, you can stream music from any Bluetooth-equipped iOS device, such as your iPad, iPhone – or even your laptop computer.

Comprehensive Remote Control

We take Bluetooth a step further, giving you total control of the iX15 directly from you iPhone or iPad. This amazing feature lets you adjust all settings from either the listening area or the stage, for the perfect sound every time. The iX15 Bluetooth app even allows the user to define one iX15 as the master, and the other as the slave – so the music stream is presented in true stereo. The dedicated apps are available free of charge at turbosound.com, or from the Apple App Store.

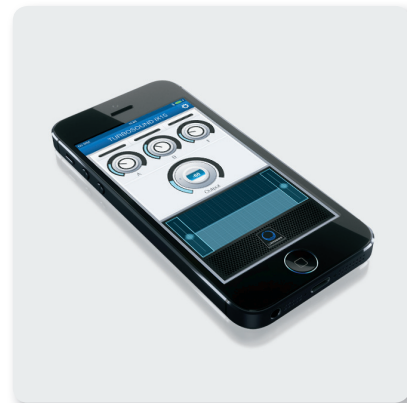

Custom-Engineered Drivers

Powerful, high-efficiency Class-D amplifiers and Switch Mode Power Supply technology coupled with state-of-the-art DSP functionality sounds very impressive – but what about the part of the system you actually hear? We are known internationally for making some of the best-sounding speaker systems in the world, so we take our drivers (woofers and tweeters) very seriously. Our LF and HF drivers are designed specifically for each application – it is what sets us apart from the competition. When you buy an iX15 loudspeaker, you can rest assured the genuine **TURBOSOUND** 15" LF driver with low mass voice coil, and 1" exit titanium dome compression driver have been engineered to perform flawlessly in conjunction with every other element for truly professional results.

Portable Speakers

iX15

1000 Watt 2 Way 15" Powered Loudspeaker
with KLARK TEKNIK DSP Technology,
Remote Control via iPhone/iPad and
Bluetooth Audio Streaming

Intuitive User Interface

On the rear panel amplifier module, you will find a fully featured user interface consisting of an LCD display and single rotary encoder for intuitive access to level, EQ, and frequency response presets for pole or stand-mounted front of house, or floor monitor scenarios. In addition to the two combination balanced XLR/jack inputs, an XLR Output is provided for daisy-chaining more active loudspeakers, or for use with an active subwoofer.



Stunning Performance – Superb Value

The iX15 active PA loudspeaker stands head and shoulders above the rest of the pack and delivers exceptional performance, even when pushed to the limit. Ultra-lightweight and powerful with custom-designed transducers, an integrated mixer, stereo Bluetooth streaming, iPhone/iPad remote control, 1000 Watts of KLARK TEKNIK's Class-D output power and Digital Sound Processing, the iX15 is ideal for both portable and installed applications – at a price unheard of in this class.

Experience the iX15 at your local dealer today, or get yours online today – and let TURBOSOUND take your performance to the next level!

You Are Covered

We always strive to provide the best possible Customer Experience. Our products are made in our own MUSIC Group factory using state-of-the-art automation, enhanced production workflows and quality assurance labs with the most sophisticated test equipment available in the world. As a result, we have one of the lowest product failure rates in the industry, and we confidently back it up with a generous 3-Year Warranty program.



Portable Speakers

iX15

1000 Watt 2 Way 15" Powered Loudspeaker
with KLARK TEKNIK DSP Technology,
Remote Control via iPhone/iPad and
Bluetooth Audio Streaming

Frequency Response Sensitivity 1 W / 1 m

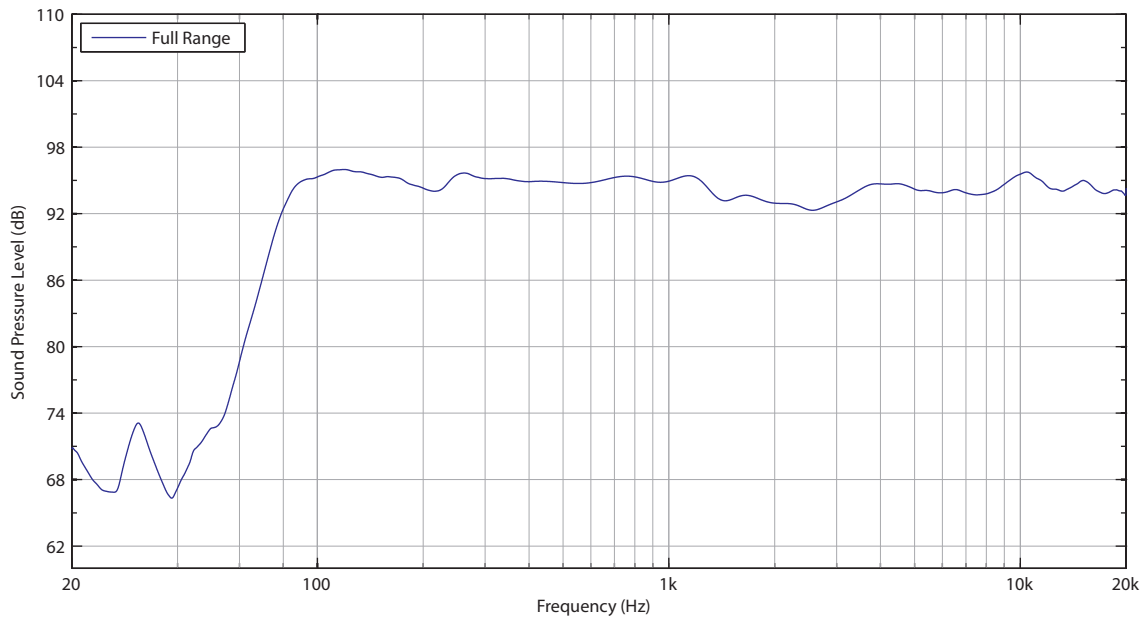

Portable Speakers

iX15

1000 Watt 2 Way 15" Powered Loudspeaker
with KLARK TEKNIK DSP Technology,
Remote Control via iPhone/iPad and
Bluetooth Audio Streaming

Horizontal Beamwidth

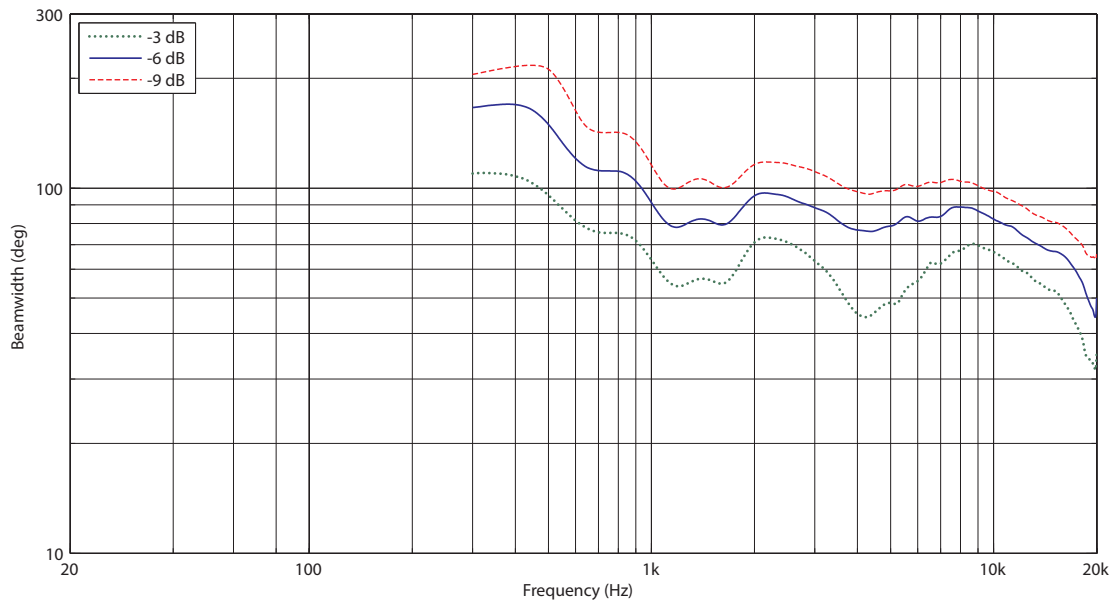

Vertical Beamwidth

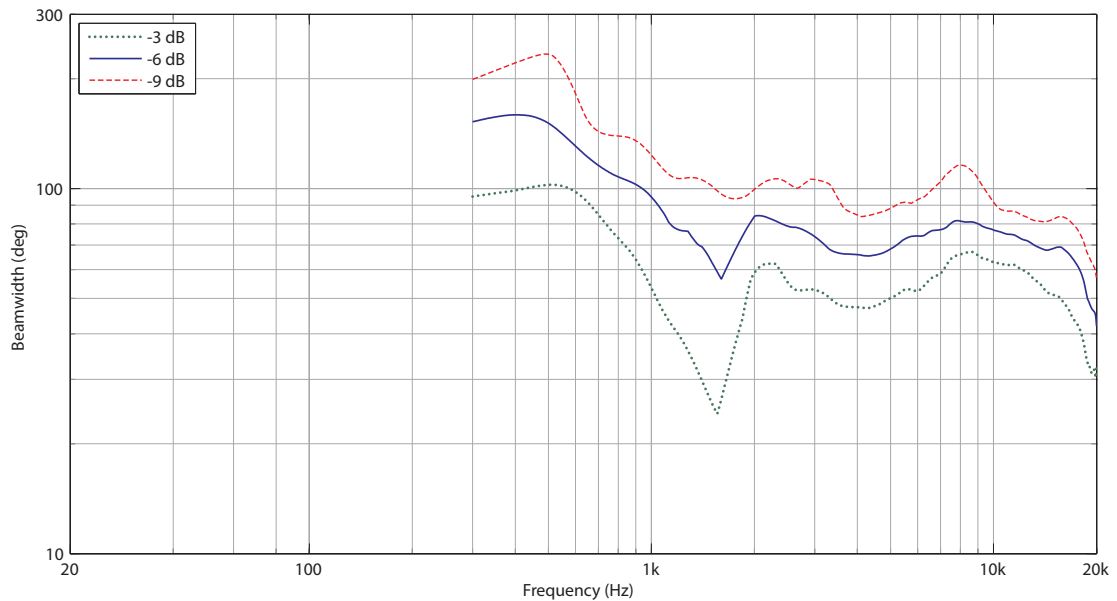

Portable Speakers

iX15

1000 Watt 2 Way 15" Powered Loudspeaker
with KLARK TEKNIK DSP Technology,
Remote Control via iPhone/iPad and
Bluetooth Audio Streaming

Horizontal Polar Plots

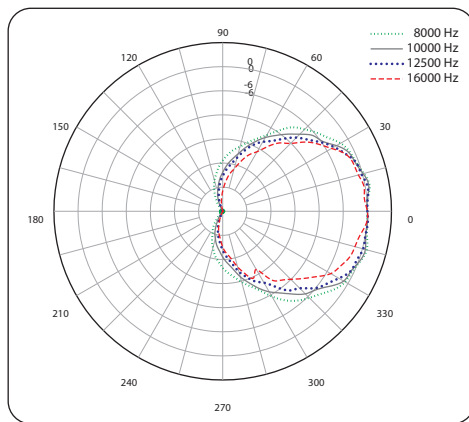
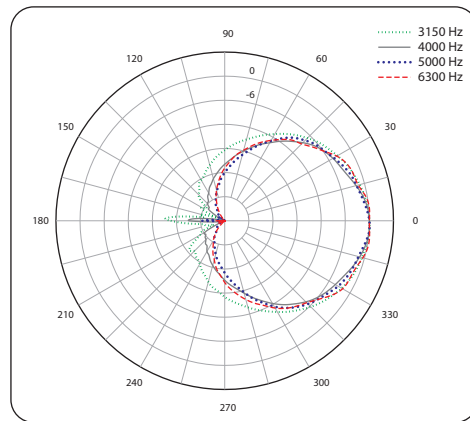
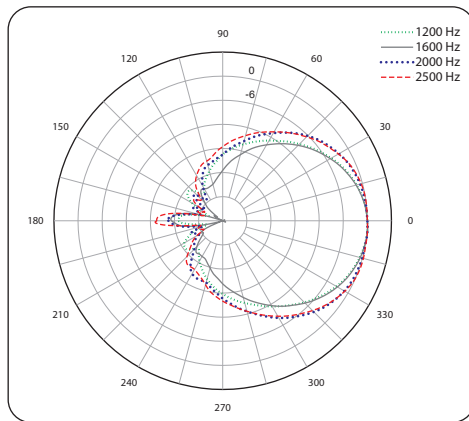
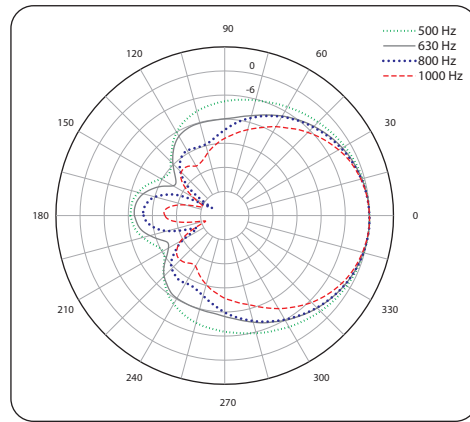
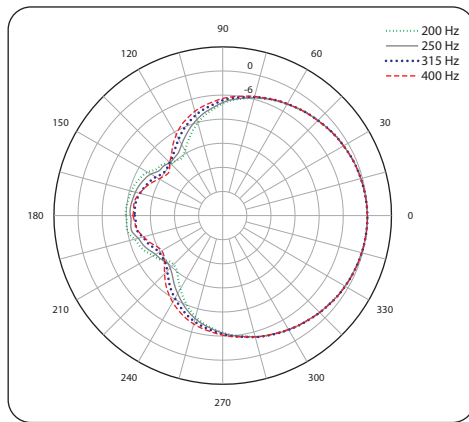

Portable Speakers

iX15

1000 Watt 2 Way 15" Powered Loudspeaker
with KLARK TEKNIK DSP Technology,
Remote Control via iPhone/iPad and
Bluetooth Audio Streaming

Vertical Polar Plots

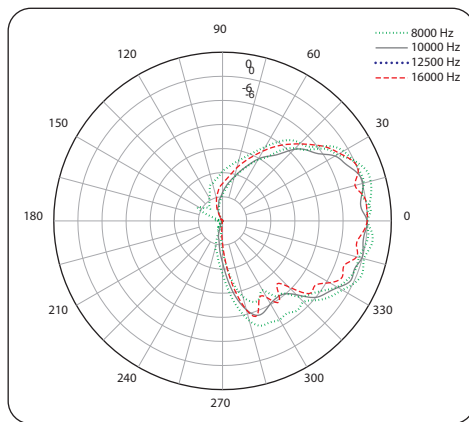
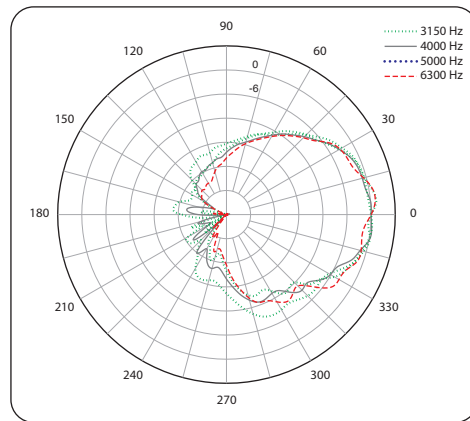
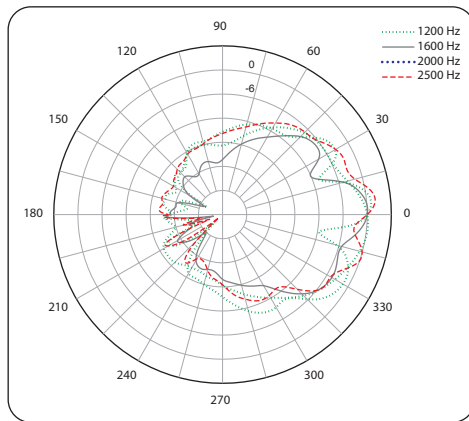
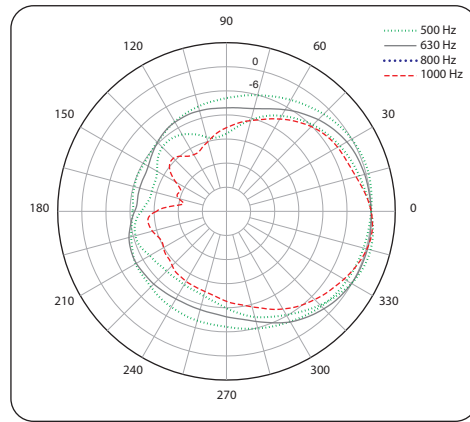
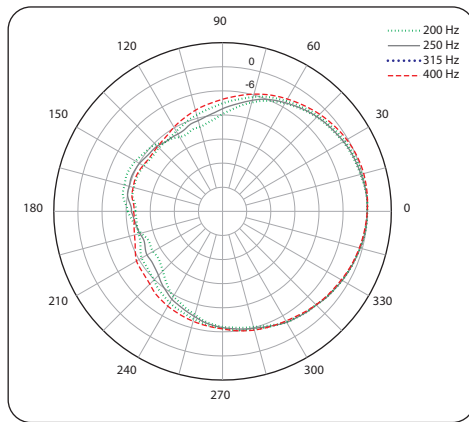

Portable Speakers

iX15

1000 Watt 2 Way 15" Powered Loudspeaker
with KLARK TEKNIK DSP Technology,
Remote Control via iPhone/iPad and
Bluetooth Audio Streaming

Dimensions

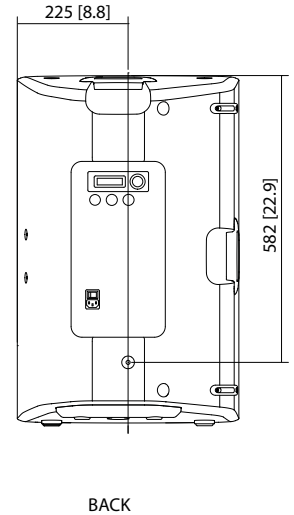
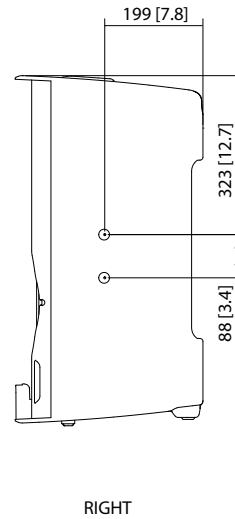
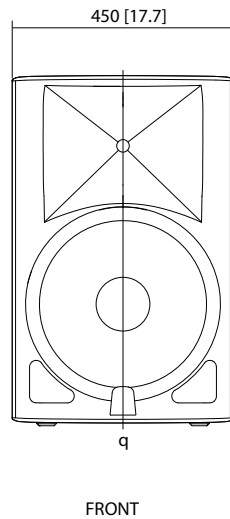
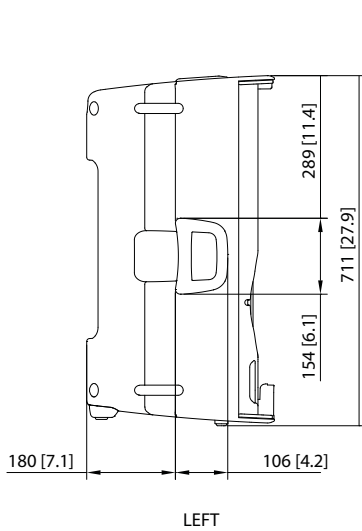
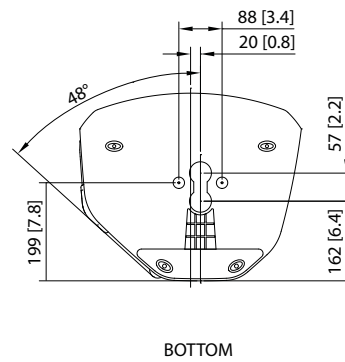
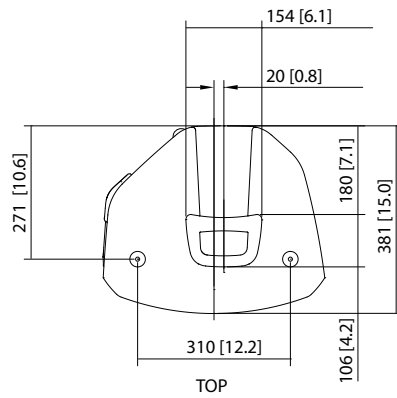

Portable Speakers

iX15

1000 Watt 2 Way 15" Powered Loudspeaker
with KLARK TEKNIK DSP Technology,
Remote Control via iPhone/iPad and
Bluetooth Audio Streaming

Technical Specifications

System

Frequency response	45 Hz – 20 kHz \pm 3 dB 39 Hz – 20 kHz -10 dB
Nominal dispersion	75° H x 55° V @ -6 dB points
Maximum SPL	126 dB
Crossover type	Active
Transducers	1 x 15" (387 mm) LF driver 1 x 1" (25.4 mm) HF compression driver
Limiter	Independent HF, LF

Amplifier

Maximum output power*	1000 W
Type	LF: Class-D HF: Class AB
Protection	Short circuit, open circuit, thermal

Connectors

Input A / B	2 x combo jack / XLR
Sensitivity for max out with volume control at 0dB	+4 dBu
Input impedance	16 k Ω unbalanced, 33 k Ω balanced
Maximum input level	+22 dBu
Output	XLR, servo-balanced
Output impedance	220 Ω unbalanced, 600 Ω balanced
Mains Supply	IEC mains connector with integrated power switch†

Controls

Hardware	Rotary push-encoder
Software	iOS interface via bluetooth

User DSP Functions

Factory EQ presets	Positioning, Sound mode, Phase
Display	LCD 128 x 32, blue, backlit
Equalisation	Bass and treble controls
Crossover	High pass L-R 24 dB/oct
Protection	Lock-out function for all settings

Bluetooth Wireless Technology

Frequency range	2402 MHz ~ 2480 MHz
Channel number	79
Version	Bluetooth 4.0 dual mode
Output	8 dBm
Compatibility	Supports A2DP 1.2 profile, BLE
Maximum communication range	35 m (without interference)
Connectivity	Master-slave: stereo pairing link

Portable Speakers

iX15

1000 Watt 2 Way 15" Powered Loudspeaker
with KLARK TEKNIK DSP Technology,
Remote Control via iPhone/iPad and
Bluetooth Audio Streaming

Power Supply

Power consumption	80 W @ 1/8 max power
--------------------------	----------------------

Voltage

USA / Canada	120 V~, 60 Hz
--------------	---------------

UK / Australia / Europe	220-240 V~, 50/60 Hz
-------------------------	----------------------

Korea / China	220-240 V~, 50/60 Hz
---------------	----------------------

Japan	100 V~, 50/60 Hz
-------	------------------

Enclosure

Dimensions (H x W x D)	711 x 450 x 381 mm (27.9 x 17.7 x 15.0")
-------------------------------	--

Net weight	22.4 kg (49.4 lbs)
-------------------	--------------------

Construction	Injection-moulded polypropylene enclosure
---------------------	---

Finish	Black paint
---------------	-------------

Grille	Powder coated perforated steel
---------------	--------------------------------

Flying hardware	–
------------------------	---

*independent of limiters and driver protection circuits

†Only qualified personnel are allowed to modify the AC-Main cord and to adhere to all applicable national standards.

Portable Speakers

iX15

1000 Watt 2 Way 15" Powered Loudspeaker
with KLARK TEKNIK DSP Technology,
Remote Control via iPhone/iPad and
Bluetooth Audio Streaming



Portable Speakers

iX15

1000 Watt 2 Way 15" Powered Loudspeaker
with KLARK TEKNIK DSP Technology,
Remote Control via iPhone/iPad and
Bluetooth Audio Streaming



Portable Speakers

iX15

1000 Watt 2 Way 15" Powered Loudspeaker
with KLARK TEKNIK DSP Technology,
Remote Control via iPhone/iPad and
Bluetooth Audio Streaming



Portable Speakers

iX15

1000 Watt 2 Way 15" Powered Loudspeaker
with KLARK TEKNIK DSP Technology,
Remote Control via iPhone/iPad and
Bluetooth Audio Streaming



Year Warranty

For service, support or more information contact the TURBOSOUND location nearest you:

Europe
MUSIC Group Services UK
Tel: +44 156 273 2290
Email: CARE@music-group.com

USA/Canada
MUSIC Group Services NV Inc.
Tel: +1 702 800 8290
Email: CARE@music-group.com

Japan
MUSIC Group Services JP K.K.
Tel: +81 3 6231 0454
Email: CARE@music-group.com

MUSIC Group accepts no liability for any loss which may be suffered by any person who relies either wholly or in part upon any description, photograph, or statement contained herein. Technical specifications, appearances and other information are subject to change without notice. All trademarks are the property of their respective owners. MIDAS, KLARK TEKNIK, LAB GRUPPEN, LAKE, TANNÖY, TURBOSOUND, TC ELECTRONIC, TC HELICON, BEHRINGER, BUGERA and DDA are trademarks or registered trademarks of MUSIC Group IP Ltd.
© MUSIC Group IP Ltd. 2016 All rights reserved.