

Quick Start Guide

EN

ES

FR

DE

PT



iQ Series

2500 Watt 2 Way 8"/10"/12"/15" Powered Loudspeaker 3000 Watt 15"/18" Powered Subwoofer
KLARK TEKNIK DSP Technology, Speaker Modelling and ULTRANET Networking

EN

EN Important Safety Instructions



Terminals marked with this symbol carry electrical current of sufficient magnitude to constitute risk of electric shock.

Use only high-quality professional speaker cables with ¼" TS or twist-locking plugs pre-installed. All other installation or modification should be performed only by qualified personnel.



This symbol, wherever it appears, alerts you to the presence of uninsulated dangerous voltage inside the enclosure - voltage that may be sufficient to constitute a risk of shock.



This symbol, wherever it appears, alerts you to important operating and maintenance instructions in the accompanying literature. Please read the manual.



Caution

To reduce the risk of electric shock, do not remove the top cover (or the rear section). No user serviceable parts inside. Refer servicing to qualified personnel.



Caution

To reduce the risk of fire or electric shock, do not expose this appliance to rain and moisture. The apparatus shall not be exposed to dripping or splashing liquids and no objects filled with liquids, such as vases, shall be placed on the apparatus.



Caution

These service instructions are for use by qualified service personnel only. To reduce the risk of electric shock do not perform any servicing other than that contained in the operation instructions. Repairs have to be performed by qualified service personnel.

1. Read these instructions.
2. Keep these instructions.
3. Heed all warnings.
4. Follow all instructions.
5. Do not use this apparatus near water.
6. Clean only with dry cloth.
7. Do not block any ventilation openings. Install in accordance with the manufacturer's instructions.
8. Do not install near any heat sources such as radiators, heat registers, stoves, or other apparatus (including amplifiers) that produce heat.

9. Do not defeat the safety purpose of the polarized or grounding-type plug. A polarized plug has two blades with one wider than the other. A grounding-type plug has two blades and a third grounding prong. The wide blade or the third prong are provided for your safety. If the provided plug does not fit into your outlet, consult an electrician for replacement of the obsolete outlet.

10. Protect the power cord from being walked on or pinched particularly at plugs, convenience receptacles, and the point where they exit from the apparatus.

11. Use only attachments/accessories specified by the manufacturer.



12. Use only with the cart, stand, tripod, bracket, or table specified by the manufacturer, or sold with the apparatus. When a cart is used, use caution when moving the cart/apparatus combination to avoid

injury from tip-over.

13. Unplug this apparatus during lightning storms or when unused for long periods of time.

14. Refer all servicing to qualified service personnel. Servicing is required when the apparatus has been damaged in any way, such as power supply cord or plug is damaged, liquid has been spilled or objects have fallen into the apparatus, the apparatus has been exposed to rain or moisture, does not operate normally, or has been dropped.

15. The apparatus shall be connected to a MAINS socket outlet with a protective earthing connection.

16. Where the MAINS plug or an appliance coupler is used as the disconnect device, the disconnect device shall remain readily operable.



17. Correct disposal of this product: This symbol indicates that this product must not be disposed of with household waste, according to the WEEE Directive (2012/19/EU) and your national law. This product should be taken

to a collection center licensed for the recycling of waste electrical and electronic equipment (EEE). The mishandling of this type of waste could have a possible negative impact on the environment and human health due to potentially hazardous substances that are generally associated with EEE. At the same time, your cooperation in the correct disposal of this product will contribute to the efficient use of natural resources. For more information about where you can take your waste equipment for recycling, please contact your local city office, or your household waste collection service.

18. Do not install in a confined space, such as a book case or similar unit.

19. Do not place naked flame sources, such as lighted candles, on the apparatus.

20. Please keep the environmental aspects of battery disposal in mind. Batteries must be disposed of at a battery collection point.

21. Use this apparatus in tropical and/or moderate climates.

LEGAL DISCLAIMER

Music Tribe accepts no liability for any loss which may be suffered by any person who relies either wholly or in part upon any description, photograph, or statement contained herein. Technical specifications, appearances and other information are subject to change without notice. All trademarks are the property of their respective owners. Midas, Klark Teknik, Lab Gruppen, Lake, Tannoy, Turbosound, TC Electronic, TC Helicon, Behringer, Bugera and Coolaudio are trademarks or registered trademarks of Music Tribe Global Brands Ltd. © Music Tribe Global Brands Ltd. 2019 All rights reserved.

LIMITED WARRANTY

For the applicable warranty terms and conditions and additional information regarding Music Tribe's Limited Warranty, please see complete details online at musictribe.com/warranty.

Zhongshan Eurotec Electronics Limited

No. 10 Wanmei Road, South China Modern Chinese Medicine Park, Nanlang Town, 528451, Zhongshan City, Guangdong Province, China

ES Instrucciones de seguridad



Las terminales marcadas con este símbolo transportan corriente eléctrica de magnitud suficiente como para constituir un riesgo de descarga eléctrica. Utilice solo cables de altavoz profesionales y de alta calidad con conectores TS de 6,3 mm o de bayoneta prefijados. Cualquier otra instalación o modificación debe ser realizada únicamente por un técnico cualificado.



Este símbolo, siempre que aparece, le advierte de la presencia de voltaje peligroso sin aislar dentro de la caja; este voltaje puede ser suficiente para constituir un riesgo de descarga.



Este símbolo, siempre que aparece, le advierte sobre instrucciones operativas y de mantenimiento que aparecen en la documentación adjunta. Por favor, lea el manual.



Atención

Para reducir el riesgo de descarga eléctrica, no quite la tapa (o la parte posterior). No hay piezas en el interior del equipo que puedan ser reparadas por el usuario. Si es necesario, póngase en contacto con personal cualificado.



Atención

Para reducir el riesgo de incendio o descarga eléctrica, no exponga este aparato a la lluvia, humedad o alguna otra fuente que pueda salpicar o derramar algún líquido sobre el aparato. No coloque ningún tipo de recipiente para líquidos sobre el aparato.



Atención

Las instrucciones de servicio deben llevarlas a cabo exclusivamente personal cualificado. Para evitar el riesgo de una descarga eléctrica, no realice reparaciones que no se encuentren descritas en el manual de operaciones. Las reparaciones deben ser realizadas exclusivamente por personal cualificado.

1. Lea las instrucciones.
2. Conserve estas instrucciones.
3. Preste atención a todas las advertencias.
4. Siga todas las instrucciones.
5. No use este aparato cerca del agua.
6. Limpie este aparato con un paño seco.
7. No bloquee las aberturas de ventilación. Instale el equipo de acuerdo con las instrucciones del fabricante.
8. No instale este equipo cerca de fuentes de calor tales como radiadores, acumuladores de calor, estufas u otros aparatos (incluyendo amplificadores) que puedan producir calor.

9. No elimine o deshabilite nunca la conexión a tierra del aparato o del cable de alimentación de corriente. Un enchufe polarizado tiene dos polos, uno de los cuales tiene un contacto más ancho que el otro. Una clavija con puesta a tierra dispone de tres contactos: dos polos y la puesta a tierra. El contacto ancho y el tercer contacto, respectivamente, son los que garantizan una mayor seguridad. Si el enchufe suministrado con el equipo no concuerda con la toma de corriente, consulte con un electricista para cambiar la toma de corriente obsoleta.

10. Coloque el cable de suministro de energía de manera que no pueda ser pisado y que esté protegido de objetos afilados. Asegúrese de que el cable de suministro de energía esté protegido, especialmente en la zona de la clavija y en el punto donde sale del aparato.

11. Use únicamente los dispositivos o accesorios especificados por el fabricante.



12. Use únicamente la carretilla, plataforma, trípode, soporte o mesa especificados por el fabricante o suministrados junto con el equipo. Al transportar el equipo, tenga cuidado para evitar daños y caídas al tropezar con algún obstáculo.

13. Desenchufe el equipo durante tormentas o si no va a utilizarlo durante un periodo largo.

14. Confíe las reparaciones únicamente a servicios técnicos cualificados. La unidad requiere mantenimiento siempre que haya sufrido algún daño, si el cable de suministro de energía o el enchufe presentaran daños, se hubiera derramado un líquido o hubieran caído objetos dentro del equipo, si el aparato hubiera estado expuesto a la humedad o la lluvia, si ha dejado de funcionar de manera normal o si ha sufrido algún golpe o caída.

15. Al conectar la unidad a la toma de corriente eléctrica asegúrese de que la conexión disponga de una unión a tierra.

16. Si el enchufe o conector de red sirve como único medio de desconexión, éste debe ser accesible fácilmente.



17. Cómo debe deshacerse de este aparato: Este símbolo indica que este aparato no debe ser tratado como basura orgánica, según lo indicado en la Directiva WEEE (2012/19/EU) y a las normativas aplicables en su país.

En lugar de ello deberá llevarlo al punto limpio más cercano para el reciclaje de sus elementos eléctricos / electrónicos (EEE). Al hacer esto estará ayudando a prevenir las posibles consecuencias negativas para el medio ambiente y la salud que podrían ser provocadas por una gestión inadecuada de este tipo de aparatos. Además, el reciclaje de materiales ayudará a conservar los recursos naturales. Para más información acerca del reciclaje de este aparato, póngase en contacto con el Ayuntamiento de su ciudad o con el punto limpio local.

18. No instale esta unidad en un espacio muy reducido, tal como encastrada en una librería o similar.

19. No coloque objetos con llama, como una vela encendida, sobre este aparato.

20. Tenga presentes todas las advertencias relativas al reciclaje y correcta eliminación de las pilas. Las pilas deben ser siempre eliminadas en un punto limpio y nunca con el resto de la basura orgánica.

21. Use este aparato en rangos de temperatura moderados y/o tropicales.

NEGACIÓN LEGAL

Music Tribe no admite ningún tipo de responsabilidad por cualquier daño o pérdida que pudiera sufrir cualquier persona por confiar total o parcialmente en la descripciones, fotografías o afirmaciones contenidas en este documento. Las especificaciones técnicas, imágenes y otras informaciones contenidas en este documento están sujetas a modificaciones sin previo aviso. Todas las marcas comerciales que aparecen aquí son propiedad de sus respectivos dueños. Midas, Klark Teknik, Lab Gruppen, Lake, Tannoy, Turbosound, TC Electronic, TC Helicon, Behringer, Bugera y Coolaudio son marcas comerciales o marcas registradas de Music Tribe Global Brands Ltd. © Music Tribe Global Brands Ltd. 2019 Reservados todos los derechos.

GARANTÍA LIMITADA

Si quiere conocer los detalles y condiciones aplicables de la garantía así como información adicional sobre la Garantía limitada de Music Tribe, consulte online toda la información en la web musictribe.com/warranty.

EN

ES

FR Consignes de sécurité

Les points repérés par ce symbole portent une tension électrique suffisante pour constituer un risque d'électrocution.

Utilisez uniquement des câbles d'enceintes professionnels de haute qualité avec fiches Jack mono 6,35 mm ou fiches à verrouillages déjà installées. Toute autre installation ou modification doit être effectuée uniquement par un personnel qualifié.



Ce symbole avertit de la présence d'une tension dangereuse et non isolée à l'intérieur de l'appareil - elle peut provoquer des chocs électriques.

**Attention**

Ce symbole signale les consignes d'utilisation et d'entretien ! Tien importantes dans la documentation fournie. Lisez les consignes de sécurité du manuel d'utilisation de l'appareil.

**Attention**

Pour éviter tout risque de choc électrique, ne pas ouvrir le capot de l'appareil ni démonter le panneau arrière. L'intérieur de l'appareil ne possède aucun élément réparable par l'utilisateur. Laisser toute réparation à un professionnel qualifié.

**Attention**

Pour réduire les risques de feu et de choc électrique, n'exposez pas cet appareil à la pluie, à la moisissure, aux gouttes ou aux éclaboussures. Ne posez pas de récipient contenant un liquide sur l'appareil (un vase par exemple).

**Attention**

Ces consignes de sécurité et d'entretien sont destinées à un personnel qualifié. Pour éviter tout risque de choc électrique, n'effectuez aucune réparation sur l'appareil qui ne soit décrite par le manuel d'utilisation. Les éventuelles réparations doivent être effectuées uniquement par un technicien spécialisé.

1. Lisez ces consignes.
2. Conservez ces consignes.
3. Respectez tous les avertissements.
4. Respectez toutes les consignes d'utilisation.
5. N'utilisez jamais l'appareil à proximité d'un liquide.
6. Nettoyez l'appareil avec un chiffon sec.
7. Veillez à ne pas empêcher la bonne ventilation de l'appareil via ses ouïes de ventilation. Respectez les consignes du fabricant concernant l'installation de l'appareil.
8. Ne placez pas l'appareil à proximité d'une source de chaleur telle qu'un chauffage, une cuisinière ou tout appareil dégageant de la chaleur (y compris un ampli de puissance).

9. Ne supprimez jamais la sécurité des prises bipolaires ou des prises terre. Les prises bipolaires possèdent deux contacts de largeur différente. Le plus large est le contact de sécurité. Les prises terre possèdent deux contacts plus une mise à la terre servant de sécurité. Si la prise du bloc d'alimentation ou du cordon d'alimentation fourni ne correspond pas à celles de votre installation électrique, faites appel à un électricien pour effectuer le changement de prise.

10. Installez le cordon d'alimentation de telle façon que personne ne puisse marcher dessus et qu'il soit protégé d'arêtes coupantes. Assurez-vous que le cordon d'alimentation est suffisamment protégé, notamment au niveau de sa prise électrique et de l'endroit où il est relié à l'appareil; cela est également valable pour une éventuelle rallonge électrique.

11. Utilisez exclusivement des accessoires et des appareils supplémentaires recommandés par le fabricant.



12. Utilisez exclusivement des chariots, des diables, des présentoirs, des pieds et des surfaces de travail recommandés par le fabricant ou livrés avec le produit.

Déplacez précautionneusement tout chariot ou diable chargé pour éviter d'éventuelles blessures en cas de chute.

13. Débranchez l'appareil de la tension secteur en cas d'orage ou si l'appareil reste inutilisé pendant une longue période de temps.

14. Les travaux d'entretien de l'appareil doivent être effectués uniquement par du personnel qualifié. Aucun entretien n'est nécessaire sauf si l'appareil est endommagé de quelque façon que ce soit (dommages sur le cordon d'alimentation ou la prise par exemple), si un liquide ou un objet a pénétré à l'intérieur du châssis, si l'appareil a été exposé à la pluie ou à l'humidité, s'il ne fonctionne pas correctement ou à la suite d'une chute.

15. L'appareil doit être connecté à une prise secteur dotée d'une protection par mise à la terre.

16. La prise électrique ou la prise IEC de tout appareil dénué de bouton marche/arrêt doit rester accessible en permanence.



17. Mise au rebut appropriée de ce produit: Ce symbole indique qu'en accord avec la directive DEEE (2012/19/EU) et les lois en vigueur dans votre pays, ce produit ne doit pas être jeté avec les déchets ménagers. Ce produit doit être

déposé dans un point de collecte agréé pour le recyclage des déchets d'équipements électriques et électroniques (EEE). Une mauvaise manipulation de ce type de déchets pourrait avoir un impact négatif sur l'environnement et la santé à cause des substances potentiellement dangereuses généralement associées à ces équipements. En même temps, votre coopération dans la mise au rebut de ce produit contribuera à l'utilisation efficace des ressources naturelles. Pour plus d'informations sur l'endroit où vous pouvez déposer vos déchets

d'équipements pour le recyclage, veuillez contacter votre mairie ou votre centre local de collecte des déchets.

18. N'installez pas l'appareil dans un espace confiné tel qu'une bibliothèque ou meuble similaire.

19. Ne placez jamais d'objets enflammés, tels que des bougies allumées, sur l'appareil.

20. Gardez à l'esprit l'impact environnemental lorsque vous mettez des piles au rebus. Les piles usées doivent être déposées dans un point de collecte adapté.

21. Utilisez l'appareil dans un climat tropical et/ou modéré.

DÉNI LÉGAL

Music Tribe ne peut être tenu pour responsable pour toute perte pouvant être subie par toute personne se fiant en partie ou en totalité à toute description, photographie ou affirmation contenue dans ce document. Les caractéristiques, l'apparence et d'autres informations peuvent faire l'objet de modifications sans notification. Toutes les marques appartiennent à leurs propriétaires respectifs. Midas, Klark Teknik, Lab Gruppen, Lake, Tannoy, Turbosound, TC Electronic, TC Helicon, Behringer, Bugera et Coolaudio sont des marques ou marques déposées de Music Tribe Global Brands Ltd. © Music Tribe Global Brands Ltd. 2019 Tous droits réservés.

GARANTIE LIMITÉE

Pour connaître les termes et conditions de garantie applicables, ainsi que les informations supplémentaires et détaillées sur la Garantie Limitée de Music Tribe, consultez le site Internet musictribe.com/warranty.

DE Wichtige Sicherheitshinweise**Vorsicht**

Die mit dem Symbol markierten Anschlüsse führen so viel Spannung, dass die Gefahr eines Stromschlags besteht.

Verwenden Sie nur hochwertige, professionelle Lautsprecherkabel mit vorinstallierten 6,35 mm MONO-Klinkensteckern oder Lautsprecherstecker mit Drehverriegelung. Alle anderen Installationen oder Modifikationen sollten nur von qualifiziertem Fachpersonal ausgeführt werden.

**Achtung**

Um eine Gefährdung durch Stromschlag auszuschließen, darf die Geräteabdeckung bzw. Geräterückwand nicht abgenommen werden. Im Innern des Geräts befinden sich keine vom Benutzer reparierbaren Teile. Reparaturarbeiten dürfen nur von qualifiziertem Personal ausgeführt werden.

**Achtung**

Um eine Gefährdung durch Feuer bzw. Stromschlag auszuschließen, darf dieses Gerät weder Regen oder Feuchtigkeit ausgesetzt werden noch sollten Spritzwasser oder tropfende Flüssigkeiten in das Gerät gelangen können. Stellen Sie keine mit Flüssigkeit gefüllten Gegenstände, wie z. B. Vasen, auf das Gerät.

**Achtung**

Die Service-Hinweise sind nur durch qualifiziertes Personal zu befolgen. Um eine Gefährdung durch Stromschlag zu vermeiden, führen Sie bitte keinerlei Reparaturen an dem Gerät durch, die nicht in der Bedienungsanleitung beschrieben sind. Reparaturen sind nur von qualifiziertem Fachpersonal durchzuführen.

1. Lesen Sie diese Hinweise.
2. Bewahren Sie diese Hinweise auf.
3. Beachten Sie alle Warnhinweise.
4. Befolgen Sie alle Bedienungshinweise.
5. Betreiben Sie das Gerät nicht in der Nähe von Wasser.
6. Reinigen Sie das Gerät mit einem trockenen Tuch.
7. Blockieren Sie nicht die Belüftungsschlitze. Beachten Sie beim Einbau des Gerätes die Herstellerhinweise.
8. Stellen Sie das Gerät nicht in der Nähe von Wärmequellen auf. Solche Wärmequellen sind z. B. Heizkörper, Herde oder andere Wärme erzeugende Geräte (auch Verstärker).
9. Entfernen Sie in keinem Fall die Sicherheitsvorrichtung von Zweipol- oder geerdeten Steckern. Ein Zweipolstecker hat zwei unterschiedlich breite Steckkontakte. Ein geerdeter Stecker hat zwei Steckkontakte und einen dritten Erdungskontakt. Der breitere Steckkontakt oder der zusätzliche

Erdungskontakt dient Ihrer Sicherheit. Falls das mitgelieferte Steckerformat nicht zu Ihrer Steckdose passt, wenden Sie sich bitte an einen Elektriker, damit die Steckdose entsprechend ausgetauscht wird.

10. Verlegen Sie das Netzkabel so, dass es vor Tritten und scharfen Kanten geschützt ist und nicht beschädigt werden kann. Achten Sie bitte insbesondere im Bereich der Stecker, Verlängerungskabel und an der Stelle, an der das Netzkabel das Gerät verlässt, auf ausreichenden Schutz.

11. Das Gerät muss jederzeit mit intaktem Schutzleiter an das Stromnetz angeschlossen sein.

12. Sollte der Hauptnetzstecker oder eine Gerätesteckdose die Funktionseinheit zum Abschalten sein, muss diese immer zugänglich sein.

13. Verwenden Sie nur Zusatzgeräte/Zubehörteile, die laut Hersteller geeignet sind.



14. Verwenden Sie nur Wagen, Standvorrichtungen, Stative, Halter oder Tische, die vom Hersteller benannt oder im Lieferumfang des Geräts enthalten sind. Falls Sie einen

Wagen benutzen, seien Sie vorsichtig beim Bewegen der Wagen-Gerätkombination, um Verletzungen durch Stolpern zu vermeiden.

15. Ziehen Sie den Netzstecker bei Gewitter oder wenn Sie das Gerät längere Zeit nicht benutzen.

16. Lassen Sie alle Wartungsarbeiten nur von qualifiziertem Service-Personal ausführen. Eine Wartung ist notwendig, wenn das Gerät in irgendeiner Weise beschädigt wurde (z. B. Beschädigung des Netzkabels oder Steckers), Gegenstände oder Flüssigkeit in das Geräterinnere gelangt sind, das Gerät Regen oder Feuchtigkeit ausgesetzt wurde, das Gerät nicht ordnungsgemäß funktioniert oder auf den Boden gefallen ist.



17. Korrekte Entsorgung dieses Produkts: Dieses Symbol weist darauf hin, das Produkt entsprechend der WEEE Richtlinie (2012/19/EU) und der jeweiligen nationalen Gesetze nicht zusammen mit Ihren

Haushaltsabfällen zu entsorgen. Dieses Produkt sollte bei einer autorisierten Sammelstelle für Recycling elektrischer und elektronischer Geräte (EEE) abgegeben werden. Wegen bedenkllicher Substanzen, die generell mit elektrischen und elektronischen Geräten in Verbindung stehen, könnte eine unsachgemäße Behandlung dieser Abfallart eine negative Auswirkung auf Umwelt und Gesundheit haben. Gleichzeitig gewährleistet Ihr Beitrag zur richtigen Entsorgung dieses Produkts die effektive Nutzung natürlicher Ressourcen. Für weitere Informationen zur Entsorgung Ihrer Geräte bei einer Recycling-Stelle nehmen Sie bitte Kontakt zum zuständigen städtischen Büro, Entsorgungsamt oder zu Ihrem Haushaltsabfallentsorger auf.

18. Installieren Sie das Gerät nicht in einer beengten Umgebung, zum Beispiel Bücherregal oder ähnliches.

19. Stellen Sie keine Gegenstände mit offenen Flammen, etwa brennende Kerzen, auf das Gerät.

20. Beachten Sie bei der Entsorgung von Batterien den Umweltschutz-Aspekt. Batterien müssen bei einer Batterie-Sammelstelle entsorgt werden.

21. Verwenden Sie das Gerät in tropischen und/oder gemäßigten Klimazonen.

HAFTUNGS-AUSSCHLUSS

Music Tribe übernimmt keine Haftung für Verluste, die Personen entstanden sind, die sich ganz oder teilweise auf hier enthaltene Beschreibungen, Fotos oder Aussagen verlassen haben. Technische Daten, Erscheinungsbild und andere Informationen können ohne vorherige Ankündigung geändert werden. Alle Warenzeichen sind Eigentum der jeweiligen Inhaber. Midas, Klark Teknik, Lab Gruppen, Lake, Tannoy, Turbosound, TC Electronic, TC Helicon, Behringer, Bugera und Coolaudio sind Warenzeichen oder eingetragene Warenzeichen der Music Tribe Global Brands Ltd. © Music Tribe Global Brands Ltd. 2019 Alle Rechte vorbehalten.

BESCHRÄNKTE GARANTIE

Die geltenden Garantiebedingungen und zusätzliche Informationen bezüglich der von Music Tribe gewährten beschränkten Garantie finden Sie online unter musictribe.com/warranty.

PT Instruções de Segurança Importantes



Aviso!

Terminais marcados com o símbolo carregam corrente elétrica de magnitude suficiente para constituir um risco de choque elétrico. Use apenas cabos de alto-falantes de alta qualidade com plugues TS de ¼" ou plugues com trava de torção pré-instalados. Todas as outras instalações e modificações devem ser efetuadas por pessoas qualificadas.



Este símbolo, onde quer que o encontre, alerta-o para a leitura das instruções de manuseamento que acompanham o equipamento. Por favor leia o manual de instruções.



Atenção

De forma a diminuir o risco de choque elétrico, não remover a cobertura (ou a secção de trás). Não existem peças substituíveis por parte do utilizador no seu interior. Para esse efeito recorrer a um técnico qualificado.



Atenção

Para reduzir o risco de incêndios ou choques elétricos o aparelho não deve ser exposto à chuva nem à humidade. Além disso, não deve ser sujeito a salpicos, nem devem ser colocados em cima do aparelho objectos contendo líquidos, tais como jarras.



Atenção

Estas instruções de operação devem ser utilizadas, em exclusivo, por técnicos de assistência qualificadas. Para evitar choques elétricos não proceda a reparações ou intervenções, que não as indicadas nas instruções de operação, salvo se possuir as qualificações necessárias. Para evitar choques elétricos não proceda a reparações ou intervenções, que não as indicadas nas instruções de operação. Só o deverá fazer se possuir as qualificações necessárias.

1. Leia estas instruções.

2. Guarde estas instruções.

3. Preste atenção a todos os avisos.

4. Siga todas as instruções.

5. Não utilize este dispositivo perto de água.

6. Limpe apenas com um pano seco.

7. Não obstrua as entradas de ventilação. Instale de acordo com as instruções do fabricante.

8. Não instale perto de quaisquer fontes de calor tais como radiadores, bocas de ar quente, fogões de sala ou outros aparelhos (incluindo amplificadores) que produzam calor.

9. Não anule o objectivo de segurança das fichas polarizadas ou do tipo de ligação à terra. Uma ficha polarizada dispõe de duas palhetas sendo uma mais larga do que a outra. Uma ficha do tipo ligação à terra dispõe

de duas palhetas e um terceiro dente de ligação à terra. A palheta larga ou o terceiro dente são fornecidos para sua segurança. Se a ficha fornecida não encaixar na sua tomada, consulte um electricista para a substituição da tomada obsoleta.

10. Proteja o cabo de alimentação de pisadelas ou apertos, especialmente nas fichas, extensões, e no local de saída da unidade. Certifique-se de que o cabo eléctrico está protegido. Verifique particularmente nas fichas, nos receptáculos e no ponto em que o cabo sai do aparelho.

11. O aparelho tem de estar sempre conectado à rede eléctrica com o condutor de protecção intacto.

12. Se utilizar uma ficha de rede principal ou uma tomada de aparelhos para desligar a unidade de funcionamento, esta deve estar sempre acessível.

13. Utilize apenas ligações/acessórios especificados pelo fabricante.



14. Utilize apenas com o carrinho, estrutura, tripé, suporte, ou mesa especificados pelo fabricante ou vendidos com o dispositivo. Quando utilizar um carrinho, tenha cuidado ao

mover o conjunto carrinho/dispositivo para evitar danos provocados pela terpidação.

15. Desligue este dispositivo durante as trovoadas ou quando não for utilizado durante longos períodos de tempo.

16. Qualquer tipo de reparação deve ser sempre efectuado por pessoal qualificado. É necessária uma reparação sempre que a unidade tiver sido de alguma forma danificada, como por exemplo: no caso do cabo de alimentação ou ficha se encontrarem danificados; na eventualidade de líquido ter sido derramado ou objectos terem caído para dentro do dispositivo; no caso da unidade ter estado exposta à chuva ou à humidade; se esta não funcionar normalmente, ou se tiver caído.



17. Correcta eliminação deste produto: este símbolo indica que o produto não deve ser eliminado juntamente com os resíduos domésticos, segundo a Directiva REEE (2012/19/EU) e a legislação nacional. Este produto deverá

ser levado para um centro de recolha licenciado para a reciclagem de resíduos de equipamentos eléctricos e electrónicos (EEE). O tratamento incorrecto deste tipo de resíduos pode ter um eventual impacto negativo no ambiente e na saúde humana devido a substâncias potencialmente perigosas que estão geralmente associadas aos EEE. Ao mesmo tempo, a sua colaboração para a eliminação correcta deste produto irá contribuir para a utilização eficiente dos recursos naturais. Para mais informação acerca dos locais onde poderá deixar o seu equipamento usado para reciclagem, é favor contactar os serviços municipais locais, a entidade de gestão de resíduos ou os serviços de recolha de resíduos domésticos.

18. Não instale em lugares confinados, tais como estantes ou unidades similares.

19. Não coloque fontes de chama, tais como velas acesas, sobre o aparelho.

20. Favor, obedecer os aspectos ambientais de descarte de bateria. Baterias devem ser descartadas em um ponto de coletas de baterias.

21. Use este aparelho em climas tropicais e/ou moderados.

LEGAL RENUNCIANTE

O Music Tribe não se responsabiliza por perda alguma que possa ser sofrida por qualquer pessoa que dependa, seja de maneira completa ou parcial, de qualquer descrição, fotografia, ou declaração aqui contidas. Dados técnicos, aparências e outras informações estão sujeitas a modificações sem aviso prévio. Todas as marcas são propriedade de seus respectivos donos. Midas, Klark Teknik, Lab Gruppen, Lake, Tannoy, Turbosound, TC Electronic, TC Helicon, Behringer, Bugera e Coolaudio são marcas ou marcas registradas do Music Tribe Global Brands Ltd. © Music Tribe Global Brands Ltd. 2019 Todos direitos reservados.

GARANTIA LIMITADA

Para obter os termos de garantia aplicáveis e condições e informações adicionais a respeito da garantia limitada do Music Tribe, favor verificar detalhes na íntegra através do website musictribe.com/warranty.

Thank you for choosing a TURBOSOUND loudspeaker product for your application. If you would like further information about this or any other TURBOSOUND product, please visit our website at turbosound.com.

Unpacking the Loudspeaker

After unpacking the unit please check carefully for damage. If damage is found, please notify your supplier at once. You, the consignee, must instigate any claim. Please retain all packaging in case of future re-shipment.

Controls

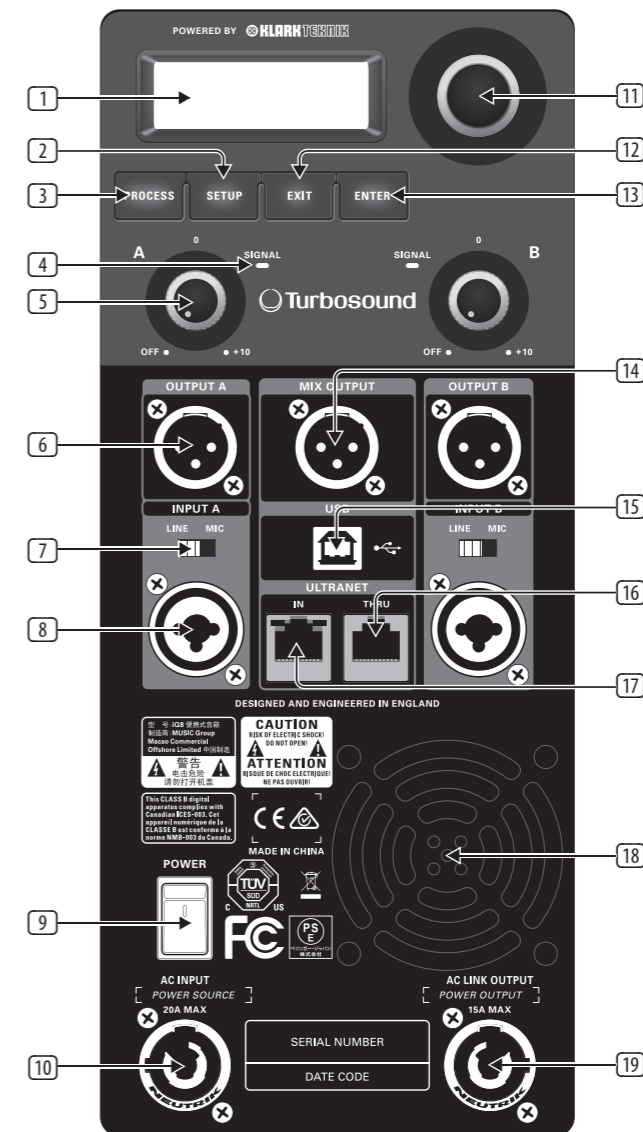

- 1 **LCD SCREEN** displays the current DSP module and parameter settings.
- 2 **SETUP** button steps through parameters within DSP processing modules.
- 3 **PROCESS** button steps through the DSP processing modules.
- 4 **SIGNAL LED** lights up to indicate the channel is receiving a signal.
- 5 **GAIN** controls adjusts the analogue input level. To increase signal gain, rotate the controls clockwise; to reduce the gain, rotate the knobs counter-clockwise. (Fullrange models have separate GAIN knobs for channels A and B, while iQ15B and iQ18B subwoofers have a single dedicated A/B knob for both channels.)
- 6 **OUTPUT A/OUTPUT B** XLR connectors provide un-processed copies of the INPUT A or INPUT B signals.
- 7 **LINE/MIC** switch adjusts the input sensitivity for INPUT A and INPUT B.
- 8 **INPUT A/INPUT B** combo jacks accept input signals using XLR, balanced 1/4" TRS or unbalanced 1/4" TS connectors.
- 9 **POWER** switch turns the unit on and off.
- 10 **AC INPUT** accepts power connections from power cables fitted with Neutrik powerCON twist-locking connectors.
- 11 **ENCODER KNOB** toggles between Graphic and Edit modes (when pressed) and changes parameter values (when rotated).
- 12 **EXIT** button returns to the top-level DSP screen when pressed.
- 13 **ENTER** button saves changes and deactivates Edit mode when pressed.
- 14 **MIX OUTPUT** XLR jack (unavailable on iQ15B and iQ18B subwoofers) sends out a post-GAIN signal composed of the summed INPUT A and INPUT B signals.
- 15 **USB** connection enables firmware updates and remote control over parameters via computer. Please visit turbosound.com to download DSP control software for your computer.
- 16 **ULTRANET THRU** sends out unprocessed digital audio from the ULTRANET IN connector to additional ULTRANET-equipped devices.
- 17 **ULTRANET IN** RJ45 plug comes with 2 linked green status LEDs. Whenever a CAT5 cable has been connected, and a valid ULTRANET signal is detected, both LEDs will light up simultaneously to indicate that the ULTRANET signal is ready to use.
- 18 **VENTILATION FAN** speed adjusts automatically to ensure trouble-free operation.
- 19 **AC LINK OUTPUT** connects power to other devices using power cables with Neutrik powerCON twist-locking connectors.

Networking capability

All iQ powered loudspeakers offer remote control via USB. The USB connection allows the user to configure and monitor all DSP parameters using dedicated iQ software for PC.

The DSP firmware can also be updated via the USB connection. Visit turbosound.com for the latest firmware version.

iQ speakers also offer proprietary ULTRANET networking capabilities through the ULTRANET IN and THRU connections using CAT5 cables with RJ45 connectors. ULTRANET allows the user to transmit unidirectionally up to 16 independent channels of 24-bit audio throughout the iQ system, as well as other ULTRANET-equipped devices such as digital mixers and personal monitor systems. Up to 7 devices can be connected in series on a single ULTRANET cable. ULTRANET can also be used for remote control of the iQ selection of modeled speakers.

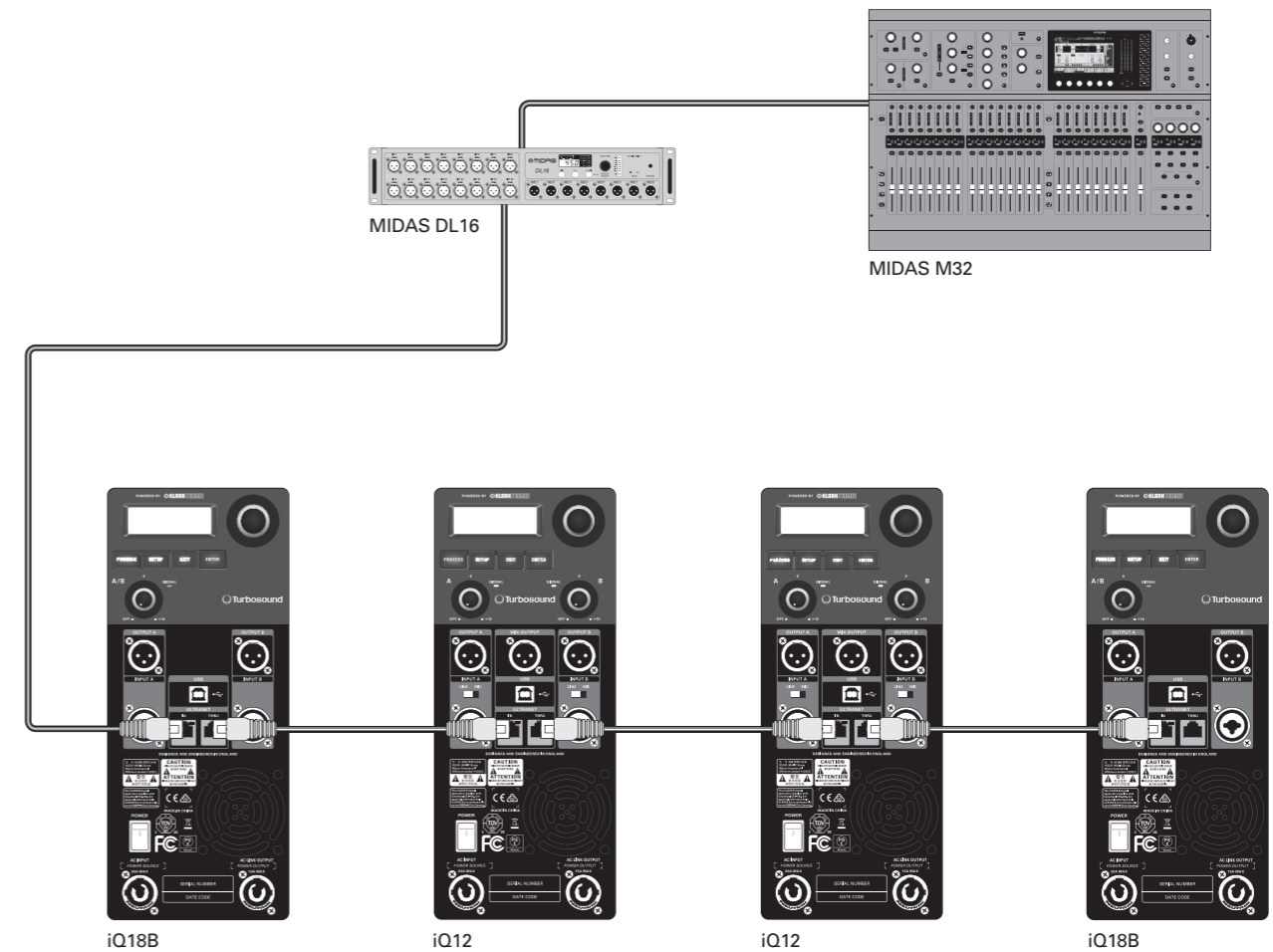

ULTRANET connection with MIDAS M32 digital mixer and MIDAS DL16 digital snake

Networked mains power



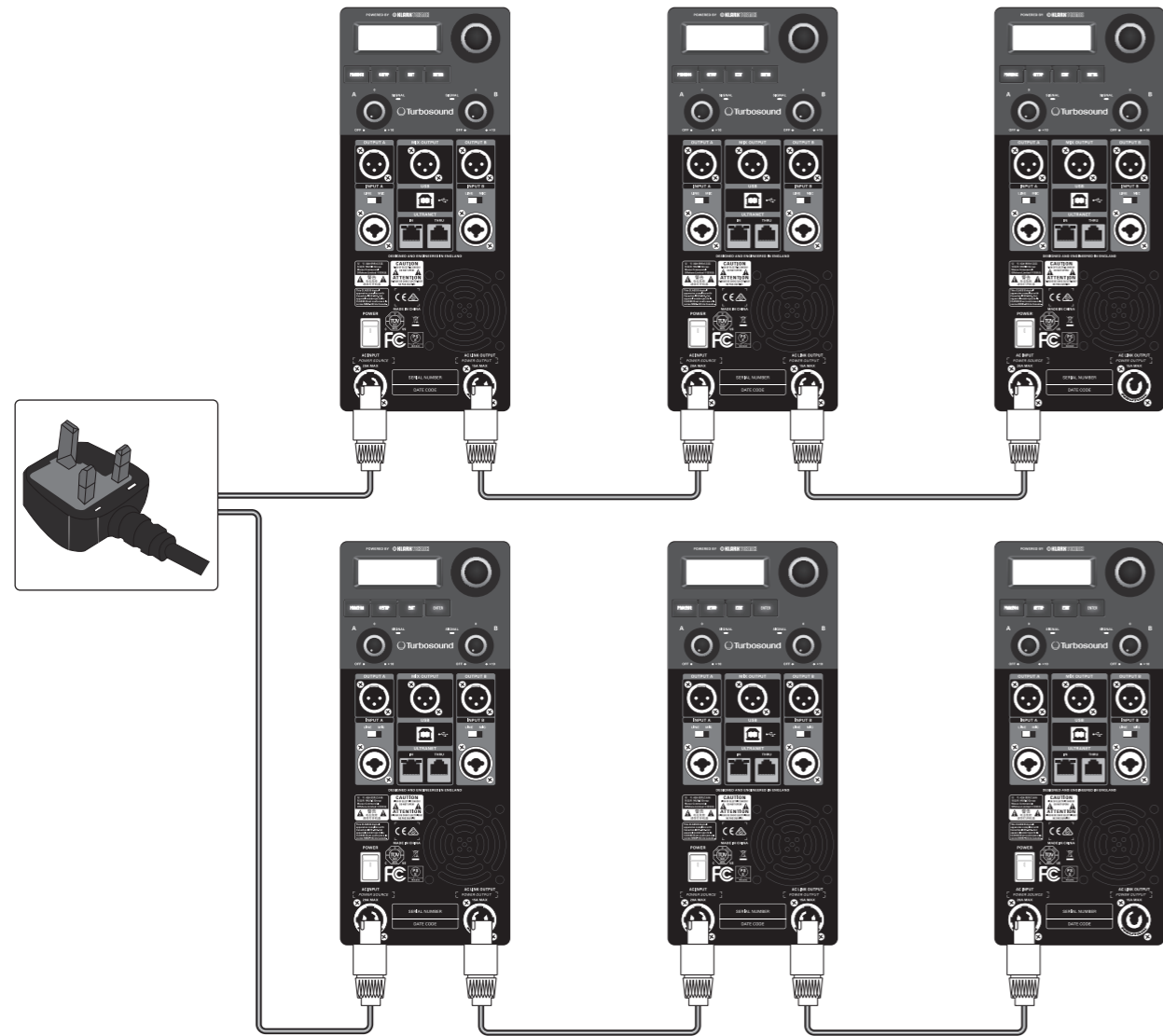



iQ loudspeakers also facilitate networked transmission of mains power using power cables with Neutrik powerCON locking power connectors. To set up networked mains power between iQ loudspeakers, first run a power cable terminating in a powerCON connector to the AC INPUT connector on the rear panel. To power additional speakers downline, run power cables equipped with powerCON connectors at both ends from the first speaker's AC LINK OUTPUT to the AC INPUT of the next iQ loudspeaker in series. The maximum number of linked systems depends on the AC supply voltage as well as the maximum current draw of the individual systems in the power chain. When linking a power chain, make sure that the integrated connectors as well as the supplied AC mains cable are never overloaded. If you are uncertain how to calculate the total current draw, please contact your dealer.







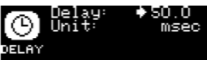

iQ speakers powered in series

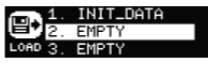
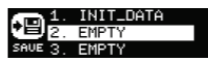
iQ DSP Menu Structure

		Fullrange	Subwoofer	Function
	MODEL	Model "xyz"	Model "xyz"	Choose from different sound Models, either the TURBOSOUND signature voicing or a DSP model of an industry standard product.
	PROCESS			
	EQ	None	None	Sets the frequency response to the default setting.
	EQ	None	None	Sets the frequency response to the default setting.
	EQ	Live	Live	Sets the frequency response to a typical live sound setting.
	EQ	Speech	Speech	Sets the frequency response for optimal speech intelligibility.
	EQ	Playback	Playback	Sets the frequency response ideal for music playback.
	EQ	User	User	Lets you define your own frequency response setting by entering the corresponding sub menu.
	EQ	Low/ High Shelving	Low/ High Shelving	Lets you define a low and high shelving filter.
	EQ	Parametric 1 & 2	Parametric 1 & 2	Lets you define a parametric bell-type EQ (Frequency, Qual and Gain).
	XOVER	None	None	Unit is set for default full range/ subwoofer reproduction.
		—	iQ8	Preset with ideal settings for use in combination with iQ8 fullrange speaker.
		—	iQ10	Preset with ideal settings for use in combination with iQ10 fullrange speaker.
		—	iQ12	Preset with ideal settings for use in combination with iQ12 fullrange speaker.
		—	iQ15	Preset with ideal settings for use in combination with iQ15 fullrange speaker.
		iQ15B	—	Preset with high pass alignment for iQ15B subwoofer.
		iQ18B	—	Preset with high pass alignment for iQ18B subwoofer.
		User	User	User crossover sub menu for combination with other fullrange or subwoofer speaker systems.
	XOVER	Freq	Freq	Select the desired crossover frequency: For Fullrange Systems: 75 Hz to 400 Hz For Subwoofer Systems: 50 Hz to 150 Hz
	XOVER	Phase	Phase	Adjust the absolute phase (0° or 180°)

		Fullrange	Subwoofer	Function
	FBQ	Auto	Auto	Automatically sets as many filters as required. Whenever a new feedback frequency is discovered, the first filter will be released to attenuate the new frequency, and so forth.
		Single	Single	Activates the FBQ (feedback detection) functionality, up to 8 feedback filters.
		Learn	Learn	Automatic procedure which searches for feedback frequencies and locks settings after all 8 filters have been set. WARNING! Please use ear protection during this procedure. The feedback signal may approach the system's maximum level, which may cause hearing damage!
		Reset	Reset	Resets all filters.
	SETUP (page 1)	Input	Input	Lets you choose the audio input source. Choose between 'Analogue', 'Ultranet' (e.g., P16 monitoring system or M32 audio via ULTRANET) and 'Auto' (automatically switches to Analogue, when no ULTRANET is connected). The page also shows the hardware (e.g., HW: A or B) and the firmware version (e.g., FW: V2.2).
	Channel	Channel	Channel	Select the ULTRANET P16 digital input channel.
	Trim	Trim	Trim	Adjusts the input gain of the ULTRANET digital inputs in a range fm +10 dB to - 30 dB
		Remote	Remote	Enables ULTRANET remote control functionality in order to protect against misuse.
		VU	VU	Displays the respective input level of all 16 channels receiving via ULTRANET; only visible when ULTRANET input is selected.
	POSITION	Stand	Floor	For positioning the speaker on a pole mount stand (fullrange) or on the floor (subwoofer).
		Wall	Wall	For positioning the speaker on or next to a wall (fixed install); alternatively as a monitor speaker (wedge).
		Ceiling	—	For positioning the speaker on a wall next to the ceiling (fixed install).
		Corner	Corner	For positioning the speaker in a corner next to the ceiling (fixed install); For positioning the speaker in a corner (subwoofer).
	DELAY	Delay	Delay	Adjusts the amount of delay (max 300msec = 103.08m or 338.19 feet).
		Unit	Unit	Selects between msec, meter and feet.
	LIMITER	Limit	Limit	Adjust the limiter threshold for the input signal (from OFF up to -30 dB). This threshold adjustment allows you to set a max output power which is below the iQ system's rated max output.

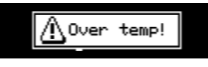
		Fullrange	Subwoofer	Function
	LOAD	1. - 20.	1. - 20.	To load a specific preset, turn the encoder to select the desired preset's number, and then either the ENTER button or the encoder. When asked to confirm press the encoder again or EXIT to abort.
	SAVE	1. - 20.	1. - 20.	To save a preset choose the respective preset slot and press ENTER or the encoder.
	Sub Menu	Save Preset	Save Preset	Name the preset by choosing the characters with the encoder and pressing to confirm each character. When finished, press the ENTER button to save the preset.
	Setup	Contrast	Contrast	Adjust LCD panel contrast. The default contrast value is 15.
	Screen	Screen	Screen	ON: LCD screen saver (default) turns on automatically after approx. 2 minutes. OFF: LCD turns off automatically after approx. 5 minutes.
	Screen	Screen	Screen	Screen saver indicates, when an ULTRANET channel is selected as the active input.
		Logo	Logo	OFF: Deactivates front panel logo illumination. ON: Activates front panel logo illumination. LIMIT: Logo will light up when the limiter is active.
	Sub Menu	Lock	Lock	Lock the device and create a password by choosing the password characters with the encoder and pressing to confirm each character. When finished press the ENTER button. Unlock the device by entering the password or connecting the unit via USB to a PC running iQ software. The software does not require a password.
	Warning	Warning	Warning	In case of overheating, an alert appears on the LCD screen, and the amplifier will shut down until the unit cools.

LCD Graphic Indicators

To help the user immediately recognize that a parameter has been selected and changed from the initial default setting, the parameter's related text on the top-level screen will invert and change to black text on a white background. As an example, the following screenshots show how the text for the MODEL function changes when the iQ8 default sound has been changed to the modeled PS8 sound:



This indicator function occurs only on the main DSP menu level and works for all DSP-related functions, except for the LOAD, SAVE and SETUP sub-sections on the second page of the top-level SETUP menu.

Mounting and fixing

iQ series powered loudspeakers are designed with multiple internal rigging points to suit many possible mounting methods in permanent installations. All cabinets can be simply suspended using optional M10 eyebolts coupled to the internal rigging points provided on the top, bottom, sides and back. The simplest method is to use the two rigging points on the top and a single pull-back rigging point in the centre of the rear panel. Remove the appropriate plastic caps and insert eyebolts, which must have a thread length of at least 30 mm. Use the rear rigging point to angle the cabinet for optimum room coverage.

Wall and Ceiling Brackets

TURBOSOUND iQ8-WB, iQ10-WB, iQ12-WB and iQ15-WB wall and ceiling brackets are optionally available for iQ series.

The graphic below shows the assembly of the optional mounting brackets (iQ8-WB, iQ10-WB, iQ12-WB and iQ15-WB).

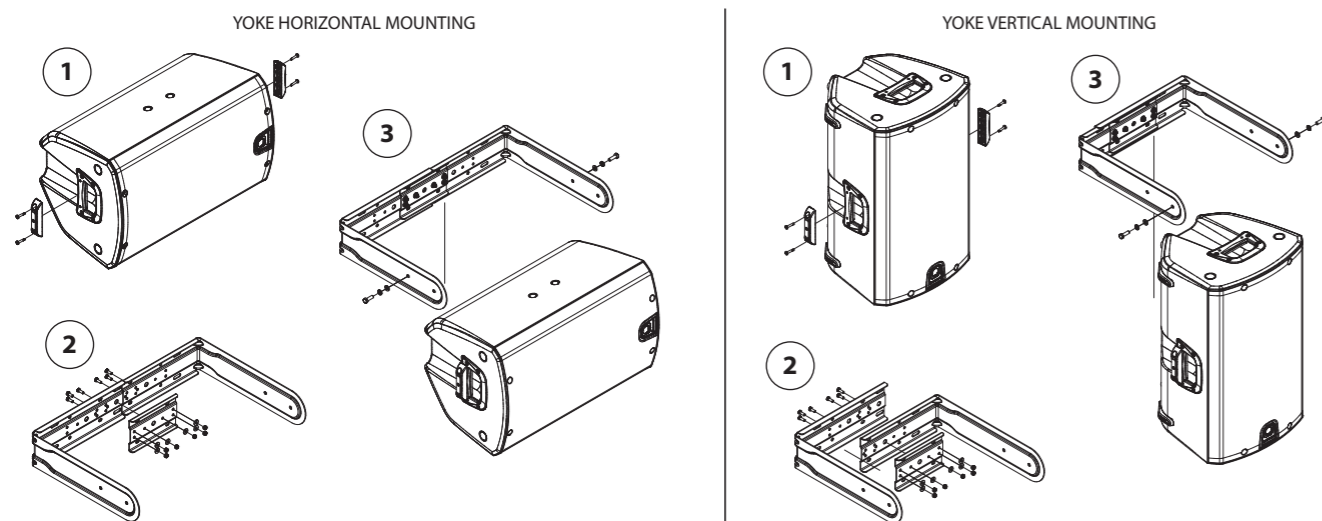

Step 1: Secure Yoke Spacers

ITEM	DESCRIPTION	QUANTITY
1	Yoke spacer	2
2	M5 x 25 mm screw with nylon thread locking	4

Step 2: Assemble Steel Yoke Bracket: iQ12 and iQ15

ITEM	DESCRIPTION	QUANTITY
1	Steel yoke bracket 1	1
2	Steel yoke bracket 2	1
3	Steel yoke bracket 3	1
4	M6 plain washer	6
5	M6 x 16 mm screw	6
6	M6 nylon locking nut	6

Step 2: Assemble Steel Yoke Bracket: iQ8 and iQ10

ITEM	DESCRIPTION	QUANTITY
1	Steel yoke bracket 1	1
2	Steel yoke bracket 2	1
3	M5 x 15 mm screw	2(iQ8) 4(iQ10)
4	M5 plain washer	2(iQ8) 4(iQ10)
5	M5 nylon locking nut	2(iQ8) 4(iQ10)

Step 3: Place Speaker Into Yoke Bracket

ITEM	DESCRIPTION	QUANTITY
1	Steel yoke bracket assembly	1
2	M8 x 25 mm screw	2
3	M8 plain washer	2
4	M8 spring lock washer	2

NOTE: For iQ8 and iQ10, the finished bracket requires only 2 pieces, while the iQ12 and iQ15 bracket requires 3 pieces.

Pole Mounting

Fullrange iQ loudspeaker models (iQ8, iQ10, iQ12 and iQ15) may also be pole mounted, either independently or in conjunction with iQ subwoofer models (iQ15B, iQ18B). The iQ pole mount sockets allow fullrange models to be mounted straight or angled 7.5° downwards for optimum coverage.

iQ10, iQ12 and iQ15 models may also be placed on one side and deployed as wedge monitors. These models have been designed with sides angled at 48° to help with upward sound dispersion.

Transport

The subwoofers are supplied with castors for ease of transportation when used as a portable sound system. To assemble the castors to the back of the cabinets, remove the 16 bolts from the rear of the speaker, align the castors with the mount holes and replace the bolts.

IMPORTANT NOTE: The mounting of a permanently installed sound system may be dangerous unless undertaken by qualified personnel with the required experience and certification to perform the necessary tasks. Walls, floors or ceilings must be capable of safely and securely supporting the actual load. The mounting accessory used must be safely and securely fixed both to the loudspeaker and to the wall, floor or ceiling.

When mounting rigging components on walls, floors or ceilings, ensure that all fixings and fasteners used are of an appropriate size and load rating. Wall and ceiling claddings, and the construction and composition of walls and ceilings, all need to be taken into account when determining whether a particular fixing arrangement can be safely employed for a particular load. Cavity plugs or other specialist fixings, if required, must be of an appropriate type, and must be fitted and used in accordance with the maker's instructions.

The operation of your speaker cabinet as part of a flown system, if installed incorrectly and improperly, can potentially expose persons to serious health risks and even death. In addition, please ensure that electrical, mechanical and acoustic considerations are discussed with qualified and certified (by local state or national authorities) personnel prior to any installation or flying.

Make sure that speaker cabinets are set up and flown by qualified and certified personnel only, using dedicated equipment and original parts and components delivered with the unit. If any parts or components are missing please contact your Dealer before attempting to set up the system.

Be sure to observe the local, state and other safety regulations applicable in your country. MUSIC Group, including the MUSIC Group companies listed on the enclosed "Service Information Sheet", assumes no liability for any damage or personal injury resulting from improper use, installation or operation of the product. Regular checks must be conducted by qualified personnel to ensure that the system remains in a secure and stable condition. Make sure that, where the speaker is flown, the area underneath the speaker is free of human traffic. Do not fly the speaker in areas that can be entered or used by members of the public.

Speakers create a magnetic field, even if not in operation. Therefore, please keep all materials that can be affected by such fields (discs, computers, monitors, etc) at a safe distance. A safe distance is usually between 1 and 2 metres.

Technical Specifications

	iQ8	iQ10	iQ12
System			
Frequency response	60 Hz – 18 kHz ±3 dB 55 Hz – 20 kHz -10 dB	55 Hz – 18 kHz ±3 dB 50 Hz – 20 kHz -10 dB	52 Hz – 18 kHz ±3 dB 45 Hz – 20 kHz -10 dB
Nominal dispersion	90° H x 90° V @ -6 dB points	90° H x 60° V @ -6 dB points	80° H x 60° V @ -6 dB points
Maximum SPL	128 dB peak	129 dB peak	130 dB peak
Crossover type	Active	Active	Active
Transducers	1 x 8" (208 mm) LF driver 1 x 1" (25.4 mm) HF compression driver	1 x 10" (256 mm) LF driver 1 x 1" (25.4 mm) HF compression driver	1 x 12" (308.5 mm) LF driver 1 x 1" (25.4 mm) HF compression driver
Limiter	Independent HF, LF, peak and rms	Independent HF, LF, peak and rms	Independent HF, LF, peak and rms
Amplifier			
Maximum output power*	2,500 W	2,500 W	2,500 W
Type	Class-D	Class-D	Class-D
Protection	Short circuit, open circuit, thermal	Short circuit, open circuit, thermal	Short circuit, open circuit, thermal
Connectors			
Input A / B	2 x combo jack/XLR	2 x combo jack/XLR	2 x combo jack/XLR
Sensitivity	Line +4 dBu, mic -22 dBu, switchable	Line +4 dBu, mic -22 dBu, switchable	Line +4 dBu, mic -22 dBu, switchable
Input impedance	20 kΩ unbalanced, 40 kΩ balanced	20 kΩ unbalanced, 40 kΩ balanced	20 kΩ unbalanced, 40 kΩ balanced
Maximum input level	+21 dBu	+21 dBu	+21 dBu
Output A / B	2 x XLR Linked to input	2 x XLR Linked to input	2 x XLR Linked to input
Mix output	XLR, balanced	XLR, balanced	XLR, balanced
Output impedance	100 Ω unbalanced, 200 Ω balanced	100 Ω unbalanced, 200 Ω balanced	100 Ω unbalanced, 200 Ω balanced
Ultranet input/link	2 x RJ45	2 x RJ45	2 x RJ45
Mains Supply	Neutrik powerCON input 20A and link 15A	Neutrik powerCON input 20A and link 15A	Neutrik powerCON input 20A and link 15A
Controls			
DSP	Rotary push-encoder Buttons for PROCESS, SETUP, EXIT, ENTER	Rotary push-encoder Buttons for PROCESS, SETUP, EXIT, ENTER	Rotary push-encoder Buttons for PROCESS, SETUP, EXIT, ENTER
Mixer section	2 x gain controls (channels A and B) 2 x Line/Mic switch	2 x gain controls (channels A and B) 2 x Line/Mic switch	2 x gain controls (channels A and B) 2 x Line/Mic switch
User DSP Functions			
Factory EQ presets	Positioning, Sound mode, Sound Modeling, FBQ	Positioning, Sound mode, Sound Modeling, FBQ	Positioning, Sound mode, Sound Modeling, FBQ
Display	LCD 128 x 32, blue backlit	LCD 128 x 32, blue backlit	LCD 128 x 32, blue backlit
Delay	0 - 300 ms	0 - 300 ms	0 - 300 ms
Equalisation	High and low shelving EQ 2 x parametric EQ	High and low shelving EQ 2 x parametric EQ	High and low shelving EQ 2 x parametric EQ
Limiter	Zero attack input limiter	Zero attack input limiter	Zero attack input limiter
Presets	20 total presets, 19 user-definable	20 total presets, 19 user-definable	20 total presets, 19 user-definable
Crossover	High Pass L-R 24 dB/oct	High Pass L-R 24 dB/oct	High Pass L-R 24 dB/oct
Protection	Lock-out function for all settings	Lock-out function for all settings	Lock-out function for all settings

	iQ8	iQ10	iQ12
Ultranet Digital Network			
System			
Signal Latency	16 channels < 0.9 ms	16 channels < 0.9 ms	16 channels < 0.9 ms
Cabling			
Cables	Shielded CAT5	Shielded CAT5	Shielded CAT5
Cable length	max. 246 ft / 75 m recommended	max. 246 ft / 75 m recommended	max. 246 ft / 75 m recommended
Power Supply			
Power consumption	150 W @ ¼ max power	150 W @ ¼ max power	150 W @ ¼ max power
Voltage (fuses)			
USA / Canada	120 V~, 60 Hz (T 15 A H 250 V) 220-240 V~, 50/60 Hz (T 10 A H 250 V)	120 V~, 60 Hz (T 15 A H 250 V) 220-240 V~, 50/60 Hz (T 10 A H 250 V)	120 V~, 60 Hz (T 15 A H 250 V) 220-240 V~, 50/60 Hz (T 10 A H 250 V)
UK / Australia / Europe	220-240 V~, 50/60 Hz (T 10 A H 250 V)	220-240 V~, 50/60 Hz (T 10 A H 250 V)	220-240 V~, 50/60 Hz (T 10 A H 250 V)
Korea / China	220-240 V~, 50/60 Hz (T 10 A H 250 V)	220-240 V~, 50/60 Hz (T 10 A H 250 V)	220-240 V~, 50/60 Hz (T 10 A H 250 V)
Japan	100 V~, 50/60 Hz (T 15 A H 250 V)	100 V~, 50/60 Hz (T 15 A H 250 V)	100 V~, 50/60 Hz (T 15 A H 250 V)
Enclosure			
Dimensions HWD	457 x 279 x 279 mm (18.0 x 11.0 x 11.0")	526 x 324 x 316 mm (20.7 x 12.7 x 12.4")	609 x 370 x 370 mm (24.0 x 14.5 x 14.5")
Net weight	14.7 kg (32 lbs)	17.2 kg (38 lbs)	21.1 kg (46 lbs)
Construction	Injection-moulded polypropylene enclosure	Injection-moulded polypropylene enclosure	Injection-moulded polypropylene enclosure
Finish	Black painted	Black painted	Black painted
Grille	Powder coated perforated steel	Powder coated perforated steel	Powder coated perforated steel
Flying hardware	M10 x 3 points	M10 x 3 points	M10 x 3 points
Accessories			
	iQ8-WB Steel wall bracket	iQ10-WB Steel wall bracket	iQ12-WB Steel wall bracket

Technical Specifications

	iQ15	iQ15B	iQ18B
System			
Frequency response	50 Hz – 18 kHz ±3 dB 42 Hz – 20 kHz -10 dB	50 Hz – 130 Hz ±3 dB 40 Hz – 130 Hz -10 dB	50 Hz – 100 Hz ±3 dB 36 Hz – 100 Hz -10 dB
Nominal dispersion	75° H x 55° V @ -6 dB points	Half Space	Half Space
Maximum SPL	132 dB peak	130 dB peak	132 dB peak
Crossover type	Active	Active	Active
Transducers	1 x 1" (387 mm) LF driver 1 x 1" (25.4 mm) HF compression driver	1 x 15" (385.7 mm) LF driver	1 x 18" (460 mm) LF driver
Limiter	Independent HF, LF, peak and rms	Peak and rms	Peak and rms
Amplifier			
Maximum output power*	2,500 W	3,000 W	3,000 W
Type	Class-D	Class-D	Class-D
Protection	Short circuit, open circuit, thermal	Short circuit, open circuit, thermal	Short circuit, open circuit, thermal
Connectors			
Input A / B	2 x combo jack/XLR	2 x combo jack/XLR	2 x combo jack/XLR
Sensitivity	Line +4 dBu, mic -22 dBu, switchable	Line +4 dBu	Line +4 dBu
Input impedance	20 kΩ unbalanced, 40 kΩ balanced	20 kΩ unbalanced, 40 kΩ balanced	20 kΩ unbalanced, 40 kΩ balanced
Maximum input level	+21 dBu	+21 dBu	+21 dBu
Output A / B	2 x XLR Linked to input	2 x XLR Linked to input	2 x XLR Linked to input
Mix output	XLR, balanced	N/A	N/A
Output impedance	100 Ω unbalanced, 200 Ω balanced	N/A	N/A
Ultraset input/link	2 x RJ45	2 x RJ45	2 x RJ45
Mains Supply	Neutrik powerCON input 20A and link 15A	Neutrik powerCON input 20A and link 15A	Neutrik powerCON input 20A and link 15A
Controls			
DSP	Rotary push-encoder Buttons for PROCESS, SETUP, EXIT, ENTER	Rotary push-encoder Buttons for PROCESS, SETUP, EXIT, ENTER	Rotary push-encoder Buttons for PROCESS, SETUP, EXIT, ENTER
Mixer section	2 x gain controls (channels A and B) 2 x Line/Mic switch	1 x gain controls (channels A and B) 2 x Line	1 x gain controls (channels A and B) 2 x Line
User DSP Functions			
Factory EQ presets	Positioning, Sound mode, Sound Modeling, FBQ	Positioning, Sound mode, Sound Modeling, FBQ	Positioning, Sound mode, Sound Modeling, FBQ
Display	LCD 128 x 32, blue backlit	LCD 128 x 32, blue backlit	LCD 128 x 32, blue backlit
Delay	0 - 300 ms	0 - 300 ms	0 - 300 ms
Equalisation	High and low shelving EQ 2 x parametric EQ	High and low shelving EQ 2 x parametric EQ	High and low shelving EQ 2 x parametric EQ
Limiter	Zero attack input limiter	Zero attack input limiter	Zero attack input limiter
Presets	20 total presets, 19 user-definable	20 total presets, 19 user-definable	20 total presets, 19 user-definable
Crossover	High Pass L-R 24 dB/oct	Low Pass L-R 24 dB/oct	Low Pass L-R 24 dB/oct
Protection	Lock-out function for all settings	Lock-out function for all settings	Lock-out function for all settings

	iQ15	iQ15B	iQ18B
Ultraset Digital Network			
System			
Signal Latency	16 channels < 0.9 ms	16 channels < 0.9 ms	16 channels < 0.9 ms
Cabling			
Cables	Shielded CAT5	Shielded CAT5	Shielded CAT5
Cable length	max. 246 ft / 75 m recommended	max. 246 ft / 75 m recommended	max. 246 ft / 75 m recommended
Power Supply			
Power consumption	150 W @ ¼ max power	200 W @ ¼ max power	200 W @ ¼ max power
Voltage (fuses)			
USA / Canada	120 V~, 60 Hz (T 15 A H 250 V) 220-240 V~, 50/60 Hz (T 10 A H 250 V)	120 V~, 60 Hz (T 15 A H 250 V) 220-240 V~, 50/60 Hz (T 10 A H 250 V)	120 V~, 60 Hz (T 15 A H 250 V) 220-240 V~, 50/60 Hz (T 10 A H 250 V)
UK / Australia / Europe	220-240 V~, 50/60 Hz (T 10 A H 250 V)	220-240 V~, 50/60 Hz (T 10 A H 250 V)	220-240 V~, 50/60 Hz (T 10 A H 250 V)
Korea / China	220-240 V~, 50/60 Hz (T 10 A H 250 V)	220-240 V~, 50/60 Hz (T 10 A H 250 V)	220-240 V~, 50/60 Hz (T 10 A H 250 V)
Japan	100 V~, 50/60 Hz (T 15 A H 250 V)	100 V~, 50/60 Hz (T 15 A H 250 V)	100 V~, 50/60 Hz (T 15 A H 250 V)
Enclosure			
Dimensions HWD	711 x 450 x 381 mm (27.9 x 17.7 x 15.0")	602 x 445 x 495 mm (23.7 x 17.5 x 19.5")	691 x 533 x 559 mm (27.2 x 21.0 x 22.0")
Net weight	26.1 kg (57 lbs)	30.6 kg (67 lbs)	39.8 kg (87.5 lbs)
Construction	Injection-moulded polypropylene enclosure	Birch plywood, screwed, and glued	Birch plywood, screwed, and glued
Finish	Black painted	Black painted	Black painted
Grille	Powder coated perforated steel	Powder coated perforated steel	Powder coated perforated steel
Flying hardware	M10 x 3 points	N/A	N/A
Accessories			
	IQ15-WB Steel wall bracket		

*independent of limiters and driver protection circuits

Other important information

EN Important information

1. Register online. Please register your new Music Tribe equipment right after you purchase it by visiting [turbosound.com](https://www.turbosound.com). Registering your purchase using our simple online form helps us to process your repair claims more quickly and efficiently. Also, read the terms and conditions of our warranty, if applicable.

2. Malfunction. Should your Music Tribe Authorized Reseller not be located in your vicinity, you may contact the Music Tribe Authorized Fulfiller for your country listed under "Support" at [turbosound.com](https://www.turbosound.com). Should your country not be listed, please check if your problem can be dealt with by our "Online Support" which may also be found under "Support" at [turbosound.com](https://www.turbosound.com). Alternatively, please submit an online warranty claim at [turbosound.com](https://www.turbosound.com) BEFORE returning the product.

3. Power Connections. Before plugging the unit into a power socket, please make sure you are using the correct mains voltage for your particular model. Faulty fuses must be replaced with fuses of the same type and rating without exception.

FEDERAL COMMUNICATIONS COMMISSION COMPLIANCE INFORMATION

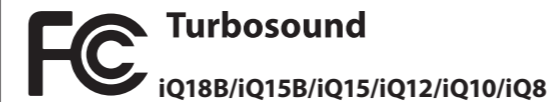

Responsible Party Name: Music Tribe Brands UK Ltd.
 Address: Klark Industrial Park,
 Walter Nash Road,
 Kidderminster, Worcestershire,
 DY11 7HJ United Kingdom
 Phone Number: +44 1562 732290

iQ18B/iQ15B/iQ15/iQ12/iQ10/iQ8

This equipment has been tested and found to comply with the limits for a Class B digital device, pursuant to part 15 of the FCC Rules. These limits are designed to provide reasonable protection against harmful interference in a residential installation. This equipment generates, uses and can radiate radio frequency energy and, if not installed and used in accordance with the instructions, may cause harmful interference to radio communications. However, there is no guarantee that interference will not occur in a particular installation. If this equipment does cause harmful interference to radio or television reception, which can be determined by turning the equipment off and on, the user is encouraged to try to correct the interference by one or more of the following measures:

- Reorient or relocate the receiving antenna.
- Increase the separation between the equipment and receiver.
- Connect the equipment into an outlet on a circuit different from that to which the receiver is connected.
- Consult the dealer or an experienced radio/TV technician for help.

This equipment complies with Part 15 of the FCC Rules. Operation is subject to the following two conditions:

- (1) This device may not cause harmful interference, and
- (2) This device must accept any interference received, including interference that may cause undesired operation.

Important information:

Changes or modifications to the equipment not expressly approved by MUSIC Tribe can void the user's authority to use the equipment.

