

## Studio Monitoring

# GOLD 8

Premium 300-Watt Bi-Amplified Nearfield Studio Reference Monitor with Proprietary 8" Dual Concentric Point Source Technology

- Premium 300 Watt bi-amped nearfield studio reference monitor for accurate sound reproduction with outstanding definition
- Ultra-precise and neutral soundstage delivers non-fatiguing sound for extended listening sessions
- Legendary Tannoy Dual Concentric driver technology provides class-leading phase coherence and point-source imaging
- Front-firing bass port design allows for near-wall placement and ensures optimal low frequency performance
- Next generation 8" Dual Concentric driver secures unrivalled musical articulation and outstanding dynamics
- 1" titanium tweeter with Tulip waveguide produces detailed stereo image with widened "sweet spot"
- Class-AB system with transducer-matched LF and HF bi-amplification for accurate dynamics
- Continually-active XLR and TRS phone jack inputs let you connect up to 2 audio sources
- Dedicated input trim, bass and treble controls let you optimise the audio for your listening conditions
- Selectable automatic standby mode conserves energy
- Tannoy - over 90 years of British audio innovation
- 3-Year Warranty Program\*
- Designed and engineered in the U.K.

Whether you're recording, editing, mixing, or mastering audio, a truly great studio reference monitor design needs to provide the most accurate, uncolored representation of your music as possible. Tannoy Gold nearfield reference monitors have been created to serve the demanding needs of professionals in recording, broadcast and post-production environments. Engineered to the highest standards and build quality, The Gold 8 will impress you whether you're a seasoned Tannoy user or just taking your first step up to a monitor system based on the legendary Dual Concentric™ driver.



## Unrivalled Performance

Times may have changed, but our engineering values and commitment to perfection have not. Everything we do today is judged against our considerable achievements of the past as we continue to advance the art and science of building the world's premier reference monitors. Constant refinement of our famed Dual Concentric™ driver, advanced Klippel™ analysis and a host of other technologies ensure that with every new product comes another historic chapter. Thanks to the integrated design, the speakers and the amplifiers are designed as one. Breathtaking yesterday; equally breathtaking today...

Studio Monitoring

# GOLD 8

Premium 300-Watt Bi-Amplified Nearfield Studio Reference Monitor with Proprietary 8" Dual Concentric Point Source Technology

## Obsessive About Precision

Clearly, to build the best studio monitors you must start with the very best drivers. At Tannoy our reputation for excellence is built on the quality and performance of the speaker systems we build, and that is why we continue to design and manufacture our own drivers. Tannoy has long held to a philosophical stand on crossover points, understanding the anomalous effects of any crossover network with respect to phase. Our monitor designs have consequently always strived to minimise the number of crossover points that fall inside the critical response band. Reducing the number of crossover points reduces potential phase errors and creates a more natural and accurate device.

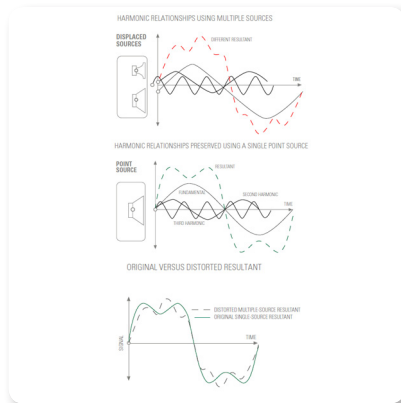

## Tannoy Dual Concentric™

At the heart of the GOLD 8's superb performance you will find an all-new iteration of our legendary and exclusive Tannoy Dual Concentric Driver Technology. With seven decades of refinement behind it, the Dual Concentric™ driver represents a near-perfect point source, preserving the tonal character and harmonic structure of program material as no discrete-driver system can. The benefits are immediately obvious with flat response, controlled dispersion and a wider sweet-spot in both the horizontal and vertical planes.

## Point Source Tulip Waveguide

In nature, all sounds emanate from a single point in space. By centrally-locating the high frequency unit of the Dual Concentric configuration, GOLD 8 acoustically replicates the single point sound source, delivering exceptionally natural performance with an incredibly wide imaging "sweet-spot". Delivery is further enhanced by the implementation of a highly-innovative point source Tulip Waveguide with symmetrical dispersion, which provides a broad soundstage with remarkably focused and accurate stereo imaging.

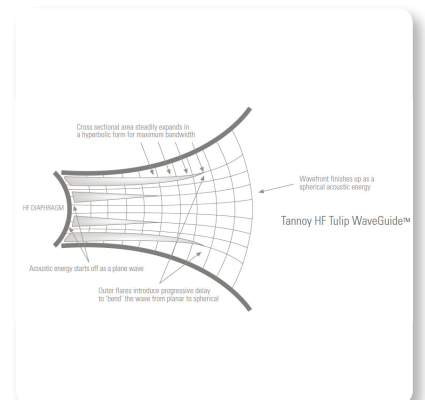

Studio Monitoring

# GOLD 8

Premium 300-Watt Bi-Amplified Nearfield Studio Reference Monitor with Proprietary 8" Dual Concentric Point Source Technology



## Suited For All Placements

The ideal environment for listening is a room that is “flat,” neither too reflective (reverberant) nor too absorptive (where the sound is muffled). But since all rooms are not the same acoustically, your GOLD 8 comes equipped to function in a wide variety of environments. HF trim control, and a rear panel filter switch is provided to adapt the monitor’s low frequency characteristics for the effects of boundary conditions.

## Bi-Amplification Via Class-AB

Why Class-AB? The duty of any amplifier is to take a small input signal and turn it into a louder output that maintains the characteristics of the original signal, and to be large enough to meet the demands of the loudspeaker it drives. While Class-A amplifiers sound great at low volumes, they waste a tremendous amount of power that is lost as heat when asked to output hundreds of Watts. And even though Class-B amplifiers are much more efficient, they tend to bring a great deal of distortion to the mix. A Class-AB amplifier combines the linear performance of Class-A with the higher efficiency performance of Class-B, producing a much better amplifier design for loudspeakers used in critical listening environments.

**CLASS-AB  
300 WATTS**



## Flexible Connectivity

GOLD 8 allows you to connect up to 2 audio sources simultaneously thanks to its continually-active XLR and TRS inputs, and assign Left or Right when connected to a 3.5mm TRS jack plug. Switchable intelligent signal sensing circuitry is included, ensuring that when your system is not in use, your monitors switch into an environmentally friendly, power-saving stand-by mode.

## Studio Monitoring

# GOLD 8

Premium 300-Watt Bi-Amplified Nearfield  
Studio Reference Monitor with Proprietary  
8" Dual Concentric Point Source Technology

### The Legacy Lives On

Many of the world's greatest hits have been recorded and mixed using Tannoy studio monitors. Tannoy's long and storied legacy lives on in the GOLD 8 Dual Concentric Studio Reference Monitor; a legacy that has endured the test of time and adapted with the evolution of technology. Greater low frequency extension, higher output and enhanced reliability are only part of the story with the Gold 8. This is a monitor that is sure to become a classic because it does everything well; from dynamic music content, to dialogue and everything in between, the Gold 8 will become your most trusted reference for every project.



### You Are Covered

We always strive to provide the best possible Customer Experience. Our products are made in our own Music Tribe factory using state-of-the-art automation, enhanced production workflows and quality assurance labs with the most sophisticated test equipment available in the world. As a result, we have one of the lowest product failure rates in the industry, and we confidently back it up with a generous Warranty program.

Studio Monitoring

# GOLD 8

Premium 300-Watt Bi-Amplified Nearfield  
Studio Reference Monitor with Proprietary  
8" Dual Concentric Point Source Technology

## Frequency Response Sensitivity 1 W / 1 m

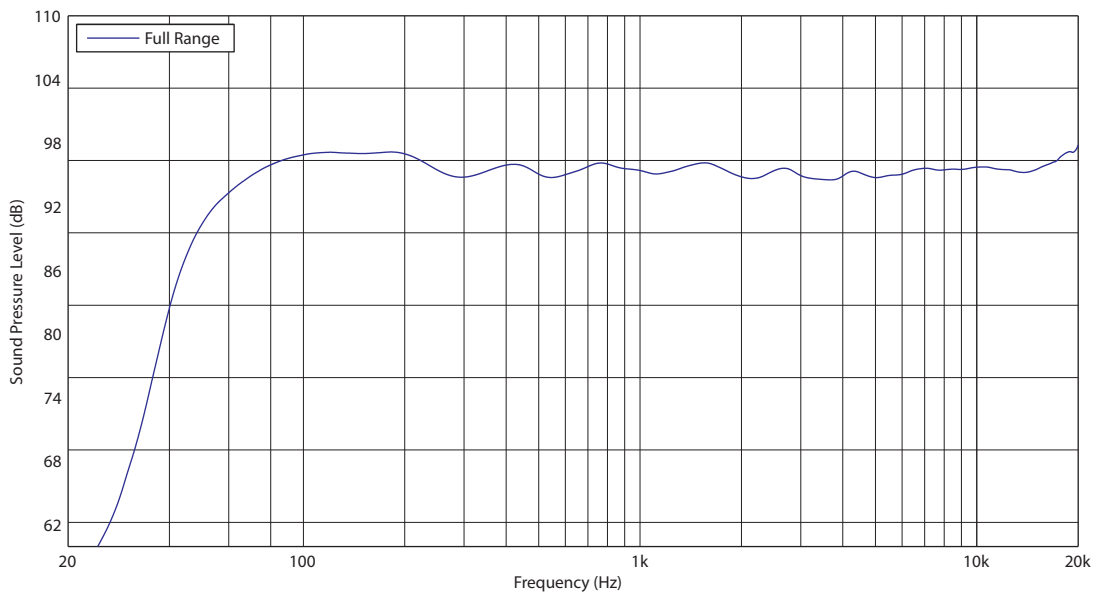

## Studio Monitoring

# GOLD 8

Premium 300-Watt Bi-Amplified Nearfield  
Studio Reference Monitor with Proprietary  
8" Dual Concentric Point Source Technology

## Horizontal Beamwidth

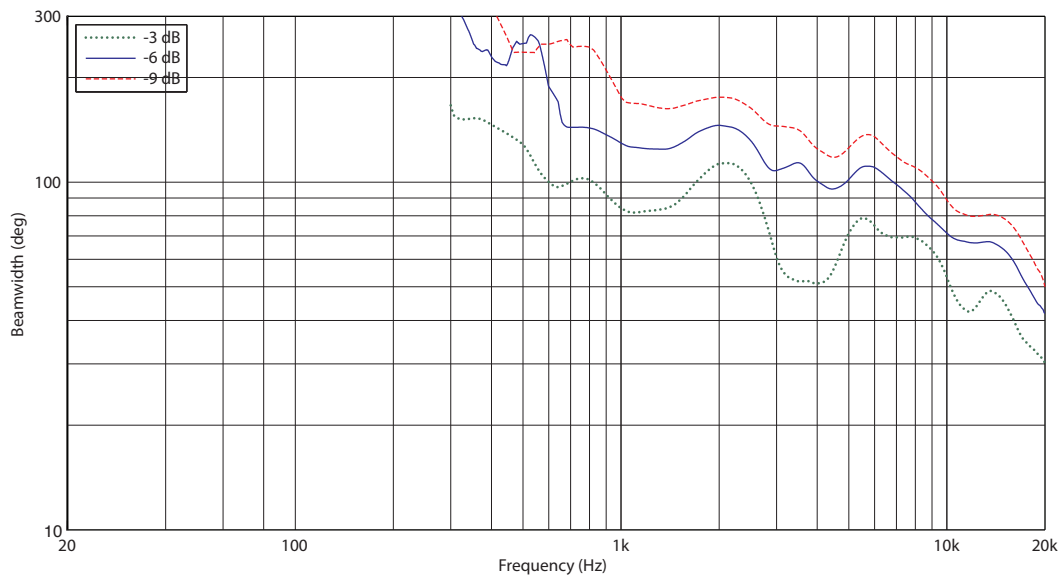

## Studio Monitoring

# GOLD 8

Premium 300-Watt Bi-Amplified Nearfield Studio Reference Monitor with Proprietary 8" Dual Concentric Point Source Technology

## Polar Plots

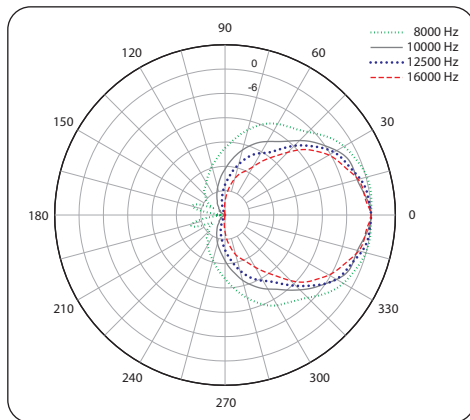
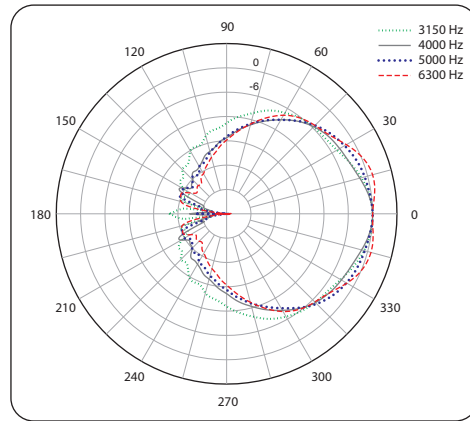
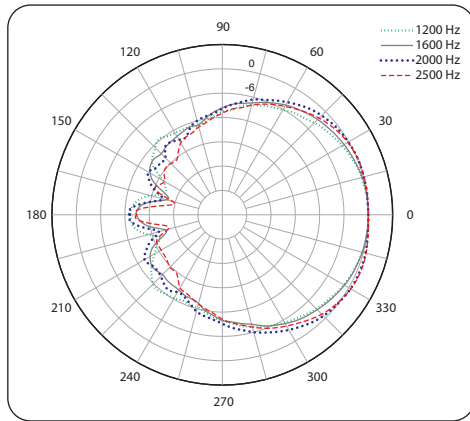
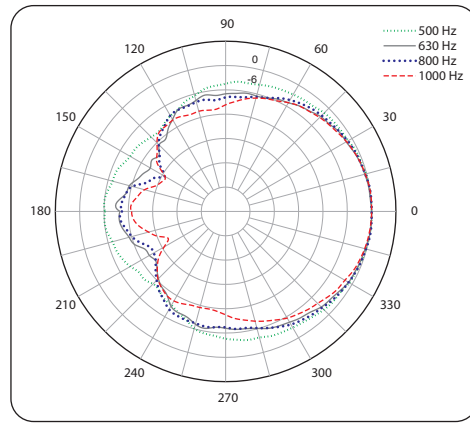
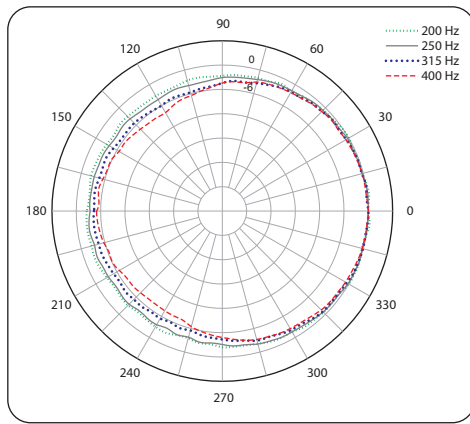

Studio Monitoring

# GOLD 8

Premium 300-Watt Bi-Amplified Nearfield Studio Reference Monitor with Proprietary 8" Dual Concentric Point Source Technology

## Dimensions

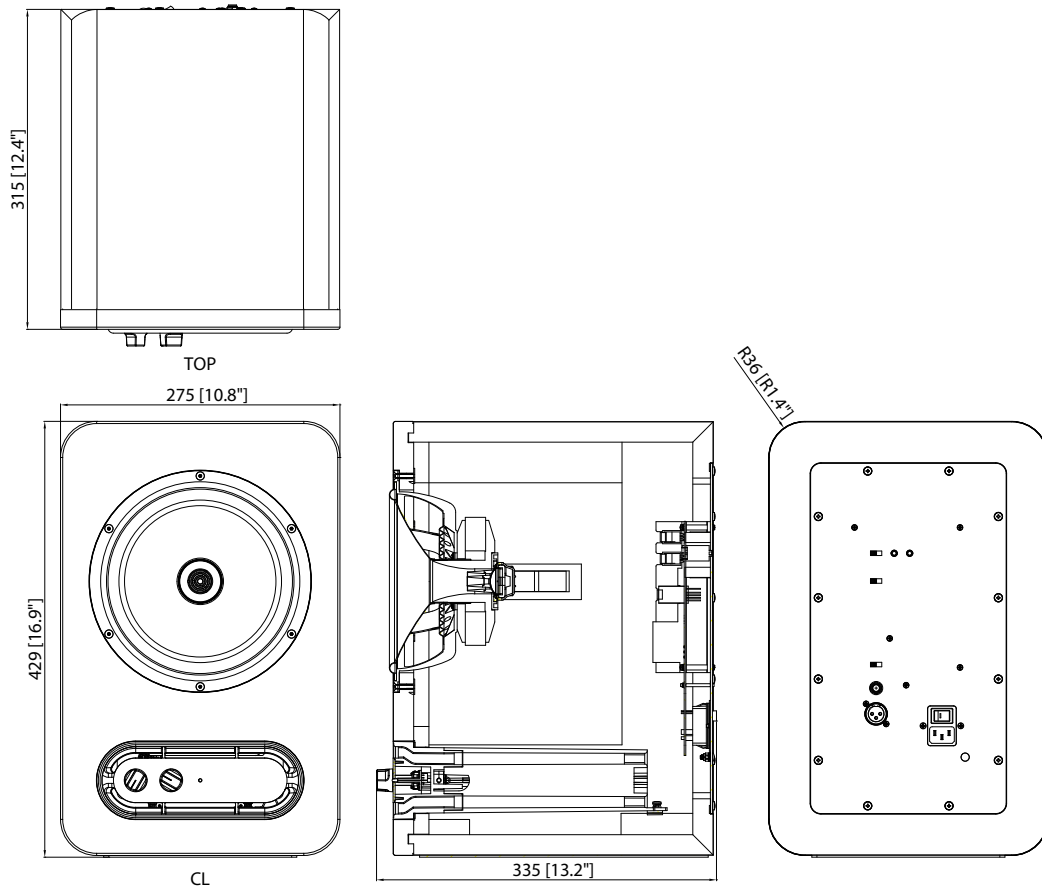



## Studio Monitoring

# GOLD 8

Premium 300-Watt Bi-Amplified Nearfield  
Studio Reference Monitor with Proprietary  
8" Dual Concentric Point Source Technology

## Technical Specifications

### System

Frequency response	54 Hz – 20 kHz $\pm$ 3 dB 40 Hz – 20 kHz -10 dB
Nominal dispersion	90° conical @ -6 dB point
Maximum SPL	110 dB
Crossover type	2 way, active
Crossover frequency	1.5 kHz
Transducers	1 x 8" (203 mm) LF driver 1 x 1" (25.4 mm) HF drivers
Limiter	Independent high and low frequency limiters
Magnetic shielding	No

### Amplifier

Maximum output power	300 W
Type	Class-AB
Protection	Short circuit, thermal

### Connectors

Inputs	1 x XLR, balanced 1 x ¼" TRS, balanced 3.5 mm stereo mini jack
Sensitivity	0 dBu, nominal
Input impedance	5 k $\Omega$ unbalanced, 10 k $\Omega$ balanced
Maximum input level	+20 dBu
Outputs	Monitor link, 3.5 mm stereo mini jack
User controls	Power on / off, Input trim, HF trim, Bass adjustment, Auto-standby on / off

### Power Supply

Power consumption	80 W @ 1/8 max power
Voltage (fuses)	100-240 V~, 50/60 Hz (T 3.15 A L 250 V)
Mains supply	IEC mains connector with integrated power switch

### Enclosure

Dimensions (H x W x D)	429 x 274 x 336 mm (16.9 x 10.8 x 13.2")
Net weight	14.0 kg (30.8 lbs)

Studio Monitoring

# GOLD 8

Premium 300-Watt Bi-Amplified Nearfield  
Studio Reference Monitor with Proprietary  
8" Dual Concentric Point Source Technology



Studio Monitoring

# GOLD 8

Premium 300-Watt Bi-Amplified Nearfield  
Studio Reference Monitor with Proprietary  
8" Dual Concentric Point Source Technology



## Studio Monitoring

# GOLD 8

Premium 300-Watt Bi-Amplified Nearfield Studio Reference Monitor with Proprietary 8" Dual Concentric Point Source Technology



For service, support or more information contact the Tannoy location nearest you:

**Europe**  
**Music Tribe Brands UK Ltd.**  
Tel: +44156 273 2290  
Email: CARECrea@musictribe.com  
CAREEnte@musictribe.com  
CARELife@musictribe.com

**USA/Canada**  
**Music Tribe Commercial NV Inc.**  
Tel: +1 702 800 8290  
Email: CARECrea@musictribe.com  
CAREEnte@musictribe.com  
CARELife@musictribe.com

**Japan**  
**Music Tribe Services JP K.K.**  
Tel: +81 3 6231 0453  
Email: CARECrea@musictribe.com  
CAREEnte@musictribe.com  
CARELife@musictribe.com

Music Tribe accepts no liability for any loss which may be suffered by any person who relies either wholly or in part upon any description, photograph, or statement contained herein. Technical specifications, appearances and other information are subject to change without notice. All trademarks are the property of their respective owners. Midas, Klark Teknik, Lab Gruppen, Lake, Tannoy, Turbosound, TC Electronic, TC Helicon, Behringer, Bugera and Coolaudio are trademarks or registered trademarks of Music Tribe Global Brands Ltd. © Music Tribe Global Brands Ltd. 2019 All rights reserved.

# TANNOY