



Product description

Designed for a wide variety of sound reinforcement applications, the Tannoy AMS 5ICT LS is a high performance, ultra-compact surface mount weather resistant loudspeaker specifically designed to UUMW standards for use in mission critical life safety applications.

The AMS 5ICT LS IS a full bandwidth loudspeaker designed for commercial, professional and residential applications where environment durability and high quality sonic performance are required. Indoor or outdoor, these speakers are ideally suited to stereo or monaural background or foreground music systems in applications as diverse as theme parks, retail premises, restaurants and cafés, corporate audio visual, residential developments and houses of worship.

Equipped with Tannoy's unique and exclusive point source ICT™ 130mm (5") drive unit, the AMS 5ICT LS delivers an acoustic performance of outstanding clarity, definition and detail. The point source configuration of the Tannoy ICT driver's mid-bass and tweeter sections ensures a wide and controlled dispersion for optimum coverage; this while avoiding the massive loss of energy in the vertical plane, at the crossover frequency, inherent in two-way discrete designs. The ICT (Inductive Coupling Technology) drive unit also addresses the two most common component failures experienced in background music and sound reinforcement systems, the tweeter and the crossover reliability. The use of a wireless electromagnetic tweeter means that no crossover is required in the design; this therefore ensures that an ICT unit is exceptionally reliable and therefore ideal for applications where constant heavy usage is the norm. This aluminium high frequency dome has a deep drawn skirt that sits on the inside of the low frequency voice coil in the same magnetic gap. The skirt is like a single shorted turn that is induced with high frequency information generated by the low frequency voice coil, which is fed a full bandwidth signal. The mineral loaded polypropylene cone material and nitrile rubber surround further enhance durability and long-term reliability.

The AMS 5ICT LS is UL-1480, category UUMW when installed with a junction box (on-wall or in-wall). For use with non-DC supervised systems.

Features

- 130 mm (5.00") ICT transducer for high performance and durability
- 90 degree controlled conical dispersion for optimum coverage and forward gain
- Weather resistant rated IP65 to EN60529 (IEC529)
- High power handling and extended bandwidth
- Phase coherent design for superior vocal articulation and music reproduction
- No crossover required, ensuring better phase, impedance and sensitivity response and increased durability
- Yoke bracket supplied, optional accessories include a fully adjustable multi-angle wall bracket

Applications

- Indoor or outdoor commercial, professional and residential installations
- Fire Alarm and/or Emergency Communication Systems
- High level stereo or monaural background or foreground music and speech paging systems
- Theme parks
- Reception / waiting rooms
- Airports, convention centres and hotels
- Business music systems
- Boardrooms and offices
- Cruise ships
- Retail outlets and shopping malls
- Restaurants and cafes
- Corporate audio visual
- Residential developments
- Houses of worship

Physical data

Dimensions (H x W x D):	248.0 x 155.0 x 203.9 mm, (9.77 x 6.10 x 8.03")
Net Weight:	3.25 kg (7.16 lbs)
Enclosure:	ABS
Finish:	Black or white

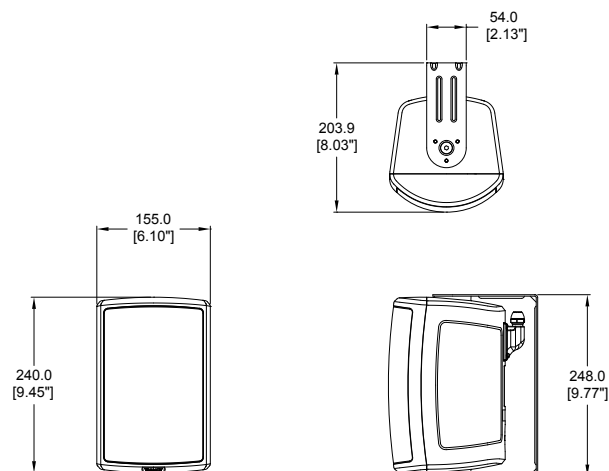

1 m on-axis Frequency Response

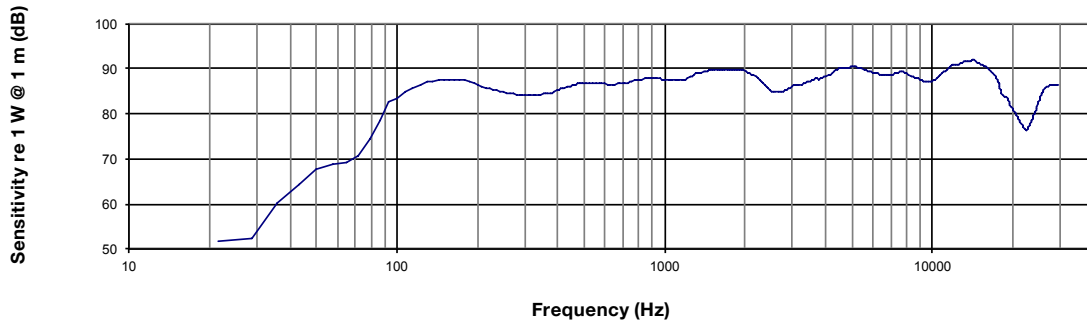

Anechoic Frequency Response

Impedance vs frequency

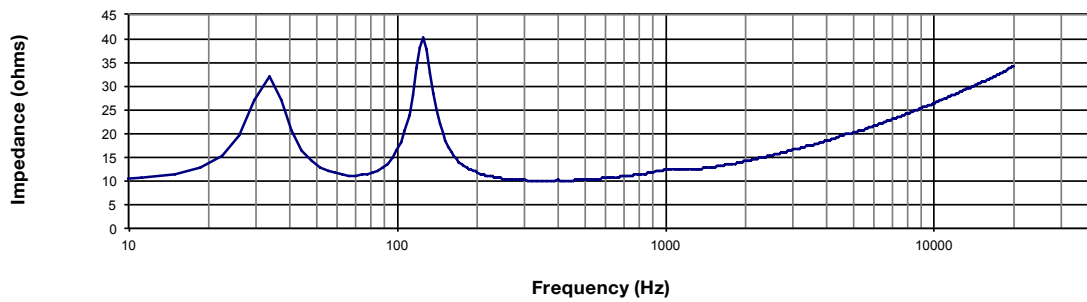

Impedance

Off-axis Frequency Response

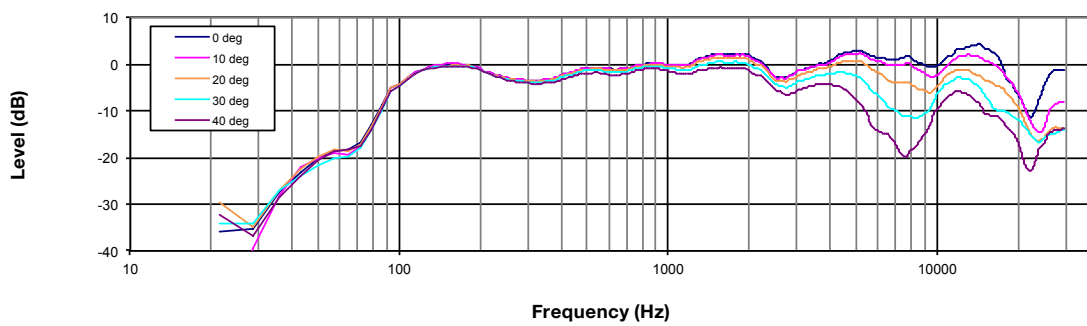

Off Axis Response

Beamwidth vs Frequency

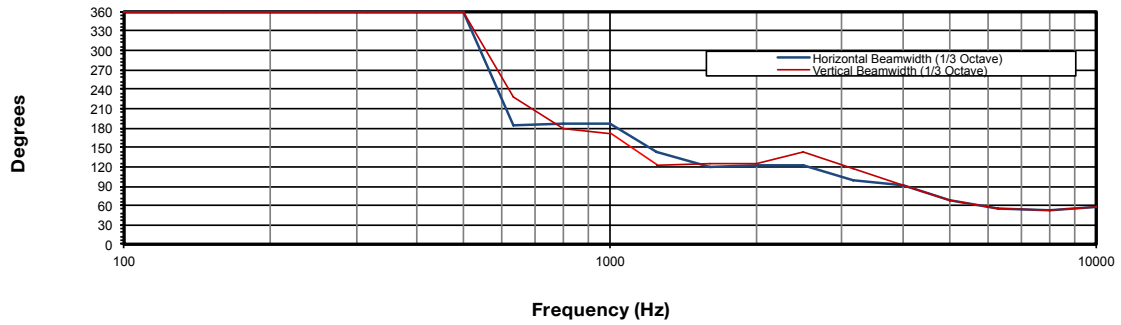

Beamwidth

Directivity Index (DI)

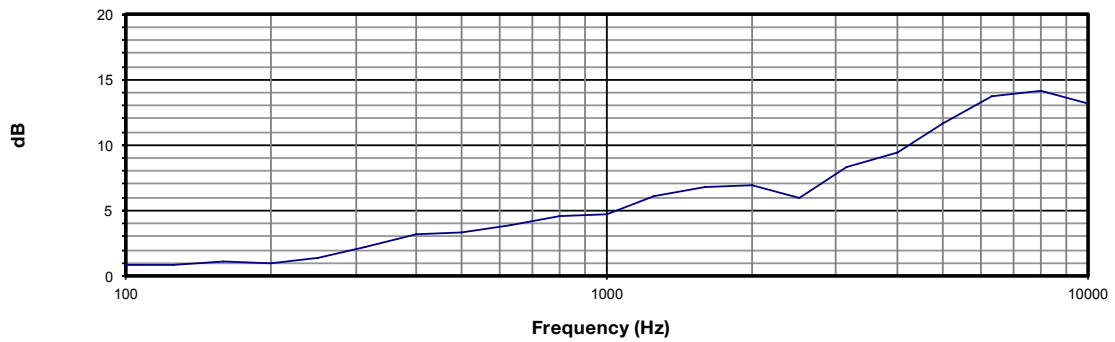

Directivity Index

Technical Data Sheet

Polar plots (1/3 octave)

AMS 5ICT LS

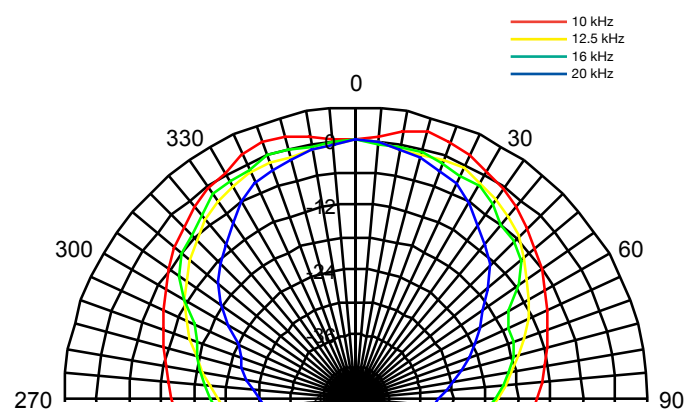
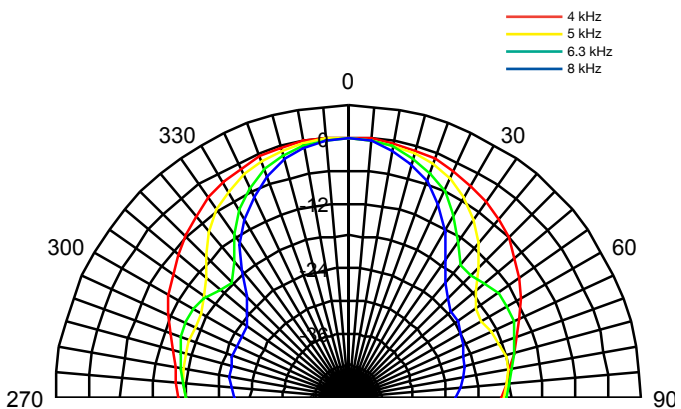
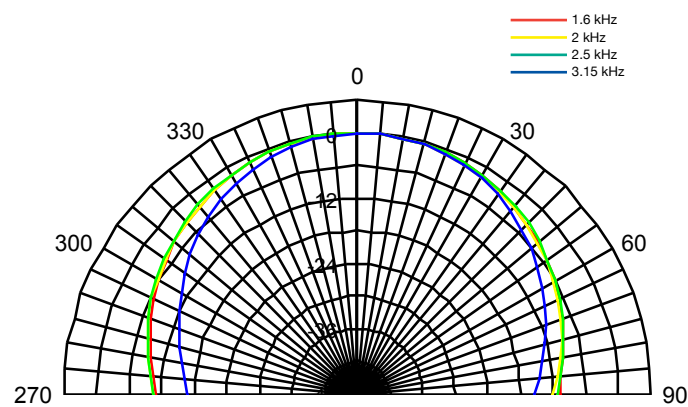
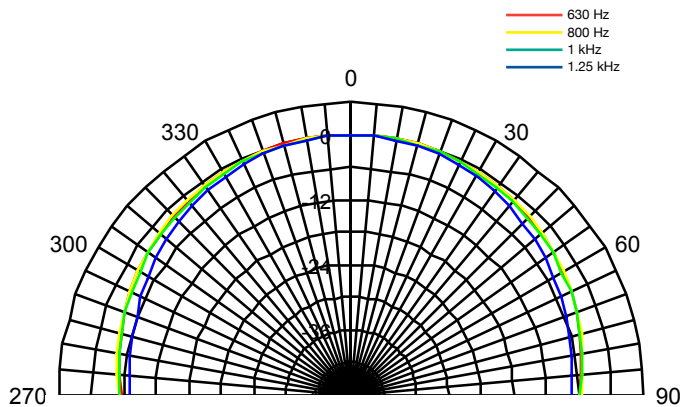
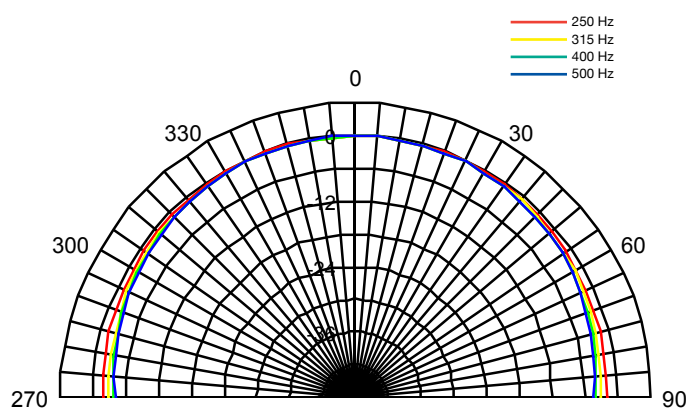
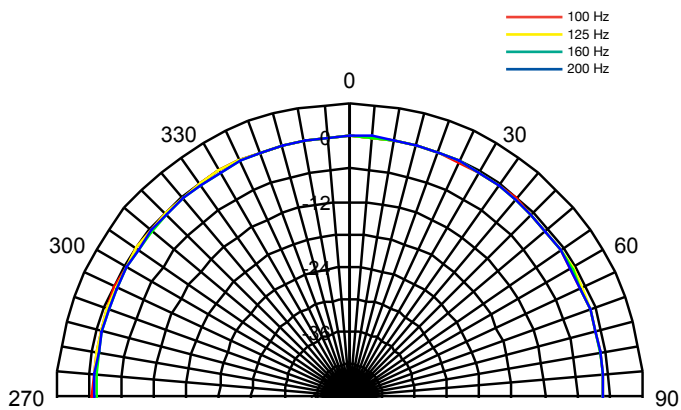

Technical Data Sheet

Specifications

AMS 5ICT LS

Performance

System	AMS 5ICT LS
Frequency response (-3 dB) ⁽¹⁾	90 Hz - 22 kHz
Frequency range (-10 dB) ⁽¹⁾	80 Hz - 30 kHz
System sensitivity (1 W @ 1m) ⁽²⁾	88 dB (1W = 4V for 16 ohms)
Nominal Coverage Angle	90 degrees conical
Power Handling ⁽³⁾	
Average	50 W
Programme	100 W
Peak	200 W
Recommended Amplifier Power	100 W @ 16 ohms
Nominal Impedance (Lo, Z)	16 ohms
Rated maximum SPL	
Average	105 dB
Peak	111 dB
Transformer Taps (via front rotary switch)	
70 V	30 W / 15 W / 7.5 W / 3.75 W / OFF & Low impedance operation
100 V	30 W / 15 W / 7.5 W / OFF & Low impedance operation

Transducers

Low Frequency	1 x 130 mm (5.00") treated multi fibre paper pulp cone
High Frequency	ICT

Physical

Enclosure	ABS
Grille	Steel, plated and painted
Connectors	Removable locking connector with screw terminals
Transformer setting	Rotary switch
Dimensions (H x W x D)	248.0 x 155.0 x 203.9 mm (9.77 x 6.10 x 8.03")
Net Weight (ea)	3.25 kg (7.16 lbs)
Shipped weight	3.66 kg (8.07 lbs)
Included Accessories	Yoke bracket
Packed Quantity	2

Ordering Information

Part Number	Colour
8001 7965	Black
8001 7966	White



Notes:

1. Average over stated bandwidth. Measured in an IEC baffle in an Anechoic Chamber
2. Unweighted pink noise input, measured at 1 metre on axis
3. Long term power handling capacity as defined in EIA - 426B test

A full range of measurements, performance data, CLF and Ease™ Data for AMS 5ICT LS can be downloaded from www.tannoypro.com.

Tannoy operates a policy of continuous research and development. The introduction of new materials or manufacturing methods will always equal or exceed the publishing specifications, which Tannoy reserves the right to alter without prior notice. Please verify the latest specifications when dealing with critical applications.

Copyright (c) 2016 Tannoy Limited. All rights reserved.