



ControlSpace

Engineered Sound Processors

ESP-880A
ESP-880AD
ESP-1240A
ESP-1240AD

Installation Guide
Guía de instalación
Guide d'installation
Installationsanleitung
Guida all'installazione
Installatiehandleiding

Please read and keep all safety and use instructions.

This product is intended for installation by professional installers only! This document is intended to provide professional installers with basic installation and safety guidelines for this product in typical fixed-installation systems. Please read this document and all safety warnings before attempting installation. Do not attempt to service this product yourself. Refer all servicing to authorized service centers, installers, technicians, dealers or distributors. To contact Bose Professional or to find a dealer or distributor near you, visit pro.Bose.com and click **Knowledge**.

1. Read these instructions.
2. Keep these instructions.
3. Heed all warnings.
4. Follow all instructions.
5. Do not use this apparatus near water.
6. Clean only with a dry cloth.
7. Do not block any ventilation openings. Install in accordance with the manufacturer's instructions.
8. Do not install near any heat sources such as radiators, heat registers, stoves, or other apparatus (including amplifiers) that produce heat.
9. Do not defeat the safety purpose of the polarized or grounding-type plug. A polarized plug has two blades with one wider than the other. A grounding type plug has two blades and a third grounding prong. The wide blade or the third prong are provided for your safety. If the provided plug does not fit into your outlet, consult an electrician for replacement of the obsolete outlet.
10. Protect the power cord from being walked on or pinched particularly at plugs, convenience receptacles, and the point where they exit from the apparatus.
11. Only use attachments/accessories specified by the manufacturer.
12.  Use only with the cart, stand, tripod, bracket, or table specified by the manufacturer, or sold with the apparatus. When a cart is used, use caution when moving the cart/apparatus combination to avoid injury from tip-over.
13. Unplug this apparatus during lightning storms or when unused for long periods of time.
14. Refer all servicing to qualified personnel. Servicing is required when the apparatus has been damaged in any way, such as power-supply cord or plug is damaged, liquid has been spilled or objects have fallen into the apparatus, the apparatus has been exposed to rain or moisture, does not operate normally, or has been dropped.

WARNINGS/CAUTIONS



This symbol on the product means there is uninsulated, dangerous voltage within the product enclosure that may present a risk of electrical shock.



This symbol on the product means there are important operating and maintenance instructions in this guide.



Contains small parts which may be a choking hazard. Not suitable for children under age 3.

All Bose products must be installed in accordance with local, state, federal and industry regulations. It is the installer's responsibility to ensure installation of the loudspeakers and mounting system is performed in accordance with all applicable codes, including local building codes and regulations. Consult the local authority having jurisdiction before installing this product.

Unsafe mounting or overhead suspension of any heavy load can result in serious injury or death, and property damage. It is the installer's responsibility to evaluate the reliability of any mounting method used for their application. Only professional installers with the knowledge of proper hardware and safe mounting techniques should attempt to install any loudspeaker overhead.

Do not mount the product in locations where condensation may occur.

This product is not intended for installation or use in indoor water facility areas (including, without limitation, indoor pools, indoor water parks, hot tub rooms, saunas, steam rooms and indoor skating rinks).

To reduce the risk of fire or electrical shock, do NOT expose this product to rain, liquids or moisture. Not applicable for products rated IPX4-9.

Keep the product away from fire and heat sources. Do NOT place naked flame sources, such as lighted candles, on or near the product.

Do NOT make unauthorized alterations to this product.

Do NOT use a power inverter with this product.

Do NOT use in vehicles or boats.

Provide an earth connection or ensure the socket outlet incorporates a protective earthing connection before connecting the plug to the mains socket outlet.

Denmark: Apparatuset stikprop skal tilsluttes en stikkontakt med jord, som giver forbindelse til stikproppens jord.

Finland: Laite on liitettävä suojamaadoituskoskettimilla varustettuun pistorasiaan.

Norway: Apparatet må tilkoples jordet stikkontakt.

Sweden: Apparatens skall anslutas till jordat uttag.

Where the mains plug or an appliance coupler is used as the disconnect device, the disconnect device shall remain readily operable.

Do not expose products containing batteries to excessive heat (e.g. from storage in direct sunlight, fire or the like).

CAUTION: Only use the mounting hardware recommended by the rack manufacturer.

Due to ventilation requirements, Bose does not recommend placing the product in a confined space such as in a wall cavity or in an enclosed cabinet.

Do not place or install the bracket or product near any heat sources, such as fireplaces, radiators, heat registers or other apparatus (including amplifiers) that produce heat.

Regulatory Information

CAN ICES-3 (A)/NMB-3(A)

WARNING: This is a class A product. In a domestic environment this product may cause radio interference in which case the user may be required to take adequate measures.

This device complies with part 15 of the FCC Rules and with Industry Canada license-exempt RSS standard(s).

Operation is subject to the following two conditions: (1) This device may not cause harmful interference, and (2) this device must accept any interference received, including interference that may cause undesired operation.

NOTE: This equipment has been tested and found to comply with the limits for a Class A digital device, pursuant to part 15 of the FCC Rules. These limits are designed to provide reasonable protection against harmful interference when the equipment is operated in a commercial environment. This equipment generates, uses, and can radiate radio frequency energy and, if not installed and used in accordance with the instruction manual, may cause harmful interference to radio communications. Operation of this equipment in a residential area is likely to cause harmful interference in which case the user will be required to correct the interference at their own expense.

Changes or modifications not expressly approved by Bose Corporation could void the user's authority to operate this equipment.

Shielded cables are required to maintain regulatory compliance.

This product meets all EN55103-2 immunity requirements for E2 electromagnetic environment.

 This product conforms to all applicable EU directive requirements. The complete declaration of conformity can be found at Bose.com/compliance



This symbol means the product must not be discarded as household waste, and should be delivered to an appropriate collection facility for recycling. Proper disposal and recycling helps protect natural resources, human health and the environment. For more information on disposal and recycling of this product, contact your local municipality, disposal service, or the shop where you bought this product.

China Restriction of Hazardous Substances Table

Part Name	Names and Contents of Toxic or Hazardous Substances or Elements					
	Lead (Pb)	Mercury (Hg)	Cadmium (Cd)	Hexavalent (CR(VI))	Polybrominated Biphenyl (PBB)	Polybrominated diphenylether (PBDE)
PCBs	X	0	0	0	0	0
Metal parts	X	0	0	0	0	0
Plastic parts	0	0	0	0	0	0
Speakers	X	0	0	0	0	0
Cables	X	0	0	0	0	0

This table is prepared in accordance with the provisions of SJ/T 11364.
0: Indicates that said hazardous substance contained in all of the homogeneous materials for this part is below the limit requirement of GB/T 26572.
X: Indicates that said hazardous substance contained in at least one of the homogeneous materials used for this part is above the limit requirement of GB/T 26572.



Taiwan Restriction of Hazardous Substances Table

台灣 BSMI 限用物質含有情況標示

設備名稱：聲音處理器，型號：812862, 812872, 812806, 812848						
限制物質及其化學符號						
裝置	鉛 (Pb)	汞 (Hg)	鎘 (Cd)	六價鉻 (Cr+6)	多溴化聯苯 (PBB)	多溴聯苯醚 (PBDE)
印刷電路板	-	0	0	0	0	0
金屬零件	-	0	0	0	0	0
塑膠零件	0	0	0	0	0	0
揚聲器	-	0	0	0	0	0
連接線	-	0	0	0	0	0

備註 1：「0」表示限制物質的濃度百分比含量未超過參考值。
 備註 2：「-」表示限制物質屬於豁免項目範圍。

Please complete and retain for your records.

Serial Number: _____
 Model Number: _____

Date of Manufacture: The eighth digit in the serial number indicates the year of manufacture; "7" is 2007 or 2017.

Bose Corporation Headquarters: 1-877-230-5639

Mexico Importer: Bose de México, S. de R.L. de C.V., Paseo de las Palmas 405-204, Lomas de Chapultepec, 11000 México, D.F. For importer & service information: +5255 (5202) 3545

EU Importer: Bose Products B.V., Gorslaan 60, 1441 RG Purmerend, The Netherlands

China Importer: Bose Electronics (Shanghai) Company Limited, Part C, Plan 9, No. 353 North Riyang Road, China (Shanghai) Pilot Free Trade Zone

Taiwan Importer: Bose Taiwan Branch, 9F-A1, No.10, Section 3, Minsheng East Road, Taipei City 104, Taiwan +886-2-2514 7676

Warranty Information

This product is covered by a limited warranty.
 For warranty details, visit pro.Bose.com.

Dante™ is a trademark of Audinate Pty Ltd. Arm is a registered trademark of Arm Limited (or its subsidiaries) in the US and/or elsewhere. ©2018 Bose Corporation. No part of this work may be reproduced, modified, distributed or otherwise used without prior written permission.

Instrucciones importantes de seguridad

Lea y conserve todas las instrucciones de uso y seguridad.

Este producto está diseñado para ser instalado únicamente por instaladores profesionales. Este documento está diseñado para proveer las pautas de seguridad e instalación básicas a los instaladores profesionales de este producto en sistemas de instalación fija comunes. Lea este documento y todas las advertencias de seguridad antes de comenzar la instalación.

No intente reparar este producto por su cuenta. Remita todas las reparaciones a centros de servicio, instaladores, técnicos o distribuidores autorizados. Para comunicarse con Bose Professional o para encontrar un distribuidor cerca de usted, visite pro.bose.com y haga clic en **Knowledge** (Información).

1. Lea estas instrucciones.
2. Guarde estas instrucciones.
3. Preste atención a las advertencias.
4. Siga todas las instrucciones.
5. No use este aparato cerca del agua.
6. Límpiolo solamente con un paño seco.
7. No obstruya ninguna abertura de ventilación. Realice la instalación conforme a las instrucciones del fabricante.
8. No lo instale cerca de una fuente de calor, como radiadores, rejillas de calefacción, estufas u otros aparatos (incluidos los amplificadores) que produzcan calor.
9. No anule el propósito de seguridad del enchufe con conexión a tierra o polarizado. Un enchufe polarizado tiene dos hojas, una más ancha que la otra. Un enchufe con conexión a tierra tiene dos clavijas planas y un tercer conector a tierra. La clavija plana más ancha o el tercer conector son para su seguridad. Si el enchufe suministrado no encaja en la toma de corriente, consulte con un electricista para cambiar la toma de corriente obsoleta.
10. Proteja el cable de alimentación para que nadie lo pise o lo perforo, especialmente en enchufes, receptáculos de tomas múltiples y en el punto donde sale del dispositivo.
11. Use solamente los accesorios especificados por el fabricante.
12.  Use solamente con el carro, el soporte de piso, el trípode, el soporte o la mesa especificados por el fabricante o vendidos con el dispositivo. Cuando se usa un carro, tenga precaución al moverlo con el dispositivo para evitar lesiones por tropiezos.
13. Desenchufe este aparato durante tormentas eléctricas o cuando no lo utilice durante períodos prolongados.
14. Derive todas las tareas de mantenimiento a personal calificado. Se requieren tareas de mantenimiento si el aparato se daña de alguna manera; por ejemplo, si se daña el enchufe o el cable de alimentación, si se derrama líquido o si caen objetos dentro del aparato, si se expone el aparato a la lluvia o la humedad, si no funciona normalmente o si se ha caído.

ADVERTENCIAS/PRECAUCIONES



Este símbolo en el producto indica que hay voltaje peligroso y sin aislamiento dentro de la carcasa del producto, lo cual podría representar un riesgo de descarga eléctrica.



Este símbolo en el producto indica que en esta guía se incluyen instrucciones de mantenimiento y funcionamiento importantes.



Contiene piezas pequeñas que pueden provocar asfixia. No recomendable para niños menores de 3 años.

Todos los productos Bose deben instalarse conforme a las leyes locales, estatales, federales y del sector. Es responsabilidad del instalador garantizar que la instalación del sistema de soporte y los altavoces se realice conforme a los códigos aplicables, incluidos los códigos y las reglamentaciones de construcción locales. Consulte a la autoridad local competente antes de instalar este producto.

El montaje inseguro o la suspensión en alturas de cualquier carga pesada puede provocar lesiones graves o la muerte, además de daños a la propiedad. Es responsabilidad del instalador evaluar la confiabilidad de cualquier método de montaje utilizado para su aplicación. Únicamente los instaladores profesionales con conocimiento de las herramientas adecuadas y las técnicas de montaje seguro deberían intentar instalar cualquier altavoz en altura. No monte el producto en lugares donde se pueda generar condensación.

Este producto no se ha diseñado para instalar o utilizar en áreas acuáticas recreativas de interior (incluidas, entre otras, piscinas de interior, parques acuáticos de interior, salas de baño caliente, saunas, cuartos de vapor y pistas de patinaje de interior).

Para reducir el riesgo de incendio o descarga eléctrica, NO exponga este producto a la lluvia, líquidos o humedad.

Mantenga el producto lejos del fuego y de fuentes de calor. NO coloque encima ni cerca del producto fuentes de llamas de fuego expuestas, como velas encendidas.

NO realice alteraciones no autorizadas a este producto.

NO use un convertidor de corriente con este producto.

NO lo use en vehículos o embarcaciones.

Proporcione una conexión a tierra o asegúrese de que la toma de corriente incorpore una conexión a tierra protegida antes de conectar el enchufe a la toma de corriente de la red eléctrica.

Si se utiliza la clavija de conexión de red eléctrica o el acoplador del artefacto como dispositivo de desconexión, este deberá permanecer listo para funcionar.

NO exponga productos con batería al calor excesivo (por ejemplo, no guardar en sitios con luz directa del sol, cerca de fuego o similar). No aplicable para productos con clasificación IPX4-9.

PRECAUCIÓN: Utilice únicamente las herramientas de montaje que recomienda el fabricante del rack.

Debido a los requisitos de ventilación, Bose no recomienda colocar el producto en espacios reducidos como una cavidad de pared o un gabinete cerrado.

No instale ni coloque el soporte ni el producto cerca de fuentes de calor, como chimeneas, radiadores, rejillas de calefacción u otros aparatos (incluidos amplificadores) que produzcan calor.

Información regulatoria

CAN ICES-3 (A)/NMB-3(A)

ADVERTENCIA: Este es un producto Clase A. En un entorno doméstico, es posible que el producto ocasione interferencia de radio, en cuyo caso el usuario puede que deba tomar las medidas adecuadas.

Este dispositivo cumple con la parte 15 de las reglas de la FCC y con las normas RSS sin licencia de la industria canadiense.

El funcionamiento está sujeto a las siguientes dos condiciones: (1) este dispositivo no debe provocar interferencias dañinas y (2) este dispositivo debe aceptar cualquier interferencia recibida, incluida la interferencia que puede causar un funcionamiento no deseado.

NOTA: Este equipo ha sido sometido a pruebas y se ha comprobado que cumple con los límites de un dispositivo digital Clase A, de acuerdo con la Parte 15 de las reglas de la FCC. Estos límites están diseñados para proporcionar una protección razonable contra interferencias perjudiciales cuando el equipo se utiliza en un entorno comercial. Este equipo genera, usa y puede irradiar energía de radiofrecuencia y, si no se instala y se usa conforme a lo indicado en el manual de instrucciones, podría causar una interferencia perjudicial a las comunicaciones de radio. El funcionamiento de este equipo en un área residencial podría llegar a provocar interferencias perjudiciales, en cuyo caso el usuario deberá corregir dichas interferencias por cuenta propia.

Los cambios o las modificaciones no aprobadas expresamente por Bose Corporation podrían invalidar la autoridad del usuario para operar el equipo.

Se requieren cables aislados para mantener el cumplimiento de las reglamentaciones.

Este producto cumple con todos los requisitos de inmunidad de EN55103-2 para un entorno electromagnético E2.



Este producto cumple los requisitos de todas las Directivas de la UE aplicables legalmente. Encontrará la declaración de conformidad completa en Bose.com/compliance



Este símbolo significa que el producto no debe desecharse como residuo doméstico y debe enviarse a una planta para tratamiento de residuos apropiada para su reciclado. Una eliminación y un reciclado adecuados ayudan a proteger los recursos naturales, la salud humana y el medioambiente. Para obtener más información acerca de la eliminación y el reciclado de este producto, comuníquese con su municipalidad local, un centro de servicios de desecho o la tienda donde compró este producto.

Complete y conserve esto en sus archivos.

Número de serie: _____

Número de modelo: _____

Fecha de fabricación: El octavo dígito del número de serie indica el año de fabricación; p. ej., "7" es 2007 o 2017.

Oficinas centrales de Bose Corporation: 1-877-230-5639

Importador para México: Bose de México, S. de R.L. de C.V., Paseo de las Palmas 405-204, Lomas de Chapultepec, 11000 México, D.F. Para obtener información sobre el servicio y el importador, comuníquese al: +5255 (5202) 3545

Importador para la UE: Bose Products B.V., Gorslaan 60, 1441 RG Purmerend, Países Bajos

Importador para China: Bose Electronics (Shanghai) Company Limited, Part C, Plan 9, N.º 353 North Riving Road, Zona franca piloto de China (Shanghai)

Importador para Taiwán: Bose Taiwan Branch, 9F-A1, N.º 10, Section 3, Minsheng East Road, Taipei City 104, Taiwán. Número telefónico: +886-2-2514 7676

Información de la garantía

Este producto está cubierto con una garantía limitada.

Para obtener información sobre la garantía, visite pro.bose.com.

Dante™ es una marca comercial de Audinate Pty Ltd. Arm es una marca comercial registrada de Arm Limited (o sus filiales) en Estados Unidos u otros países. ©2018 Bose Corporation. Ninguna parte de este trabajo podrá reproducirse, modificarse, distribuirse ni usarse sin un permiso previo por escrito.

Merci de lire et de conserver le manuel d'instruction et de respecter les consignes de sécurité.

Ce produit doit être installé par un technicien professionnel ! Ce document est destiné à fournir aux techniciens professionnels les directives de montage et de sécurité relatives à ce produit dédié à une installation fixe. Veuillez lire ce document, ainsi que l'ensemble des avertissements de sécurité avant de procéder à l'installation.

Ne tentez pas de réparer ce produit vous-même. Confiez toutes les opérations de maintenance à des centres de service, installateurs, techniciens, revendeurs ou distributeurs agréés. Pour contacter Bose Professional ou pour trouver un revendeur ou un distributeur près de chez vous, rendez-vous à l'adresse pro.bose.com et cliquez sur **Knowledge** (Connaissances).

1. Veuillez lire ces consignes.
2. Veuillez conserver ces consignes.
3. Respectez tous les avertissements.
4. Suivez toutes les consignes.
5. N'utilisez pas cet appareil à proximité d'eau ou de toute autre source d'humidité.
6. Utilisez uniquement un chiffon sec pour le nettoyage.
7. Ne bloquez jamais les orifices d'aération. Suivez les instructions du fabricant pour l'installation.
8. N'installez pas cet appareil à proximité d'une quelconque source de chaleur, telle qu'un radiateur, une arrivée d'air chaud, un four ou tout autre appareil (notamment les amplificateurs) produisant de la chaleur.
9. Veillez à profiter de la sécurité offerte par les installations de type terre ou polarisées. Les fiches polarisées sont équipées de deux bornes de largeurs différentes. Les fiches de type terre sont équipées de deux bornes et d'un orifice pour la mise à la terre. Ces deux types de dispositifs ont pour but d'assurer votre sécurité. Si la prise fournie ne s'adapte pas à votre prise de courant, consultez un électricien pour qu'il remplace cette prise obsolète.
10. Protégez le cordon d'alimentation contre les risques de piétinement ou de pincement, notamment au niveau des fiches, des prises de courant et des branchements à l'appareil.
11. Utilisez uniquement les accessoires spécifiés par le fabricant.
12.  Utilisez uniquement le chariot, le support, le trépied, l'équerre ou la table spécifié(e) par le fabricant ou vendu(e) avec l'appareil. Si vous utilisez un chariot, faites attention à ne pas faire basculer l'ensemble chariot/appareil.
13. Débranchez cet appareil pendant les orages ou au cours des longues périodes de non-utilisation.
14. Confiez toute réparation à du personnel qualifié. Une réparation est nécessaire lorsque l'appareil a été endommagé de quelque façon que ce soit (endommagement du cordon d'alimentation ou de la fiche électrique, renversement d'un liquide ou de tout objet sur l'appareil, exposition de l'appareil à la pluie ou à l'humidité, mauvais fonctionnement, chute de l'appareil, etc.).

AVERTISSEMENTS/PRÉCAUTIONS



Ce symbole sur le produit indique la présence d'une tension électrique dangereuse non isolée à l'intérieur de l'appareil, susceptible d'induire un risque de décharge électrique.



Ce symbole sur le produit signale les instructions importantes mentionnées dans le guide d'installation, relatives au fonctionnement et à l'entretien de l'appareil.



Certaines petites pièces présentent un risque de suffocation. Ne les laissez pas à la portée des enfants de moins de 3 ans.

Tous les produits Bose doivent être installés dans le respect des réglementations locales et nationales. L'installateur est responsable du respect de tous les codes et règlements locaux et nationaux en vigueur applicables à l'installation et au montage des enceintes. Consultez les autorités locales compétentes avant d'installer ce produit.

Tout montage non sécurisé d'une lourde charge peut provoquer des dégâts matériels et des blessures graves, voire la mort. Il en va de la responsabilité de l'installateur d'évaluer la fiabilité de la méthode de montage utilisée, en fonction de l'application. Seul un installateur professionnel connaissant les accessoires et techniques de montage adaptés est qualifié pour installer des enceintes suspendues.

Ne montez pas le produit dans des endroits où de la condensation peut se former.

Ce produit n'est pas destiné à être monté ou utilisé dans des installations humides en intérieur (par exemple piscine intérieure, parc aquatique intérieur, baignoire à remous, sauna, hammam, patinoire intérieure, etc.).

Pour limiter les risques d'incendie ou d'électrocution, n'exposez PAS l'appareil à la pluie, à toutes formes de liquides ou à l'humidité. Ne s'applique pas aux produits dont l'indice de protection est IPX4-9.

Tenez le produit à l'écart du feu et des sources de chaleur. Ne placez JAMAIS d'objets enflammés, tels que des bougies allumées, sur l'appareil ou à proximité.

Veillez à NE PAS effectuer de modifications non autorisées sur ce produit.

Veillez à NE PAS utiliser un convertisseur continu-alternatif avec ce produit.

Veillez à NE PAS utiliser cet appareil dans des véhicules ou des bateaux.

Avant de brancher l'appareil à une prise de courant électrique, vérifiez que celle-ci soit bien raccordée à la terre ou qu'elle est dotée d'une protection par mise à la terre.

Lorsque l'alimentation de secteur ou la prise multiple est utilisée comme dispositif de débranchement de l'appareil, le dispositif de débranchement doit rester facilement accessible.

N'exposez PAS les produits contenant des piles ou des batteries à une chaleur excessive (ne les placez pas à la lumière directe du soleil, près d'un feu ou de toute autre source de chaleur).

MISE EN GARDE : Utilisez exclusivement le matériel de montage en rack recommandé par le fabricant.

Pour assurer une ventilation correcte, Bose déconseille de placer ce produit dans un espace confiné tel qu'une cavité murale ou un placard fermé.

N'installez pas le support ou le produit à proximité d'une source de chaleur, telle qu'une cheminée, un radiateur, une arrivée d'air chaud ou tout autre appareil (notamment les amplificateurs) produisant de la chaleur.

Informations réglementaires

CAN ICES-3 (A)/NMB-3(A)

ATTENTION : Ceci est un produit de catégorie A. Dans un environnement domestique, ce produit peut provoquer des interférences radio, auquel cas l'utilisateur devra prendre des mesures adéquates.

Cet appareil est conforme à la partie 15 de la réglementation de la FCC et au(x) standard(s) RSS exempté(s) de licence d'Industrie Canada.

Son fonctionnement repose sur les deux conditions suivantes : (1) cet appareil ne doit pas provoquer d'interférences et (2) cet appareil doit tolérer les interférences externes, y compris celles qui peuvent provoquer un fonctionnement anormal.

REMARQUE : Ce matériel a fait l'objet de tests prouvant sa conformité aux limites imposées aux appareils numériques de classe A, conformément à la partie 15 des réglementations de la FCC. Ces limites sont conçues pour offrir une protection raisonnable contre les interférences nuisibles lorsque l'appareil est utilisé en environnement commercial. Cet appareil génère, utilise et est susceptible d'émettre de l'énergie à certaines fréquences radio. À ce titre, s'il n'est pas installé ou utilisé conformément aux instructions, il est susceptible de perturber les communications radio. L'utilisation de cet équipement dans une zone résidentielle risque de provoquer des interférences nuisibles, auquel cas l'utilisateur devra remédier au problème à ses propres frais.

Toute modification non autorisée expressément par Bose Corporation est susceptible d'annuler le droit de l'utilisateur à utiliser cet appareil.

Des câbles blindés doivent être utilisés pour assurer le respect des réglementations.

Ce produit répond aux critères d'immunité de la norme EN55103-2 pour les environnements électromagnétiques classés E2.



Ce produit est conforme à toutes les directives de la Communauté Européenne qui s'y appliquent. L'attestation complète de conformité est disponible à l'adresse Bose.com/compliance



Ce symbole signifie que le produit ne doit pas être jeté avec les déchets ménagers, mais doit être déposé dans un centre de collecte approprié pour recyclage. La mise au rebut adéquate et le recyclage permettent de protéger les ressources naturelles, la santé humaine et l'environnement. Pour plus d'informations sur l'élimination et le recyclage de ce produit, contactez votre mairie, votre service d'enlèvement des ordures ou le magasin où vous avez acheté ce produit.

Renseignements à noter et conserver.

Numéro de série : _____
Numéro de modèle : _____

Date de fabrication : Le huitième chiffre du numéro de série indique l'année de fabrication ; par exemple, « 7 » correspond à 2007 ou à 2017.

Siège de Bose Corporation : 1-877-230-5639

Importateur pour le Mexique : Bose de México, S. de R.L. de C.V., Paseo de las Palmas 405-204, Lomas de Chapultepec, 11000 México, D.F. Pour plus d'informations sur l'importateur et le service : +5255 (5202) 3545

Importateur pour l'UE : Bose Products B.V., Gorslaan 60, 1441 RG Purmerend, Pays-Bas

Importateur pour la Chine : Bose Electronics (Shanghai) Company Limited, Part C, Plan 9, No. 353 North Riyang Road, China (Shanghai) Pilot Free Trade Zone

Importateur pour Taïwan : Bose Taiwan Branch, 9F-A1, No. 10, Section 3, Minsheng East Road, Taipei City 104, Taiwan. Numéro de téléphone : +886-2-2514 7676

Informations relatives à la garantie

Cet appareil est couvert par une garantie limitée.

Pour en savoir plus sur la garantie, consultez la page pro.bose.com.

Dante™ est une marque commerciale d'Audinate Pty Ltd. Arm est une marque déposée de Arm Limited (ou de ses filiales) aux États-Unis et/ou dans d'autres pays. ©2018 Bose Corporation. Toute reproduction, modification, distribution ou autre utilisation, même partielle, de ce document est interdite sans autorisation écrite préalable.

Wichtige Sicherheitshinweise

Bitte lesen Sie alle Sicherheitshinweise und Gebrauchsanleitungen durch und bewahren Sie sie auf.

Dieses Produkt darf nur von fachkundigen Monteuren installiert werden! Dieses Dokument soll fachkundigen Monteuren grundlegende Installations- und Sicherheitsrichtlinien für dieses Produkt in typischen Festinstallationsystemen bieten. Bitte lesen Sie dieses Dokument und alle Sicherheitshinweise vor der Installation durch.

Versuchen Sie nicht, dieses Produkt selbst zu warten. Lassen Sie jegliche Reparatur- und Wartungsarbeiten nur von autorisierten Servicepartnern, Monteuren, Technikern, Händlern oder Vertreibern durchführen. Die Bose Professional Kontaktdaten für Ihr Land sowie Informationen zu Händlern oder Vertreibern in Ihrer Nähe finden Sie auf pro.bose.com im Bereich **Knowledge**.

1. Lesen Sie die folgenden Anweisungen.
2. Bewahren Sie die Anweisungen auf.
3. Beachten Sie alle Warn- und Sicherheitshinweise.
4. Befolgen Sie alle Anweisungen.
5. Verwenden Sie dieses Gerät nicht in der Nähe von Wasser.
6. Reinigen Sie das Gerät nur mit einem sauberen, trockenen Tuch.
7. Achten Sie darauf, dass die Lüftungsöffnungen nicht blockiert sind. Stellen Sie das Gerät nur in Übereinstimmung mit den Herstelleranweisungen auf.
8. Stellen Sie das Gerät nicht in der Nähe von Wärmequellen auf, wie zum Beispiel Heizkörpern, Wärmespeichern, Öfen oder anderen Geräten (auch Verstärkern), die Wärme erzeugen.
9. Achten Sie darauf, dass die Schutzfunktion des Schutzkontaktsteckers nicht beeinträchtigt wird. Ein gepolter Stecker hat zwei Stromkontakte, von denen einer breiter als der andere ist. Ein Schutzkontaktstecker hat zwei Stromkontakte und einen dritten Erdungskontakt. Der breitere bzw. dritte Kontakt dient Ihrer Sicherheit. Falls der mitgelieferte Stecker nicht in Ihre Steckdose passt, wenden Sie sich an einen qualifizierten Elektriker, um die Steckdose auszutauschen.
10. Verlegen Sie das Netzkabel so, dass es keine Stolpergefahr darstellt und nicht beschädigt werden kann – insbesondere im Bereich von Steckern und Steckdosen und dort, wo das Netzkabel aus dem Gerät herausgeführt wird.
11. Verwenden Sie nur Zubehör-/Anbauteile, die vom Hersteller zugelassen sind.
12.  Verwenden Sie für das Gerät nur Rollwagen, Ständer, Dreibeine, Halterungen oder Tische, die vom Hersteller zugelassen sind oder zusammen mit dem Gerät verkauft werden. Falls Sie einen Rollwagen verwenden, dürfen Sie die Einheit aus Gerät und Rollwagen nur mit Vorsicht bewegen, damit Verletzungen durch ein mögliches Umkippen ausgeschlossen sind.
13. Ziehen Sie das Netzkabel bei Gewitter oder bei längerer Nichtbenutzung des Gerätes aus der Steckdose.
14. Lassen Sie jegliche Reparatur- und Wartungsarbeiten nur von qualifiziertem Fachpersonal durchführen. Wartungsarbeiten sind in folgenden Fällen nötig: bei jeglichen Beschädigungen wie z. B. des Netzkabels oder Netzsteckers, wenn Flüssigkeiten oder Gegenstände in das Gehäuse gelangt sind, das Gerät Regen oder Feuchtigkeit ausgesetzt wurde, fallen gelassen wurde oder nicht ordnungsgemäß funktioniert.

WARNHINWEISE



Dieser Warnhinweis auf dem Produkt warnt vor nicht isolierten gefährlichen Spannungsquellen im Inneren des Produktes, die ein Stromschlagrisiko darstellen können. Es besteht die Gefahr von Stromschlägen!



Dieser Warnhinweis auf dem Produkt weist auf wichtige Bedien- und Wartungsinformationen in dieser Anleitung hin.



Enthält kleine Teile, die verschluckt werden können und eine Erstickengefahr darstellen. Nicht geeignet für Kinder unter drei Jahren.

Alle Produkte von Bose müssen gemäß den örtlichen und staatlichen Vorschriften sowie gemäß allen Branchenbestimmungen installiert werden. Der Monteur ist dafür verantwortlich, sicherzustellen, dass die Installation der Lautsprecher und der Halterung gemäß allen geltenden Vorschriften durchgeführt wird, einschließlich örtlicher Bauvorschriften und -bestimmungen. Wenden Sie sich vor der Installation dieses Produkts an die zuständige abnehmende Behörde.

Eine unsichere Befestigung schwerer Lasten oder deren Aufhängung über Kopf kann zu schweren oder tödlichen Verletzungen und Sachschäden führen. Der Monteur ist dafür verantwortlich, die Zuverlässigkeit der für die Anwendung verwendeten Befestigungstechniken zu prüfen. Nur fachkundige Monteure mit Wissen über sachgemäße Befestigungselemente und sichere Befestigungstechniken sollten Lautsprecher über Kopf installieren.

Montieren Sie das Produkt nicht an Orten, an denen Kondenswasser auftreten kann.

Dieses Produkt ist nicht für die Installation oder Verwendung in Bereichen mit Wassereinrichtungen in Innenräumen (zum Beispiel Schwimmbädern, Wasserparks, Räume mit Whirlpools, Saunas, Dampfbäder und Eislaufbahnen) gedacht.

Um Brände und Stromschläge zu vermeiden, darf dieses Produkt NICHT Regen, Flüssigkeiten oder Feuchtigkeit ausgesetzt werden. Gilt nicht für Produkte mit Klassifizierung IPX4 bis IPX9.

Halten Sie das Produkt von Feuer und Wärmequellen fern. Stellen Sie KEINE brennenden Kerzen oder ähnliches auf das Gerät oder in die Nähe des Geräts.

Nehmen Sie KEINE nicht genehmigten Änderungen an diesem Produkt vor.

Benutzen Sie das Produkt NICHT mit einem Wechselrichter.

Verwenden Sie das Produkt NICHT in Fahrzeugen oder Booten.

Nutzen Sie einen Erdungsanschluss oder stellen Sie sicher, dass an der Steckdose ein Erdungsschutz vorliegt, bevor Sie den Netzstecker an die Steckdose anschließen.

Falls Sie den Netzstecker oder eine Mehrfachsteckdose verwenden, um das Gerät von der Stromversorgung zu trennen, sollten Sie sicherstellen, dass Sie jederzeit auf den Stecker zugreifen können.

Setzen Sie Geräte, die Batterien enthalten, NICHT übermäßig hohen Temperaturen aus (in dem Sie sie z. B. direkter Sonneneinstrahlung aussetzen oder in der Nähe von Feuer usw. lagern).

VORSICHT: Verwenden Sie nur die vom Rack-Hersteller empfohlenen Montagehilfsmittel.

Aufgrund der Belüftungsanforderungen sollten Sie das Produkt nicht in einem geschlossenen Raum, zum Beispiel in einer Wandnische oder in einem geschlossenen Schrank, aufstellen.

Montieren oder platzieren Sie das Gerät nicht in der Nähe von Wärmequellen wie Heizkörpern, Wärmespeichern oder anderen Geräten.

Gesetzliche Hinweise

CAN ICES-3 (A)/NMB-3(A)

WARNUNG: Dies ist ein Produkt der Klasse A. Das Produkt kann im Wohnbereich Funkstörungen verursachen. In diesem Fall kann es für den Betreiber erforderlich sein, entsprechende Maßnahmen zu ergreifen.

Dieses Gerät erfüllt die Bestimmungen in Teil 15 der FCC-Vorschriften und die lizenzfreien Standards von Industry Canada.

Der Betrieb unterliegt den beiden folgenden Bedingungen: (1) dieses Gerät darf keine Störungen verursachen und (2) dieses Gerät muss jegliche Störungen tolerieren, einschließlich Störungen, die zu unerwünschten Betriebsstörungen führen.

HINWEIS: Dieses Gerät wurde geprüft. Es stimmt mit den Regelungen für Geräte der Klasse A gemäß Teil 15 der FCC-Vorschriften überein. Diese Grenzwerte sollen einen angemessenen Schutz gegen elektromagnetische Störungen beim Betrieb in gewerblicher Umgebung gewährleisten. Dieses Gerät erzeugt und verwendet Hochfrequenzstrahlung und kann sie auch aussenden. Daher verursacht das Gerät, wenn die Installation und Benutzung nicht in Übereinstimmung mit dieser Bedienungsanleitung erfolgt, möglicherweise Störungen des Funkverkehrs. Beim Betrieb dieses Geräts in Wohngebieten können erhebliche Störungen des Funkverkehrs verursacht werden. Eventuell daraus entstehende Kosten trägt allein der Benutzer des Geräts.

Veränderungen am Gerät, die nicht durch die Bose Corporation autorisiert wurden, können zur Folge haben, dass die Betriebserlaubnis für das Gerät erlischt.

Abgeschirmte Kabel müssen den gesetzlichen Vorschriften entsprechen.

Dieses Produkt erfüllt alle Anforderungen nach EN55103-2 für elektromagnetische Verträglichkeit.



Dieses Produkt erfüllt alle vorgeschriebenen EU-Richtlinien. Die vollständige Konformitätserklärung ist einsehbar unter Bose.com/compliance



Dieses Symbol bedeutet, dass das Produkt nicht mit dem Hausmüll entsorgt werden darf, sondern bei einer geeigneten Sammelstelle für das Recycling abgegeben werden muss. Die ordnungsgemäße Entsorgung und das Recycling tragen dazu bei, die natürlichen Ressourcen, die Gesundheit und die Umwelt zu schützen. Weitere Informationen zur Entsorgung und zum Recycling dieses Produkts erhalten Sie von Ihrer zuständigen Kommune, Ihrem Entsorgungsdienst oder dem Geschäft, in dem Sie dieses Produkt gekauft haben.

Bitte ausfüllen und aufbewahren.

Seriennummer: _____

Modellnummer: _____

Herstellungsdatum: Die achte Ziffer in der Seriennummer gibt das Herstellungsjahr an; „7“ ist 2007 oder 2017.

Hauptsitz der Bose Corporation: 1-877-230-5639

Importeur aus Mexiko: Bose de México, S. de R.L. de C.V., Paseo de las Palmas 405-204, Lomas de Chapultepec, 11000 México, D.F. Importeur- und Serviceinformationen erhalten Sie unter: +5255 (5202) 3545

Importeur aus der EU: Bose Products B.V., Gorslaan 60, 1441 RG Purmerend, Niederlande

Importeur aus China: Bose Electronics (Shanghai) Company Limited, Part C, Plan 9, No. 353 North Riyang Road, China (Shanghai) Pilot Free Trade Zone

Importeur aus Taiwan: Bose Taiwan Branch, 9F-A1, No. 10, Section 3, Minsheng East Road, Taipei City 104, Taiwan. Tel.: +886-2-2514 7676

Garantiehinweise

Für dieses Produkt gilt eine eingeschränkte Garantie.

Einzelheiten zur Garantie finden Sie unter pro.bose.com.

Dante™ ist eine Marke von Audinate Pty Ltd. Arm ist eine eingetragene Marke von Arm Limited (oder seinen Tochterunternehmen) in den USA und/oder anderen Ländern. ©2018 Bose Corporation. Dieses Dokument darf ohne vorherige schriftliche Genehmigung weder ganz noch teilweise reproduziert, verändert, vertrieben oder in anderer Weise verwendet werden.

Leggere e conservare tutte le istruzioni per la sicurezza e per l'uso.

Questo prodotto deve essere installato esclusivamente da installatori professionisti. Il presente documento ha lo scopo di fornire agli installatori professionisti le istruzioni di base per l'installazione e la sicurezza del prodotto in tipici impianti da installazione fissa. Prima dell'installazione, leggere questo documento e le avvertenze sulla sicurezza.

Non tentare di riparare il prodotto autonomamente. Per tutti gli interventi di assistenza, rivolgiti ai centri assistenza, agli installatori, ai tecnici, ai rivenditori o ai distributori autorizzati. Per contattare Bose Professional o per trovare il rivenditore o distributore più vicino, visita pro.bose.com e fai clic su **Knowledge**.

1. Leggere queste istruzioni.
2. Conservare queste istruzioni.
3. Prestare attenzione a tutte le avvertenze.
4. Seguire tutte le istruzioni.
5. Non utilizzare l'apparecchio in prossimità di acqua.
6. Per la pulizia utilizzare un semplice panno asciutto.
7. Non ostruire le aperture di ventilazione. Installare il prodotto in conformità con le istruzioni fornite dal produttore.
8. Non installare in prossimità di fonti di calore, quali termosifoni, radiatori, stufe o altri apparecchi (compresi gli amplificatori) che generino calore.
9. Non danneggiare le parti di sicurezza della spina polarizzata o con messa a terra. Una spina polarizzata è dotata di due poli, uno più largo dell'altro. Una spina con messa a terra è dotata di due poli e di un terzo terminale di massa. Il polo più largo e il terzo terminale sono presenti per sicurezza. Se la spina in dotazione non è adatta alla presa, rivolgersi a un elettricista per la sostituzione della presa obsoleta.
10. Evitare che il cavo di alimentazione venga calpestato o schiacciato, soprattutto in corrispondenza di spine, prese e nel punto di uscita dell'apparecchio.
11. Utilizzare solo sistemi di fissaggio/accessori specificati dal produttore.
12.  Utilizzare solo carrelli, supporti, treppiedi, staffe o tavoli specificati dal produttore o venduti insieme all'apparecchio. Quando si utilizza un carrello, prestare attenzione durante lo spostamento dell'insieme carrello/apparecchio per evitare di rovesciarlo causando danni.
13. Scollegare l'apparecchio durante i temporali o quando non utilizzato per lunghi periodi di tempo.
14. Affidarsi a personale qualificato per tutti gli interventi di assistenza. Gli interventi di assistenza si rendono necessari in caso di danni di qualsiasi tipo all'apparecchio; ad esempio se il cavo di alimentazione o la spina sono danneggiati, se è stato versato liquido o sono caduti oggetti sull'apparecchio, se l'apparecchio è stato esposto a pioggia o umidità, se non funziona normalmente o è caduto.

AVVISI/AVVERTENZE



Questo simbolo sul prodotto indica la presenza di tensioni pericolose non isolate all'interno del telaio del prodotto e del conseguente rischio di scosse elettriche.



Questo simbolo sul prodotto segnala istruzioni importanti di funzionamento e di manutenzione presenti in questa guida.



Contiene pezzi di piccole dimensioni che possono rappresentare un pericolo di soffocamento. Non adatto per bambini di età inferiore a 3 anni.

Questo prodotto deve essere installato esclusivamente da installatori professionisti. Il presente documento ha lo scopo di fornire agli installatori professionisti le istruzioni di base per l'installazione e la sicurezza del prodotto in tipici impianti da installazione fissa. Prima dell'installazione, leggere questo documento e le avvertenze sulla sicurezza.

L'installazione non sicura o la sospensione di carichi pesanti può causare gravi lesioni alle persone e danni alle cose. È responsabilità dell'installatore valutare l'affidabilità del metodo di installazione utilizzato per l'applicazione specifica. L'installazione di un diffusore in posizione elevata può essere affidata solo ad installatori professionisti esperti di tecniche di montaggio sicuro dell'hardware.

Non posizionare il prodotto in punti dove potrebbe formarsi condensa.

Questo prodotto non deve essere installato o utilizzato in aree di servizio o intrattenimento vicine all'acqua (ad esempio, piscine coperte, parchi acquatici al chiuso, sale con vasche riscaldate, saune, bagni turchi e piste di pattinaggio al chiuso).

Per ridurre il rischio di incendio o scosse elettriche, il prodotto NON deve essere esposto a pioggia, liquidi o umidità. Non si applica ai prodotti con grado di protezione IPX4-9.

Tenere il prodotto lontano dal fuoco e da fonti di calore. NON collocare sorgenti di fiamme libere (ad esempio, candele accese) sul prodotto o in prossimità di esso.

NON apportare alterazioni non autorizzate al prodotto.

NON utilizzare inverter di potenza con questo prodotto.

NON utilizzare all'interno di veicoli o imbarcazioni.

Dotare la presa di messa a terra oppure accertarsi che la stessa sia dotata di messa a terra di protezione prima di collegare la spina di alimentazione.

La spina dell'alimentazione o dell'accoppiatore deve essere raggiungibile facilmente e rapidamente se utilizzata come dispositivo di spegnimento.

NON esporre prodotti contenenti batterie a calore eccessivo (ad esempio luce diretta del sole, fuoco o simili).

AVVERTENZA: Utilizzare esclusivamente l'hardware di montaggio raccomandato dal produttore dell'unità rack.

A causa dei requisiti di ventilazione, Bose sconsiglia di posizionare il prodotto in spazi chiusi o angusti, ad esempio nicchie a parete o armadietti.

Non posizionare o installare la staffa o il prodotto in prossimità di fonti di calore, quali caminetti, termosifoni, radiatori o altri apparati (inclusi amplificatori) che emettono calore.

Informazioni sulle normative

CAN ICES-3 (A)/NMB-3(A)

AVVERTIMENTO: Prodotto di Classe A. In ambienti domestici, il prodotto può causare interferenze radio che potrebbero richiedere misure adeguate da parte dell'utente.

Questo dispositivo è conforme alla parte 15 delle Norme FCC e agli standard Industry Canada RSS esenti da licenza.

Il funzionamento è soggetto alle due seguenti condizioni: (1) il dispositivo non può causare interferenze dannose e (2) deve accettare le interferenze ricevute, incluse quelle che potrebbero causare un funzionamento indesiderato del dispositivo.

NOTA: Questa apparecchiatura è stata sottoposta a collaudo ed è risultata conforme ai limiti relativi ai dispositivi digitali di Classe A previsti dalla Parte 15 delle norme FCC. Tali limiti sono stati fissati allo scopo di assicurare un'adeguata protezione da interferenze nocive quando l'apparecchiatura è utilizzata in un'installazione commerciale. Questa apparecchiatura genera, utilizza e può irradiare energia a radiofrequenza e, se non installata e utilizzata in conformità con il manuale di istruzioni, può causare interferenze con le locali comunicazioni radiofoniche. L'utilizzo di questa apparecchiatura in un'area residenziale può provocare interferenze nocive, nel qual caso l'utente dovrà adottare misure correttive a proprie spese.

Eventuali modifiche o alterazioni non espressamente approvate da Bose Corporation possono rendere nulla l'autorizzazione dell'utente all'utilizzo dell'apparecchiatura stessa.

La conformità alle normative richiede l'utilizzo di cavi schermati.

Il prodotto è conforme a tutti i requisiti di immunità EN55103-2 per ambienti elettromagnetici di tipo E2.



Questo prodotto è conforme a tutte le direttive EU prescritte dalla legge. La dichiarazione di conformità completa è disponibile all'indirizzo Bose.com/compliance



Questo simbolo indica che il prodotto non deve essere smaltito con i rifiuti domestici, ma deve essere consegnato a una struttura di raccolta appropriata per il riciclaggio. Uno smaltimento e un riciclo corretti aiutano a preservare le risorse naturali, la salute e l'ambiente. Per ulteriori informazioni sullo smaltimento e sul riciclo di questo prodotto, rivolgerti alle autorità locali, al servizio di smaltimento dei rifiuti o al negozio presso il quale è stato acquistato.

Compilare e conservare le seguenti informazioni.

Numero di serie: _____
Numero di modello: _____

Data di produzione: l'ottava cifra del numero di serie corrisponde all'anno di produzione; ad esempio "7" indica 2007 o 2017.

Sede principale di Bose Corporation: 1-877-230-5639

Importatore per il Messico: Bose de México, S. de R.L. de C.V., Paseo de las Palmas 405-204, Lomas de Chapultepec, 11000 México, D.F. Per informazioni su importatori e servizi: +5255 (5202) 3545

Importatore per l'UE: Bose Products B.V., Gorslaan 60, 1441 RG Purmerend, Paesi Bassi

Importatore per la Cina: Bose Electronics (Shanghai) Company Limited, Part C, Plan 9, No. 353 North Riving Road, China (Shanghai) Pilot Free Trade Zone

Importatore per Taiwan: Bose Taiwan Branch, 9F-A1, No.10, Section 3, Minsheng East Road, Taipei City 104, Taiwan. N. telefono: +886-2-2514 7676

Informazioni sulla garanzia

Questo prodotto è coperto da una garanzia limitata.

Per i dettagli sulla garanzia, visitare pro.bose.com.

Dante™ è un marchio di Audinate Pty Ltd. Arm è un marchio registrato di Arm Limited (o delle sue consociate) negli Stati Uniti e/o in altri Paesi. ©2018 Bose Corporation. Nessuna parte di questo documento può essere riprodotta, modificata, distribuita o usata in altro modo senza previa autorizzazione scritta.

Belangrijke veiligheidsinstructies

Lees alle veiligheidsinstructies en de gebruiksaanwijzing door en bewaar deze.

Dit product is uitsluitend bestemd voor installatie door professionele installateurs! Dit document is bedoeld om professionele installateurs essentiële installatie- en veiligheidsrichtlijnen te bieden voor dit product in standaardstelsels voor vaste installatie. Lees dit document en alle veiligheidsaankondigingen voordat u een systeem probeert te installeren.

Probeer dit product niet zelf te repareren. Neem voor alle onderhoud contact op met een geautoriseerd servicecenter, installateur, technicus, dealer of distributeur. Om contact op te nemen met Bose Professional en voor informatie over de dichtstbijzijnde dealer of distributeur, gaat u naar pro.bose.com en klikt u op **Knowledge**.

1. Lees deze instructies door.
2. Bewaar deze instructies.
3. Neem alle waarschuwingen in acht.
4. Volg alle instructies.
5. Gebruik dit apparaat niet in de buurt van water.
6. Alleen met een droge doek reinigen.
7. Zorg dat u de ventilatieopeningen niet blokkeert. Installeer het apparaat volgens de instructies van de fabrikant.
8. Installeer het product niet in de buurt van warmtebronnen, zoals radiatoren, warmtebronnen, kachels of andere apparaten (waaronder versterkers) die warmte produceren.
9. Schakel de veiligheidsfunctie van de gepolariseerde of geaarde stekker niet uit. Een gepolariseerde stekker heeft twee poten, waarvan de ene breder is dan de andere. Een geaarde stekker heeft twee poten en een pin voor de aarding. De bredere poot of de derde poot is bedoeld voor uw veiligheid. Als de bijgeleverde stekker niet in het stopcontact past, neem dan contact op met een elektricien om het verouderde stopcontact te vervangen.
10. Zorg dat er niet op het netsnoer wordt gestaan of gelopen en dat het niet wordt afgeknelde, met name bij de stekkers en stopcontacten en het punt waar deze uit het apparaat komen.
11. Gebruik uitsluitend aansluitstukken/accessoires die door de fabrikant worden gespecificeerd.
12.  Gebruik het apparaat uitsluitend in combinatie met het verrijdbare plateau, het statief, de beugel of de tafel die door de fabrikant worden vermeld of samen met het apparaat worden verkocht. Als u een verrijdbaar plateau gebruikt, moet u het apparaat en het plateau voorzichtig verplaatsen zodat deze niet kunnen omvallen en letsel veroorzaken.
13. Haal de stekker van dit apparaat uit het stopcontact bij onweer of als het langere tijd niet wordt gebruikt.
14. Laat alle reparaties en onderhoud over aan bevoegde personen. Reparatie is vereist als het apparaat is beschadigd, zoals wanneer het snoer of de stekker van de voeding is beschadigd, wanneer er vloeistof in het apparaat is terechtgekomen of voorwerpen in het apparaat zijn gevallen, wanneer het apparaat is blootgesteld aan regen of vocht, niet normaal werkt of is gevallen.

WAARSCHUWINGEN



Dit symbool op het product betekent dat er een niet-geïsoleerde, gevaarlijke spanning aanwezig is binnen de behuizing van het product die kan leiden tot een risico op elektrische schokken.



Dit symbool op het product betekent dat deze handleiding belangrijke bedienings- en onderhoudsinstructies bevat. n this guide.



Bevat kleine onderdelen die verstikkingsgevaar kunnen vormen. Niet geschikt voor kinderen jonger dan 3 jaar.

Alle Bose-producten moeten worden geïnstalleerd volgens de plaatselijke en landelijke voorschriften en industriënormen. Het is de verantwoordelijkheid van de installateur om ervoor te zorgen dat de installatie van de luidsprekers en het montagesysteem gebeurt met inachtneming van alle van toepassing zijnde voorschriften, waaronder plaatselijke bouwvoorschriften. Neem contact op met de juiste plaatselijke overheidsinstanties voordat u dit product installeert.

Het onveilig monteren of ophangen van een zware last kan leiden tot beschadiging van uw eigendommen, ernstig letsel en overlijden. Het is de verantwoordelijkheid van de installateur om de betrouwbaarheid te evalueren van de gebruikte montagetechniek. Alleen professionele installateurs met kennis van het juiste gereedschap en veilige montagetechnieken mogen luidsprekers hoog ophangen.

Monteer het product niet op locaties waar condensatie kan optreden.

Dit product is niet bedoeld voor installatie of gebruik in overdekte ruimten voor wateractiviteiten (waaronder overdekte zwembaden, overdekte waterparken, stoomruimten, sauna's, bubbelbadkamers en overdekte ijsbanen).

Om het risico op brand of elektrische schokken te verlagen, mag het product NIET worden blootgesteld aan regen, vloeistof of vocht. Niet van toepassing op producten met IPX-classificatie 4-9.

Houd het product uit de buurt van vuur en warmtebronnen. Plaats GEEN open vlammen, zoals brandende kaarsen, op of bij het product.

Er mogen GEEN wijzigingen aan dit product worden aangebracht door onbevoegden.

Gebruik GEEN omvormer in combinatie met dit product.

Gebruik het NIET in voertuigen of boten.

Zorg voor aarding of controleer of het stopcontact geaard is voordat u de stekker in het stopcontact steekt.

Wanneer de stekker of aansluiting van een apparaat als stroomonderbreker wordt gebruikt, dient deze stroomonderbreker steeds goed bereikbaar te zijn.

Producten die accu's of batterijen bevatten NIET blootstellen aan overmatige warmte (zoals direct zonlicht, vuur en dergelijke).

VOORZICHTIGHEID: Gebruik uitsluitend het door de fabrikant aanbevolen montage materiaal.

Omwille van de ventilatievereisten raadt Bose af om het product in een besloten ruimte te plaatsen, zoals in een nis in de muur of een dichte kast.

Plaats of installeer de beugel of het product niet in de buurt van warmtebronnen, zoals open haarden, radiatoren, verwarmingsroosters of andere apparaten (waaronder versterkers) die warmte produceren.

Wettelijk verplichte informatie

CAN ICES-3 (A)/NMB-3(A)

WAARSCHUWING: Dit is een product van klasse A. Dit product kan in een woonomgeving radio-interferentie veroorzaken, zodat de gebruiker mogelijk passende maatregelen moet treffen.

Dit apparaat voldoet aan deel 15 van de FCC-voorschriften en de RSS-norm(en) van Industry Canada voor vergunningsvrije apparaten.

Op het gebruik zijn de volgende twee voorwaarden van toepassing: (1) Dit apparaat mag geen schadelijke storing veroorzaken, en (2) dit apparaat moet bestand zijn tegen alle externe storing, waaronder storing die een ongewenste werking tot gevolg kan hebben.

OPMERKING: Dit apparaat is getest en voldoet aan de limieten voor een digitaal apparaat van de klasse A, volgens deel 15 van de FCC-voorschriften. Deze limieten zijn bedoeld om redelijke bescherming te bieden tegen schadelijke storing bij installatie in een handelsomgeving. Dit apparaat genereert en gebruikt radiofrequente energie en kan deze uitstralen en het kan, als het niet wordt geïnstalleerd en gebruikt volgens de instructies, schadelijke storing veroorzaken aan radiocommunicatie. Gebruik van dit apparaat in een woonwijk kan schadelijke storing veroorzaken. In dit geval moet de gebruiker de storing op eigen kosten verhelpen.

Veranderingen of aanpassingen die niet uitdrukkelijk zijn goedgekeurd door Bose Corporation kunnen leiden tot het vervallen van de bevoegdheid van de gebruiker om dit apparaat te gebruiken.

Afgeschermde kabels zijn vereist om aan de regelgeving te voldoen.

Dit product voldoet aan alle immuniteitsvereisten van EN55103-2 voor een E2 elektromagnetische omgeving.

 Dit product voldoet aan alle vereisten van de EU-richtlijnen, zoals wettelijk vereist. De volledige conformiteitsverklaring kunt u vinden op Bose.com/compliance



Dit symbool betekent dat het product niet mag worden weggegooid als huishoudelijk afval en naar een geschikt inzamelpunt voor recycling moet worden gebracht. Het op de juiste wijze afvoeren en recycleren helpt natuurlijke hulpbronnen, de menselijke gezondheid en het milieu te beschermen. Voor meer informatie over het afvoeren en recycleren van dit product neemt u contact op met de gemeente waar u woont, de afvalverwerkingsdienst of de winkel waar u dit product hebt gekocht.

Vul het volgende in en bewaar deze informatie voor uw administratie.

Serienummer: _____

Modelnummer: _____

Fabricagedatum: Het achtste cijfer in het serienummer geeft het fabricagejaar aan. '7' is 2007 of 2017.

Hoofdkantoor Bose Corporation: 1-877-230-5639

Importeur in Mexico: Bose de México, S. de R.L. de C.V., Paseo de las Palmas 405-204, Lomas de Chapultepec, 11000 México, D.F. Gegevens importeur en service-informatie: +52 55 52 02 35 45

Importeur in de EU: Bose Products B.V., Gorslaan 60, 1441 RG Purmerend, Nederland

Importeur in China: Bose Electronics (Shanghai) Company Limited, Part C, Plan 9, No. 353 North Riving Road, China (Shanghai) Pilot Free Trade Zone

Importeur in Taiwan: Bose Taiwan Branch, 9F-A1, No.10, Section 3, Minsheng East Road, Taipei City 104, Taiwan. Telefoonnummer: +886 2 25 14 76 76

Garantie-informatie

Dit product wordt gedekt door een beperkte garantie.

Ga naar pro.bose.com voor garantie-informatie.

Dante™ is een handelsmerk van Audinate Pty Ltd. Arm is een geregistreerd handelsmerk van Arm Limited (of diens gelieerde ondernemingen) in de VS en/of elders. ©2018 Bose Corporation. Niets in deze uitgave mag worden gereproduceerd, gewijzigd, gedistribueerd of op andere wijze worden gebruikt zonder voorafgaande schriftelijke toestemming.

Introduction	10
Product Features	10
Available Accessories	11
Product Overview	12
ESP-880A	12
Front Panel	12
Rear Panel	12
ESP-880AD	13
Front Panel	13
Rear Panel	13
ESP-1240A	14
Front Panel	14
Rear Panel	14
ESP-1240AD	15
Front Panel	15
Rear Panel	15
Hardware Installation	16
1. Downloading & Installing ControlSpace Designer	16
2. Unpacking the Carton	17
3. Rack-mounting the Processor	18
4. Connecting Analog Audio Devices	18
5. Connecting ControlCenter, AmpLink & Serial Control Devices	19
6. Connecting Dante-compatible Devices	19
7. Connecting GPIO Devices	20
8. Connecting to a Network	21
9. Connecting to Power	21
10. Configuring the Processor with ControlSpace Designer	21
Maintenance Operations	22
Firmware & Software Upgrades	22
Battery Replacement	22
Troubleshooting	22
Technical Specifications	24
ESP-880A	24
ESP-880AD	26
ESP-1240A	28
ESP-1240AD	30
Software License Disclosure	31

Introduction

The Bose ControlSpace **ESP-880A/ESP-880AD/ESP-1240A/ESP-1240AD** engineered sound processor is an open-architecture DSP with 8×8 / 12×4 analog audio and a Bose AmpLink output, designed for a wide variety of applications ranging from small self-contained projects to larger networked applications. It offers advanced digital signal processing with 48 kHz/24-bit audio conversion, ultra-low noise, and low-latency operation for sound system precision.

Open-architecture configuration and control is achieved using Bose ControlSpace Designer software, where a large set of signal processing modules, such as automatic mic mixers, multiband graphic and parametric EQs, Bose loudspeaker libraries, signal generators, routers, mixers, AGCs, duckers, gates, compressors, source selectors and delays offer an elevated level of functionality for most installed audio installations.

Onboard connectivity includes RS-232, 5 control inputs, 5 control outputs, onboard and 8-channel Bose AmpLink to send digital audio to AmpLink-equipped Bose amplifiers. The ESP-880AD/ESP-1240AD includes 32×32 Dante™ audio networking connectivity and front- and rear-panel Ethernet ports for configuration and control. The ESP-880AD/ESP-1240AD also supports integration with industry-standard control systems, such as Crestron and AMX and can be used with any of the compatible Bose Professional end-user controls such as the ControlCenter zone controllers and ControlSpace Remote for wireless control from mobile devices.

Product Features

High-quality analog circuitry offers both mic and line-level I/O, operates with ultra-low noise and 115 dB dynamic range

Advanced digital signal processing supports audio at 48 kHz sample rate/24-bit, uses a floating-point open architecture DSP and operates at low latencies for sound system precision

Integrated Dante audio networking supports 32×32 audio channels for connection to other Dante-enabled products (ESP-880AD/ESP-1240AD only)

Built-in Bose AmpLink output sends digital audio to AmpLink-equipped Bose amplifiers

Bose ControlSpace Designer software enables a large set of signal processing modules, such as automatic mic mixing, multiband graphic and parametric EQs, Bose loudspeaker libraries, signal generators, routers, mixers, AGCs, duckers, gates, compressors, source selectors and delays

Front panel RJ-45 Ethernet connection enables localized configuration and monitoring, while enabling network passthrough with the rear-panel network ports (ESP-880AD/ESP-1240AD only)

A variety of control options: ControlSpace ESP products are compatible with the programmable Bose CC-64 and CC-16 controllers, ControlCenter zone controllers and ControlSpace Remote clients.

Integration with industry-standard control systems using a comprehensive serial protocol through onboard RS-232 and Ethernet ports

Available Accessories

ESP-880A, ESP-880AD, ESP-1240A and ESP-1240AD processors are compatible with Bose programmable controllers and simplified volume/zone controls. These processors work with the following interfaces:

Model	Part Number	Notes
ControlSpace CC-64 control center	PC 041760	Provides network control of any Bose networkable hardware.
ControlSpace CC-16 zone controller	PC 041761	Uses CC-16 port. Up to 15 devices can be used with any Bose ESP engineered sound processor.
ControlSpace CC-4 room controller	PC 042023	Uses GPI port. Requires five control inputs and one ground termination.
ControlSpace CC-3D control center	PC 079061 (US, white) PC 079047 (US, black) PC 079053 (EU, white) PC 079058 (EU, black) PC 079041 (Japan, white) PC 079064 (Japan, black)	Uses Ethernet port. Requires additional Power-over-Ethernet (PoE) switch.
ControlSpace CC-2D control center	PC 079063 (US, white) PC 079043 (US, black) PC 079071 (EU, white) PC 079049 (EU, black) PC 079066 (Japan, white) PC 079046 (Japan, black)	Uses Ethernet port. Requires additional Power-over-Ethernet (PoE) switch.
ControlSpace CC-1D control center	PC 079059 (US, white) PC 079051 (US, black) PC 079042 (EU, white) PC 079070 (EU, black) PC 079062 (Japan, white) PC 079060 (Japan, black)	Uses Ethernet port. Requires additional Power-over-Ethernet (PoE) switch.
Volume Control with A/B switch user interface	PC 041967	Uses GPI port. Requires two control inputs and one ground termination.
Volume Control user interface	PC 041966	Uses GPI port. Requires one control input and one ground termination.

Product Overview

ESP-880A

Front Panel

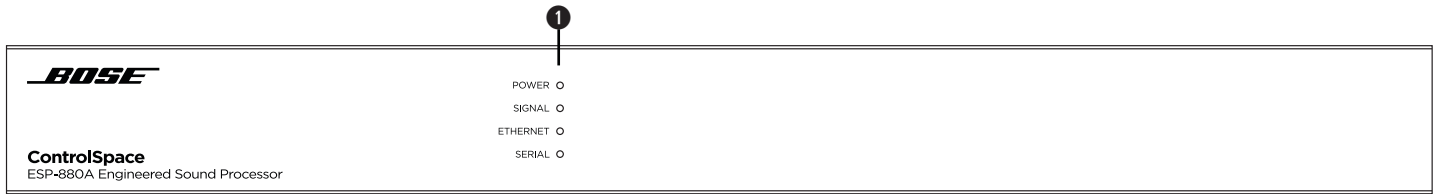

1 LED Indicators:

Power:	Power or fault state indication.	Green: Power on, normal operation Yellow: Powering on Red: Error (see Troubleshooting on page 22)
Signal:	Signal status indication of all audio input and output channels in order of signaling priority. For precise metering and gain control, connect using ControlSpace Designer software.	Green: Signal present (-60 dBFS to -20 dBFS) Yellow: Signal level optimal (-20 dBFS to -2 dBFS) Red: Clipping (-2 dBFS to 0 dBFS)
Ethernet:	Connection status indication of Ethernet ports.	Green: Ethernet link established Yellow: Active transmission/reception
Serial:	Serial command status indication for CC-16 zone controller or RS-232 device.	Green: CC-16 controller command transmitted Yellow: CC-16 controller command received Red: Active RS-232 transmission/reception

Rear Panel

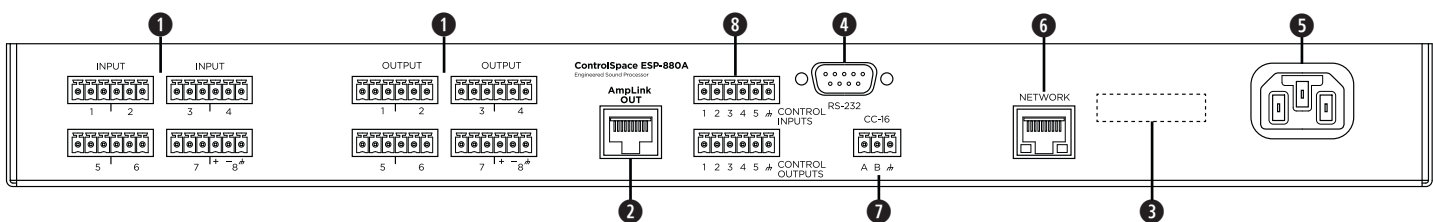

- 1 **Audio Inputs & Outputs:** Mic-/line-level inputs and line-level outputs balanced analog audio signals. See **4. Connecting Analog Audio Devices** (page 18) for more information.
- 2 **AmpLink Out port:** Ethernet connection for use with AmpLink-equipped PowerMatch amplifiers. See **5. Connecting ControlCenter, AmpLink & Serial Control Devices** (page 18) for more information.
- 3 **Serial number.**
- 4 **RS-232 port:** Five-wire, RS-232 (DTE) serial interface connection.
- 5 **Power input:** Power cord connection (IEC 60320-C14 inlet).
- 6 **Network port:** Ethernet network connection for up to 15 ControlCenter interfaces. See **5. Connecting ControlCenter, AmpLink & Serial Control Devices** (page 18) for more information.
- 7 **CC-16 connector:** RS-485 network connection for up to 15 CC-16 zone controllers. See **5. Connecting ControlCenter, AmpLink & Serial Control Devices** (page 18) for more information.
- 8 **Control Inputs & Outputs:** Five inputs and five outputs for general-purpose control. See **7. Connecting GPIO Devices** (page 20) for more information.

ESP-880AD

Front Panel

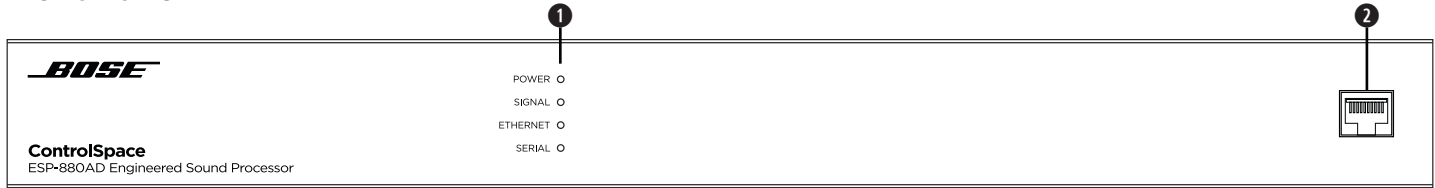

1 LED Indicators:

Power:	Power or fault state indication.	Green:	Power on, normal operation
		Yellow:	Powering on
		Red:	Error (see Troubleshooting on page 22)
Signal:	Signal status indication of all audio input and output channels in order of signaling priority. For precise metering and gain control, connect using ControlSpace Designer software.	Green:	Signal present (-60 dBFS to -20 dBFS)
		Yellow:	Signal level optimal (-20 dBFS to -2 dBFS)
		Red:	Clipping (-2 dBFS to 0 dBFS)
Ethernet:	Connection status indication of Ethernet ports.	Green:	Ethernet link established
		Yellow:	Active transmission/reception
Serial:	Serial command status indication for CC-16 zone controller or RS-232 device.	Green:	CC-16 controller command transmitted
		Yellow:	CC-16 controller command received
		Red:	Active RS-232 transmission/reception

2 Ethernet port: RJ-45 port for front-panel network connectivity. See **8. Connecting to a Network** (page 21) for more information.

Rear Panel

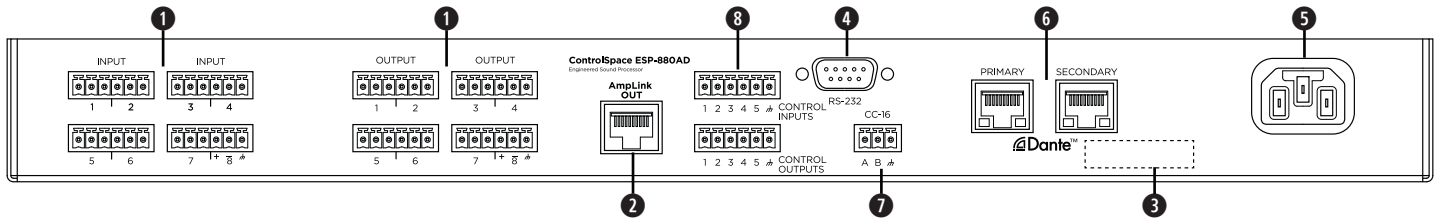

- 1 Audio Inputs & Outputs:** Mic-/line-level inputs and line-level outputs balanced analog audio signals. See **4. Connecting Analog Audio Devices** (page 18) for more information.
- 2 AmpLink Out port:** Ethernet connection for use with AmpLink-equipped PowerMatch amplifiers. See **5. Connecting ControlCenter, AmpLink & Serial Control Devices** (page 19) for more information.
- 3 Serial number.**
- 4 RS-232 port:** Five-wire, RS-232 (DTE) serial interface connection.
- 5 Power input:** Power cord connection (IEC 60320-C14 inlet).
- 6 Dante ports (Primary & Secondary):** Ethernet ports for connection of Dante devices. See **6. Connecting Dante-compatible Devices** (page 19) for more information.
- 7 CC-16 connector:** RS-485 network connection for up to 15 CC-16 zone controllers. See **5. Connecting ControlCenter, AmpLink & Serial Control Devices** (page 19) for more information.
- 8 Control Inputs & Outputs:** Five inputs and five outputs for general-purpose control. See **7. Connecting GPIO Devices** (page 20) for more information.

ESP-1240A

Front Panel

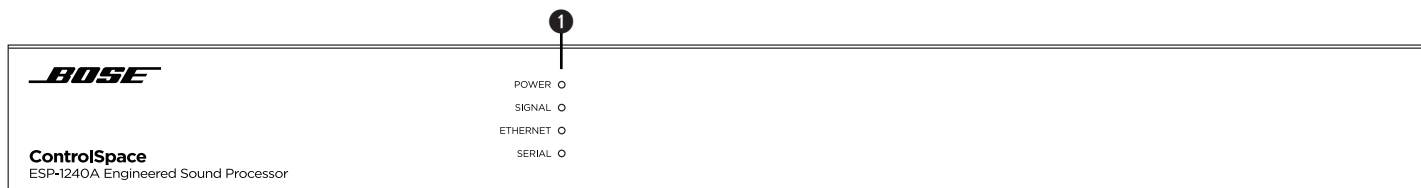

1 LED Indicators:

Power:	Power or fault state indication.	Green: Power on, normal operation Yellow: Powering on Red: Error (see Troubleshooting on page 22)
Signal:	Signal status indication of all audio input and output channels in order of signaling priority. For precise metering and gain control, connect using ControlSpace Designer software.	Green: Signal present (-60 dBFS to -20 dBFS) Yellow: Signal level optimal (-20 dBFS to -2 dBFS) Red: Clipping (-2 dBFS to 0 dBFS)
Ethernet:	Connection status indication of Ethernet ports.	Green: Ethernet link established Yellow: Active transmission/reception
Serial:	Serial command status indication for CC-16 zone controller or RS-232 device.	Green: CC-16 controller command transmitted Yellow: CC-16 controller command received Red: Active RS-232 transmission/reception

Rear Panel

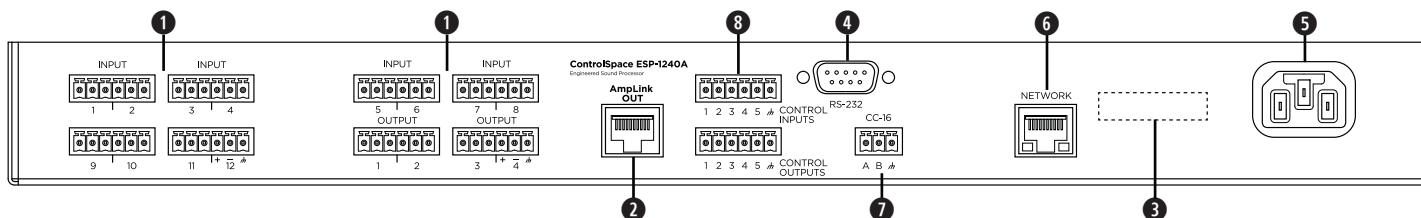

- 1 **Audio Inputs & Outputs:** Mic-/line-level inputs and line-level outputs balanced analog audio signals. See **4. Connecting Analog Audio Devices** (page 18) for more information.
- 2 **AmpLink Out port:** Ethernet connection for use with AmpLink-equipped PowerMatch amplifiers. See **5. Connecting ControlCenter, AmpLink & Serial Control Devices** (page 19) for more information.
- 3 **Serial number.**
- 4 **RS-232 port:** Five-wire, RS-232 (DTE) serial interface connection.
- 5 **Power input:** Power cord connection (IEC 60320-C14 inlet).
- 6 **Network port:** Ethernet network connection for up to 15 ControlCenter interfaces. See **5. Connecting ControlCenter, AmpLink & Serial Control Devices** (page 19) for more information.
- 7 **CC-16 connector:** RS-485 network connection for up to 15 CC-16 zone controllers. See **5. Connecting ControlCenter, AmpLink & Serial Control Devices** (page 19) for more information.
- 8 **Control Inputs & Outputs:** Five inputs and five outputs for general-purpose control. See **7. Connecting GPIO Devices** (page 20) for more information.

ESP-1240AD

Front Panel

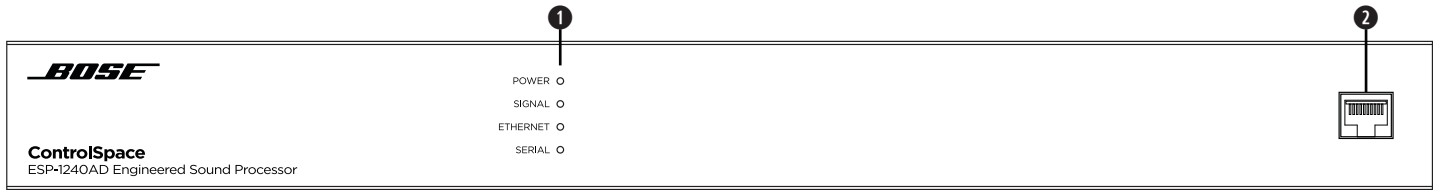

1 LED Indicators:

Power:	Power or fault state indication.	Green: Power on, normal operation Yellow: Powering on Red: Error (see Troubleshooting on page 22)
Signal:	Signal status indication of all audio input and output channels in order of signaling priority. For precise metering and gain control, connect using ControlSpace Designer software.	Green: Signal present (-60 dBFS to -20 dBFS) Yellow: Signal level optimal (-20 dBFS to -2 dBFS) Red: Clipping (-2 dBFS to 0 dBFS)
Ethernet:	Connection status indication of Ethernet ports.	Green: Ethernet link established Yellow: Active transmission/reception
Serial:	Serial command status indication for CC-16 zone controller or RS-232 device.	Green: CC-16 controller command transmitted Yellow: CC-16 controller command received Red: Active RS-232 transmission/reception

2 Ethernet port: RJ-45 port for front-panel network connectivity. See **8. Connecting to a Network** (page 21) for more information.

Rear Panel

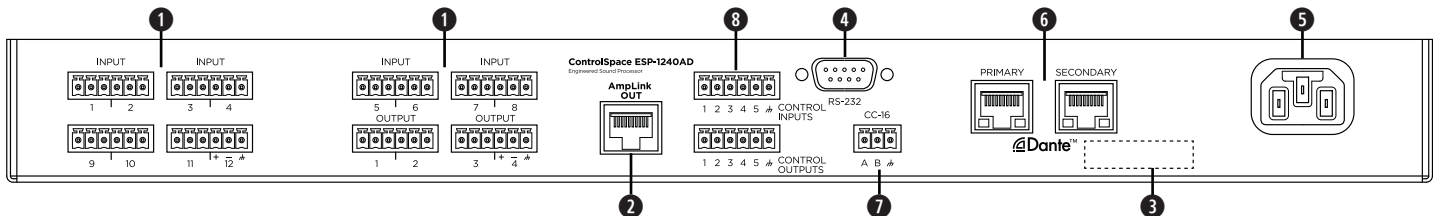

- 1 Audio Inputs & Outputs:** Mic-/line-level inputs and line-level outputs balanced analog audio signals. See **4. Connecting Analog Audio Devices** (page 18) for more information.
- 2 AmpLink Out port:** Ethernet connection for use with AmpLink-equipped PowerMatch amplifiers. See **5. Connecting ControlCenter, AmpLink & Serial Control Devices** (page 19) for more information.
- 3 Serial number.**
- 4 RS-232 port:** Five-wire, RS-232 (DTE) serial interface connection.
- 5 Power input:** Power cord connection (IEC 60320-C14 inlet).
- 6 Dante ports (Primary & Secondary):** Ethernet ports for connection of Dante devices. See **6. Connecting Dante-compatible Devices** (page 19) for more information.
- 7 CC-16 connector:** RS-485 network connection for up to 15 CC-16 zone controllers. See **5. Connecting ControlCenter, AmpLink & Serial Control Devices** (page 19) for more information.
- 8 Control Inputs & Outputs:** Five inputs and five outputs for general-purpose control. See **7. Connecting GPIO Devices** (page 20) for more information.

Hardware Installation

Follow the steps below when setting up a ControlSpace ESP-880A, ESP-880AD, ESP-1240A, or ESP-1240AD engineered sound processor for the first time. See the following sections for additional information about each step.

1. Download and install the latest version of the ControlSpace Designer software.
2. Unpack the processor and other included items.
3. Rack-mount the processor.
4. Connect analog audio devices.
5. Connect all ControlCenter, AmpLink and/or serial control devices.
6. If you are using an ESP-880AD or ESP-1240AD, connect any Dante network devices.
7. Connect GPIO devices.
8. Connect the system to a network.
9. Use the included power cord to connect the processor to a power outlet.
10. Configure the processor using ControlSpace Designer software.

1. Downloading & Installing ControlSpace Designer

Before working with the ControlSpace processor, visit pro.Bose.com to download the latest version of the ControlSpace Designer software and install it. The download includes product firmware, the latest algorithms, and a detailed help system that guides system designers and installers through configuring the processor for use in high-quality audio systems.

2. Unpacking the Carton

The product carton includes the following items. Inspect all components for shipping damage and contact your Bose Professional representative if you find any issues.

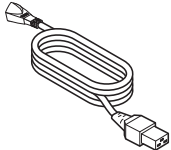
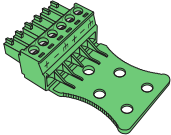
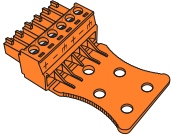
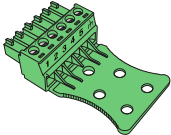
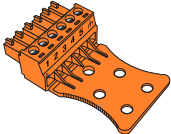
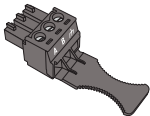
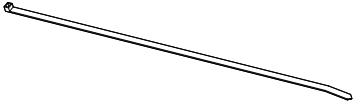
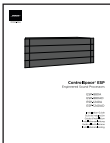
Item	ESP-880A	ESP-880AD	ESP-1240A	ESP-1240AD
 ControlSpace processor	1	1	1	1
 Power cord	1	1	1	1
 Euroblock connector (green, 6 pins, analog audio input)	4	4	6	6
 Euroblock connector (orange, 6 pins, analog audio output)	4	4	2	2
 Euroblock connector (green, 6 pins, control input)	1	1	1	1
 Euroblock connector (orange, 6 pins, control output)	1	1	1	1
 Euroblock connector (black, 3 pins, CC-16)	1	1	1	1
 Cable ties	11	11	11	11
 Installation guide	1	1	1	1

3. Rack-mounting the Processor

ESP-880A, ESP-880AD, ESP-1240A, and ESP-1240AD processors fit standard 19-inch (48-centimeter) rack equipment, occupying one rack unit (1 RU) in height and requiring a mounting depth of 8.2 inches (208 millimeters) from the front rack rail. Use four fasteners with washers (not included) to mount the processor.

This product uses active side ventilation and can safely operate in ambient conditions from 32 °F to 104 °F (0 °C to 40 °C).

See **Technical Specifications** (page 24) for power dissipation ratings for each model.

4. Connecting Analog Audio Devices

The processor includes balanced dual-channel (six-terminal) Euroblock connectors for analog audio devices. The termination end of each connector includes printed terminal block descriptions. The following diagrams show the recommended balanced/unbalanced wiring between the audio connectors on the processor and common audio connectors to external audio components.

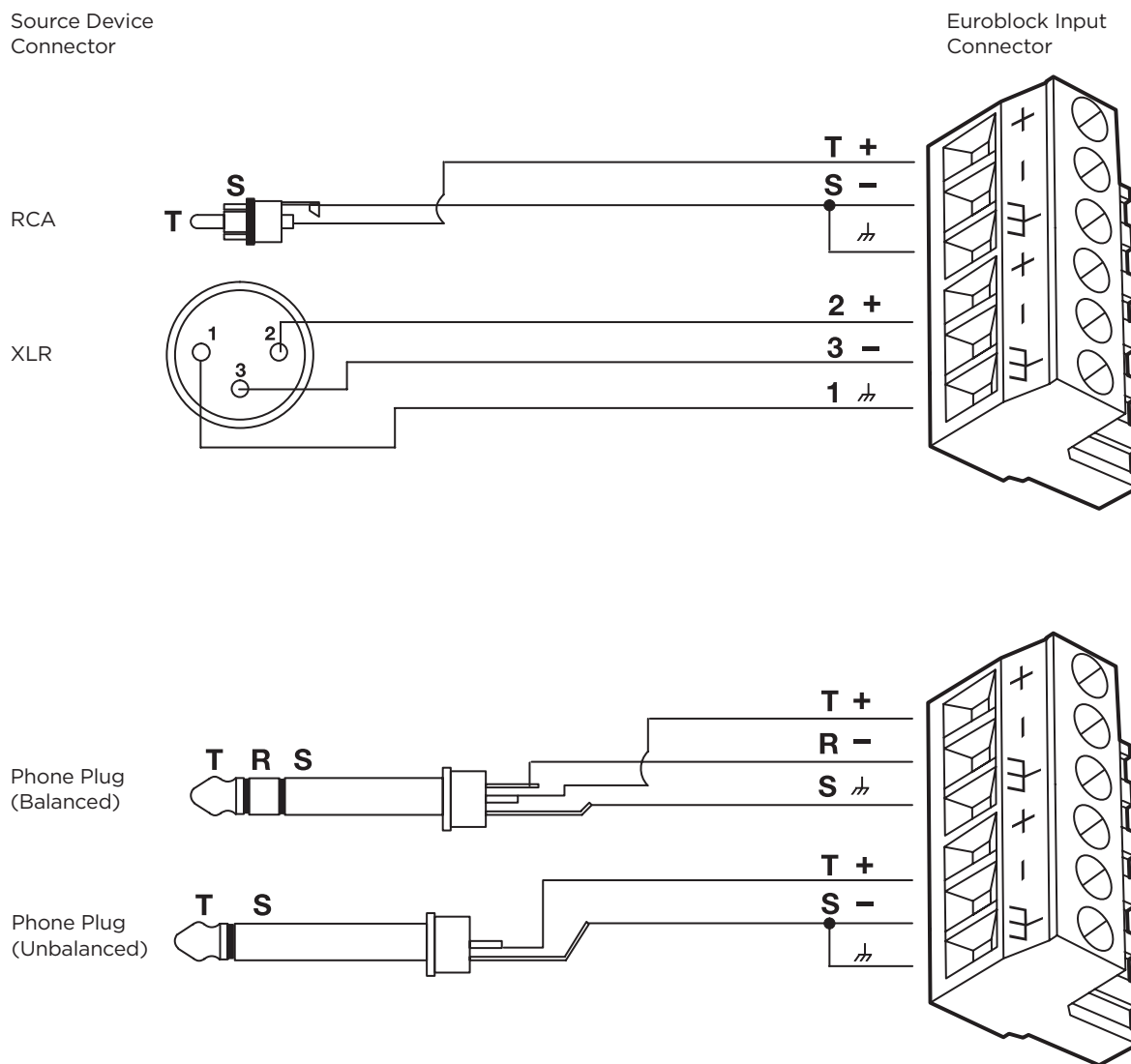

5. Connecting ControlCenter, AmpLink & Serial Control Devices

CC-16 Connector

The CC-16 connector is an RS-485 network connection for use with Bose CC-16 zone controllers. Using the included 3-pin Euroblock connector, you can network up to 15 CC-16 zone controllers to control the ESP-880A, ESP-880AD, ESP-1240A, or ESP-1240AD processor or any device on the Bose ControlSpace control network. An external power supply is required.

In addition to wiring the A and B terminals, we highly recommended connecting the ground terminal from the processor to each CC-16 zone controller. The maximum distance from processor to any CC-16 is 2,000 feet (610 meters).

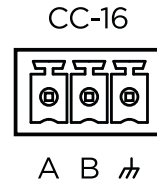

AmpLink Connector

The AmpLink connector provides a low-latency method for transporting up to eight channels of uncompressed audio to PowerMatch amplifiers (with an AmpLink 24-channel input card installed). Use standard Ethernet cables to make these connections.

ESP-880A, ESP-880AD, ESP-1240A, and ESP-1240AD processors can also serve as centralized input-routing/mixing points for simplified audio distribution to one or more PowerMatch amplifiers when installed in the same rack. Additionally, each PowerMatch amplifier must have an AmpLink 24-channel input card installed in its rear panel. Use an Ethernet cable to connect your processor's **AmpLink Out** port to the **Input** port of the input card. To connect additional PowerMatch amplifiers, use an Ethernet cable to connect the **Thru** port of each input card to the **Input** port of the input card of the next amplifier.

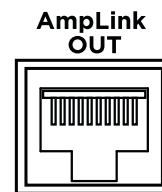

RS-232 Connector (Serial Control)

The RS-232 connector provides a DB-9 male connector (type DTE) for communication between the ESP-880A, ESP-880AD, ESP-1240A, or ESP-1240AD processor and other serial-controlled devices including third-party control systems.

The default serial port settings are 115,200 baud, 8-bits length, 1 stop bit, no parity, and no flow control. If required these settings can be changed using ControlSpace Designer software.

The document ControlSpace Serial Control Protocol (which you can download from pro.Bose.com) outlines all supported command strings and functions available to control and query the ESP-880A, ESP-880AD, ESP-1240A, and ESP-1240AD processors.

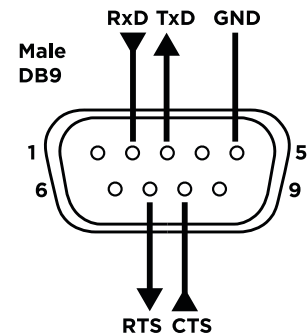

6. Connecting Dante-compatible Devices

The ESP-880AD and ESP-1240AD feature **Primary** and **Secondary** Dante network ports, which provide 32 input channels and 32 output channels of low-latency digital audio using Dante audio networking. These ports can be configured for switched (default), redundant, isolated, or filtered network connections for legacy products. You can daisy-chain up to 10 devices using the switched port configuration.

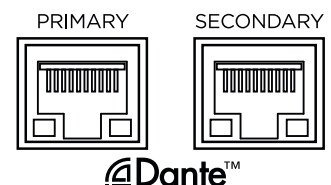

7. Connecting GPIO Devices

You can use the five control inputs (GPI) and five controls outputs (GPO) to interface the processor with external control hardware.

General Purpose Inputs

You can connect general-purpose control inputs to external hardware such as switches (to invoke parameter sets) or potentiometers (to control levels or gains). Using ControlSpace Designer software, you can easily assign functions to these external controls. In addition, Bose offers several GPI-compatible interfaces (see **Available Accessories** on page 11 for a complete list).

Using Switches

You can use toggle switches or pushbuttons with control inputs. Each input terminal is tied to an internal two-kiloohm pull-up resistor so that external switches can be wired directly from input to ground.

Example: GPI connections for switches

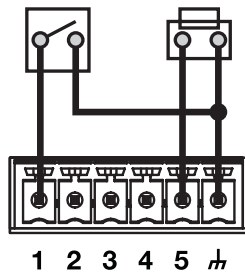

Using Potentiometers

You can use 10-kiloohm potentiometers with control gain blocks in a system design. Inputs are compatible (through ControlSpace Designer software) with linear taper potentiometers wired for minimum resistance at the full-clockwise position or at the full-counterclockwise position.

Example: GPI connections for a potentiometer

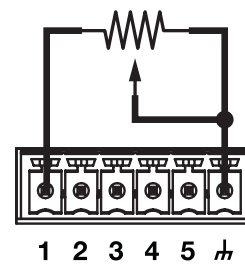

General Purpose Outputs

Current Source Devices

The control outputs can power some devices such as LEDs and low-current relays directly. The maximum source current is 10 milliamps.

Source Limits: 8 VDC, 10 mA (maximum).

Example: GPO connections for a current source

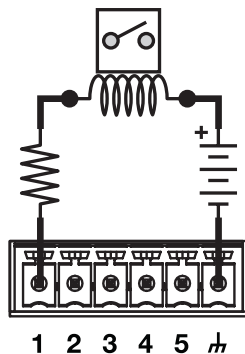

Current Sink Devices

Devices that require more current than is available from a current-source configuration can use control outputs to sink up to 100 milliamps when used with external power supplies. Use proper precautions when driving inductive loads.

Sink Limits: 100 mA (maximum). External supplies must be ≤ 24 VDC.

Example: GPO connections for a current sink

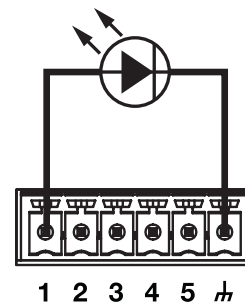

8. Connecting to a Network

The ESP-880A and ESP-1240A include an RJ-45 **Ethernet** port on the rear panel for network connection.

The ESP-880AD and ESP-1240AD include an unlabeled RJ-45 port on the front panel for network connection.

Use a foiled or unshielded twisted-pair (F/UTP) Cat 5e cable (not included) to connect this port on each processor to your network or computer. Make this connection directly to the processor or through a switched Ethernet network.

Note: All fixed-I/O processors are set to **DHCP** which you can change using ControlSpace Designer software.

For more information, see the ControlSpace Designer software help file at **pro.Bose.com** or in the installed software.

NETWORK

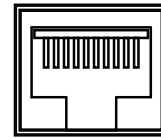
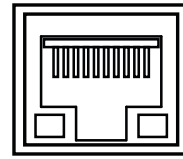

9. Connecting to Power

The ESP-880A, ESP-880AD, ESP-1240A, and ESP-1240AD can operate with AC mains line voltages from 85 volts to 264 volts at 50 Hz/60 Hz over a detachable IEC power cord. Power consumption is 37 volt-amperes at an ambient temperature of 104 °F (40 °C).

To power on the processor, use the included power cord to connect the processor's **power inlet** to a power outlet. After powering on, the boot time may be as long as 40 seconds. The processor is fully operable when the **Power** LED on the front panel is lit solid green.

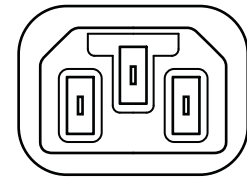

POWER ○

10. Configuring the Processor with ControlSpace Designer

While the ESP-880A, ESP-880AD, ESP-1240A, or ESP-1240AD is connected to a network with your computer, use the **Update Firmware** function in ControlSpace Designer to scan and update the processor's firmware. Once the processor is using the latest firmware, proceed with your system design in ControlSpace Designer.

For more information on using the ControlSpace Designer software, see its help file at **pro.Bose.com** or in the installed software itself. You can use ControlSpace Designer to configure, control, and monitor the ESP-880A, ESP-880AD, ESP-1240A, and ESP-1240AD as well as entire systems built with Bose networked system electronics.

Maintenance Operations

Firmware & Software Upgrades

Bose periodically releases updates for the processor firmware as well as the ControlSpace Designer software. Please visit pro.Bose.com regularly to check for updates.

Battery Replacement

The ESP-880A, ESP-880AD, ESP-1240A, and ESP-1240AD each contain a replaceable lithium battery for maintaining the real-time clock (RTC) capability of the system. This battery lasts at least 10 years from the time of production and rarely requires replacement.

Troubleshooting

The Power LED on front panel is not lit solid green.	Use the included power cord to connect the processor's power inlet (on the rear panel) to a power outlet. Make sure that the mains power is active.
The power is on, but there is no sound.	Use the ControlSpace Designer software to make sure that there is an input signal from the source. The audio signal level should be in the green or yellow band of the meter. Use the ControlSpace Designer software to make sure that there is an output signal from the processor. The audio signal level should be in the green or yellow band of the meter.
The sound is distorted.	Using the ControlSpace Designer software, check the audio input signal indicators. If the indicators are solid red or flashing red, reduce the input pre-gain setting until the signal is no longer clipping (red). Using the ControlSpace Designer software, check the audio output signal indicators. If the indicators are solid red or flashing red, and if the input indicators are green, use the software to reduce the output gain or any intermediary gain in the signal path. If the input and output indicators are green, and if the input signal is undistorted when it enters the processor, make sure that the loudspeakers are not being overdriven and are not damaged.
The Power LED is red.	The DSP configuration is not loaded. Use the ControlSpace Designer software to load a DSP configuration. Disconnect the power cord from the power outlet, and then reconnect it. If the issue continues, call your Bose Professional sales/support representative.

The **Ethernet** LED is off.

Make sure that the processor's network port is securely connected to a computer, hub, or switch using a foiled or unshielded twisted-pair (F/UTP) Cat 5e cable (not included).

On the ESP-880A and ESP-1240A, this is the RJ-45 **Ethernet** port on the rear panel.

On the ESP-880AD and ESP-1240AD, this is the unlabeled RJ-45 port on the front panel.

Make sure that the computer's Ethernet connection is enabled. If it is disabled, the Link LED on the computer will probably be off.

If the processor is connected to a hub or switch, make sure the Link LED on the hub or switch is on.

The **Ethernet** LED is on but cannot communicate with processor.

If you recently connected the processor to a power outlet, wait 40 seconds to make sure that the processor is fully booted. The **Power** LED should be a solid green color.

Make sure that the network settings on the TCP/IP Ethernet device you are using on the computer are set correctly:

If you are not using a DHCP server, manually set the computer's IP address to an unused IP address (e.g. 192.168.0.2).

The default IP subnet mask should be set to **255.255.255.0**.

Open the firewall settings on the computer, and unblock all ports.

In the ControlSpace Designer software, make sure that the proper network interface card (NIC) is selected.

If you are using an ESP-880AD or ESP-1240AD, make sure that the front-panel and rear-panel Ethernet ports are not connected to the same network.

Make sure that there is not another processor connected with the same address. If you are not sure, disconnect a processor, scan for the other processor, and then change its address. Repeat with the second processor.

Technical Specifications

ESP-880A

Integrated DSP

Signal Processor	32-bit fixed-/floating-point DSP with Arm® processor, 456 MHz
Maximum Calculation	3.6 GIPS / 2.7 GFLOPS
Delay	43 s
Audio Latency	860 μs (analog in to analog out)
A/D & D/A Converters	24-bit
Sampling Rate	48 kHz

Audio Performance

Frequency Response	20 Hz–20 kHz (+0.3 dB/–0.1 dB)
THD+N	0.002% at +4 dBu (A-weighted, 20 Hz–20 kHz)
Channel Separation (Crosstalk)	< –105 dB at +4 dBu input & output level, 1 kHz
Dynamic Range	> 115 dB (A-weighted, 20 Hz–20 kHz, analog through)

Audio Inputs

Input Channels	8 analog (balanced, mic-/line-level)
Input Connectors	Euroblock (6 pins, 3.81 mm)
Input Impedance	12 kΩ at 1 kHz (with or without phantom power active)
Maximum Input Level	+24 dBu
Equivalent Input Noise	< –119 dBu (22 Hz–20 kHz, 150 Ω input, 64 dB gain)
Phantom Power	+48 VDC, 10 mA, selectable per input
Gain Settings	0, 14, 24, 32, 44, 54 & 64 dB

Audio Outputs

Output Channels	8 analog (balanced, line-level), 8 AmpLink
Output Connectors	Euroblock (6 pins, 3.81 mm), RJ-45 (AmpLink)
Output Impedance	66 Ω
Maximum Output Level	+24 dBu

Control Inputs

Inputs (Control)	5 analog or digital inputs, internal 2 kΩ pull-up resistor to 5 V, Euroblock connector (6 pins, 3.81 mm)
Analog Input Voltage Range	0 V–3.3 V (5 V maximum)
Digital Input Voltage Range	0 V–3.3 V (1.6 V threshold voltage)

Control Outputs

Outputs (Control)	5 digital outputs, Euroblock connector (6 pins, 3.81 mm)
Output Voltage	High: 8 V (open circuit), 2.5 V at 10 mA Low: < 1 V at 100 mA, push-pull
Output Current	10 mA source, 100 mA sink (24 VDC maximum external supply voltage)

Indicators & Controls

Status LEDs	Power/Status, Signal, Ethernet, Serial (RS-232 & CC-16)
Audio Signal	Green (-60 dBFS to -20 dBFS), yellow (-20 dBFS to -2 dBFS), red (-2 dBFS to 0 dBFS)

Electrical

Mains Voltage	85 VAC-264 VAC, 50 Hz/60 Hz
AC Power Consumption	< 37 VA typical, over all mains voltages
Mains Connector	IEC 60320-C14 inlet
Power Dissipation	22 W, 75 BTU/hr (19 kcal/hr)

Physical

Dimensions (H × W × D)	1.7 in × 19.0 in × 8.5 in (44 mm × 483 mm × 215 mm)
Net Weight	5.7 lb (2.6 kg)
Operating Temperature	32 °F to 104 °F (0 °C to 40 °C)
Cooling System	Active, side-venting

General

Configuration Software	ControlSpace Designer software on Windows® computer
Network Control	Ethernet (RJ-45), 100 Mb
Communication Ports	RS-232 (DB9M, DTE), Bose CC-16 (Euroblock connector, 3 pins, 3.81 mm)

ESP-880AD

Integrated DSP

Signal Processor	32-bit fixed-/floating-point DSP with Arm processor, 456 MHz
Maximum Calculation	3.6 GIPS / 2.7 GFLOPS
Delay	43 s
Audio Latency	860 μ s (analog in to analog out)
A/D & D/A Converters	24-bit
Sampling Rate	48 kHz

Audio Performance

Frequency Response	20 Hz–20 kHz (+0.3 dB/–0.1 dB)
THD+N	0.002% at +4 dBu (A-weighted, 20 Hz–20 kHz)
Channel Separation (Crosstalk)	< –105 dB at +4 dBu input & output level, 1 kHz
Dynamic Range	> 115 dB (A-weighted, 20 Hz–20 kHz, analog through)

Audio Inputs

Input Channels	8 analog (balanced, mic-/line-level), 32 digital (Dante)
Input Connectors	Euroblock (6 pins, 3.81 mm)
Input Impedance	12 k Ω at 1 kHz (with or without phantom power active)
Maximum Input Level	+24 dBu
Equivalent Input Noise	< –119 dBu (22 Hz–20 kHz, 150 Ω input, 64 dB gain)
Phantom Power	+48 VDC, 10 mA, selectable per input
Gain Settings	0, 14, 24, 32, 44, 54 & 64 dB

Audio Outputs

Output Channels	8 analog (balanced, line-level), 40 digital (8 AmpLink & 32 Dante)
Output Connectors	Euroblock (6 pins, 3.81 mm), RJ-45 (AmpLink & Dante)
Output Impedance	66 Ω
Maximum Output Level	+24 dBu

Control Inputs

Inputs (Control)	5 analog or digital inputs, internal 2 k Ω pull-up resistor to 5 V, Euroblock connector (6 pins, 3.81 mm)
Analog Input Voltage Range	0 V–3.3 V (5 V maximum)
Digital Input Voltage Range	0 V–3.3 V (1.6 V threshold voltage)

Control Outputs

Outputs (Control)	5 digital outputs, Euroblock connector (6 pins, 3.81 mm)
Output Voltage	High: 8 V (open circuit), 2.5 V at 10 mA Low: < 1 V at 100 mA, push-pull
Output Current	10 mA source, 100 mA sink (24 VDC maximum external supply voltage)

Indicators & Controls

Status LEDs	Power/Status, Signal, Ethernet, Serial (RS-232 & CC-16)
Audio Signal	Green (-60 dBFS to -20 dBFS), yellow (-20 dBFS to -2 dBFS), red (-2 dBFS to 0 dBFS)

Electrical

Mains Voltage	85 VAC-264 VAC, 50 Hz/60 Hz
AC Power Consumption	< 37 VA typical, over all mains voltages
Mains Connector	IEC 60320-C14 inlet
Power Dissipation	22 W, 75 BTU/hr (19 kcal/hr)

Physical

Dimensions (H x W x D)	1.7 in x 19.0 in x 8.5 in (44 mm x 483 mm x 215 mm)
Net Weight	5.9 lb (2.7 kg)
Operating Temperature	32 °F to 104 °F (0 °C to 40 °C)
Cooling System	Active, side-venting

General

Configuration Software	ControlSpace Designer software on Windows® computer
Network Control	Ethernet (RJ-45), 100 Mb
Communication Ports	RS-232 (DB9M, DTE), Bose CC-16 (Euroblock connector, 3 pins, 3.81 mm)

ESP-1240A

Integrated DSP

Signal Processor	32-bit fixed-/floating-point DSP with Arm processor, 456 MHz
Maximum Calculation	3.6 GIPS / 2.7 GFLOPS
Delay	43 s
Audio Latency	860 μ s (analog in to analog out)
A/D & D/A Converters	24-bit
Sampling Rate	48 kHz

Audio Performance

Frequency Response	20 Hz–20 kHz (+0.3 dB/–0.1 dB)
THD+N	0.002% at +4 dBu (A-weighted, 20 Hz–20 kHz)
Channel Separation (Crosstalk)	< –105 dB at +4 dBu input & output level, 1 kHz
Dynamic Range	> 115 dB (A-weighted, 20 Hz–20 kHz, analog through)

Audio Inputs

Input Channels	12 analog (balanced, mic-/line-level)
Input Connectors	Euroblock (6 pins, 3.81 mm)
Input Impedance	12 k Ω at 1 kHz (with or without phantom power active)
Maximum Input Level	+24 dBu
Equivalent Input Noise	< –119 dBu (22 Hz–20 kHz, 150 Ω input, 64 dB gain)
Phantom Power	+48 VDC, 10 mA, selectable per input
Gain Settings	0, 14, 24, 32, 44, 54 & 64 dB

Audio Outputs

Output Channels	4 analog (balanced, line-level), 8 digital (AmpLink)
Output Connectors	Euroblock (6 pins, 3.81 mm), RJ-45 (AmpLink)
Output Impedance	66 Ω
Maximum Output Level	+24 dBu

Control Inputs

Inputs (Control)	5 analog or digital inputs, internal 2 k Ω pull-up resistor to 5 V, Euroblock connector (6 pins, 3.81 mm)
Analog Input Voltage Range	0 V–3.3 V (5 V maximum)
Digital Input Voltage Range	0 V–3.3 V (1.6 V threshold voltage)

Control Outputs

Outputs (Control)	5 digital outputs, Euroblock connector (6 pins, 3.81 mm)
Output Voltage	High: 8 V (open circuit), 2.5 V at 10 mA Low: < 1 V at 100 mA, push-pull
Output Current	10 mA source, 100 mA sink (24 VDC maximum external supply voltage)

Indicators & Controls

Status LEDs	Power/Status, Signal, Ethernet, Serial (RS-232 & CC-16)
Audio Signal	Green (-60 dBFS to -20 dBFS), yellow (-20 dBFS to -2 dBFS), red (-2 dBFS to 0 dBFS)

Electrical

Mains Voltage	85 VAC-264 VAC, 50 Hz/60 Hz
AC Power Consumption	< 37 VA typical, over all mains voltages
Mains Connector	IEC 60320-C14 inlet
Power Dissipation	22 W, 75 BTU/hr (19 kcal/hr)

Physical

Dimensions (H × W × D)	1.7 in × 19.0 in × 8.5 in (44 mm × 483 mm × 215 mm)
Net Weight	5.7 lb (2.6 kg)
Operating Temperature	32 °F to 104 °F (0 °C to 40 °C)
Cooling System	Active, side-venting

General

Configuration Software	ControlSpace Designer software on Windows® computer
Network Control	Ethernet (RJ-45), 100 Mb
Communication Ports	RS-232 (DB9M, DTE), Bose CC-16 (Euroblock connector, 3 pins, 3.81 mm)

ESP-1240AD

Integrated DSP

Signal Processor	32-bit fixed-/floating-point DSP with Arm processor, 456 MHz
Maximum Calculation	3.6 GIPS / 2.7 GFLOPS
Delay	43 s
Audio Latency	860 μ s (analog in to analog out)
A/D & D/A Converters	24-bit
Sampling Rate	48 kHz

Audio Performance

Frequency Response	20 Hz–20 kHz (+0.3 dB/–0.1 dB)
THD+N	0.002% at +4 dBu (A-weighted, 20 Hz–20 kHz)
Channel Separation (Crosstalk)	< –105 dB at +4 dBu input & output level, 1 kHz
Dynamic Range	> 115 dB (A-weighted, 20 Hz–20 kHz, analog through)

Audio Inputs

Input Channels	8 analog (balanced, mic-/line-level), 32 digital (Dante)
Input Connectors	Euroblock (6 pins, 3.81 mm)
Input Impedance	12 k Ω at 1 kHz (with or without phantom power active)
Maximum Input Level	+24 dBu
Equivalent Input Noise	< –119 dBu (22 Hz–20 kHz, 150 Ω input, 64 dB gain)
Phantom Power	+48 VDC, 10 mA, selectable per input
Gain Settings	0, 14, 24, 32, 44, 54 & 64 dB

Audio Outputs

Output Channels	4 analog (balanced, line-level), 40 digital (8 AmpLink & 32 Dante)
Output Connectors	Euroblock (6 pins, 3.81 mm), RJ-45 (AmpLink & Dante)
Output Impedance	66 Ω
Maximum Output Level	+24 dBu

Control Inputs

Inputs (Control)	5 analog or digital inputs, internal 2 k Ω pull-up resistor to 5 V, Euroblock connector (6 pins, 3.81 mm)
Analog Input Voltage Range	0 V–3.3 V (5 V maximum)
Digital Input Voltage Range	0 V–3.3 V (1.6 V threshold voltage)

Control Outputs

Outputs (Control)	5 digital outputs, Euroblock connector (6 pins, 3.81 mm)
Output Voltage	High: 8 V (open circuit), 2.5 V at 10 mA Low: < 1 V at 100 mA, push-pull
Output Current	10 mA source, 100 mA sink (24 VDC maximum external supply voltage)

Indicators & Controls

Status LEDs	Power/Status, Signal, Ethernet, Serial (RS-232 & CC-16)
Audio Signal	Green (–60 dBFS to –20 dBFS), yellow (–20 dBFS to –2 dBFS), red (–2 dBFS to 0 dBFS)

Electrical

Mains Voltage	85 VAC–264 VAC, 50 Hz/60 Hz
AC Power Consumption	< 37 VA typical, over all mains voltages
Mains Connector	IEC 60320-C14 inlet
Power Dissipation	22 W, 75 BTU/hr (19 kcal/hr)

Physical

Dimensions (H × W × D)	1.7 in × 19.0 in × 8.5 in (44 mm × 483 mm × 215 mm)
Net Weight	5.9 lb (2.7 kg)
Operating Temperature	32 °F to 104 °F (0 °C to 40 °C)
Cooling System	Active, side-venting

General

Configuration Software	ControlSpace Designer software on Windows® computer
Network Control	Ethernet (RJ-45), 100 Mb
Communication Ports	RS-232 (DB9M, DTE), Bose CC-16 (Euroblock connector, 3 pins, 3.81 mm)

Software License Disclosure

To view the third-party software license disclosure for the processor:

1. At a DOS prompt, type **ftp 123.456.7.890<ret>**, but enter the actual processor IP address instead of **123.456.7.890**.
2. At the **User (123.456.7.890:(none)):** prompt, type **ftp<ret>** (the actual processor IP address you entered will be shown instead of **123.456.7.890**).
3. At the **Password** prompt, type **<ret>**.
4. At the **ftp>** prompt, type **get license.txt**.
5. After the transfer is complete, type **quit**.
6. Find the **license.txt** file in the default **cmd** directory.



372643-0010

©2018 Bose Corporation, All rights reserved.
Framingham, MA 01701-9168 USA
PRO.BOSE.COM
All trademarks are the property of their respective owners
AM372643 Rev. 03
July 2018

