



CC-1
CC-2
CC-3

ControlCenter Zone Controllers

Installation and Operation Guide
Guía de Instalación y Funcionamiento
Guide d'installation et utilisation
Installations- und Bedienungsanleitung
Manuale di installazione e funzionamento
Installatie- en bedieningshandleiding

Please read this owner's guide carefully and save it for future reference.

This product is intended for installation by professional installers only! This document is intended to provide professional installers with basic installation and safety guidelines for this product in typical fixed-installation systems. Please read this document before attempting installation.

WARNING:

- All Bose products must be installed in accordance with local, state, federal and industry regulations. It is the installer's responsibility to ensure installation of the loudspeakers and mounting system is performed in accordance with all applicable codes, including local building codes and regulations. Consult the local authority having jurisdiction before installing this product.
- To reduce the risk of fire or electrical shock, do not expose the product to rain or moisture.
- Do not expose this apparatus to dripping or splashing, and do not place objects filled with liquids such as vases, on or near the apparatus. Exposure to liquid may create a fire hazard.
- Do not place any naked flame sources, such as lighted candles, on or near the apparatus.
- This product is not intended for installation or use in indoor water facility areas (including, without limitation, indoor pools, indoor water parks, hot tub rooms, saunas, steam rooms and indoor skating rinks).



Contains small parts which may be a choking hazard. Not suitable for children under age 3.

CAUTION:

- Do not make unauthorized alterations to the product; doing so may compromise safety, regulatory compliance, system performance, and may void the warranty.



The exclamation point within an equilateral triangle, as marked on the system, is intended to alert the user to the presence of important operating and maintenance instructions in this installation guide.

1. Read these instructions.
2. Keep these instructions.
3. Heed all warnings.
4. Follow all instructions.
5. Do not use this apparatus near water.
6. Clean only with a dry cloth.
7. Do not block any ventilation openings. Install in accordance with the manufacturer's instructions.
8. Do not install near any heat sources, such as radiators, heat registers, stoves or other apparatus (including amplifiers) that produce heat.
9. Only use attachments/accessories specified by the manufacturer.
10. Refer all servicing to qualified personnel. Servicing is required when the apparatus has been damaged in any way, such as power-supply cord or plug is damaged, liquid has been spilled or objects have fallen into the apparatus, the apparatus has been exposed to rain or moisture, does not operate normally, or has been dropped.



This product conforms to all applicable EU directive requirements. The complete Declaration of Conformity can be found at www.Bose.com/compliance

Lea atentamente esta guía del usuario y guárdela para consultarla en el futuro.

Solo un instalador profesional deberá montar este producto. Este documento está pensado para ofrecer a los instaladores profesionales instrucciones básicas de instalación y seguridad relacionadas con este producto en sistemas típicos de instalaciones fijas. Lea este documento antes de intentar la instalación.

ADVERTENCIA:

- Para reducir el riesgo de incendio o descarga eléctrica, no exponga el producto a lluvia o humedad.
- No exponga este aparato a salpicaduras o goteo. No coloque objetos que contengan líquidos, por ejemplo, jarrones, encima o cerca del aparato. Al igual que con cualquier producto electrónico, evite que se derramen líquidos en los componentes del sistema, ya que pueden provocar averías o riesgo de incendio.
- No coloque llamas vivas, por ejemplo, velas, encima o cerca del aparato.
- This product is not intended for installation or use in indoor water facility areas (including, without limitation, indoor pools, indoor water parks, hot tub rooms, saunas, steam rooms and indoor skating rinks).
- Todos los productos Bose se deben utilizar según lo estipulado en las normativas industriales locales, regionales y nacionales. Será responsabilidad del instalador garantizar que la instalación del amplificador se lleva a cabo según lo dispuesto en los códigos correspondientes, incluidos los códigos de construcción locales y las normativas. Consulte a las autoridades locales pertinentes antes de instalar este producto.



Contiene piezas pequeñas que pueden suponer riesgo de asfixia. No adecuado para niños de menos de 3 años.

PRECAUCIÓN:

- No realice modificaciones al sistema ni a los accesorios. Las alteraciones no autorizadas pueden comprometer la seguridad, el cumplimiento regulatorio y el desempeño del sistema.



El signo de exclamación dentro de un triángulo equilátero, tal como aparece marcado en el sistema, avisa al usuario de que existen instrucciones de operación y mantenimiento importantes en esta guía de instalación.

1. Lea las siguientes instrucciones.
2. Guarde estas instrucciones para consultarlas en el futuro.
3. Respete todas las advertencias que se indican en el producto y en la documentación.
4. Siga todas las instrucciones.
5. No utilice este aparato cerca del agua.
6. Límpielo solo con un trapo seco.
7. No bloquee las aberturas de ventilación. Instálelo siguiendo las instrucciones del fabricante.
8. No lo instale cerca de fuentes de calor, tales como radiadores, salidas de aire caliente, cocinas u otros aparatos (incluidos amplificadores) que generen calor.
9. Utilice solo conexiones y accesorios suministrados por el fabricante.
10. Toda reparación debe ser realizada por personal cualificado. Lleve el dispositivo a reparar si presenta algún daño como, por ejemplo, si el cable de alimentación o el enchufe están dañados, si se han vertido líquidos o se han caído objetos sobre el dispositivo o si éste ha estado expuesto a la lluvia o humedad; si no funciona correctamente o se ha caído al suelo.



Este producto cumple los requisitos de todas las Directivas de la UE aplicables legalmente. Encontrará la declaración de conformidad completa en www.Bose.com/compliance.

Consultez attentivement cette notice d'utilisation et conservez-la pour toute référence future.

L'installation de ce produit est réservée à un technicien professionnel! Ce document à l'intention des installateurs professionnels contient les directives de pose et de sécurité relatives à ce produit en installation fixe. Lisez attentivement ce document avant l'installation.

AVERTISSEMENT:

- Tous les produits Bose doivent être utilisés en respectant les réglementations locales et nationales. L'installateur est responsable du respect de tous les codes et règlements locaux et nationaux en vigueur applicables à l'installation du produit. Consultez les autorités locales compétentes avant d'installer ce produit.
- Pour limiter les risques d'incendie ou d'électrocution, n'exposez pas l'appareil à la pluie ou à l'humidité.
- Protégez l'appareil de tout risque de ruissellement ou d'éclaboussure. Ne placez pas d'objets contenant des liquides, tels que des vases, sur l'appareil. L'exposition aux liquides peut induire un risque d'incendie.
- Ne placez aucune source de flamme nue, comme une bougie allumée, sur ou près de l'appareil.
- Ce produit n'est pas destiné à être monté ou utilisé dans des installations humides en intérieur (par exemple piscine intérieure, parc aquatique intérieur, baignoire à remous, sauna, hammam, patinoire intérieure, etc.).



Certaines pièces présentent un risque de suffocation. Ne pas laisser à la portée des enfants de moins de 3 ans.

ATTENTION:

- Toute modification non autorisée peut compromettre votre sécurité, le respect des réglementations et le bon fonctionnement de l'appareil, et en invalidera la garantie.



Ce symbole signale la présence d'instructions importantes relatives au fonctionnement et à l'entretien de l'appareil dans ce guide.

1. Veuillez lire ces instructions.
2. Veuillez conserver ces instructions.
3. Respectez tous les avertissements.
4. Suivez toutes les instructions.
5. N'utilisez pas cet appareil à proximité d'eau ou d'une source d'humidité.
6. Utilisez uniquement un chiffon sec pour le nettoyage.
7. Ne bloquez jamais les orifices d'aération. Suivez les instructions du fabricant pour l'installation.
8. N'installez pas cet appareil à proximité d'une quelconque source de chaleur, telle qu'un radiateur, une arrivée d'air chaud, un four ou tout autre appareil (notamment des amplificateurs) produisant de la chaleur.
9. Utilisez uniquement les accessoires spécifiés par le fabricant.
10. Confiez toute réparation à du personnel qualifié. Une réparation est nécessaire lorsque l'appareil a été endommagé de quelque façon que ce soit (endommagement du cordon d'alimentation ou de la fiche électrique, renversement d'un liquide ou de tout objet sur l'appareil, exposition de l'appareil à la pluie ou à l'humidité, mauvais fonctionnement, chute de l'appareil, etc.).



Ce produit est conforme à toutes les directives de la Communauté Européenne qui s'y appliquent. L'attestation complète de conformité est disponible à l'adresse www.Bose.com/compliance.

Bitte lesen Sie diese Bedienungsanleitung durch und bewahren Sie sie zum späteren Nachschlagen auf. Dieses Produkt darf nur von fachkundigen Monteuren installiert werden! Dieses Dokument soll fachkundigen Monteuren grundlegende Installations- und Sicherheitsrichtlinien für dieses Produkt in typischen Festinstallationsystemen bieten. Bitte lesen Sie dieses Dokument vor der Installation durch.

WARNHINWEISE:

- Alle Bose-Produkte müssen gemäß den örtlichen und staatlichen Vorschriften sowie gemäß allen Branchenbestimmungen verwendet werden. Der Monteur ist dafür verantwortlich, sicherzustellen, dass die Installation des Produkts gemäß allen geltenden Vorschriften durchgeführt wird, einschließlich örtlicher Bauvorschriften und Bestimmungen. Wenden Sie sich vor der Installation dieses Produkts an die zuständige Abnahmebehörde.
- Um Brände und Stromschläge zu vermeiden, darf dieses Produkt weder Regen noch Feuchtigkeit ausgesetzt werden.
- Schützen Sie das Gerät vor tropfenden oder spritzenden Flüssigkeiten, und stellen Sie keine mit Flüssigkeiten gefüllten Gefäße (z. B. Vasen) auf das Gerät oder in die Nähe des Geräts. Durch den Kontakt mit Flüssigkeiten entsteht ggf. Brandgefahr.
- Stellen Sie keine brennenden Kerzen oder ähnliches auf das Gerät oder in die Nähe des Geräts.
- Dieses Produkt ist nicht für die Installation oder Verwendung in Innenbereichen mit Wassereinrichtungen (zum Beispiel Schwimmbädern, Wasserparks, Räume mit Whirlpools, Saunas, Dampfbäder und Eislaufbahnen) gedacht.



Enthält kleine Teile, die verschluckt werden können und eine Erstickungsgefahr darstellen. Nicht geeignet für Kinder unter drei Jahren.

ACHTUNG:

- Nehmen Sie keine Veränderungen am System oder am Zubehör vor. Nicht autorisierte Veränderungen können die Sicherheit, die Erfüllung von Richtlinien und die Systemleistung beeinträchtigen.



Dieser Warnhinweis weist auf wichtige Bedien- und Wartungsinformationen in dieser Anleitung hin.

1. Lesen Sie die folgenden Anweisungen.
2. Bewahren Sie die Anweisungen auf.
3. Beachten Sie alle Warn- und Sicherheitshinweise.
4. Befolgen Sie alle Anweisungen.
5. Verwenden Sie dieses Gerät nicht in der Nähe von Wasser.
6. Reinigen Sie das Gerät nur mit einem sauberen, trockenen Tuch.
7. Achten Sie darauf, dass die Lüftungsöffnungen nicht blockiert sind. Stellen Sie das Gerät nur in Übereinstimmung mit den Herstelleranweisungen auf.
8. Stellen Sie das Gerät nicht in der Nähe von Wärmequellen auf, wie Heizkörpern, Wärmespeichern, Öfen oder anderen Geräten (auch Verstärkern), die Wärme erzeugen.
9. Verwenden Sie nur Zubehör-/Anbauteile, die vom Hersteller zugelassen sind.
10. Alle Reparatur- und Wartungsarbeiten nur von qualifiziertem Kundendienstpersonal durchführen lassen. Wartungsarbeiten sind in folgenden Fällen nötig: Bei jeglichen Beschädigungen wie z. B. des Netzkabels oder Netzsteckers, wenn Flüssigkeiten oder Gegenstände in das Gehäuse gelangt sind, das Gerät Regen oder Feuchtigkeit ausgesetzt wurde, fallen gelassen wurde oder nicht ordnungsgemäß funktioniert.



Dieses Produkt erfüllt alle vorgeschriebenen EU-Richtlinien. Die vollständige Konformitätserklärung ist einsehbar unter www.Bose.com/compliance.

Leggere questo manuale d'uso e conservarlo come riferimento per il futuro.

Questo prodotto deve essere installato esclusivamente da installatori professionisti. Il presente documento ha lo scopo di fornire agli installatori professionisti le istruzioni di base per l'installazione e la sicurezza del prodotto negli impianti convenzionali a installazione fissa. Leggere attentamente il documento prima di procedere all'installazione.

AVVERTENZE:

- Tutti i prodotti Bose devono essere installati in conformità con gli standard locali, statali, federali e di settore. È responsabilità dell'installatore assicurare che l'installazione del prodotto sia eseguita in conformità con tutte le normative vigenti, compresi i regolamenti edilizi locali. Prima di installare il prodotto, chiedere informazioni all'autorità locale preposta.
- Per ridurre il rischio di incendio o scosse elettriche, il prodotto non deve essere esposto a pioggia o umidità.
- Non esporre l'apparecchio a gocce o schizzi, e non porre oggetti contenenti liquidi quali vasi sopra o in prossimità dell'apparecchio. L'esposizione ai liquidi può provocare il rischio di incendi.
- Non collocare sorgenti di fiamme libere (ad esempio, candele accese) sull'apparecchio o in prossimità di esso.
- Il prodotto non deve essere installato o utilizzato in aree di servizio o intrattenimento vicine all'acqua (ad esempio, piscine coperte, parchi acquatici al chiuso, sale con vasche riscaldate, saune, bagni turchi e piste di pattinaggio al chiuso).



Contiene pezzi di piccole dimensioni che possono rappresentare un pericolo di soffocamento. Non adatto per bambini di età inferiore ai 3 anni.

ATTENZIONE:

- Eventuali modifiche non autorizzate possono compromettere la sicurezza, la conformità alle normative e le prestazioni del sistema, e quindi invalidare la garanzia.



Questo simbolo segnala le istruzioni importanti dal punto di vista del funzionamento e della manutenzione all'interno della guida.

1. Leggere queste istruzioni.
2. Conservare queste istruzioni.
3. Prestare attenzione a tutte le avvertenze.
4. Seguire tutte le istruzioni.
5. Non utilizzare l'apparecchio in prossimità di acqua.
6. Utilizzare solo un panno asciutto per la pulizia.
7. Non ostruire le aperture di ventilazione. Installare il prodotto in conformità con le istruzioni fornite dal produttore.
8. Non installare i diffusori in prossimità di fonti di calore, quali termosifoni, radiatori, stufe o altri apparecchi (compresi gli amplificatori) che generano calore.
9. Utilizzare solo sistemi di aggancio/accessori specificati dal produttore.
10. Affidarsi a personale qualificato per tutti gli interventi di assistenza. Gli interventi di assistenza si rendono necessari quando l'apparato ha subito danni di qualsiasi tipo, ad esempio se il cavo di alimentazione o la spina sono danneggiati, se è stato versato del liquido o sono caduti oggetti sull'apparato, se l'apparato è stato esposto a pioggia o umidità, se non funziona normalmente o è caduto.



Questo prodotto è conforme a tutte le direttive EU prescritte dalla legge. La dichiarazione di conformità completa è disponibile all'indirizzo www.Bose.com/compliance.

Lees deze gebruikershandleiding zorgvuldig door en bewaar deze voor toekomstig gebruik.

Dit product is uitsluitend bestemd voor installatie door professionele installateurs! Dit document is bedoeld om professionele installateurs essentiële installatie- en veiligheidsrichtlijnen te bieden voor dit product in standaardssystemen voor vaste installatie. Lees dit document door voordat u begint met de installatie.

WAARSCHUWINGEN:

- Alle Bose-producten moeten worden geïnstalleerd volgens de plaatselijke en landelijke voorschriften en industriënormen. Het is de verantwoordelijkheid van de installateur om ervoor te zorgen dat de installatie van het product wordt uitgevoerd volgens alle van toepassing zijnde voorschriften, inclusief plaatselijke bouwvoorschriften. Neem contact op met de juiste plaatselijke overheidsinstanties voordat u dit product installeert.
- Stel het apparaat niet bloot aan regen of vocht, om het risico van brand of elektrische schokken te verlagen.
- Stel dit apparaat niet bloot aan druipende of spattende vloeistoffen en plaats geen met vloeistoffen gevulde voorwerpen, zoals vazen, op of bij het apparaat. Blootstelling aan vloeistoffen kan leiden tot brandgevaar.
- Plaats geen open vlam, zoals een brandende kaars, op of bij het product.
- Dit product is niet bedoeld voor installatie of gebruik in overdekte ruimten voor wateractiviteiten (waaronder overdekte zwembaden, overdekte waterparken, stoomruimten, sauna's, bubbelbadkamers en overdekte ijsbanen).



Bevat kleine onderdelen die een verstikkingsgevaar kunnen vormen. Niet geschikt voor kinderen jonger dan 3 jaar.

WAARSCHUWINGEN:

- Er mogen geen wijzigingen aan het product worden aangebracht door onbevoegden. Dergelijke wijzigingen kunnen de veiligheid, de naleving van voorschriften en de werking van het systeem in gevaar brengen en kunnen ertoe leiden dat de garantie vervalt.



Dit symbool geeft aan dat deze handleiding belangrijke gebruiks- en onderhoudsinstructies bevat.

1. Lees deze instructies door.
2. Bewaar deze instructies.
3. Neem alle waarschuwingen in acht.
4. Volg alle instructies.
5. Gebruik dit apparaat niet in de buurt van water.
6. Alleen met een droge doek reinigen.
7. Zorg dat u de ventilatieopeningen niet blokkeert. Installeer het apparaat volgens de instructies van de fabrikant.
8. Installeer het product niet in de buurt van warmtebronnen, zoals radiatoren, warmteroosters, kachels of andere apparaten (waaronder versterkers) die warmte produceren.
9. Gebruik uitsluitend aansluitstukken/accessoires die door de fabrikant worden gespecificeerd.
10. Laat alle reparaties en onderhoud over aan bevoegde servicemedewerkers. Onderhoud is vereist als het apparaat is beschadigd. Dit is bijvoorbeeld het geval als het netsnoer of de stekker is beschadigd, als er vloeistof is gemorst of voorwerpen in het apparaat zijn gevallen, als het apparaat is blootgesteld aan regen of vocht, niet normaal werkt of is gevallen.



Dit product voldoet aan alle vereisten van de EU-richtlijnen, zoals wettelijk vereist. De volledige conformiteitsverklaring kunt u vinden op www.Bose.com/compliance.

Product Features

Bose® ControlCenter zone controllers provide three options for remote volume control and input source selection:

Controller	Function	Compatible Products
CC-1	Volume control only	FreeSpace® IZA 190-HZ ¹ , IZA 250-LZ ¹ , IZA 2120-LZ/HZ FreeSpace ZA 2120-LZ/A - HZ/A FreeSpace DXA 2120 PowerShare PS602, PS404A, PS604A Any ControlSpace® processor
CC-2	Volume control with A/B source selection switch	FreeSpace IZA 190-HZ, IZA 250-LZ, IZA 2120-LZ/HZ FreeSpace DXA 2120 Any ControlSpace processor
CC-3	Volume control with A/B/C/D source selection switch	Any ControlSpace processor

Each zone controller is available in white and black, and in North America, Japan, and EU configurations. The North America zone controllers are sized for Decora® wall mounting, and include two 1/2 inch #6-32 screws. The Japan zone controllers fit Wide 21 wall plates with a face height of 1 mm above the thick wall plate cover; the controllers have approximately 3 mm face height when used with other types of wall plate covers. Two 8 mm M4 screws are included. Wall plate covers are not included with North America and Japan zone controllers. The EU zone controllers come as a finished wall plate of size 86 mm x 86 mm, with 60 to 60.3 mm screw spacing suitable for either vertical or horizontal mounting, and include two 18 mm M4 screws. All models include a sheet of pre-printed color-matched labels.

Connecting a Single Zone Controller

Connect a single zone controller to a FreeSpace or PowerShare amplifier using a CAT 5 cable with maximum length of 609 meters (2000 feet). Connect to a ControlSpace ESP using a CAT 5 cable with a maximum length of 152 meters (500 feet) for a shielded cable or 30 meters (100 feet) for an unshielded cable.

The cable must be terminated on one end with an RJ-45 connection using TIA/EIA 568B pinout, and on the other end with an RJ-45 connector for PowerShare amplifiers, or the Euroblock connector appropriate for the FreeSpace amplifier or ControlSpace processor (2-pin, 4-pin, or 6-pin).

¹ Operates with a fixed input (B). Amp front panel A/B switch is inactive.

Connecting Multiple Zone Controllers

Some amplifier models allow adjacent zone controllers to be ganged together directly. Each zone controller can be independently configured to control any output, or combination of outputs, for bi-amping.

Use a CAT 5 cable with RJ-45 connectors to connect zone controllers to each other, then create a single home run from the last zone controller in the chain back to the amplifier. The maximum total cable length (from the first zone controller to the amplifier) is 609 meters (2000 feet). Use standard CAT 5 cables and RJ-45 connectors as described in Connecting a Single Controller.

CV41 4-to-1 Converter

For PowerShare amplifier models, you can use the CV41 4-to-1 Converter to create a single home run back to an amplifier from multiple zone controllers distributed throughout an installation. Connect each zone controller to the CV41 converter using CAT 5 cables with RJ-45 connectors, then run a single CAT 5 cable from the CV41 4-to-1 Converter to the amplifier. You can connect up to two CC-1 zone controllers to a PS602 amplifier, and up to four CC-1 zone controllers to a PS404A or PS604A amplifier, or any ControlSpace processor.

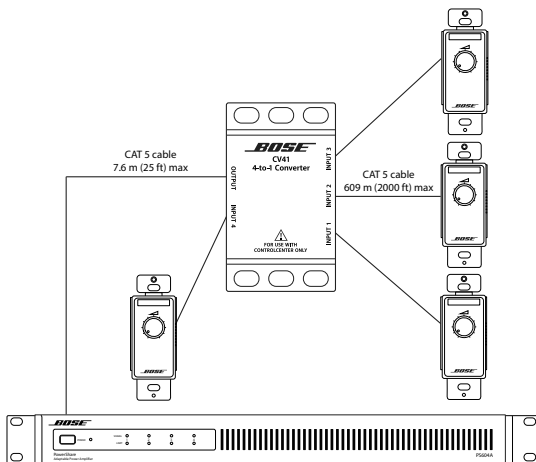

CC-1 Zone Controller

The CC-1 zone controller provides volume control only. It is compatible with FreeSpace® IZA 190-HZ, IZA 250-LZ, IZA 2120-LZ/HZ, ZA 2120-LZ/A - HZ/A; DXA 2120 amplifiers; PowerShare PS602, PS404A, and PS604A amplifiers; and any ControlSpace® processor.

CC-1 Zone Controller - North America

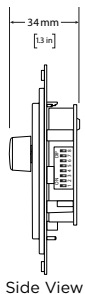
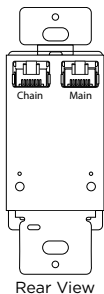
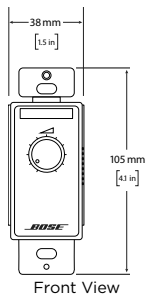

CC-1 Zone Controller - Japan

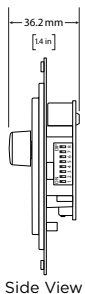
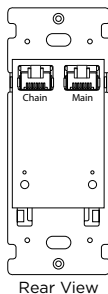
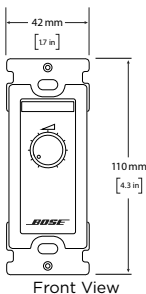

CC-1 Zone Controller - EU

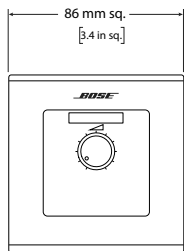

Front View

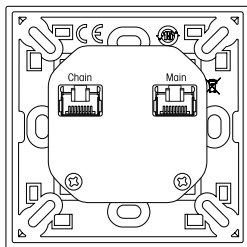

Rear View

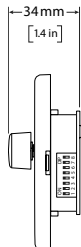

Side View

Pin-to-Remote Connections

Connections from the RJ-45 (TIA/EIA 568B wiring) connector on the CC-1 zone controller to the REMOTE connector on the FreeSpace® amplifier or CONTROL INPUTS connector on the ControlSpace® processor. Use GPI mode A- in CSD. PowerShare requires a separate wire in the CAT 5 cable for COM, PWR, and each VOL_# connection.

Pin	Color	FreeSpace IZA/ZA	FreeSpace DXA 2120	ControlSpace	PowerShare
8	Brown				COM
7	White/Brown				
6	Green			VOL #4	VOL_4
5	White/Blue			VOL #3	VOL_3
4	Blue	VOL #2		VOL #2	VOL_2
3	White/Green	VOL #1	PWR	VOL #1	VOL_1
2	Orange	PWR #2	VOL_2		
1	White/Orange	PWR #1	VOL_1	COM	PWR
				CSD GPI Mode: A-	

Connecting the CC-1 Zone Controller

Connect one CC-1 zone controller to FreeSpace® amplifier models IZA 190-HZ¹, IZA 250-LZ¹, IZA 2120-LZ/HZ, ZA 2120-LZ/A - HZ/A, or DXA 2120, or PowerShare amplifier models PS602, PS404A, or PS604A, or any ControlSpace® processor. Use GPI mode A- CSD. If one CC-1 is to be used in zone 2 of the DXA 2120, then wire into VOL_2. DIP switch settings are the same.

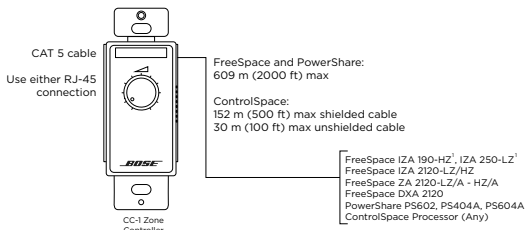

Pin-to-Remote Connection Diagrams

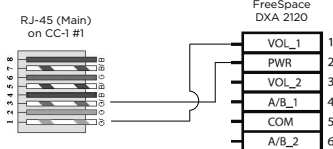
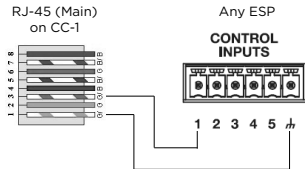
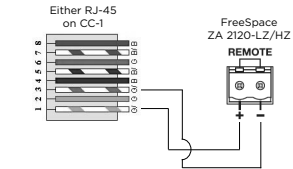
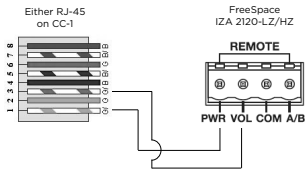

If one CC-1 is to be used in zone 2, then wire into VOL_2. DIP switch settings are the same.

¹ Operates with a fixed input (B). Amp front panel A/B switch is inactive.

Configure the CC-1 zone controller using the following DIP switch settings:

	1	2	3	4	5	6	7	8
FreeSpace IZA/ZA	0	0	1	0	1	0	0	0
FreeSpace DXA 2120	0	0	1	0	1	0	0	0
PowerShare*	0	0	1	0	*	*	*	*
ControlSpace**	0	0	1	0	**	**	**	**

CSD GPI Mode: A-

* For the PowerShare PS602, PS404A, and PS604A amplifiers, the CC-1 controls any outputs with corresponding DIP switches in the ON position:

- DIP 5 - OUTPUT 1
- DIP 6 - OUTPUT 2
- DIP 7 - OUTPUT 3 (PS404A and PS604A only)
- DIP 8 - OUTPUT 4 (PS404A and PS604A only)

** For the DSPs, the DIP switch configuration determines the CC-1 ID:

- DIP 5 - ID 1
- DIP 6 - ID 2
- DIP 7 - ID 3
- DIP 8 - ID 4

FreeSpace IZA/ZA/DXA 2120,
PowerShare Amplifiers,
and ControlSpace Processors



CC-1 Zone Controller #1

Connect two ganged CC-1 zone controllers to FreeSpace® amplifier models IZA 2120-HZ, ZA 2120-HZ/A or DXA 2120; or PowerShare amplifier models PS602, PS404A, or PS604A; or any ControlSpace processor.

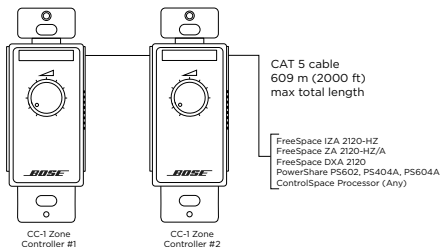

Pin-to-Remote Connection Diagrams

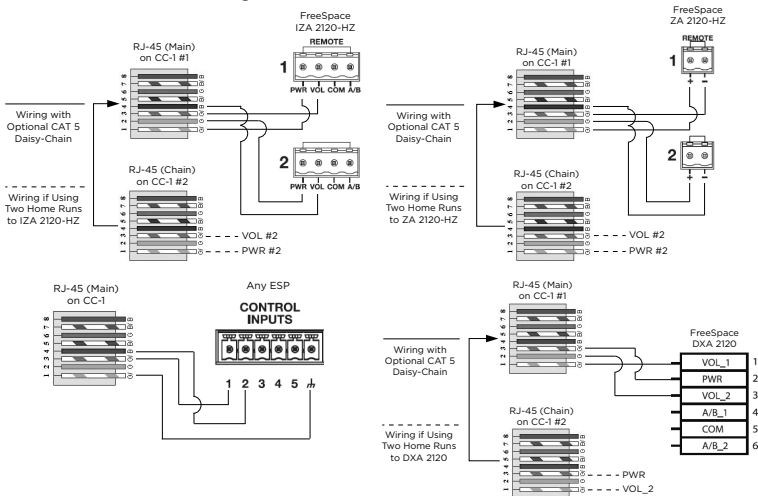

Configure the CC-1 zone controllers using the following DIP switch settings:

		1	2	3	4	5	6	7	8
FreeSpace IZA/ZA	Controller #1	0	0	1	0	1	0	0	0
	Controller #2	0	0	0	1	0	1	0	0
FreeSpace DXA 2120	Controller #1	0	0	1	0	1	0	0	0
	Controller #2	0	0	0	1	1	0	0	0
PowerShare*	Controller #1	0	0	1	0	*	*	*	*
	Controller #2	0	0	1	0	*	*	*	*
ControlSpace**	Controller #1	0	0	1	0	**	**	**	**
	Controller #2	0	0	1	0	**	**	**	**

CSD GPI Mode: A-

* For the PowerShare PS602, PS404A, and PS604A amplifiers, the CC-1 controls any outputs with corresponding DIP switches in the ON position:

DIP 5 - OUTPUT 1

DIP 6 - OUTPUT 2

DIP 7 - OUTPUT 3 (PS404A AND PS604A only)

DIP 8 - OUTPUT 4 (PS404A AND PS604A only)

** For the DSPs, the DIP switch configuration determines the CC-1 ID:

DIP 5 - ID 1

DIP 6 - ID 2

DIP 7 - ID 3

DIP 8 - ID 4

FreeSpace IZA/ZA
Amplifiers

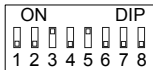

CC-1 Zone Controller #1

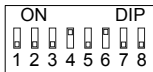

CC-1 Zone Controller #2

FreeSpace DXA 2120
Amplifier

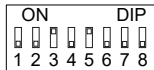

CC-1 Zone Controller #1



CC-1 Zone Controller #2

PowerShare Amplifiers/
ControlSpace DSP (Any)



CC-1 Zone Controller #1



CC-1 Zone Controller #2

Connect up to four ganged CC-1 zone controllers to the PowerShare amplifier models PS404A and PS604A, or any ControlSpace processor.

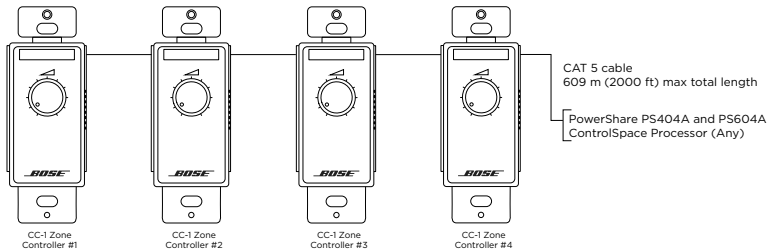

Configure the CC-1 zone controllers using the following DIP switch settings:

	1	2	3	4	5	6	7	8
Controller #1	0	0	1	0	1	0	0	0
Controller #2	0	0	1	0	0	1	0	0
Controller #3	0	0	1	0	0	0	1	0
Controller #4	0	0	1	0	0	0	0	1

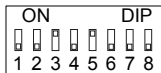

CC-1 Zone Controller #1

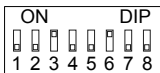

CC-1 Zone Controller #2



CC-1 Zone Controller #3



CC-1 Zone Controller #4

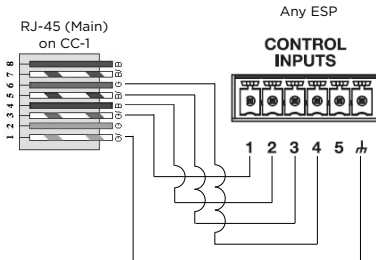

Connect multiple CC-1 zone controllers to PowerShare amplifier models PS602, PS404A, or PS604A using the CV41 4-to-1 converter. Connect up to two CC-1 zone controllers to the PS602 amplifier or up to four CC-1 zone controllers to the PS404A and PS604A amplifiers, or any ControlSpace processor.

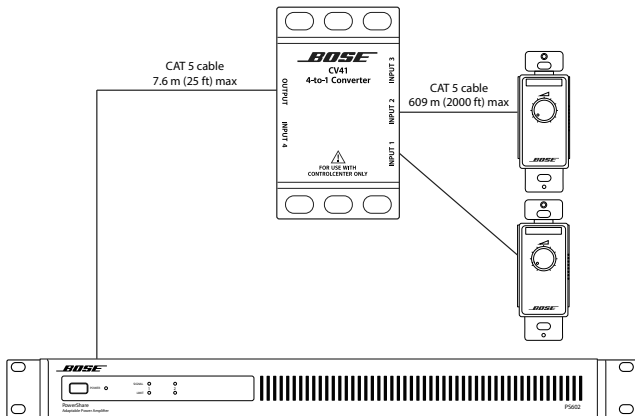

Configure the CC-1 zone controllers using the following DIP switch settings:

	1	2	3	4	5	6	7	8
Controller #1	0	0	1	0	1	0	0	0
Controller #2	0	0	1	0	0	1	0	0



CC-1 Zone Controller #1



CC-1 Zone Controller #2

Connect up to four CC-1 zone controllers to the PowerShare PS404A and PS604A amplifier, or any ControlSpace processor, using the CV41 4-to-1 converter.

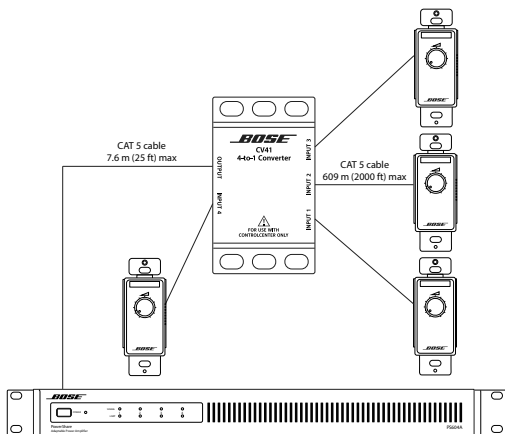

Configure the CC-1 zone controllers using the following DIP switch settings:

	1	2	3	4	5	6	7	8
Controller #1	0	0	1	0	1	0	0	0
Controller #2	0	0	1	0	0	1	0	0
Controller #3	0	0	1	0	0	0	1	0
Controller #4	0	0	1	0	0	0	0	1



CC-1 Zone Controller #1



CC-1 Zone Controller #2

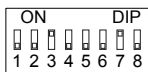

CC-1 Zone Controller #3

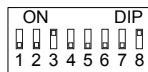

CC-1 Zone Controller #4

CC-2 Zone Controller

The CC-2 zone controller provides volume control and A/B source selection. It is compatible with FreeSpace® amplifier models IZA 190-HZ, IZA 250-LZ, IZA 2120-LZ/HZ, DXA 2120, and any ControlSpace® processor.

CC-2 Zone Controller - North America

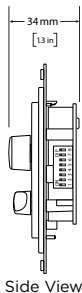
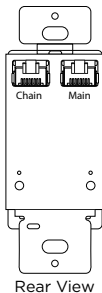
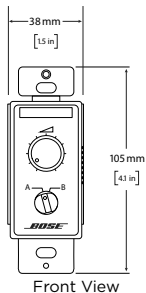

CC-2 Zone Controller - Japan

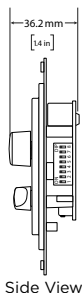
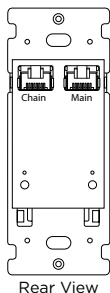
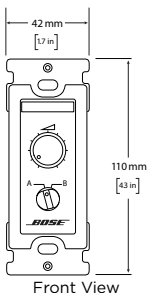

CC-2 Zone Controller - EU

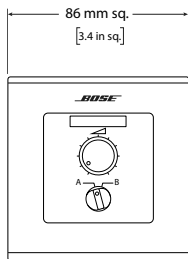

Front View

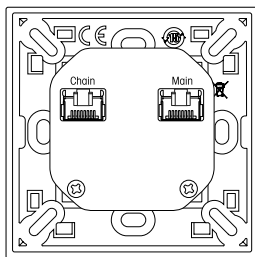

Rear View

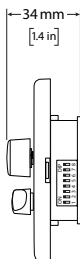

Side View

Pin-to-Remote Connections

Connections from the RJ-45 (TIA/EIA 568B wiring) connector on the CC-2 zone controller to REMOTE connector on the FreeSpace® amplifier or to CONTROL INPUTS connector on the ControlSpace® processor. Use GPI mode A- in CSD.

Pin	Color	FreeSpace IZA	FreeSpace DXA 2120	ControlSpace ESP
8	Brown			
7	White/Brown	A/B Select #2	A/B_2	A/B Select #2
6	Green	A/B Select #1	A/B_1	A/B Select #1
5	White/Blue			
4	Blue	VOL #2		COM #2
3	White/Green	VOL #1	PWR	COM #1
2	Orange	PWR #2	VOL_2	VOL #2
1	White/Orange	PWR #1	VOL_1	VOL #1
				CSD GPI Mode: A-

Connecting the CC-2 Zone Controller

Connect one CC-2 zone controller to FreeSpace® amplifier models IZA 250-LZ, IZA 190-HZ, IZA 2120-LZ/HZ, DXA 2120, and any ControlSpace® processor. Use GPI mode A- in CSD.

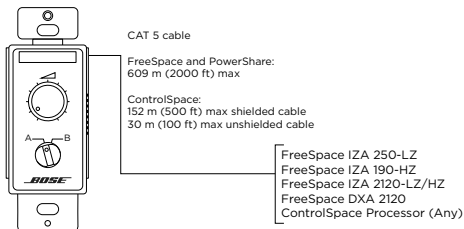

Pin-to-Remote Connection Diagrams

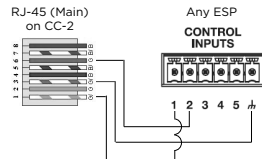
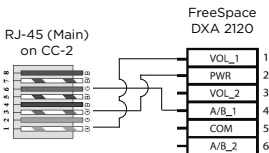
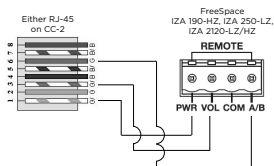

If one CC-2 is to be used in zone 2, then wire into VOL_2 and A/B_2. DIP switch settings are the same.

Configure one CC-2 zone controller using the following DIP switch settings:

	1	2	3	4	5	6	7	8
Controller	1	0	1	0	1	0	0	0



CC-2 Zone Controller

Connect two ganged CC-2 zone controllers to FreeSpace® amplifier model IZA 2120-HZ or DXA 2120, or any ControlSpace processor.

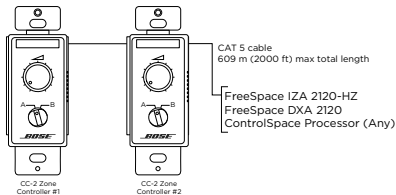

Pin-to-Remote Control Diagrams

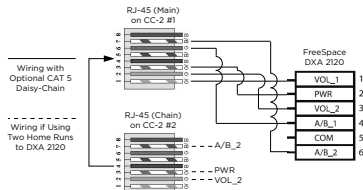
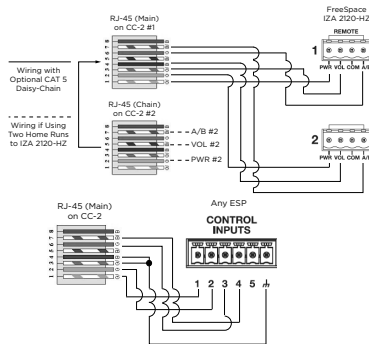

Configure two ganged CC-2 zone controllers using the following DIP switch settings:

	1	2	3	4	5	6	7	8
Controller #1	1	0	1	0	1	0	0	0
IZA/ZA/DSP #2	0	1	0	1	0	1	0	0
DXA 2120 #2	0	1	0	1	1	0	0	0



CC-2 Zone Controller #1

IZA/ZA/DSP

DXA 2120



CC-2 Zone Controller #2



CC-2 Zone Controller #2

CC-3 Zone Controller

The CC-3 zone controller provides volume control and A/B/C/D source selection. It is compatible with any ControlSpace® processor.

CC-3 Zone Controller - North America

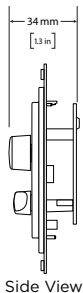
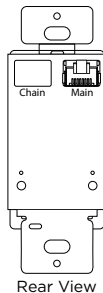
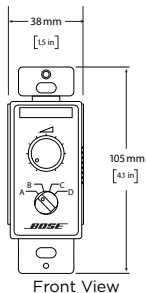

CC-3 Zone Controller - Japan

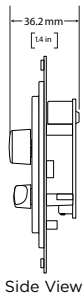
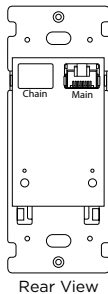
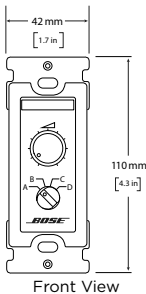

CC-3 Zone Controller - EU

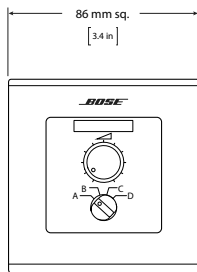

Front View

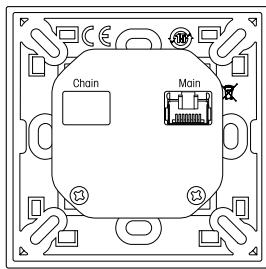

Rear View



Side View

Pin-to-Remote Connections

Connections from the RJ-45 (TIA/EIA 568B wiring) connector on the CC-3 zone controller to the CONTROL INPUTS connector on the ESP. Use GPI mode A+ in CSD.

Pin	Color	ControlSpace
8	Brown	COM
7	White/Brown	A
6	Green	B
5	White/Blue	C
4	Blue	D
3	White/Green	VOL
2	Orange	
1	White/Orange	
CSD GPI Mode: A+		

Connecting the CC-3 Zone Controller

Connect one CC-3 zone controller to any ControlSpace® processor. Use GPI mode A+ in CSD.

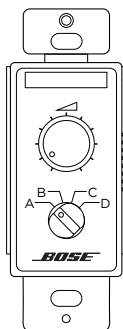

Any ControlSpace Processor

152 m (500 ft) max length CAT 5 shielded cable
30 m (100 ft) max length unshielded CAT 5 cable

Terminated with RJ-45 (TIA/EIA 568 pinout) on one end and 6-pin phoenix on the other end

Pin-to-Remote Connection Diagrams

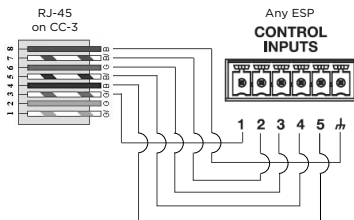

Limited Warranty

Your product is covered by a limited warranty, Visit **pro.Bose.com** for warranty details.

The warranty information provided with this product does not apply in Australian and New Zealand. See our website at **www.bose.com/au/warranty** or **www.bose.com/nz/warranty** for details of the Australian and New Zealand warranty.

Decora® is a registered trademark of Leviton Manufacturing Co., Inc.

Importer Information

European Union

Bose Products B.V., Gorslaan 60, 1441 RG Purmerend, The Netherlands

China

Bose Electronics (Shanghai) Company Limited, Part C, Plan 9, No. 353 North Riyang Road, China (Shanghai) Pilot Free Trade Zone

Taiwan

Bose Taiwan Branch, 9F-A1, No. 10, Section 3, Minsheng East Road, Taipei City 104, Taiwan
Tel: 886 2 2514 7977

Mexico

Bose de México, S. de R.L. de C.V., Paseo de las Palmas 405-204, Lomas de Chapultepec, 11000 México, D.F.
Tel: 001 800 900 2673

Contact Information

Visit us on the web at pro.Bose.com.

Americas

(USA, Canada, Mexico, Central America, South America)
Bose Corporation
The Mountain
Framingham, MA 01701 USA
Corporate Center: 508-879-7330
Americas Professional Systems,
Technical Support: 800-994-2673

Australia

Bose Pty Limited
Unit 3/2 Holker Street
Newington NSW Australia
TEL 61 2 8737 9999

Belgium

Bose N.V. / S.A.
Limesweg 2, 03700
Tongeren, Belgium
TEL (32) 012-390800

China

Bose Electronics (Shanghai) Co Ltd
36F, West Gate Tower
1038 West Nanjing Road
Shanghai, P.R.C. 200041 China
TEL 86 21 6271 3800

France

Bose S.A.S
12 rue de Temara
78100 St. Germain en Laye, France
TEL 01-30-61-63-63

Germany

Bose GmbH
Max-Planck Strasse 36D 61381
Friedrichsdorf, Deutschland
TEL 06172-7104-0

Hong Kong

Bose Limited
Suites 2101-2105, Tower One, Times Square
1 Matheson Street, Causeway Bay, Hong Kong
TEL 852 2123 9000

India

Bose Corporation India Private Limited
Salcon Aurum, 3rd Floor
Plot No. 4, Jasola District Centre
New Delhi - 110025, India
TEL 91 11 43080200

Italy

Bose SpA
Centro Leoni A - Via G. Spadolini
5 20122 Milano, Italy
TEL 39-02-36704500

Japan

Bose Kabushiki Kaisha
Shibuya YT Building
28-3 Maruyama-sho
Shibuya-Ku, Tokyo, 150, Japan
TEL 81-3-5489-0955
www.bose.co.jp

The Netherlands

Bose BV
Nijverheidstraat 8 1135 GE
Edam, Nederland
TEL 31 (0)299-390139

United Kingdom

Bose House
Quayside Chatham Maritime
Chatham, Kent ME4 4QZ, United Kingdom
TEL 44 (0)3330-142545

See website for other countries



771705-0010

©2017 Bose Corporation, All rights reserved.
Framingham, MA 01701-9168 USA
www.pro.bose.com

All trademarks are the property of their respective owners
AM771705 Rev. 01
May 2017

