



LT-800-072 Stationary FM Transmitter
LT-800-216 Stationary FM Transmitter

Don't miss a single sound.





Dear Valued Customer,

Thank you for choosing Listen! All of us at Listen are dedicated to providing you with the highest quality products available. We take great pride in their outstanding performance because we care that you are completely satisfied. That's why we independently certify them to the highest quality standards and back them with a limited lifetime guarantee. We stand ready to answer any questions you might have during installation or in the operation of our products. Should you experience any problems whatsoever with your Listen products, we are ready to help you in any way we can with prompt, efficient customer care. Because at Listen, it's all about you! And should you have any comments on how we might improve our products or our service, we're here to listen.

Here's how to reach us:

+1.801.233.8992

+1.800.330.0891 North America

+1.801.233.8995 fax

support@listentech.com

www.listentech.com

Thank you and enjoy your listening experience!

Best regards,

Russell Gentner and the Listen Team

- In the few instances where repairs were needed, 99% of all clients indicated that they were happy with repair turn-around-times and 85% of the time, clients were without their product for less than 10 days!
- Overall client satisfaction of working with Listen was rated 4.8 out of 5.
- "Please continue with your excellent attitude toward customer satisfaction. You guys are great!"
- "I've never had such good service from any company. Keep up the good work!"
- "You stand behind your product wonderfully."

LT-800 Table of Contents

Package Contents	3
Specifications	4
Architectural Specifications	4
Specifications	4
Block Diagram	5
Quick Reference	6
Setup Instructions	7
Operating Instructions	10
Audio Control	11
Listen SQ™ (Super Quiet)	12
RF Reception Maximization Strategies	13
Coaxial Cable	13
Channel Selection	14
Compatibility Charts	15
72 MHz Frequency Compatibility Chart	15
216 MHz Frequency Compatibility Chart	16
Phonak Frequency Compatibility Chart	17
Supplementary Information	18
Troubleshooting	18
Compliance Notice	20
FCC Statement	20
Warranty	21
Contacting Listen	21
Optional Accessories	22

LT-800 Package Contents

LT-800 Contents

- LT-800-072 (72 MHz) or
- LT-800-216 (216 MHz) or
- 12 VDC Power Supply
- User Manual

Listen Part Number

LT-800-072 (72 MHz)
LT-800-216 (216 MHz)



Optional Accessories

See page 22

LT-800 Specifications

Architectural Specifications

The stationary FM transmitter shall be capable of broadcasting on 57 channels. The transmitter shall have a SNR of 80dB or greater. The output power shall be adjustable to quarter, half or full. Channel tuning shall be capable of being locked. The device shall broadcast on both wide and narrow band channels. The device shall have an audio frequency response of 63 Hz to 15k Hz, ± 3 dB at 72 MHz, or of 63 Hz to 10k Hz, ± 3 dB at 216 MHz. It shall have two mixing audio inputs. The device shall have the following audio controls: input level, mix level and an adjustable low pass filter. The device shall have an audio processor that is capable of automatic gain control and limiting. The Listen LT-800 is specified.

Specification

	Specifications	LT-800-072	LT-800-216
RF	RF Frequency Range	72.025 - 75.950 MHz	216.025 - 216.9875 MHz
	Number of Channels	17 wide band, 40 narrow band	19 wide band, 38 narrow band
	Frequency Accuracy	+/- .005% stability 32° to 122°F (0° - 50°C)	
	Transmitter Stability	50 PPM	
	Output Power	80,000uV at 3 m	100mW (max allowed by FCC)
	Antenna	Various Antennas available	
	Antenna Connector	BNC	
	Compliance	FCC Part 15, Industry Canada	FCC Part 90, Industry Canada
** All system specifications are wireless end-to-end			
Audio	System Frequency Response	50 Hz - 15 kHz (± 3 dB)	50 Hz - 10 kHz (± 3 dB)
	System Signal to Noise Ratio (A-Weighted)	80 dB SQ enabled; 60 dB SQ disabled	80 dB SQ enabled; 50 dB SQ disabled
	System Distortion	<2% total harmonic distortion (THD) at 80% deviation	
	Audio Input 1	Rear panel. (1) Female-XLR and ¼ in. combo connector, balanced, 0/-55 dBu (line/mic) nominal input level adjustable, -30/+21 dBu (line/mic) maximum input level, impedance 20k/1k Ohms (line/mic), phantom power +12 VDC.	
	Audio Input 2	Rear panel. Two (2) Phono connectors, unbalanced, -10/+10 dBu nominal input level adjustable, +30 dBu maximum, impedance 100k Ohms.	
	Audio Processing (Process)	Compression can be turned on/off. Slope internally adjustable from 1:1 to 4:1. Default 2:1	
	Contour	Cuts and boosts frequencies above 5 kHz	
	Combined Audio Output (Mix)	Input 1 and Input 2 Mixed Output (Rear Panel). Two (2) phono connectors, unbalanced, -10 dBu nominal output level, +19 dBu maximum, impedance 10 ohm.	
Headphone Output (Monitor)	Front panel. One (1) 3.5 mm stereo connector, unbalanced, adjustable output level, +7 maximum, impedance 10 Ohm.		
Controls	Front Panel	Power, Test Tone on/off, Channel UP/DOWN, Input levels, Mix level, Contour, Monitor volume control.	
	Rear Panel	Input 1 Level (line, mic, mic-phantom power), Input 2 Level (-10/+10 dBu), RF Power (low, mid, high)	
	Internal Adjustments	Compression ratio for audio processor	
	Programming	SQ on/off, Processing on/off. Channel lock	
Indicators	Input 1 and Input 2, Mix VU	Indicates Input 1, Input 2 and Mix audio levels. 10 segment LED's (8 green, 2 red)	
	SQ and Processing	Indicated by a green LED when on (front panel)	
	RF Power	Indicated on the LCD (low, mid, high)	
	LCD Display	Channel designation, lock status, RF Power Level, programming (front panel)	
	Test Tone	Red LED illuminates when test tone enabled	
Power	Power Supply Type	In-line power supply. Listen part number LA-207 (Line cord is determined by each country's AC power standards).	
	Power Supply Input	Input: 100-240 VAC, 50-60 Hz, 0.4 A	
	Power Supply Output	Output: 12 VDC, 1.3 A, 15.6 W	
	Power Supply Connector	Output Connector: .02 in. (5.0 mm) OD, .01 in. (2.5 mm) ID, barrel type	
	Power Supply Compliance	UL, CE, GS, TUV	
Physical	Dimensions (H x W x D)	1.75 x 8.50 x 9.13 in. (4.5 x 21.5 x 23 cm)	
	Color	Dark Grey with white silk screening	
	Unit Weight	2.6 lbs. (5.7 kg)	
	Unit Weight with LA-201	4.4 lbs. (2.0 kg)	
	Power Supply		
	Shipping Weight	5.0 lbs. (2.26 kg)	
	Rack Mounting	One (1) rack space height, 1/2 rack space wide. One (1) or two (2) transmitters can be mounted in one rack space. Optional rack mount (LA-326)	
Environmental	Temperature - Operation	-10°C (14°F) to +40°C (104°F)	
	Temperature - Storage	-20°C (-4°F) to +50°C (122°F)	
	Humidity	0 to 95% Relative Humidity, non condensing	

Specifications are subject to change without notification

LT-800 Block Diagram

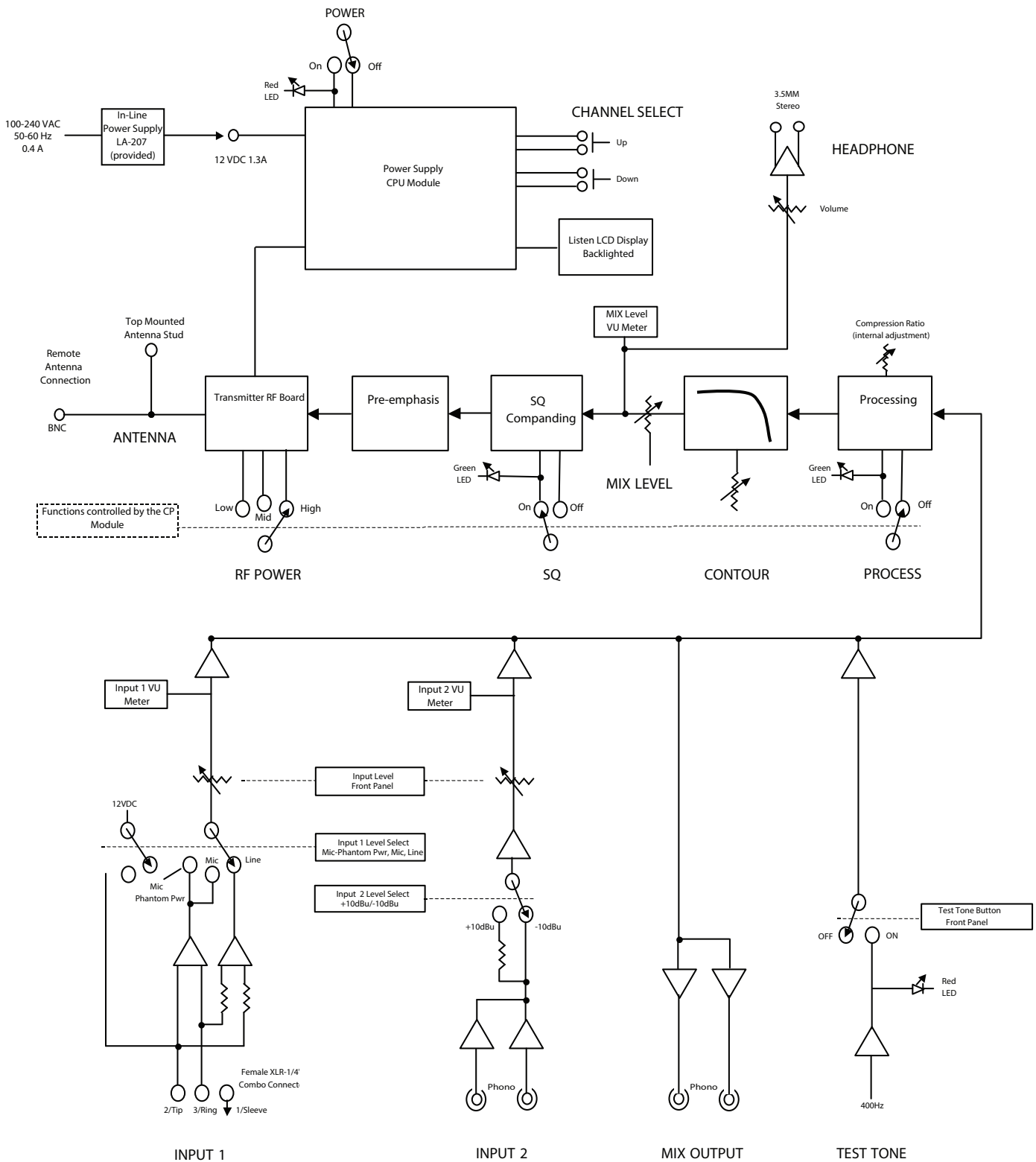

LT-800 Quick Reference

LT-800 Front Panel: Controls & Displays

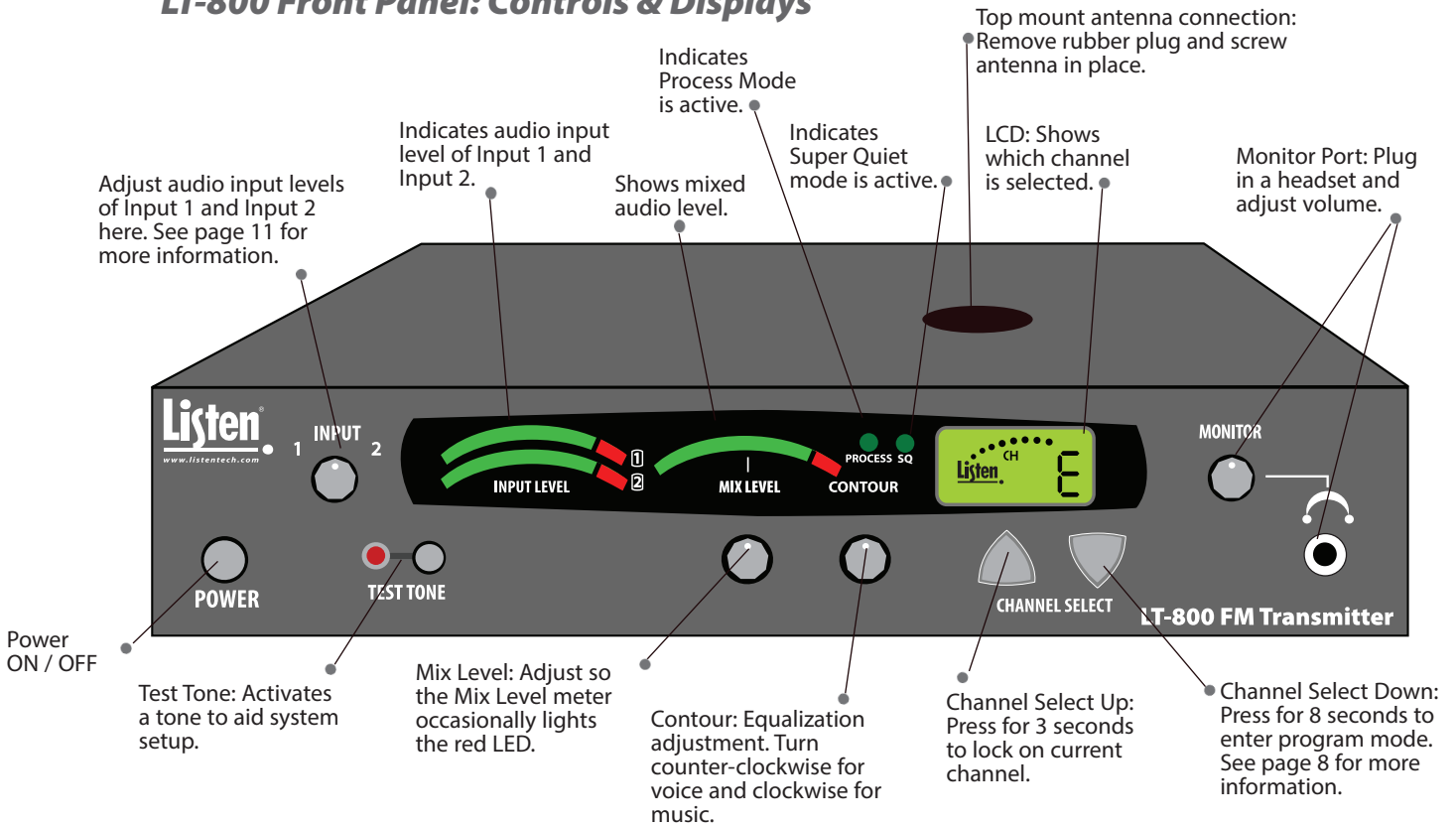

LT-800 Back Panel: Connections & Settings

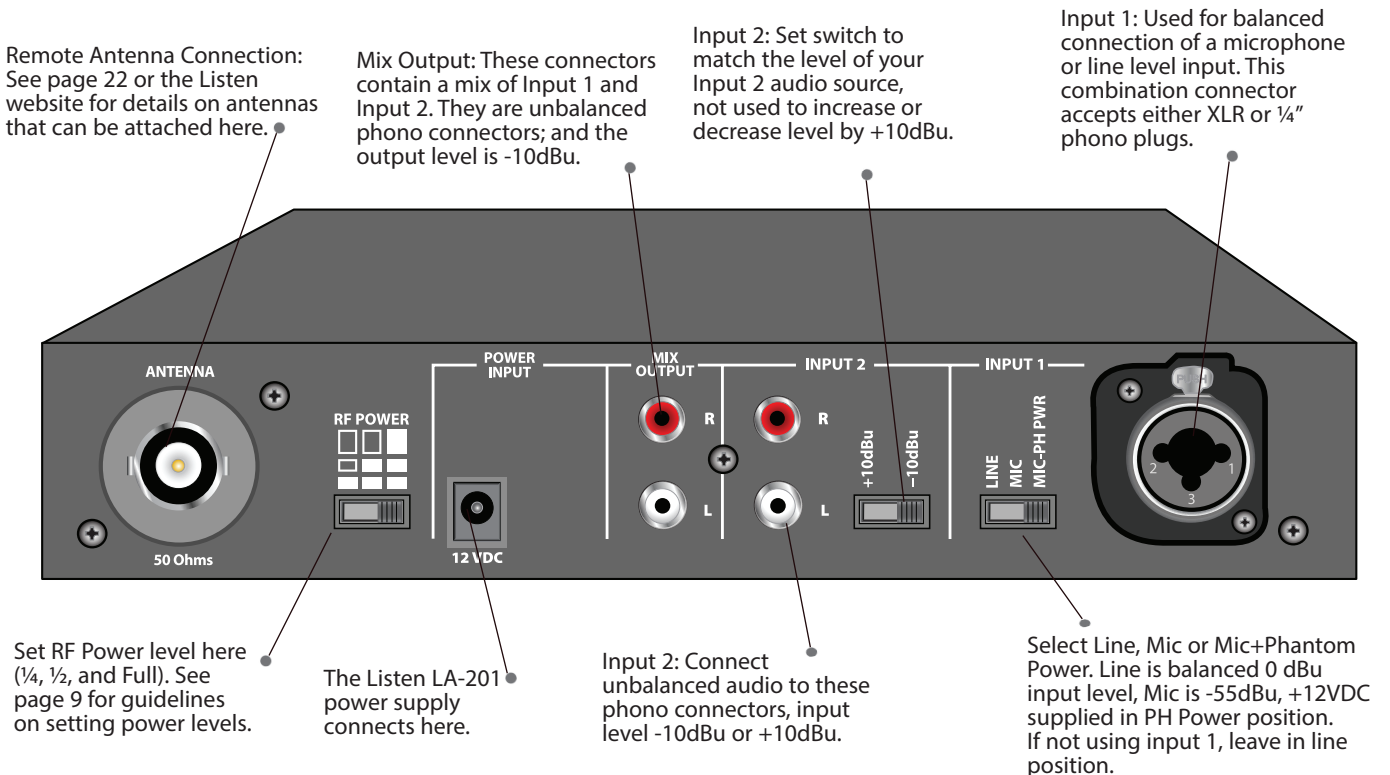

LT-800 Setup Instructions

1 Unpack the Product

Remove outer packaging and plastic cover. Inspect for physical damage.

2 Mount in Rack (if necessary)

If rack mounting the unit, install the optional rack mount kit (part LA-326) according to the instructions included with the kit, then install the LT-800 in the rack.

NOTE: If rack mounting, you will need to use a rear connection antenna.

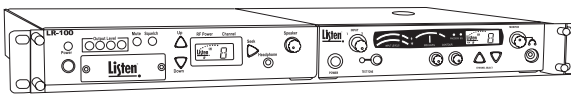

Rack Mount with dual unit installed

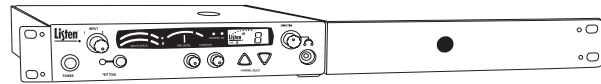

Rack Mount with single unit installed
Shown with LT-800

3 Connect Antenna

Connect the antenna (not included) according to the installation instructions. Only use an antenna supplied by Listen. If you are connecting the antenna directly to the top of the LT-800, you will need to remove the rubber plug on top of the unit. If you are using a remote antenna connected to the rear of the unit, do not connect an antenna to the top connector. See page 22 for antenna options, or refer to the Listen website for remote antenna options, www.listentech.com.

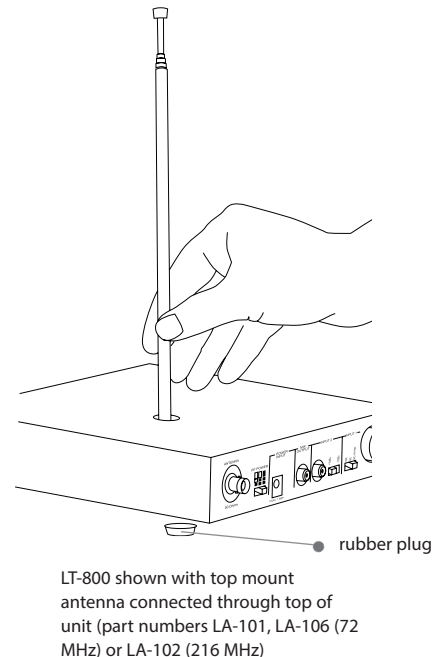
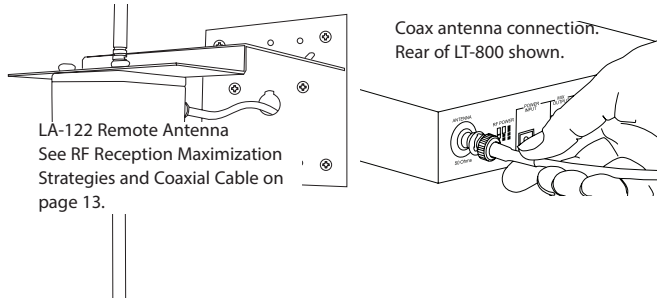

4 Connect Power

Plug the power supply into the power connector on the back panel, then plug the power supply into an outlet. Only use a Listen approved power supply (The LA-207, an in-line switching power supply, is the approved power supply for this unit).

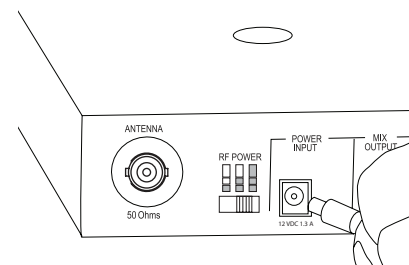

5 Select Phonak Compatibility (if necessary)

If you will be using Phonak receivers with your LT-800 (216 MHz only), the transmitter can become completely compatible through software control. When switched to this mode, the LT-800 transmitter will display the Phonak channels. By integrating Phonak channels and compatibility into the LT-800-216, it is more convenient to use Phonak receivers with Listen transmitters. (www.phonak.com)

LT-800 Setup Instructions (cont.)

To Select Phonak Mode:

Press and hold down the channel select “up” button while powering on the unit. The LCD will display a “P” momentarily upon power up indicating that the transmitter is in the Phonak Channel Mode. The channels displayed will now match Phonak channels. To return to the Listen channel designations, repeat this process. The LCD will display an “L” momentarily upon power up indicating that you are in the Listen Channel Mode.

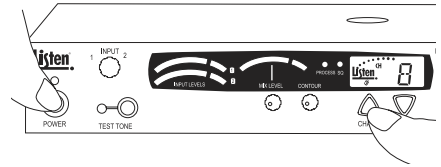

6 Select Channel Mode (if necessary)

Your transmitter has been shipped to you with only a limited number of channels available (Basic Mode). If all channels (Expanded Mode) are required, use the following procedure.

To Select Expanded Mode:

To enable or disable the Expanded Mode, press and hold the channel select “down” button while powering on the unit. When the Basic Mode is enabled, “L/O” (lockout) will be displayed on the LCD display as shown below. This indicator is extinguished when in the Expanded Mode.

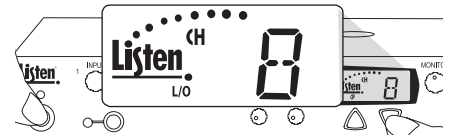

7 Set SQ™ (Super Quiet) and Process Features

Your transmitter is shipped to you with SQ (super quiet) enabled and Process disabled. For a detailed description of these features and when to use them, please refer to page 12.

To Disable or Enable SQ and Process Features:

With the unit on press and hold the channel select “Down” button for 8 seconds. The program (PGM) icon will appear on the LCD.

Once in the program mode,



the SQ and Process features can be turned on and off by pressing the channel select buttons. Press the channel select “Up” button to toggle between Process On and Off. Press the channel select “Down” button to toggle between SQ On and Off.

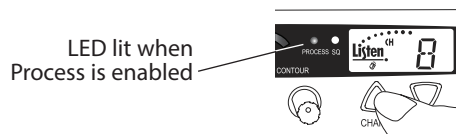

If the green LED is illuminated on the front panel, that feature is enabled. Once you have enabled or disabled the features as desired, let the transmitter exit the program mode by waiting 5 seconds.

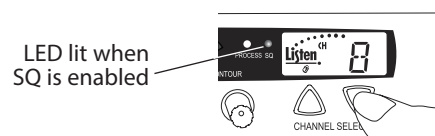

LT-800 Setup Instructions (cont.)

8 Set RF Power

Set the RF POWER switch on the back of the unit to Full, 1/2 or 1/4 (Level is indicated on the LCD display). The amount of transmitted RF power that you will need depends on your application. If you are operating multiple transmitters in the same environment, it is best to set the transmitters output power to its lowest level to reduce the possibility of interference.

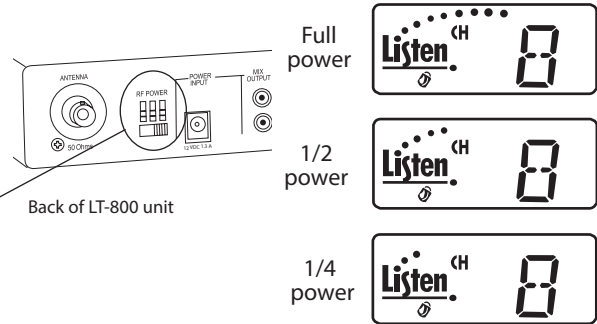

9 Connect Audio Inputs

The LT-800 has two audio input options: Input 1 and Input 2. Input 1 is a balanced connection using either an XLR or 1/4" phono connector. Input 2 has two unbalanced mixing phono connectors. Use Input 1 if you are using a microphone or if you have a balanced connection such as from a professional audio mixer (you can also use Input 1 for unbalanced connections). Use Input 2 to connect to an unbalanced audio source.

Input 1

Connect the audio source(s) to one or both audio input connections. Input 1 offers a choice of balanced XLR or 1/4" phono connector.

Plug your microphone into Input 1 and move the input select switch to Mic (for dynamic microphones) or Mic + PH Power (for condenser microphones).

Plug your balanced or unbalanced audio source into Input 1. Use the following diagram.

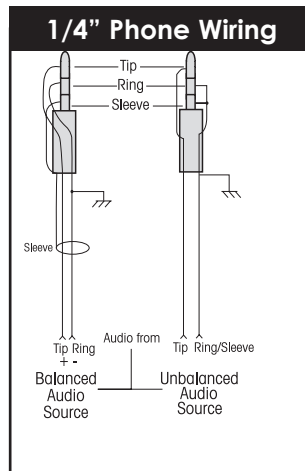
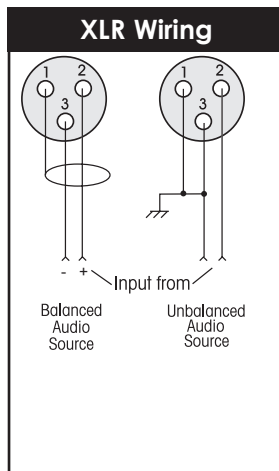
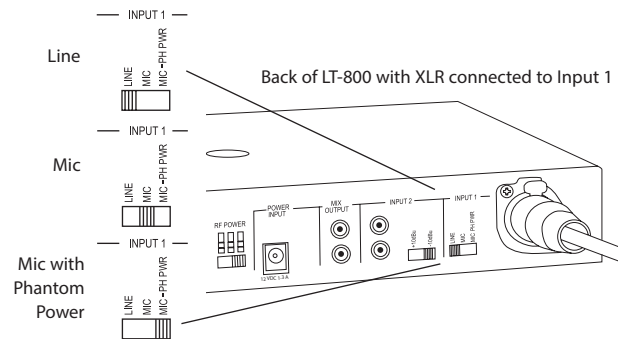

7 Input 2

Plug your unbalanced audio source into Input 2 and select the audio level switch for -10dBu or +10dBu, to match the audio level coming from your equipment.

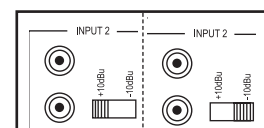

LT-800 Operating Instructions

1 Power Unit On

Turn power on by pressing the power button.

2 Select a Channel

Select the transmit channel by pressing the channel select UP and DOWN buttons. See Channel Selection on page 14 for more information.

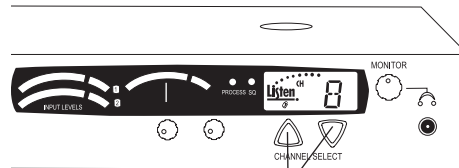

• Channel Select UP and DOWN buttons

NOTE: The LT-800 is shipped with only limited channels (Basic Mode). To select from all channels (Expanded Mode) refer to page 12. (for a more detailed description of Basic and Expanded Mode refer to page 12)

3 Lock on Channel

Once you determine your transmit channel, you can lock the transmitter on that channel. To lock a channel hold the Channel Select "Up" button for 3 seconds until the padlock icon appears on the display. To unlock, repeat this process and the padlock icon will disappear.



4 Test Tone (if necessary)

To broadcast a test tone, press the test tone button. This helps to test receivers when no audio source is available.

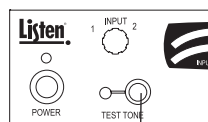

• Press Test Tone button here

LT-800 Audio Control

1 Adjust Audio Input Level

Adjust the input knob counterclockwise to add gain to Input 1. This will decrease gain to Input 2. Adjust input knob clockwise to add gain to Input 2. This will decrease gain to Input 1. If you have two audio sources connected to both Input 1 and 2, adjust the level of one input using the VU meter, then adjust the output level of the other audio source. Adjust the input level until the left VU meter(s) occasionally illuminate the red LEDs. Illumination of the red LEDs indicates the unit is in limiting. Limiting is required so that the unit does not over-modulate the transmitter. If you don't want any audio limiting to occur, make sure the red LEDs never illuminate. If you want a highly limited signal, turn the audio gain up so the red LEDs illuminate often.

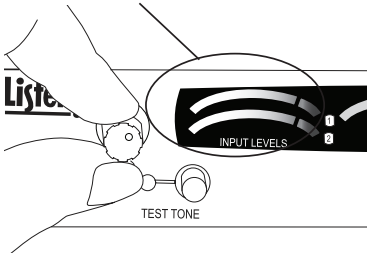

2 Adjust Contour

Adjust the Contour knob counterclockwise if your audio source is mostly voice. Adjust the knob clockwise if your audio source is mostly music. The Contour knob adjusts the relative equalization of the unit. This equalization boosts or cuts frequencies above 5 kHz.

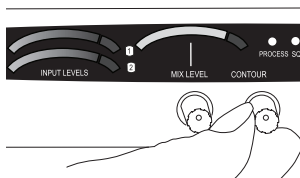

3 Adjust Mix Level

Adjust the mix level until the right VU meter occasionally illuminates the red LED. This is the level adjustment for the combined output from Input 1 and Input 2.

If you are using another manufacturer's receivers with the LT-800, determine the frequency of their receivers then refer to Listen's Frequency Compatibility Tables (pages 15-16) to find the LT-800 channel that corresponds with the receiver's frequency. We recommend verifying corresponding channel designations on these tables to ensure compatibility and provide the best possible reception.

The LT-800 is Phonak compatible and can be set to display Phonak specific channels. See page 8 to set Channel Mode and page 14 for specific channel designations.

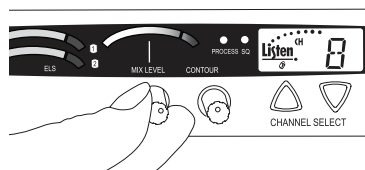

Listen SQ™ (Super Quiet) - Improving Your Listening Experience

People are accustomed to listening to low noise, high fidelity audio (delivered via CD, DVD, etc.). FM radio systems, such as those made by Listen, have more inherent noise compared to most sound systems. To minimize noise, Listen uses a noise reduction technology called ListenSQ™. Both the transmitter and receiver must have the SQ feature enabled to achieve the desired results. SQ is available on new Listen systems, including the system you received in this shipment. If you are planning to use this product with older Listen systems that do not have Listen SQ, or equipment not manufactured by Listen, you must disable Listen SQ.

Your Listen LT-800 has been shipped to you with the SQ feature enabled. You may need to disable the SQ function for one or more of the following reasons:

- 1 You are using your new Listen LT-800 with older version Listen receivers that do not have the SQ function.
- 2 You are using your new Listen LT-800 with equipment supplied by other manufacturers (Listen is the only manufacturer using SQ Technology).
- 3 You expect that end users will bring and use their own receivers that don't have the SQ function.

NOTE: See page 8 to enable or disable SQ (Super Quiet).

Process Mode

Process mode is used for Audio Gain Control (AGC). With the process mode enabled, the LT-800 will automatically adjust for inconsistent signal input levels by raising or lowering the signal level accordingly to provide a consistent sound output level. This feature should be used in applications where a consistent sound level is important and the input levels vary substantially. Typically you would not want to engage the Process Mode when a speaker's emphasis is critical to the message they are conveying.

Basic and Expanded Mode

In the default Listen channel mode, only the most commonly used channels are available. This is called "Basic Mode". When the LT-800 is in Basic Mode, "L/O" (lock-out) will be displayed on the LCD, meaning some transmission channels are unavailable. If the channel needed is not available in Basic Mode, access to all transmission channels is achieved in "Expanded Mode". To access Expanded Mode press and hold the channel select "down" button while powering on the unit. To return to Basic Mode, repeat the same process of powering on the unit while holding the "down" button.

SQ Summary

- SQ is NOT squelch
- SQ improves noise performance by at least 20dB
- SQ is NOT compatible with older version Listen products
- SQ is NOT compatible with other manufacturers' products
- To work properly, SQ must be enabled for both the transmitter and receivers
- SQ can be disabled to permit operation with older Listen products or other manufacturers' products

RF Reception Maximization Strategies

For proper and dependable operation, Listen receivers need to receive a strong and consistent signal from the originating transmitter. Note that on portable receivers the headset wire is the receiving antenna. The following strategies should be used maximize this signal:

- 1 When designing and installing your system, keep in mind that the location of both the transmitting and receiving antennas is critical to maximize broadcast range.
- 2 Eliminate or minimize obstructions between the transmitting and receiving antenna.
- 3 Minimize the distance between the transmitting and receiving antennas.
- 4 Move transmitting and receiving antennas away from metal or conductive objects.
- 5 Place the transmitting antenna as high as possible.
- 6 Orient both transmitting and receiving antennas vertically.
- 7 Position the RF Power switch on the back of the LT-800 to full RF Power, unless lower power is necessary (see page 9).
- 8 Keep coaxial cable from transmitter to antenna as short as possible.

CAUTION: When installing antennas, ensure the antenna is clear of power lines.

Coaxial cable, connectors, and optional antenna mounting kits are available from Listen. See page 22-23, visit www.listentech.com or ask your dealer for details.

Coaxial Cable

The antenna for the LT-800 can be mounted directly on the unit if desired. However, you may find that the unit will provide better performance when the antenna is located elsewhere. If you plan to mount the antenna in a different location other than the top of the unit, you must use cable and connectors rated at 50 ohms. Although cable used for cable TV installations looks similar to this cable, it will not work with your Listen system.

If you need to run cable over a length greater than 50 feet for 216 MHz applications or greater than 100 feet for 72 MHz applications or to maximize broadcast range, Listen recommends that you use RG-8 cable rather than RG-58. RG-8 is a lower loss cable, meaning that more of your signal will reach the antenna.

Long cable runs can result in signal degradation due to the "loss" characteristics of the cable. When using RG-58 with a 72 MHz transmitter, there is an average* loss of 4 dB per 100 feet of cable and at 216 MHz using RG-58 an average* loss of 8 dB per 100 feet of cable. (A 3dB loss means half of your power has been lost.) However, it is better to suffer coaxial power loss than to try to shoot your signal through obstacles! Obstacles, especially metal, can create drop-outs or reflections of your signal that will result in poor listening conditions.

***NOTE:** There are many varieties of 50 ohm, RG-58 and RG-8 cables. You may purchase a cable that is better or worse than this value. Please check with the cable vendor or manufacturer for exact specifications.

Channel Selection

It is important to choose channels that are free from interference to achieve proper operation of your Listen equipment. This process is trial and error. Before turning on the transmitter, listen to the wide band channels on the receivers (lettered channels at 72 MHz and channels that start with a "2" for 216 MHz when using a Listen receiver). Listen to the audio through the headphone or via the speaker and choose a channel with the least amount of interference. Unless you are interfacing with an existing narrowband transmission system, always use a wide band channel.

If you are using multiple channels follow this process:

1. **Same Space** If you are using multiple transmitters in the same space, the highest number of channels that will work simultaneously is six at 72 MHz and three at 216 MHz. With all of the transmitters off, listen for interference on all the wide band channels with a Listen receiver. Using the frequency compatibility tables on pages 15-17, eliminate any channels that have noticeable interference. Now choose the channels with the widest channel spacing. It is recommended that adjacent channels be spaced at least 300k Hz apart. If there is no interference the following channels are recommended. For a 72 MHz system, use channels A, C, E, I, J and H. For a 216 MHz system, use channels 2A, 2K and 2V.
2. **Distributed Spacing** If you are using transmitters that are distributed over a large area, you can achieve more simultaneous broadcast channels. However, it is critical that your receiver(s) be located as close to its transmitter as possible. You can use adjacent channels (see frequency compatibility tables (on pages 15-17) in this case as long as the adjacent channel transmitter is at least 50% further away from the receiver than the original transmitter. Example: The transmitter for the receiver on channel E is 100 feet from the receiver. The adjacent channel transmitter on channel D should be at least 150 feet away.

It is highly recommended that after channel selection has been achieved, you lock the channel so that it cannot be changed by the user. To accomplish LOCK on the LT-800, press the "UP" button for 3 seconds. Repeat the process to unlock.

Notes in regard to using 72 MHz and 216 MHz systems:

1. 72 MHz is a secondary frequency band. This means that other transmitters are licensed to use these frequencies. Thus, you may experience interference from paging transmitters and other types of transmissions. You will need to find a clear channel by listening to all the wide band channels.
2. 216 MHz is a primary frequency band and no other types of transmissions are authorized to use it. Thus, you will find the highest probability of clear channels in this band. However, you may experience intermodulation of the TV Channel 13 aural carrier if there is a channel 13 transmitter in your area and you are close to the transmitter. If you cannot find a clear channel in 216 MHz band due to channel 13, it is recommended that you switch to a 72 MHz system.

Wide Band Recommendation

Listen recommends that you always use a wide band channel unless you need to be compatible with existing narrow band receivers from other manufacturers. Wide band channels have lower noise than their narrow band counterparts.

At 72MHz

The LT-800 at 72 MHz operates on 17 wide band channels and 40 narrow band channels.

- Letters= Wide Band Channels (Example: E)
- Numbers= Narrow Band Channels (Example: 32)

At 216MHz

The LT-800 at 216 MHz operates on 19 wide band channels and 38 narrow band channels.

- "2" as left digit= Wide Band Channel (Example: 2C)
- "1" and "3" as left digits= Narrow Band Channels (Examples: 1A; 3R)

72 MHz Compatibility Chart

Frequency MHz	Phonic							
	Listen	Ear	Comtek	Phonak	Williams*	Gentner	Telex	Drake
72.0250	1	1	1	A1	(11, 1)			
72.0500					(2)	1		
72.0750	2	2	2	A2	(12, 3)			
72.1000	A	A	A	A	A, (13, 4)	2	A	72.1
72.1250	3	3	3	A3	(14, 5)			
72.1500					(6)	3		
72.1750	4	4	4	A4	(15, 7)			
72.2000	K	K		K	K, (8)	4	B	72.2
72.2250	5	5	5	K5	(16, 9)			
72.2500					(10)	5		
72.2750	6	6	6	K6	(17, 11)			
72.3000	B	B	B	B	B, (18, 12)	6	C	72.3
72.3250	7	7	7	B7	(19, 13)			
72.3500					(14)	7		
72.3750	8	8	8	B8	(20, 15)			
72.4000	N	N		N	N, (16)	8	D	72.4
72.4250	9	9	9	N9	(21, 17)			
72.4500					(18)	9		
72.4750	10	10	10	N0	(22, 19)			
72.5000	C	C	C	C	C, (23, 20)	10	E	72.5
72.5250	11	11	11	C1	(24, 21)			
72.5500					(22)	11		
72.5750	12	12	12	C2	(25, 33)			
72.6000	O	O		O	O, (24)	12	F	72.6
72.6250	13	13	13	O2	(26, 25)			
72.6500					(26)	13		
72.6750	14	14	14	4	(27)			
72.7000	D	D	D	D	D, (28)	14	G	72.7
72.7250	15	15	15	D5	(29)			
72.7500					(30)	15		
72.7750	16	16	16	D6	(30, 31)			
72.8000	P	P		P	P, (32)	16	H	72.8
72.8250	17	17	17	P7	(31, 33)			
72.8500					(34)	17		
72.8750	18	18	18	P8	(32, 35)			
72.9000	E	E	E	E	E, (33, 36)	18	I	72.9
72.9250	19	19	19	E9	(34, 37)			
72.9500					(38)	19		
72.9750	20	20	20	E0	(35, 39)			
74.6250	33	33	33	E3	(36, 40)			
74.6500					(41)	20		
74.6750	34	34	34	E4	(37, 42)			
74.7000	I	I	I	I	I, (38, 43)	21	O	
74.7250	35	35	35	I5	(39, 44)			
74.7500					(45)	22		
74.7750	36	36	36	I6	(40, 46)			
75.2250	37	37	37	I7	(41, 47)			
75.2500					(48)	23		
75.2750	38	38	38	I8	(42, 49)			
75.3000	J	J	J	J	J, (43, 50)	24	P	
75.3250	39	39	39	J9	(55, 51)			
75.3500					(52)	25		
75.3750	40	40	40	J0	(45, 53)			
75.4000	R	R		R	R, (54)	26	Q	
75.4250	21	21	21	R1	(46, 55)			
75.4500					(56)	27		
75.4750	22	22	22	R2	(47, 57)			
75.5000	F	F	F	F	F, (48, 58)	28	J	75.5
75.5250	23	23	23	F3	(49, 59)			
75.5500					(60)	29		
75.5750	24	24	24	F4	(50, 61)			
75.6000	S	S		S	S, (62)	30	K	75.6
75.6250	25	25	25	S5	(51, 63)			
75.6500					(64)	31		
75.6750	26	26	26	S6	(52, 65)			
75.7000	G	G	G	G	G, (53, 66)	32	L	75.7
75.7250	27	27	27	G7	(54, 67)			
75.7500					(68)	33		
75.7750	28	28	28	G8	(55, 69)			
75.8000	T	T		T	T, (70)	34	M	75.8
75.8250	29	29	29	T9	(56, 71)			
75.8500					(72)	35		
75.8750	30	30	30	T0	(57, 73)			
75.9000	H	H	H	H	H, (58, 74)	36	N	75.9
75.9250	31	31	31	H1	(59, 75)			
75.9500					(76)	37		
75.9750	32	32	32	H2	(60, 77)			

Wideband frequencies are indicated in highlighted rows. The highlighted channels also indicated those channels available in the "basic" mode (default). All channels can be accessed when in the "expanded" channel mode (see page 8 for more information).

*Parenthesis indicate T35 and T20 narrowband.

216 MHz Compatibility Chart

Frequency MHz	Listen	Phonic Ear	Comtek	Phonak	Williams	Gentner	CSI	AVR
216.0125	1A		1	1				C01
216.0250	2A	41	41	41		1	1	
216.0375	3A		2	2				
216.0625	1B		3	21				
216.0750	2B	42	42	42		2	10	
216.0875	3B		4	4				
216.1125	1C		5	5				C05
216.1250	2C	43	43	43	A	3	6	
216.1375	3C		6	22				
216.1625	1D		7	23				
216.1750	2D	44	44	44	B	4	14	
216.1875	3D		8	8				
216.2125	1E		9	9				C09
216.2250	2E	45	45	45	C	5	2	
216.2375	3E		10	24				
216.2625	1F		11	25				
216.2750	2F	46	46	46	D	6	11	
216.2875	3F		12	12				C12
216.3125	1G		13	13				
216.3250	2G	47	47	47	E	7	7	
216.3375	3G		14	26				
216.3625	1H		15	27				
216.3750	2H	48	48	48	F	8	15	
216.3875	3H		16	16				C18
216.4125	1J		17	17				C21
216.4250	2J	49	49	49	G	9	18	
216.4375	3J		18	18				
216.5125	1K		21	61				
216.5250	2K	51	51	29	H	10	3	
216.5375	3K		22	62				
216.5625	1L		23	28				
216.5750	2L	52	52	52	I	11	12	
216.5875	3L		24	64				C24
216.6125	1M		25	65				C25
216.6250	2M	53	53	53	J	12	8	
216.6375	3M		26	81				
216.6625	1N		27	82				
216.6750	2N	54	54	54	K	13	16	
216.6875	3N		28	68				
216.7125	1P		29	69				C29
216.7250	2P	55	55	55	L	14	19	
216.7375	3P		30	83				
216.7625	1R		31	84				
216.7750	2R	56	56	56		15	4	
216.7875	3R		32	72				C32
216.8125	1S		33	73				C33
216.8250	2S	57	57	57			13	
216.8375	3S		34	76				
216.8625	1T		35	85				
216.8750	2T	58	58	58			9	
216.8875	3T		36	86				
216.9125	1U		37	77				C37
216.9250	2U	59	59	59			17	
216.9375	3U		38	88				

Wideband frequencies are indicated in highlighted rows. The highlighted channels also indicated those channels available in the “basic” mode (default). All channels can be accessed when in the “expanded” channel mode (see page 8 for more information).

Phonak Frequency Chart

Frequency (MHz)	Listen	Phonak
216.012	1A	1
216.025	2A	41
216.037	3A	2
216.062	1B	21
216.075	2B	42
216.088	3B	4
216.113	1C	5
216.125	2C	43
216.137	3C	22
216.162	1D	23
216.175	2D	44
216.188	3D	8
216.213	1E	9
216.225	2E	45
216.238	3E	24
216.262	1F	25
216.275	2F	46
216.287	3F	12
216.312	1G	13
216.325	2G	47
216.338	3G	26
216.363	1H	27
216.375	2H	48
216.387	3H	16
216.412	1J	17
216.425	2J	49
216.438	3J	18
216.512	1K	61
216.525	2K	29
216.537	3K	62
216.562	1L	28
216.575	2L	52
216.588	3L	64
216.613	1M	65
216.625	2M	53
216.637	3M	81
216.662	1N	82
216.675	2N	54
216.688	3N	68
216.713	1P	69
216.725	2P	55
216.738	3P	83
216.762	1R	84
216.775	2R	56
216.787	3R	72
216.812	1S	73
216.825	2S	57
216.838	3S	76
216.863	1T	85
216.875	2T	58
216.887	3T	86
216.912	1U	77
216.925	2U	59
216.938	3U	88
216.963	1V	79
216.975	2V	60
216.988	3V	80

Wideband frequencies are indicated in highlighted rows. The highlighted channels also indicated those channels available in the “basic” mode (default). All channels can be accessed when in the “expanded” channel mode (see page 8 for more information).

LT-800 Troubleshooting

Troubleshooting

The LT-800 has no power

Make sure the LA-207 power supply is connected to a power source and is connected to the jack marked "Power Input". Make sure the POWER button is pressed in.

There is no audio or the audio level is too low

Make sure that your audio source is properly connected to Input 1 and/or Input 2. The Input 1 or Input 2 switches must be in the correct position for the appropriate input level. For example: if you are using the output of a mixer on Input 2, the switch should be in the -10dBu position. If it were to be in the +10dBu position, the level would be too low. Also, check the Input knob to ensure it is properly adjusted. You should be able to see the VU meter deflect on Input 1 or Input 2 corresponding with the input level of the audio source. You can listen to the audio source by connecting a headset to the front panel jack and adjusting the Monitor volume control.

If the level of audio into the transmitter is low and can't be corrected using the level input switches, the audio processor can be turned on to boost the signal (see page 8 to set, page 12 for description of Process Mode).

The audio is distorted

Check to make sure you have the input level select switches in the proper position. You may be providing too much audio level for the input stage to handle. Make sure the SQ mode is set correctly on both the LT-800 and the receivers you are using. If your receivers do not have SQ, make sure the SQ mode is turned off (see page 8).

There is hum in the audio

Make sure you have properly grounded the audio source to the LT-800. Check the connections from the audio source to the LT-800. If you can, try to use a balanced audio source - this will reduce the chance of creating hum. Connect a ground wire from the LT-800 to ground and/or to the ground of the source audio.

There is a tone

The Test Tone button has been pressed (its LED light is on). Push the Test Tone button to turn off the tone.

The Audio Input 1 sounds "tinny"

If you are using an unbalanced audio source, make sure Pin 3 on the XLR or the ring on the 1/4" plug is grounded (see page 9).

I cannot pick up the signal on the receiver

Check to make sure the receiver and the transmitter are using the same frequency band (i.e. 72 MHz or 216 MHz) and that they are on the same channel. Make sure the LT-800 has an antenna connected. Ensure that the receiver has an antenna (for portable products the headset is the receiving antenna).

I can pick up the signal on the receiver, but it sounds like it's not tuned in

Check to make sure the transmitter and receiver are on exactly the same channel. It's a good idea to lock the channels once they have been set. To lock the LT-800, press the UP button for 3 seconds (see page 10).

LT-800 Troubleshooting (cont.)

Troubleshooting

I'm using another brand of receiver - how do I tell which channel to use

Refer to Listen's Frequency Compatibility Tables (pages 15-17). Adjust Listen's transmitter to the same frequency as the other major brand. Since Listen products can access 57 channels, they will most likely receive on the same fixed channel or channels of other major brands. If you are using another brand of receiver, make sure you have turned off the SQ feature on the Listen product(s).

There is not sufficient range

First make sure that the receivers you are using are operating properly, then make sure that you have an antenna connected either to the top of the LT-800 transmitter or connected to the back of the unit (but not both!). The antenna should be as high as possible and free of obstacles. In addition make sure you are using the correct antenna type for your unit. You might want to use a remote antenna (provided by Listen) that can be mounted on a mast or wall. Try using different frequencies to find one with less interference.

There is interference in my transmission

Ensure that the transmitter and receivers are on the same channel. Verify that there are no other transmitters on the same channel or a close channel to the one exhibiting interference. Try different channels until you find a clear channel. If this does not work, try a different frequency band (i.e. if you are using 72 MHz, try 216 MHz or vice versa). Please contact Listen support for assistance and a return authorization (RMA) number to exchange product for alternate frequency equipment.

End users are adjusting the unit

First, lock the channel by pressing and holding the channel select UP button for 3 seconds. Consider removing the Input, Mix Level and Contour knobs. You can order a rack mount kit from Listen which offers a security cover that will limit access to the unit.

I am using other manufacturers' receivers and the sound is distorted

The receiver is probably not designed to handle the +25 kHz deviation of the Listen transmitter. This can be corrected by turning the Mix Level knob down. Another possibility is that you have enabled the SQ function of the LT-800, and this feature is not available in other companies' products. You will need to disable SQ in this event (see page 8).

If you are using Phonak receivers, the transmitter is capable of operating in the Phonak mode (please refer to page 8).

Several transmitters are operating in the same environment

For this, you'll need to choose your transmitting frequencies carefully. See page 15-17 for more details.

Can I have two antennas connected to my transmitter

No. The LT-800 transmitter can use only one antenna connection at a time. You may connect either a top mount antenna through the top antenna port, or a remote antenna connected to the BNC connection on the rear of the unit. If multiple antennae are simultaneously connected to both ports the transmitter will have extremely poor broadcast performance and range.

Compliance Notice & FCC Statement

Compliance Notice

This device complies with part 15 of the FCC Rules. Operation is subject to the following two conditions: (1) These devices may not cause harmful interference, and (2) these devices must accept any interference received, including interference that may cause undesirable operation.

Listen's LT-800 Transmitter (216 MHz only)

Listen's LT-800 transmitter is authorized by rule under the Low Power Radio Service (47 C.F.R. Part 95) and must not cause harmful interference to TV reception or United States Navy SPASUR installations. You do not need an FCC license to operate these transmitters. These transmitters may only be used to provide: auditory assistance to persons with disabilities, persons who require language translation, or persons in educational settings; health care services to the ill; law enforcement tracking services under agreement with a law enforcement agency; or automated maritime telecommunications system (AMTS) network control communications. Two-way voice communications and all other types of uses not mentioned above are expressly prohibited.

This device must be installed by a trained audio professional or certified dealer of Listen. The user can't make any modifications to the unit without expressed written consent of Listen Technologies Corporation. Any modifications made will void the FCC compliance, Listen warranty and the users authority to operate Listen's equipment.

FCC Statement

This equipment has been tested and found to comply with the limits for a class B digital device, pursuant to part 15 of the FCC Rules. These limits are designed to provide reasonable protection against harmful interference in a residential installation. This equipment generates, uses and can radiate radio frequency energy and if not installed and used in accordance with the instructions, may cause harmful interference to radio communications. However, there is no guarantee that interference will not occur in a particular installation. If this equipment does cause harmful interference to radio or television reception, which can be determined by turning the equipment off and on, the user is encouraged to try to correct the interference by one or more of the following measures:

- Reorient or relocate the receiving antenna.
- Increase the separation between the equipment and receiver.
- Connect the equipment into an outlet on a circuit different from that to which the receiver is connected.
- Consult the dealer or an experienced radio/TV technician for help.

This equipment has been certified to comply with the limits for a class B computing device, pursuant to FCC and IC Rules. In order to maintain compliance with FCC and IC regulations, shielded cables must be used with this equipment. Operation with non-approved equipment or unshielded cables is likely to result in interference to radio and TV reception. The user is cautioned that changes and modifications made to the equipment without the approval of manufacturer could void the user's authority to operate this equipment.

Warranty & Contacting Listen

Warranty

Listen Technologies Corporation (Listen) warrants its transmitters and receivers (LT-82, LT-700, LT-800, LR-100, LR-42, LR-44, LR-300, LR-400, LR-500, LR-600) to be free from defects in workmanship and material under normal use and conditions for the useful lifetime of the product from date of purchase.

Listen warrants its Stationary IR Radiators (LA-140) to be free from defects in workmanship and material under normal use and conditions for three years from the date of purchase.

Listen warrants its Noise Canceling Microphone (LA-270) to be free from defects in workmanship and material under normal use and conditions for one year from date of purchase.

Listen warrants its Charging/Carrying Cases (LA-306, LA-311, LA-313, LA-317, LA-318, LA-319, LA-320, LA-321, LA-322, LA-323, LA-324, LA-325) to be free from defects in workmanship and material under normal use and conditions for one year from date of purchase.

All other products and accessories are warranted for 90 days from date of purchase.

This warranty is only available to the original end purchaser of the product and cannot be transferred. Warranty is only valid if warranty card has been returned within 90 days of purchase. This warranty is void if damage occurred because of misuse or if the product has been repaired or modified by anyone other than a factory authorized service technician. Warranty does not cover normal wear and tear on the product or any other physical damage unless the damage was the result of a manufacturing defect. Listen is not liable for consequential damages due to any failure of equipment to perform as intended. Listen shall bear no responsibility or obligation with respect to the manner of use of any equipment sold by it. Listen specifically disclaims and negates any warranty of merchantability or fitness of use of such equipment including, without limitation, any warranty that the use of such equipment for any purpose will comply with applicable laws and regulations. The terms of the warranty are governed by the laws of the state of Utah.

In the first ninety days after purchase, any defective product will be replaced with a new unit. After 90 days, Listen will, at its own discretion either repair or replace transmitters and receivers with a new unit or a unit of similar type and condition. Product that is not covered under warranty shall be repaired or replaced with a unit of similar type and condition based on a flat fee. Contact Listen for details.

This limited warranty, prices and the specifications of products are subject to change without notice.

Contacting Listen

If technical service is needed, please contact Listen. Pre-authorization is required before returning Listen products. If products were damaged in shipment, please contact the carrier, then contact Listen for replacement or repair requirements payable by the carrier.

Listen's corporate headquarters are located in Bluffdale, Utah U.S.A. and are open Monday through Friday, 8am to 5pm Mountain Time.

14912 Heritagecrest Way
Bluffdale, Utah 84065-4818
+1.801.233.8992
+1.800.330.0891 North America
+1.801.233.8995 fax

support@listentech.com
www.listentech.com

Listen Technologies GmbH
Jasminstr.16, 90522 Oberasbach, Germany
+49 911 955 159 0 Europe
+49 911 955 159 40 Fax
support@listentech.de
www.listentech.de

Optional Accessories

Antenna Accessories



LA-101
Helical Top Mounted Antenna
(72 MHz)



LA-102
Telescoping Top Mounted
Antenna (216 MHz)



LA-106
Telescoping Top Mounted
Antenna (72 MHz)

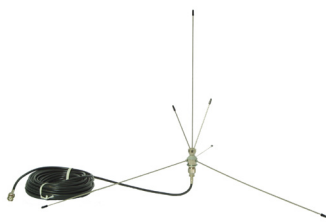

LA-107
Ground Plane Remote Antenna
(216 MHz)

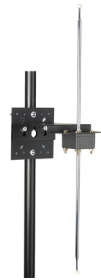

LA-122
Universal Antenna Kit
The single solution for all of
your indoor remote antenna
needs. Includes: 72 and 216 MHz
components; flexible and rigid
dipoles and monopole radials;
hardware for multiple mount-
ing configurations; and 25 feet
(7.6m) of RG-58 coax cable.



LA-123
90° Helical Antenna
(72 MHz)



LA-124
90° Helical Antenna
(216 MHz)

LT-800 Rack Mount Accessories



LA-125 (72 MHz) and LA-126 (216 MHz)
Antenna Kit for Rack Mount



LA-326
Universal Rack Mounting Kit
Includes components for single and dual rack
configuration and a security cover
**NOTE: Rack mounted units cannot use the LA-106,
LA-102 or LA-101 top mounted antenna.**

Optional Accessories (cont.)

Cable & Connectors Accessories



LA-112
RG-58 50 Ohm
Coaxial Cable (per ft.)



LA-113
RG-8 50 Ohm Low-Loss
Coaxial Cable (per ft.)



LA-127
RG-58 BNC Connector



LA-128
RG-8 BNC Connector



LA-390
RG-8 50 Ohm Preassembled
Coaxial Cable (per ft.)



LA-391
RG-58 50 Ohm Preassembled
Coaxial Cable (per ft.)

Microphone Accessories



LA-261
Lavalier Microphone



LA-262
Over-the-Head
Microphone



LA-270
Noise Canceling
Microphone



LA-274
Hand-Held
Microphone



LA-276
Collar
Microphone



LA-277
Conferencing
Microphone



LA-278
Behind-the-Head
Microphone



LA-279
Over-the-Ear Microphone
Presentation Style

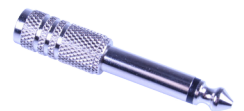

LA-280
¼ in. to 3.5 mm
Microphone
Adapter for
LT-800/LT-82

NOTE: To use Listen microphones you must use a converter (LA-280) to adapt the 3.5 mm connection to a 1/4" phono connection.

Notes

Notes

Notes

Notes



Listen Technologies Corporation
14912 Heritagecrest Way
Bluffdale, Utah 84065-4818, U.S.A.
+1.801.233.8992
+1.800.330.0891 North America
+1.801.233.8995 fax

www.listentech.com