

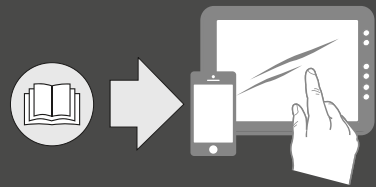

# K 6 K 6-P

Quick Guide	Kort vejledning
Kurzanleitung	Pikaohje
Guide de démarrage rapide	Γρήγορος οδηγός
Guida rapida	Kısa Kılavuz
Instrucciones resumidas	Краткая инструкция
Instruções resumidas	快速指南
Beknopte gebruiksaanwijzing	快速使用指南
Krótko instrukcja obsługi	クイックガイド
Snabbguide	퀵 가이드

**SENNHEISER**



**Sennheiser Documentation App**



or online at  
[www.sennheiser.com/download](http://www.sennheiser.com/download)

Q K 6\_

Sennheiser electronic GmbH & Co. KG

Am Labor 1, 30900 Wedemark, Germany  
[www.sennheiser.com](http://www.sennheiser.com)

Printed in Germany, Publ. 08/19, 583977/A01

## In the box

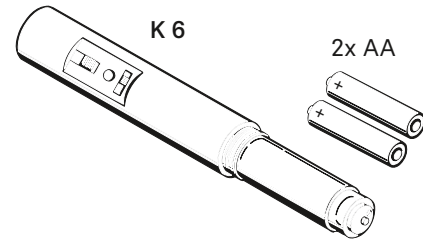

OR

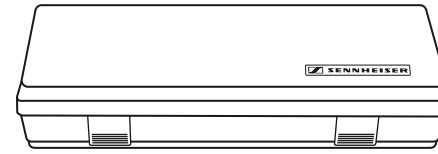
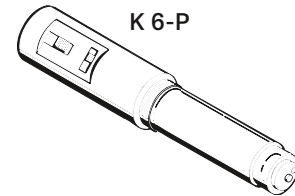

## Overview

K 6

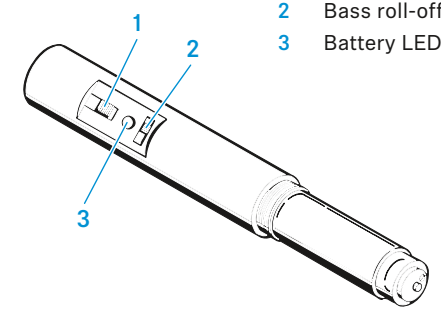

- 1 On/off
- 2 Bass roll-off filter
- 3 Battery LED

K 6-P

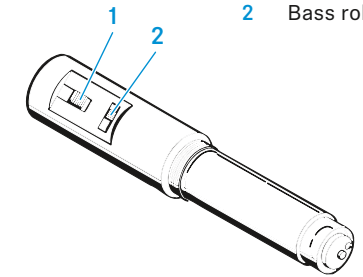

- 1 On/off
- 2 Bass roll-off filter

## Setup

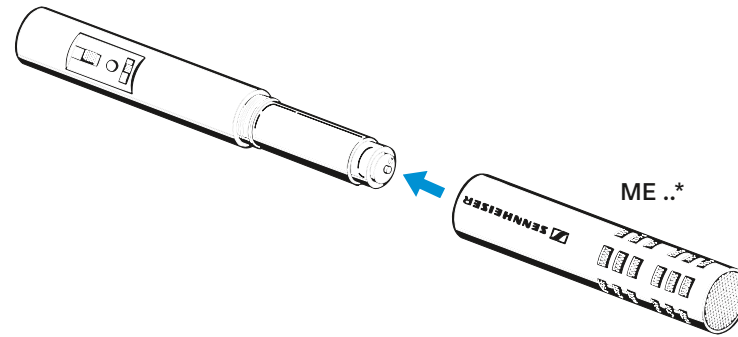

ME ..\*

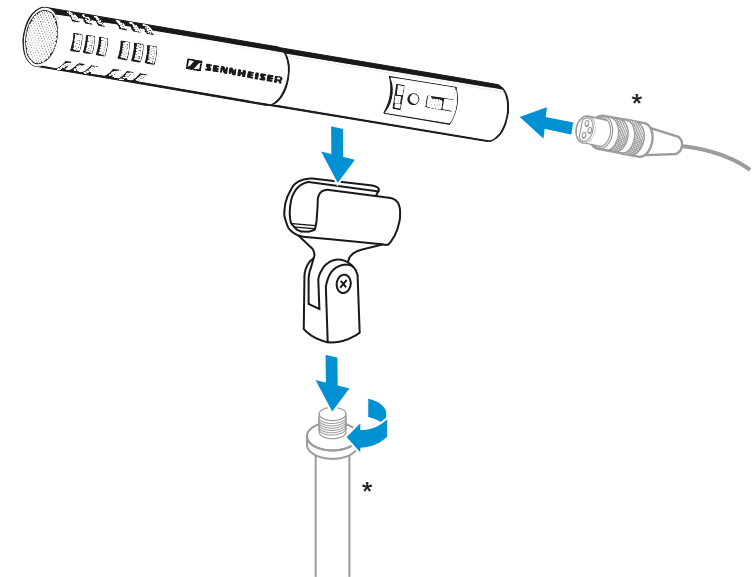

\* not included

### On/Off

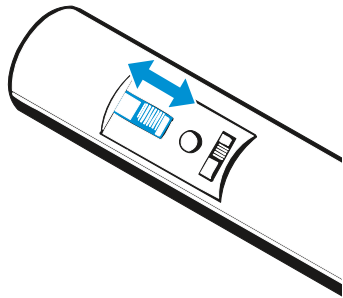

### Bass roll-off filter

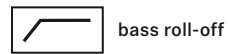
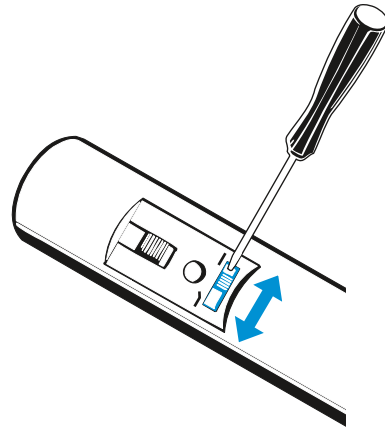

### Specifications

Electrical impedance	approx. 200 $\Omega$ (bal.), approx. 100 $\Omega$ (unbal.)
Min. terminating impedance	1 k $\Omega$
Sensitivity (at 1 kHz)	0 dB
Current consumption	2.2 mA
Max. output voltage (no load)	2 V (corresponds to 6 dBV)
Phantom power	12 - 48 V $\overline{\text{---}}$ , 2 mA
Power supply battery (K 6 only)	1.5 V
Battery operating time (K 6 only)	max. 150 h
Connector	XLR-3
Dimensions	K 6: $\varnothing$ 22 x 94 mm K 6-P: $\varnothing$ 22 x 52 mm
Weight	K 6: 45 g (without battery) K 6-P: 30 g

### Battery LED

K 6

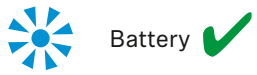
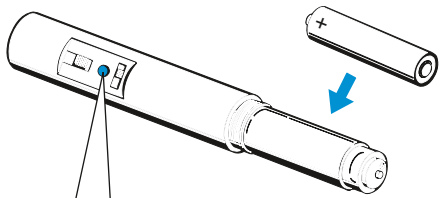

### Cleaning

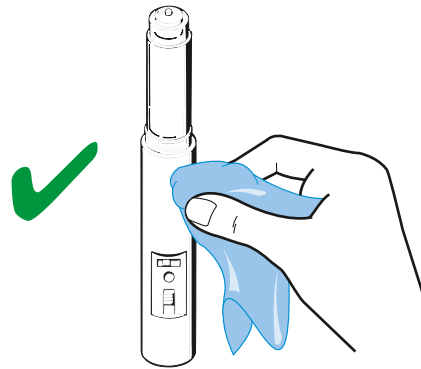

### Frequency response

