

Zoom lens

Description

This zoom lens is designed for use with a Panasonic's applicable projector. The lens makes it possible to vary the projection distance by changing the focal distance.

NOTE: Please use the lens only on the specified Panasonic projectors.

Specifications

F value:	1.8 – 2.3
Focal distance (f):	45.6 mm – 73.8 mm
Throw ratio:	WUXGA 2.8 - 4.6:1 for PT-MZ770/MZ670/MZ570/EZ770Z (16:10 aspect ratio) WXGA 2.8 - 4.6:1 for PT-MW730/MW630/MW530/EW730Z (16:10 aspect ratio) XGA 2.8 - 4.6:1 for PT-EX800Z (4:3 aspect ratio)
Dimensions (W × H × D):	108 × 108 × 197*1 mm (4-1/4 × 4-1/4 × 7-3/4*1 inches)
Weight:	Approx. 1.18 kg*2 (2.6 lbs*2)
Applicable projector:	[GROUP A] PT-EZ770Z series: PT-EZ770Z/EZ770ZL/EW730Z/EW730ZL/EX800Z/EX800ZL [GROUP B] PT-MZ670series: PT-MZ670/MZ670L/MZ570/MZ570L/MW630/MW630L/MW530/MW530L PT-MZ770series: PT-MZ770/MZ770L/MW730/MW730L

*1 At maximum length.

*2 Average value. May differ depending on the actual unit.

The throw ratio is an approximate value calculated by dividing the screen width by the projection distance.

Dimensions

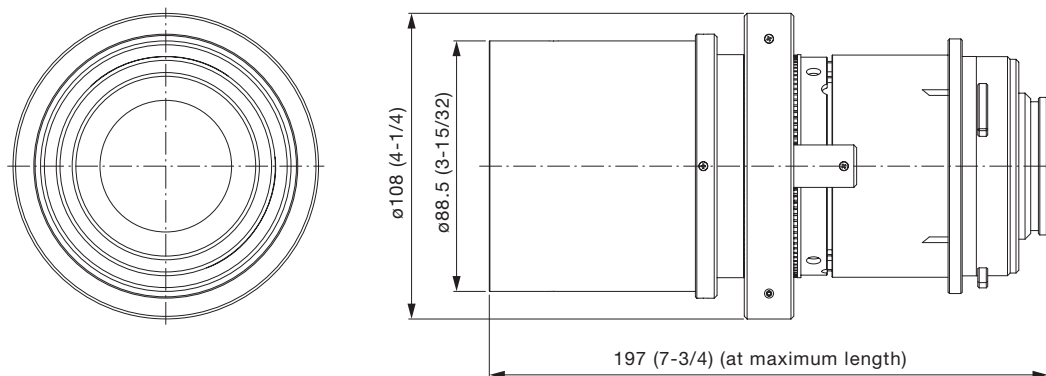

NOTE: Please read the projector's instruction manual for throw distances.
Weights and dimensions shown are approximate. Specifications subject to change without notice.

unit : mm (inch)
NOTE: This illustration is not drawn to scale.

Zoom lens

The illustration shows the lens attached to the projector.

[GROUP A]

PT-EZ770Z series: PT-EZ770Z/EZ770ZL/EW730Z/EW730ZL/EX800Z/EX800ZL

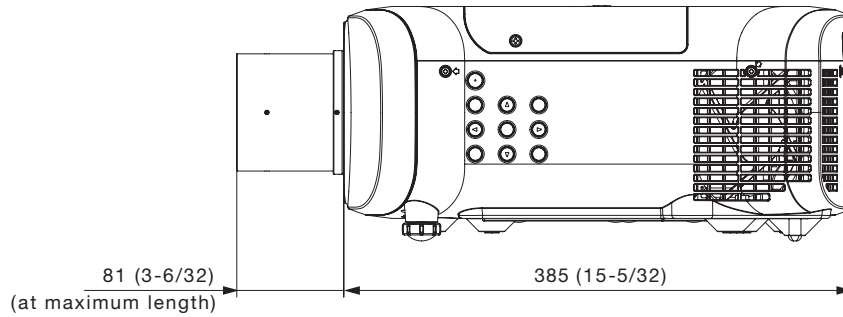

[GROUP B]

PT-MZ670 series: PT-MZ670/MZ670L/MZ570/MZ570L/MW630/MW630L/MW530/MW530L

PT-MZ770 series: PT-MZ770/MZ770L/MW730/MW730L

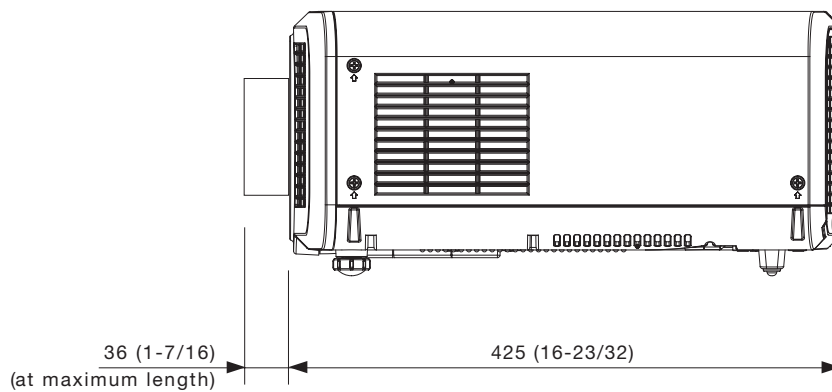

NOTE: Please read the projector's instruction manual for throw distances.
Weights and dimensions shown are approximate. Specifications subject to change without notice.

unit : mm (inch)
NOTE: This illustration is not drawn to scale.