

LCD Digital Color TV

Operating Instructions

BRAVIA

KDL-V26XBR1

KDL-V32XBR1

KDL-V40XBR1

XBR

Owner's Record

The model and serial numbers are located at the rear of the LCD TV, below the Sony logo, on the sticker, and also on the TV box (white label). Record these numbers in the spaces provided below. Refer to them whenever you call upon your Sony dealer regarding this product.

Model No. _____

Serial No. _____

Contacting Sony

If, after reading the following instructions, you have additional questions related to the use of your Sony® TV, Please call one of the following numbers.

Customers in the continental United States contact the Direct Response Center at:

1-800-222-SONY (7669)

Customers in Canada contact the Customer Relations Center at:

1-877-899-SONY (7669)

WARNING

To reduce the risk of fire or electric shock, do not expose this apparatus to rain or moisture.

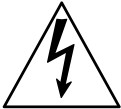

This symbol is intended to alert the user to the presence of uninsulated “dangerous voltage” within the product’s enclosure that may be of sufficient magnitude to constitute a risk of electric shock to persons.



This symbol is intended to alert the user to the presence of important operating and maintenance (servicing) instructions in the literature accompanying the appliance.

The apparatus shall not be exposed to dripping or splashing and no objects filled with liquids, such as vases, shall be placed on the apparatus.

CAUTION

To prevent electric shock, do not use this polarized AC plug with an extension cord, receptacle or other outlet unless the blades can be fully inserted to prevent blade exposure.

Note on Caption Vision

This TV provides display of TV closed captioning in accordance with §15.119 of the FCC rules.

For Customers in the United States

If you have any questions about this product, you may call: Sony Customer Information Services Center 1-800-222-7669 or <http://www.sony.com/>

Declaration of Conformity

Trade Name: SONY
Model: KDL-V26XBR1/KDL-V32XBR1/
KDL-V40XBR1
Responsible Party: Sony Electronics Inc.
Address: 16450 W. Bernardo Dr,
San Diego, CA 92127 U.S.A.
Telephone Number: 858-942-2230

This device complies with part 15 of the FCC rules. Operation is subject to the following two conditions: (1) This device may not cause harmful interference, and (2) this device must accept any interference received, including interference that may cause undesired operation.

NOTIFICATION

This equipment has been tested and found to comply with the limits for a Class B digital device, pursuant to Part 15 of the FCC Rules. These limits are designed to provide reasonable protection against harmful interference in a residential installation. This equipment generates, uses and can radiate radio frequency energy and, if not installed and used in accordance with the instructions, may cause harmful interference to radio communications. However, there is no guarantee that interference will not occur in a particular installation. If this equipment does cause harmful interference to radio or television reception, which can be determined by turning the equipment off and on, the user is encouraged to try to correct the interference by one or more of the following measures:

- Reorient or relocate the receiving antenna.
- Increase the separation between the equipment and receiver.
- Connect the equipment into an outlet on a circuit different from that to which the receiver is connected.
- Consult the dealer or an experienced radio/TV technician for help.

You are cautioned that any changes or modifications not expressly approved in this manual could void your authority to operate this equipment.

For Customers in Canada

This Class B digital apparatus complies with Canadian ICES-003.

Safety

- Operate the TV only on 120-240 V AC.
- Use the AC power cord specified by Sony and suitable for the voltage where you use it.
- The plug is designed, for safety purposes, to fit into the wall outlet only one way. If you are unable to insert the plug fully into the outlet, contact your dealer.

- If any liquid or solid object should fall inside the cabinet, unplug the TV immediately and have it checked by qualified service personnel before operating it further.
- If you will not be using the TV for several days, disconnect the power by pulling the plug itself. Never pull on the cord.
- For details concerning safety precautions, see “Important Safety Instructions” on page 4 and “Important Safeguards” on page 5.

Installing

- The TV should be installed near an easily accessible power outlet.
- To prevent internal heat buildup, do not block the ventilation openings.
- Do not install the TV in a hot or humid place, or in a place subject to excessive dust or mechanical vibration.
- Avoid operating the TV at temperatures below 41°F (5°C).
- If the TV is transported directly from a cold to a warm location, or if the room temperature changes suddenly, the picture may be blurred or show poor color due to moisture condensation. In this case, please wait a few hours to let the moisture evaporate before turning on the TV.
- To obtain the best picture, do not expose the screen to direct illumination or direct sunlight. It is recommended to use spot lighting directed down from the ceiling or to cover the windows that face the screen with opaque drapery. It is desirable to install the TV in a room where the floor and walls are not of a reflective material.

CAUTION

Use the following Sony appliance(s) only with the following WALL-MOUNT BRACKET.

Use with other WALL-MOUNT BRACKET may cause instability and possibly result in injury.

SONY APPLIANCE MODEL NO.

KDL-V26XBR1

KDL-V32XBR1

KDL-V40XBR1

SONY WALL-MOUNT BRACKET MODEL NO.

SU-WL31 (KDL-V26XBR1/KDL-V32XBR1)

SU-PW2 (KDL-V40XBR1)

To Customers

Sufficient expertise is required for installing the specified product. Be sure to subcontract the installation to Sony dealers or licensed contractors and pay adequate attention to safety during the installation.

(Continued)

For Customers in the United States

This product contains mercury. Disposal of this product may be regulated if sold in the United States. For disposal or recycling information, please contact your local authorities or the Electronics Industries Alliance (<http://www.eiae.org>).

To Sony Dealers

For installation of SONY WALL-MOUNT BRACKET, be sure to read and follow the instructions supplied with those optional products.

Note

This digital television is capable of receiving analog basic, digital basic and digital premium cable television programming by direct connection to a cable system providing such programming. A security card provided by your cable operator is required to view encrypted digital programming. Certain advanced and interactive digital cable services such as video-on-demand, a cable operator's enhanced program guide and data-enhanced television services may require the use of a set-top box. For more information call your local cable operator.

This television also includes a QAM demodulator which should allow you to receive unscrambled digital cable television programming via subscription service to a cable service provider. Availability of digital cable television programming in your area depends on the type of programming and signal provided by your cable service provider.

Trademark Information

CableCARD™ is a trademark of Cable Television Laboratories, Inc.

TruSurround XT, SRS 3D Mono and the  symbol are trademarks of SRS Labs, Inc. TruSurround XT and SRS 3D Mono technologies are incorporated under license from SRS Labs, Inc.

Licensed by BBE Sound, Inc. under USP4638258, 4482866. "BBE" and BBE symbol are trademarks of BBE Sound, Inc.

Macintosh is a trademark licensed to Apple Computer, Inc., registered in the U.S.A and other countries.

WEGA, WEGA GATE, Steady Sound, Digital Reality Creation and CineMotion are registered trademarks of Sony Corporation.

"PlayStation" is a trademark of Sony Computer Entertainment, Inc.



CompactFlash is a trademark of SanDisk Corporation.



Manufactured under license from Dolby Laboratories. "Dolby" and the double-D symbol are trademarks of Dolby Laboratories.

 This TV incorporates High-Definition Multimedia Interface (HDMI™) technology. HDMI, the HDMI logo and High-Definition Multimedia Interface are trademarks or registered trademarks of HDMI Licensing LLC.

Important Safety Instructions

- 1) Read these instructions.
 - 2) Keep these instructions.
 - 3) Heed all warnings.
 - 4) Follow all instructions.
 - 5) Do not use this apparatus near water.
 - 6) Clean only with dry cloth.
 - 7) Do not block any ventilation openings. Install in accordance with the manufacturer's instructions.
 - 8) Do not install near any heat sources such as radiators, heat registers, stoves, or other apparatus (including amplifiers) that produce heat.
- 
- 9) Do not defeat the safety purpose of the polarized or grounding-type plug. A polarized plug has two blades with one wider than the other. A grounding type plug has two blades and a third grounding prong. The wide blade or the third prong are provided for your safety. If the provided plug does not fit into your outlet, consult an electrician for replacement of the obsolete outlet.
- 10) Protect the power cord from being walked on or pinched particularly at plugs, convenience receptacles, and the point where they exit from the apparatus.
 - 11) Only use attachments/accessories specified by the manufacturer.
 - 12) Use only with the cart, stand, tripod, bracket, or table specified by the manufacturer, or sold with the apparatus. When a cart is used, use caution when moving the cart/apparatus combination to avoid injury from tip-over.
- 
- 13) Unplug this apparatus during lightning storms or when unused for long periods of time.
 - 14) Refer all servicing to qualified service personnel. Servicing is required when the apparatus has been damaged in any way, such as power-supply cord or plug is damaged, liquid has been spilled or objects have fallen into the apparatus, the apparatus has been exposed to rain or moisture, does not operate normally, or has been dropped.

Important Safeguards

Before using your TV, please read these instructions completely, and keep this manual for future reference.

Carefully observe and comply with all warnings, cautions and instructions placed on the unit or described in the operating instructions or service manual.

WARNING

To guard against injury, the following basic safety precautions should be observed in the installation, use and servicing of the unit.

Use

Power Sources

This unit should be operated only from the type of power source indicated on the information label. If you are not sure of the type of electrical power supplied to your home, consult your dealer or local power company.

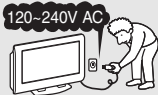

Grounding or Polarization

This unit is equipped with a polarized AC power cord plug (a plug having one blade wider than the other), or with a three-wire grounding type plug (a plug having a third pin for grounding). Follow the instructions below:

For the unit with a three-wire grounding type AC power cord plug (Class 1 unit)

This unit must be connected to an AC power socket outlet with a protective earthing connection.



For the unit with a polarized AC power cord plug

This plug will fit into the power outlet only one way. This is a safety feature. If you are unable to insert the plug fully into the outlet, try reversing the plug.



If the plug still fails to fit, contact your electrician to have a suitable outlet installed. Do not defeat the safety purpose of the polarized plug by forcing it in.

Wall outlet

Do not use a poor fitting outlet.

Insert the plug fully into the outlet. If it is loose, it may cause arcing and result in fire.

Contact your electrician to have the outlet changed.



Wiring

For your safety, unplug the AC power cord when wiring cables.

Electric shock

Do not touch the AC power cord or the unit with a wet hand. If you plug/unplug the AC power cord from the unit with a wet hand, it may cause electric shock.



Cleaning

- Clean the AC power plug regularly. If the plug is covered with dust and it picks up moisture, its insulation may deteriorate and result in fire. Unplug the AC power plug and clean it regularly.



- Unplug the AC power cord when cleaning this unit. If not, it may result in electric shock.
- Clean the cabinet of the TV with a dry soft cloth. To remove dust from the screen, wipe it gently with a soft cloth. Stubborn stains may be removed with a cloth slightly dampened with a solution of mild soap and warm water. Never use strong solvents such as thinner or benzene for cleaning.
- If using a chemically pretreated cloth, please follow the instruction provided on the package.
- If the picture becomes dark after using the TV for a long period of time, it may be necessary to clean the inside of the TV. Consult qualified service personnel.



Overloading

Do not overload wall outlets, extension cords or convenience receptacles beyond their capacity, since this can result in fire or electric shock.



Power

Always turn the unit off when it is not being used. When the unit is left unattended and unused for long periods of time, unplug it from the wall outlet as a precaution against the possibility of an internal malfunction that could create a fire hazard.



Sound

If a snapping or popping sound from the TV is continuous or frequent while the TV is operating, unplug the TV and consult your dealer or service technician. It is normal for TV's to make occasional snapping or popping sounds, particularly when being turned on or off.



AC Power Cord

If you damage the AC power cord, it may result in fire or electric shock.

- Do not pinch, bend, or twist the cord excessively. The core lines may be bared and cut, and cause short-circuit, resulting in fire or electric shock.
 - Do not convert or damage the AC power cord.
 - Do not put anything heavy on the AC power cord. Do not pull the AC power cord.
 - Keep the AC power cord away from heat sources.
 - Be sure to grasp the plug when disconnecting the AC power cord.
- If the AC power cord is damaged, stop using it and ask your dealer or Sony service center to exchange it.

Batteries

Do not dispose of batteries in a fire.

Do not short circuit, disassemble or overheat the batteries.

Disposal of used batteries

To preserve our environment, dispose of used batteries according to your local laws or regulations.

Ventilation holes

Never push objects of any kind into the unit through the cabinet slots as they may touch dangerous voltage points or short out parts that could result in a fire or electric shock. Never spill liquid of any kind on the unit.



Objects and Liquid Entry

Do not place any objects on the unit.

The apparatus shall not be exposed to dripping or splashing and no objects filled with liquids, such as vases, shall be placed on the apparatus.



(Continued)

Attachments

Do not use attachments not recommended by the manufacturer, as they may cause hazards.

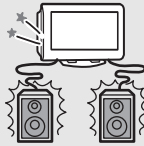

Medical institution

Do not place this unit in a place where medical equipment is in use.

It may cause malfunction of medical instruments.



Moisture and flammable objects

Do not use plugged sets near water — for example, near a bathtub, washbowl, kitchen sink, or laundry tub, in a wet basement, or near a swimming pool, etc. It may result in fire or electric shock.



Do not let this unit get wet. Never spill liquid of any kind on the unit. If any liquid or solid object does fall through, do not operate the unit. It may result in electric shock or damage to the unit. Have it checked immediately by qualified personnel.



To prevent fire, keep flammable objects or open flame (e.g. candles) away from the unit.

Accessories

Do not place the unit on an unstable cart, stand, table or shelf. The unit may fall, causing serious injury to a child or an adult and serious damage to the unit. No part of the TV should overhang any edge of the TV cart or stand; any overhanging edge is a safety hazard. An appliance and cart combination should be moved with care. Quick stops, excessive force, and uneven surfaces may cause the appliance and cart combination to overturn.



Broken pieces

Do not throw anything at the unit.

The screen glass may break by the impact and cause serious injury.

Cable wiring

Take care not to catch your feet on the cables. It may damage the unit.

Heat

Do not touch the surface of the TV.

It remains hot, even for some time after the TV is turned off.

Volume adjustment

- Adjust the volume so as not to trouble your neighbors. Sound carries very easily at night time. Therefore, closing the windows or using headphones is suggested.
- When using headphones, adjust the volume so as to avoid excessive levels, as hearing damage may result.

Disposal of the TV

- Do not dispose the TV with general household waste.
- The LCD contains a small amount of liquid crystal. The fluorescent tube used in this display contains mercury. Follow your local ordinances and regulations for disposal.

Handling of broken glass and liquid crystal leakage

If the LCD panel gets damaged, crystalline liquid leakage may occur, or scattered broken glass may result. Do not touch broken glass or crystalline liquid (which is toxic), with bare hands as cuts or poisoning/skin irritation may occur. Also, do not let glass fragments or leaked crystalline liquid get into your eyes or mouth. Should either contact your eyes or mouth, rinse the contacted area thoroughly with water and consult your doctor.

LCD screen

- Although the LCD screen is made with high-precision technology and has effective pixels of 99.99% or more, black dots may appear or bright points of light (red, blue, or green) may appear constantly on the LCD screen. This is a structural property of the LCD panel and is not a malfunction.
- Do not expose the LCD screen surface to the sun. Doing so may damage the screen surface.
- Do not push or scratch the LCD screen, or place objects on top of the TV. The image may be uneven or the LCD panel may be damaged.
- If the TV is used in a cold place, a smear may occur in the picture or the picture may become dark. This does not indicate a failure. These phenomena improve as the temperature rises.
- Ghosting may occur when still pictures are displayed continuously. It may disappear after a few moments.
- The screen and cabinet get warm when the TV is in use. This is not a malfunction.
- Avoid spraying insect repellent with volatile material to the screen.
- Avoid prolonged contact with rubber or plastic made material.

Fluorescent lamp

This TV uses a special fluorescent lamp as its light source. If the screen image becomes dark, flickers, or does not appear, the fluorescent lamp has run down and should be replaced. For replacement, consult qualified service personnel.

Installation and moving

Carry the TV in the specified manner

Carrying the TV requires at least two people.

If you carry the TV in a manner other than that specified and without the specified number of persons, it may drop and a serious injury may result. Be sure to follow the instructions given below.

- Carry the TV with the specified number of persons.
- Carry the TV holding the upper and bottom frames of the TV as illustrated.
- Hold the TV securely when carrying it.
- As the glass surface of the TV has a special coating, be careful to avoid touching the glass surface as far as possible.
- When transporting, do not subject the unit to shocks or vibration, or excessive force.



Installation

- When installing or removing the TV on the wall, be sure to use qualified contractors. Wall mount installation requires the use of a wall-mount bracket. If the TV is installed or removed from the wall by a person other than a qualified contractor, the unit may fall and cause serious injury if the unit is not installed securely.
- To prevent injury, this apparatus must be securely attached to the stand/wall in accordance with the installation instructions.

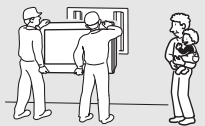

Placement for viewing

It is recommended to watch the TV at a distance of 3 to 7 times that of the screen height, and in moderate brightness. Watching the TV for too long or in a dark room will cause eye fatigue.

Optional accessories

Observe the following when installing the TV using a wall-mount bracket. If the TV is not secured properly, it may fall and cause injury.

- Be sure to follow the operating instructions supplied with the wall-mount bracket when installing the unit.
- Be sure to attach the brackets supplied with the wall-mount bracket.



Protruding location

Do not install the TV in protruding locations. If you install the unit in the following locations, injury may result.

- Do not install the unit in a location where the unit protrudes, such as pillars.
- Do not install the unit in a location that may cause injury.

Oils

Do not install this unit in restaurants where oily vapors occur. Dust absorbing oil may enter into the unit and damage the unit.

Corrosion

Use of this TV near the seashore may subject the set to excessive salt, corrosion and internal damage and result in deterioration of the TV's performance. If the set will be subjected to these conditions, steps should be taken to reduce the humidity and temperature of the area where the TV is located.

Ventilation

The slots and openings in the TV are provided for necessary ventilation. To ensure reliable operation of the unit, and to protect it from overheating, these slots and openings must never be blocked or covered.

Unless proper ventilation is provided, the unit may gather dust and get dirty. For proper ventilation, observe the following:

- Do not install the unit turned backward or sideways.
- Do not install the unit turned over or upside down.
- Never cover the slots and openings with a cloth or other materials.



- Never block the slots and openings by placing the unit on a bed, sofa, rug or other similar surface.



- Never place the unit in a confined space, such as a bookcase or built-in cabinet, unless proper ventilation is provided.

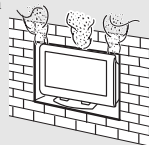

- Leave some space around the unit. Otherwise, adequate air-circulation may be blocked causing overheating and cause fire or damage the unit.

When installing the unit on the wall, allow this much space.

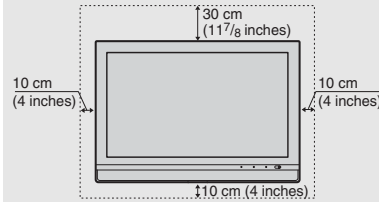

When installing the unit using a stand, allow this much space.

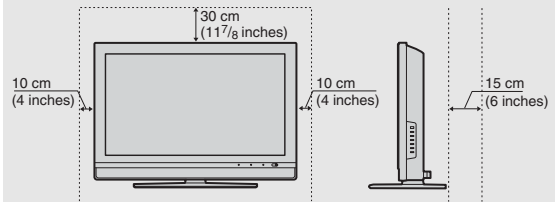

Never install the unit as follows:

Air circulation is blocked.

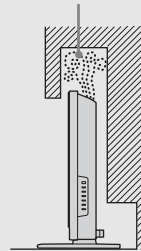

Air circulation is blocked.

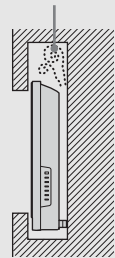

Outdoor use

Do not install this unit outdoors. If the unit is exposed to rain, it may result in fire or electric shock. If the unit is exposed to direct sunlight, the unit may heat up and cause damage to the unit.

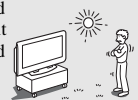

Vehicle and ceiling

Do not install this unit in a vehicle or hang from the ceiling.

Bumping of the vehicle may cause the unit to fall down and cause injury.



Ship and vessel

Do not install this unit in a ship or vessel. If the unit is exposed to seawater, it may cause fire or damage the unit.



(Continued)

Preventing the TV from toppling over

Take measures to prevent the unit from toppling over and causing injury. To prevent the unit from toppling over, secure the unit to the wall or pillar.

Installing on a level surface

If you install the unit on a non-level surface, the unit may fall or drop and cause injury or damage.



Placing on a stable surface

If you place the unit on an unstable surface, the unit may fall and cause injury or damage.



Fall

Do not hang anything on the unit.

The unit may fall from the stand or wall-mount bracket, causing damage or serious injury.



AC power cord

Unplug the AC power cord when moving the unit.

Do not move the unit with the AC power cord plugged in. It may damage the AC power cord and result in fire or electric shock.

Do not allow anything to rest on or roll over the power cord, and do not place the unit where the power cord is subject to wear or abuse.



Antennas

Outdoor Antenna Grounding

If an outdoor antenna is installed, follow the precautions below. An outdoor antenna system should not be located in the vicinity of overhead power lines or other electric light or power circuits, or where it can come in contact with such power lines or circuits.

WHEN INSTALLING AN OUTDOOR ANTENNA SYSTEM, EXTREME CARE SHOULD BE TAKEN TO KEEP FROM CONTACTING SUCH POWER LINES OR CIRCUITS AS CONTACT WITH THEM IS ALMOST INVARIABLY FATAL.

Be sure the antenna system is grounded so as to provide some protection against voltage surges and built-up static charges.

Section 810 of the National Electrical Code (NEC) in USA and Section 54 of the Canadian Electrical Code in Canada provides information with respect to proper grounding of the mast and supporting structure, grounding of the lead-in wire to an antenna discharge unit, size of grounding conductors, location of antenna discharge unit, connection to grounding electrodes, and requirements for the grounding electrode.

Antenna Grounding According to the National Electrical Code, ANSI/NFPA 70

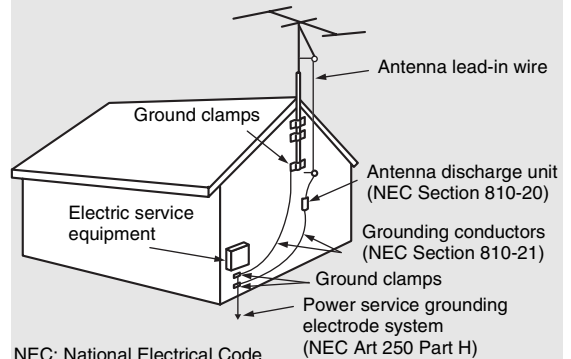

Lightning

For added protection for this TV during a lightning storm, or when it is left unattended and unused for long periods of time, unplug it from the wall outlet and disconnect the antenna. This will prevent damage to the receiver due to lightning and power-line surges.

Service

Damage Requiring Service

Do not attempt to service the set by yourself since opening the cabinet may expose you to dangerous voltage or other hazards.

Unplug the set from the wall outlet and refer servicing to qualified service personnel.



Replacement parts

When replacement parts are required, be sure the service technician certifies in writing that he/she has used replacement parts specified by the manufacturer that have the same characteristics as the original parts.

Unauthorized substitutions may result in fire, electric shock or other hazards.



Safety check

Upon completion of any service or repairs to the unit, ask the service technician to perform routine safety checks (as specified by the manufacturer) to determine that the unit is in safe operating condition, and to so certify. Ask a qualified service technician to dispose of the unit.



Contents

Introducing the TV

Welcome	11
Package Contents.....	11
Features.....	11
Installing the TV	13
Preventing the TV from Toppling Over	13
Bundling the Connecting Cables.....	14
Adjusting the Viewing Angle of the TV.....	14
TV Controls and Connectors	15
Front Panel	15
Side Panel.....	16
Rear Panel.....	17

Connecting the TV

Overview	19
Making Video and Audio Connections	19
About Using S VIDEO.....	20
About Using HDMI to DVI Adapter.....	20
Basic Connections	21
Cable System or VHF/UHF.....	21
Cable Box and Antenna	22
Cable Box	23
Satellite Receiver	24
Digital Cable Box or Digital Satellite Receiver.....	25
Equipment with HDMI Connection	26
Equipment with DVI Connection	27
Equipment with Digital Audio (OPTICAL)	28
Using CableCARD Device	29
About Using CableCARD Device.....	29
Activating CableCARD Service.....	29
Removing the CableCARD Device	30
Setting Up the Channel List	31
Using Initial Setup	31
Connecting Optional Equipment	32
VCR and Cable	33
VCR and Cable Box.....	34
Two VCRs for Tape Editing	36
DVD Player with Component Video Connectors.....	37

DVD Player with S VIDEO and Audio Connectors.....	38
Personal Computer	39
Camcorder or "PlayStation".....	40
Audio Receiver.....	40

Watching the TV

Overview	41
Inserting Batteries into the Remote Control	41
Button Descriptions	42
Programming the Remote Control	44
Using Other Equipment with Your Remote Control	46
Special Buttons on the Remote Control	48
Using the GUIDE Button	48
Using the WIDE Button	50
Using the JUMP Button.....	51
Using the FREEZE Button.....	51
Using the POWER SAVING Button.....	51

Introducing WEGA GATE

Overview of WEGA GATE	52
Navigating and Selecting Items	54
Using Favorites in WEGA GATE	54
Using Cable in WEGA GATE	55
Using Antenna in WEGA GATE	55
Using External Inputs in WEGA GATE	56
Using Photo in WEGA GATE	56
Using Video in WEGA GATE	56
Using Settings in WEGA GATE	56

(Continued)

Using the Photo/Video Viewer

About USB	57
Features	57
Connecting Your Camera via the USB	
Interface	57
Connecting the USB Cable	58
File Compatibility	58
Using the Photo/Video Viewer Index	59
Using the Photo/Video Viewer Index	60
Viewing Photos	61
Photo Controls	61
Photo Menu Bar Options	62
Using Zoom and Pan	63
Using Rotate	63
Playing Movies	64
Movie Controls	64
Movie Menu Bar Options	65
Photo/Video Viewer Index Menu Bar	
Options	66
Slide Show Menu Options	66
Contents Menu Options	67
USB Media Menu	67
Notes on Using USB Media	68
About DCF File Names	68

Using the Settings

Overview	69
Accessing the Video Settings	71
Selecting Video Options	71
Selecting PC Video Options	73
Accessing the Audio Settings	74
Selecting Audio Options	74
Selecting PC Audio Options	76
Accessing the Screen Settings	77
Selecting Screen Options	77
Selecting PC Screen Options	79
Accessing the Channel Settings	80
Selecting Channel Options	80
Accessing the Parental Lock Settings	82
Selecting Parental Lock Options	82
Viewing Blocked Programs	83
Selecting Custom Rating Options	83
Accessing the Setup Settings	85
Selecting Setup Options	85
Programming Caption Vision	87
Selecting PC Setup Options	88

Accessing the Applications Settings	90
Selecting Applications Options	90

Other Information

Overview	92
Contacting Sony	92
Troubleshooting	92
Remote Control	92
CableCARD Device	93
Video	93
Audio	94
Channels	95
USB	95
General	97
Specifications	98
Index	99

Introducing the TV

Welcome

Thank you for purchasing this Sony LCD digital TV. This manual is for models KDL-V26XBR1, KDL-V32XBR1 and KDL-V40XBR1.

Package Contents

Along with your new TV, the packing box contains a remote control, and two AA (R6) batteries. See page 98 for the complete list of packaging contents.

Features

Some of the features that you will enjoy with your new TV include:

- WEGA GATE™:** WEGA GATE is a new feature that allows you to easily navigate to the most convenient TV functions: favorite channels, cable channels, antenna channels, external input list, viewing photo and movies or settings.
- WEGA Engine:** Delivers superb picture quality from any video source by minimizing the signal deterioration caused by digital-to-analog conversion and stabilizing the signal processing. This engine features unique Sony technology, including:
 - The first step in the digital processing system, Composite Component Processor (CCP-X), which enhances input signal-to-noise ratio by chroma decoder digital processing.
 - **DRC® (Digital Reality Creation)-MF V1:** Unlike conventional line doublers, the DRC Multifunction feature replaces the signal's NTSC waveform with the near-HD equivalent by digital mapping processing. The DRC Palette option lets you customize the level of detail (Reality) and smoothness (Clarity) to create up to three custom palettes.
- Integrated HDTV:** You can watch digital television programs and enjoy the improved audio/video quality offered by these programs.
- Wide Screen Mode:** Watch conventional 4:3 aspect ratio broadcasts in wide screen (16:9) mode.
- S-master Full Digital Amplifier:** Delivers superb clear dialog and reproduces the original sound quality while minimizing any sound fragmentation or jitter noise.
- CineMotion®:** Using the reverse 3-2 pull down technology, the CineMotion feature provides smoother picture movement when playing back movies or other video sources on film.
- Parental Control:** V-Chip technology allows parents to block unsuitable programming from younger viewers.

(Continued)

- **CableCARD™ slot:** Provides cable subscribers with access to digitally encrypted cable channels — without the need for a set-top box — that will enable you to receive not only standard definition but also high definition television. The CableCARD device, which is provided by your cable TV company, is inserted into the TV's rear panel CableCARD slot. After the service is activated with your cable TV company, the card replaces the need for a separate set-top box. (Check with your cable TV company about CableCARD service details, limitations, pricing, and availability. For more information about CableCARD device in this manual, see page 29.)
- **Component Video Input:** Offers the best video quality for DVD (480p and 480i), and digital set-top box (1080i, 720p, 480p and 480i) connections.
- **Favorite Channels:** With the WEGA GATE function, allows you to navigate a list of up to 16 favorite channels without leaving the current channel.
- **Steady Sound®:** Equalizes volume levels so there is consistent output between programs and commercials.
- **HDMI (High-Definition Multimedia Interface):** Provides an uncompressed, all-digital audio/video interface between this TV and any HDMI-equipped audio/video component, such as a set-top box, DVD player, and A/V receiver. HDMI supports enhanced, or high-definition video, plus two-channel digital audio.
- **Light Sensor:** Allows the picture brightness level to be optimized to ambient light. The effect from the Light Sensor depends on the setting of Picture Mode and Power Saving. The factory setting is Off.
- **Caption Vision/ Info Banner:** Allows Closed Caption and/or Channel Programming Information to be displayed.



Installing the TV

Preventing the TV from Toppling Over

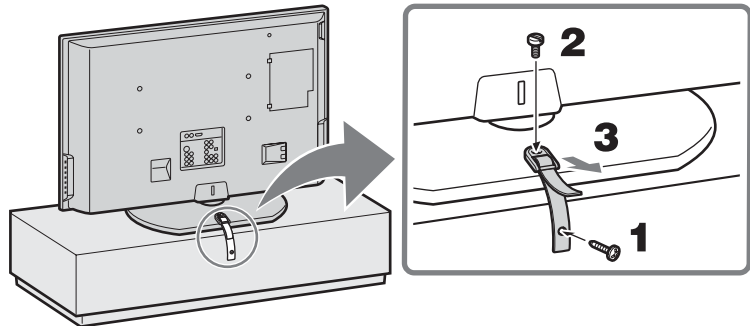
Attaching the Support Belt



- 1** Screw the support belt (supplied) to the TV stand with a wood screw (supplied).
- 2** Attach the support belt to the stand, and screw the belt with a securing screw (supplied) using a coin, etc.
- 3** Adjust the length by pulling the support belt towards you while holding the TV stand.

-  **Be sure to take measures to prevent the TV from toppling over and causing injury.**
-  **If the supplied wood screw does not fit depending on the type of TV stand, or when the securing strength is not enough, prepare commercial screws (3 to 4 mm (1/8 to 3/16 inches) diameter) to fit to the TV stand. Consult your dealer about the types of screw.**

When Mounting on a Wall

Be sure to use the following optional wall-mount brackets to hang the TV on the wall.

KDL-V26XBR1/KDL-V32XBR1: SU-WL31

KDL-V40XBR1: SU-PW2

See the Instruction Guide supplied with the wall-mount bracket on how to mount the TV on the wall.

Bundling the Connecting Cables

After the connections are done, organize the cables as illustrated below.

- 1 Attach the cable holder (supplied) to the rear of the TV (A), then turn the cable holder a quarter turn to the left (B).
- 2 Push the clasp lever in to release the lock and open the cover, and then insert the cables.
- 3 Close the cover until it clicks shut and locks.

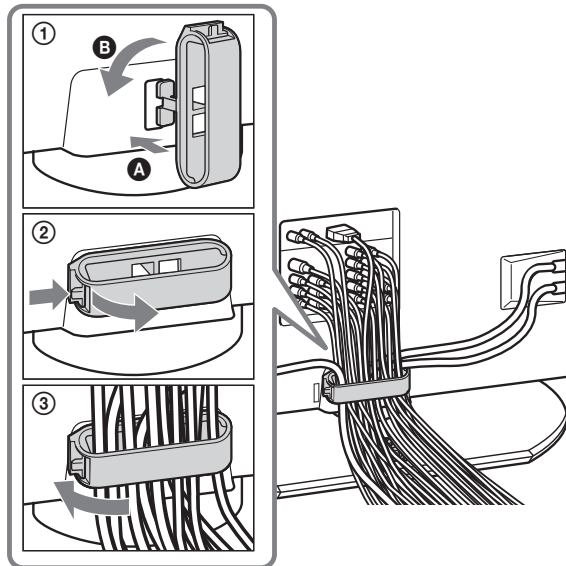



Adjusting the Viewing Angle of the TV

This TV can be adjusted within the angles shown below.

Adjust the angle back and forth (tilt) (KDL-V26/32XBR1 only)

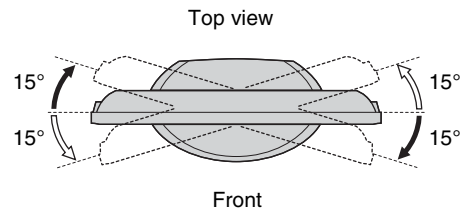
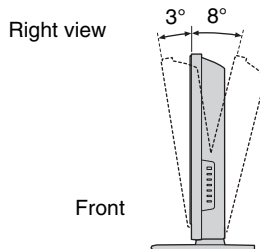
Adjust the angle left and right (swivel)



 **When adjusting the angle, hold the stand with one hand to avoid slipping or tipping the stand.**

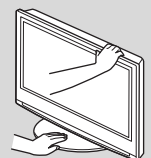

TV Controls and Connectors

Front Panel

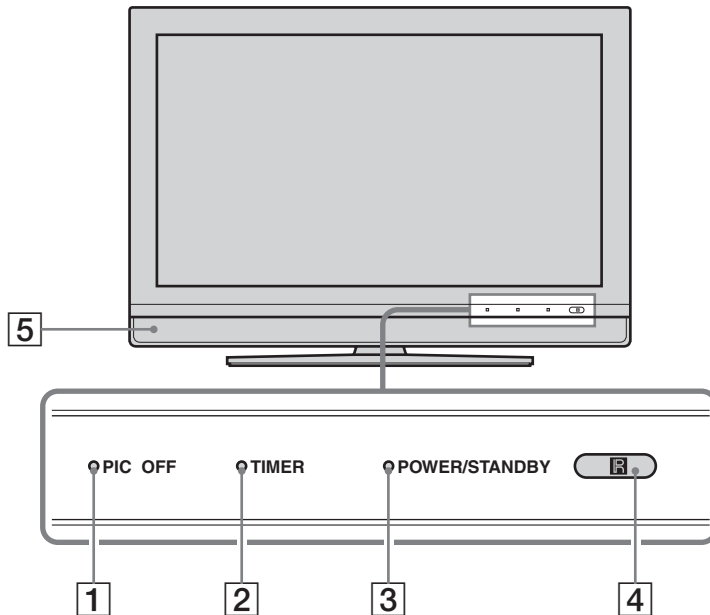

Item	Description
1	PIC OFF LED When lit, indicates that the Picture Off feature is activated. For details, see page 86.
2	TIMER LED When lit, indicates one of the timers or Sleep is set. When it is set, this LED will remain lit even if the TV is turned off. For details, see page 90.
3	POWER/STANDBY LED Lights up in green when the TV is turned on. The LED lights up red when in standby mode for both TV and PC input. The standby mode for PC input is set by setting Power Management to On in the PC Setup settings. If the LED blinks in red continuously, this may indicate the TV needs servicing (see “Contacting Sony” on page 2).
4	(IR) Infrared Receiver/Light Sensor Receives IR signals from the remote control. Senses room light level and adjusts the screen brightness accordingly (for details, see page 86). Do not put anything near the sensor, as its function may be affected.
5	Speaker Outputs audio signal.

Side Panel

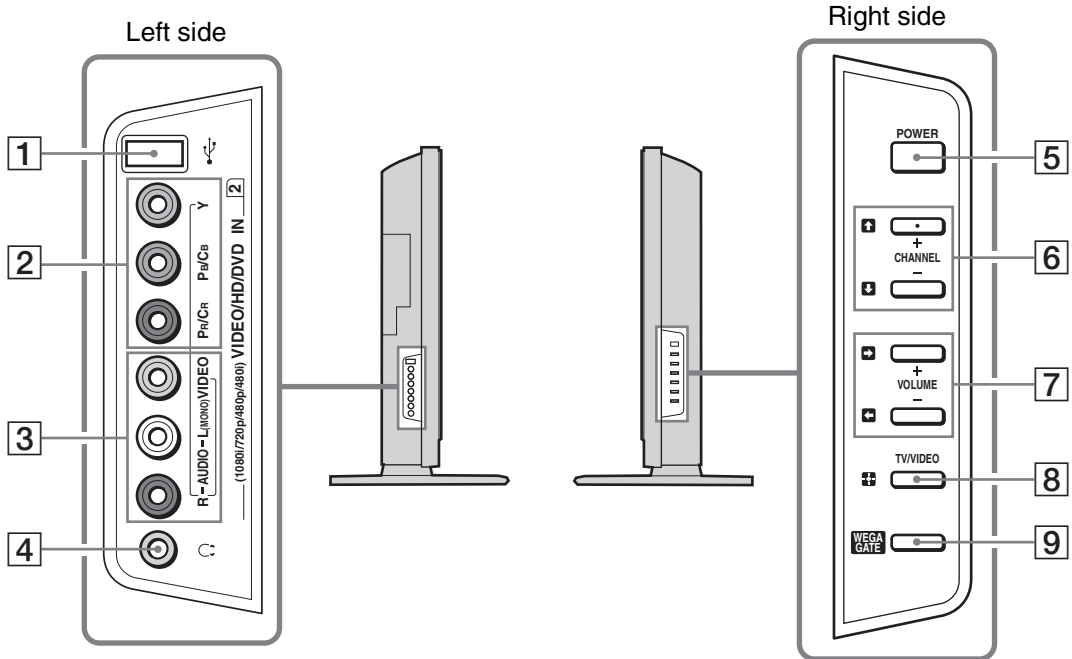

Item	Description
1	USB jack Connects to the USB port on your USB device. Provides a secure digital connection between your TV and USB device, such as digital video camcorders and digital cameras.
2	VIDEO/HD/DVD 2 IN Y PB/CB PR/CR Connect to your component video (YPbPr) and audio (L/R) output jacks of your DVD player or digital TV receiver. Component video provides better picture quality than the composite video (3) connection.
3	VIDEO/HD/DVD 2 IN VIDEO/(MONO) L-AUDIO-R Connect to the composite video and audio output jacks on your camcorder or other video equipment. When Auto is selected for the Video 2 (Component) option in the Setup settings, the component video function will be preferentially activated (see page 86).
4	Headphones jack Connects to your headphones. If your headphones do not match the jack, use a suitable plug adaptor (not supplied).
5	POWER Press to turn on and off the TV.
6	↑ + CHANNEL ↓ - Press to scan through channels. To scan quickly through channels, press and hold down either + or -. On the WEGA GATE screen, these buttons serve as up/down buttons.
7	➡ + VOLUME ← - Press to adjust the volume. On the WEGA GATE screen, these buttons serve as right/left buttons.
8	↔ /TV/VIDEO Press to confirm the selection or setting in WEGA GATE. Press repeatedly to cycle through the video equipment connected to the TV's video inputs.
9	WEGA GATE Press to display WEGA GATE. Press again to exit WEGA GATE.

The CHANNEL + button has a tactile dot. Use the tactile dot as a reference when operating the TV.

Rear Panel

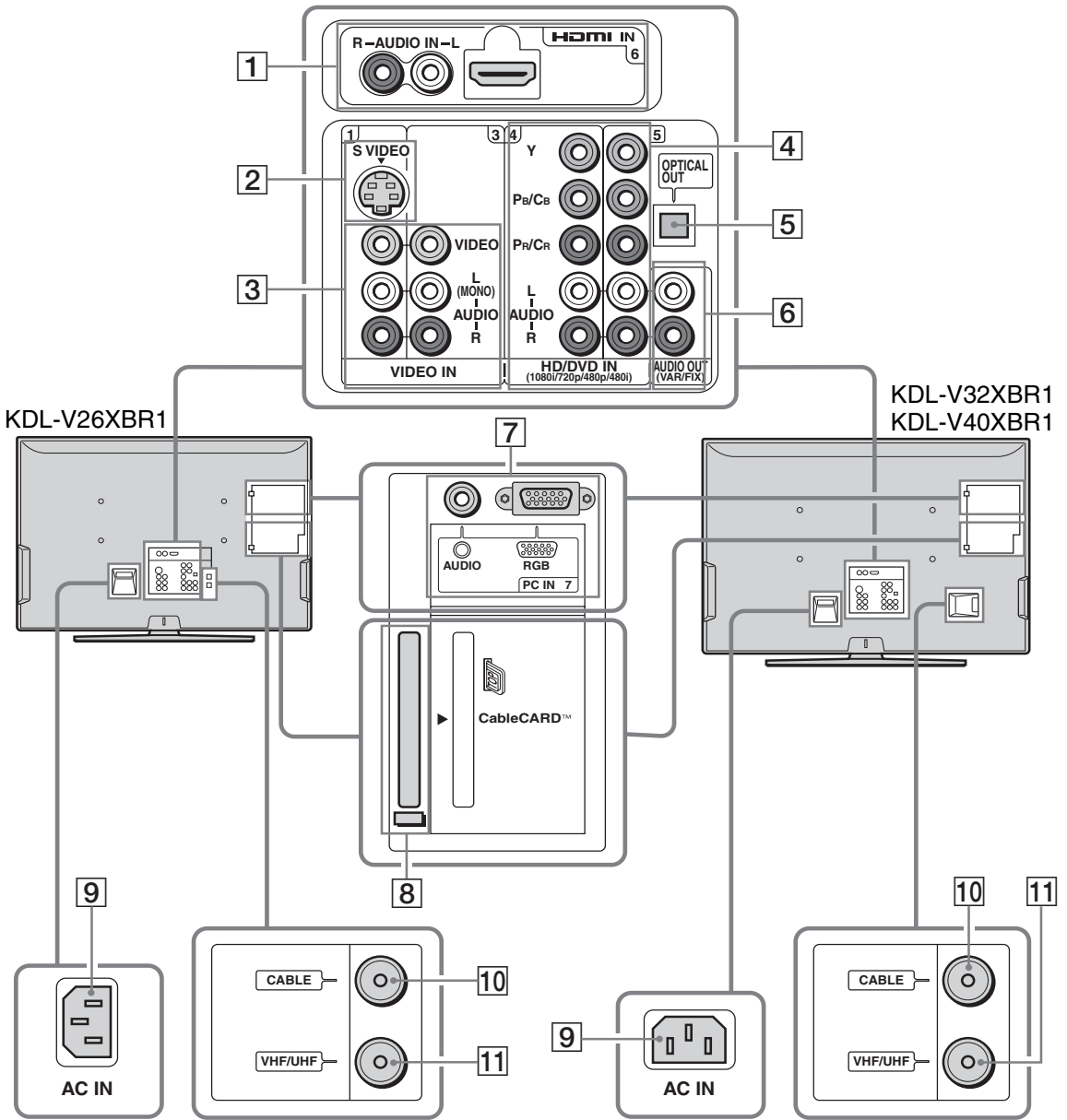

(Continued)

Introducing the TV

Jack	Description
1 HDMI 6 IN HDMI/ R-AUDIO IN-L	HDMI (High-Definition Multimedia Interface) provides an uncompressed, all-digital audio/video interface between this TV and any HDMI-equipped audio/video component, such as a set-top box, DVD player, and A/V receiver. HDMI supports enhanced, or high-definition video, plus two-channel digital audio. The AUDIO IN (L/R) of HDMI IN is for DVI connection. For details, see page 27.
2 VIDEO 1 IN S VIDEO	Connects to the S VIDEO output jack of your VCR or other video equipment that has S VIDEO. S VIDEO provides better picture quality than the composite video (3) connection.
3 VIDEO 1/3 IN VIDEO/ L (MONO)- AUDIO-R	Connect to the composite video and audio output jacks on your VCR or other video component. A third composite video and audio (VIDEO/HD/DVD 2 IN) is located on the left side panel of the TV.
4 HD/DVD 4/5 IN (1080i/720p/ 480p/480i)/ L-AUDIO-R	Connect to your DVD player's or digital set-top box's component video (YPbPr) and audio (L/R) jacks. Component video provides better picture quality than the S VIDEO (2) or the composite video (3) connections.
5 OPTICAL OUT (PCM/DOLBY* DIGITAL)	Connects to the optical audio input of a digital audio component that is PCM/Dolby Digital compatible.
6 AUDIO OUT (VAR/FIX)	Connect to the left and right audio input jacks of your audio or video equipment. You can use these outputs to listen to your TV's audio through your stereo system.
7 PC 7 IN (AUDIO/RGB)	Connects to personal computer's video and audio output connectors. Can be connected to other Analog RGB devices such as Video Conferencing or Set-top Boxes. See "PC Input Signal Reference Chart" on page 89 for the signal to be displayed.
8 CableCARD slot	CableCARD device provides cable subscribers with access to secure, digitally encrypted cable channels — without the need for a set-top box — that will enable you to receive not only standard definition but also high definition television. For details, see page 29.
9 AC IN	Connects the supplied AC power cord.
10 CABLE	RF input that connects to your cable signal.
11 VHF/UHF	RF input that connects to your VHF/UHF antenna.

* Manufactured under license from Dolby Laboratories. "Dolby" and the double-D symbol are trademarks of Dolby Laboratories.

Connecting the TV

Overview

Your new LCD TV can receive both analog and digital (HD and SD) broadcasting signals from antenna, satellite and cable TV company.





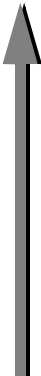

To display clear crisp pictures, you must connect your TV correctly and choose the correct display format (see “Using the WIDE Button” on page 50). It is strongly recommended to connect the cable and antenna inputs using a 75-ohm coaxial cable to receive optimum picture quality signal. A 300-ohm twin lead cable can be easily affected by radio noise and the like, resulting in signal deterioration. If you use a 300-ohm twin lead cable, keep it as far away as possible from the TV.

Making Video and Audio Connections

The signals that enter your TV and connected devices will need to output in the correct format using the suitable connections. Below are different types of video connectors available these days. Your TV comes with all types of connectors with the exception of the DVI connector but your cable box or satellite receiver may be equipped with this type. When connecting your TV, use the inputs that are available on your devices that provide the best video performance, as to below.

Best Video Performance



	Connector type	Separate audio connection required
	HDMI (High-Definition Multimedia Interface)	No
	DVI (Digital Visual Interface) *	
	Component video (480i/480p/720p/1080i)	Yes 
	S VIDEO	
	Composite video	
	RF/Coaxial	No

*An adapter is necessary when you are connecting a DVI-equipped device to this TV (see page 20).

About Using S VIDEO



If the optional equipment you are connecting has an S VIDEO jack (shown at left), you can use an S VIDEO cable for improved picture quality (compared to an A/V cable). Because S VIDEO carries only the video signal, you also need to connect audio cables for sound, as shown below.

Example of an S VIDEO Connection

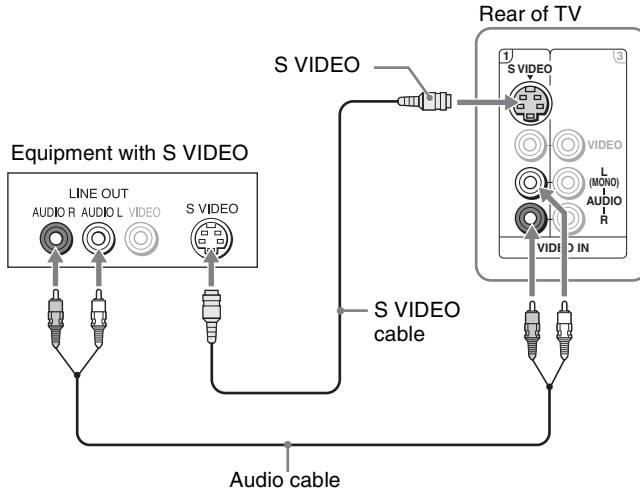

Cables are often color-coded to connectors. Connect red to red, white to white, etc.

About Using HDMI to DVI Adapter

If you are connecting equipment with DVI connector to this TV, you will need to use an adapter. You can use an HDMI-to-DVI cable or an HDMI adapter (not supplied). Both are available at your local electronics store. When you use the adapter, you will also need to use separate audio cables for sound as DVI connector is for video signals only.



HDMI-to-DVI Cable



HDMI adapter



Audio cable

Basic Connections

The way in which you connect your TV will vary, depending on how your home receives a signal (antenna and satellite; cable and cable box) and whether or not you plan to connect a VCR.

If You Are Connecting...	See Page
Cable System or VHF/UHF	21
<input type="checkbox"/> No cable box or VCR	
Cable Box and Antenna	22
<input type="checkbox"/> Cable box unscrambles only some channels (usually premium channels)	
<input type="checkbox"/> No VCR	
Cable Box	23
<input type="checkbox"/> Cable box unscrambles all channels	
<input type="checkbox"/> No VCR	
Satellite Receiver	24
Digital Cable Box or Digital Satellite Receiver	25
Equipment with HDMI Connection	26
Equipment with DVI Connection	27
Equipment with Digital Audio (OPTICAL)	28

If you are connecting a VCR

- See the connection described on pages 33 and 34.

Cable System or VHF/UHF

For best results, use this connection if:

- You have a cable and/or an antenna.
(This is convenient if you are using a separate rooftop antenna to receive additional channels that are not provided by your cable TV company.)
- You do not have a cable box or VCR. (If you have a cable box, see pages 22 and 23. If you have a VCR, see pages 33 and 34.)

Antenna System

Cable Type Connect As Shown

Cable TV (CATV)
and Antenna

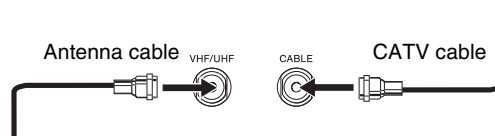

Notes on Using This Connection

To Do This...	Do This ...
Switch the TV's input between the cable and antenna	Press ANT to switch back and forth between the TV's VHF/UHF and CABLE inputs.

Do not use an indoor antenna, which is especially susceptible to radio noise.

Cable Box and Antenna

Before connecting a cable box, see "Using CableCARD Device" on page 29.

For best results, use this connection if:

- Your cable company scrambles some channels, such as premium channels (which requires you to use a cable box), but does not scramble all channels.
- You do not have a VCR. (If you have a VCR, see pages 33 and 34.)

With this connection you can:

- Use the TV's remote control to change channels coming through the cable box to the TV's CABLE input jack. (You must first program the remote control for your specific cable box; see "Programming the Remote Control" on page 44.)
- Use the TV's remote control to change channels coming directly into the TV's VHF/UHF input jack.

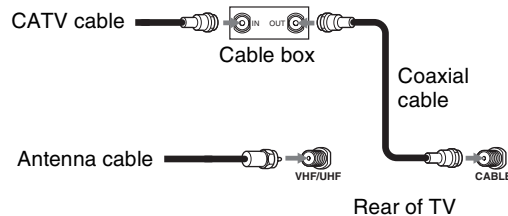

Notes on Using This Connection

To Do This ...	Do This ...
Use the cable box	Tune the TV to the channel the cable box is set to (usually channel 3 or 4) and then use the cable box to switch channels.
Set up the TV remote control to operate the cable box	Program the remote control. See "Programming the Remote Control" on page 44.
Activate the remote control to operate the cable box	Press SAT/CABLE (FUNCTION) .
Prevent the accidental switching of TV channels	When using the cable box, ensure that the TV remains tuned to the channel that the cable box is set to (usually channel 3 or 4).
Switch the TV's input between the cable box and antenna	Press ANT to switch back and forth between the TV's VHF/UHF (scrambled channels) and CABLE (unscrambled) inputs.

Cable Box

Before connecting a cable box, see "Using CableCARD Device" on page 29.

For best results, use this connection if:

- Your cable company scrambles all channels, which requires you to use a cable box.
- You do not have a VCR. (If you have a VCR, see pages 33 and 34.)

With this connection you can:

- Use the TV's remote control to change channels coming through the cable box to the TV's VHF/UHF input jack. (You must first program the remote control for your specific cable box.)

To connect the cable box

- 1** Connect the CATV cable to the cable box's input jack.
- 2** Use a coaxial cable to connect the cable box's output jack to the TV's VHF/UHF input jack.
- 3** Run Auto Program, as described in "Setting Up the Channel List" on page 31.

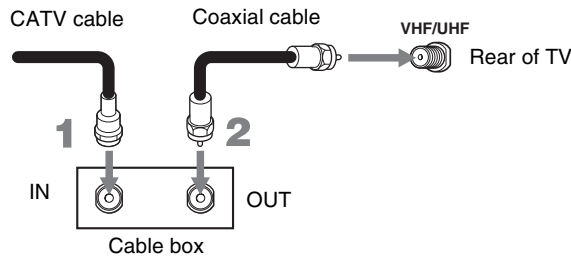

Notes on Using This Connection

To do this...	Do This ...
Use the cable box	Tune the TV to the channel the cable box is set to (usually channel 3 or 4) and then use the cable box to switch channels.
Set up the TV remote control to operate the cable box	Program the remote control. See "Programming the Remote Control" on page 44.
Activate the remote control to operate the cable box	Press SAT/CABLE (FUNCTION).
Prevent the accidental switching of TV channels	When using the cable box, ensure that the TV remains tuned to the channel that the cable box is set to (usually channel 3 or 4).

Satellite Receiver

Disconnect all power sources before making any connections.

- 1 Connect the satellite antenna cable to the satellite receiver's SATELLITE IN jack.
- 2 Use A/V and S VIDEO cables to connect the satellite receiver's AUDIO and S VIDEO OUT jacks to the TV's AUDIO and S VIDEO IN jacks.
- 3 Use a coaxial cable to connect your cable to the TV's CABLE jack, or your antenna to the TV's VHF/UHF jack.

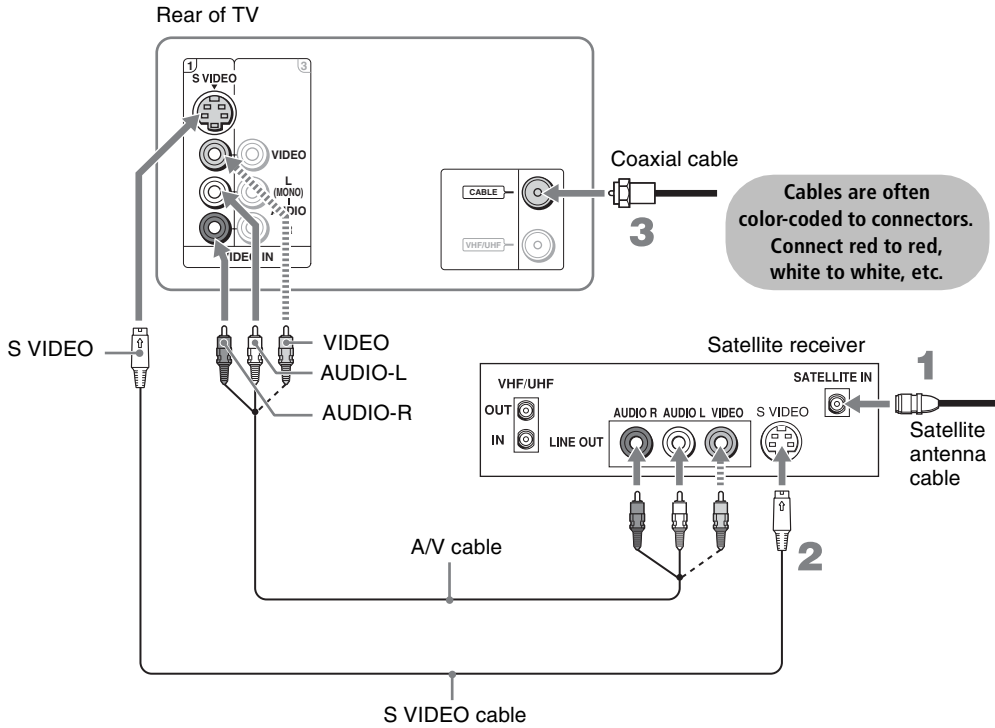

 If your satellite receiver is not equipped with S VIDEO, use a VIDEO cable (yellow) instead of the S VIDEO cable.

Digital Cable Box or Digital Satellite Receiver

Disconnect all power sources before making any connections.

- 1 Connect the RF coaxial cable from the CATV or satellite dish to the input of the digital cable box or digital satellite receiver.
- 2 Use a component video cable to connect the YPBPR jacks of your digital cable box or digital satellite receiver to the TV's component jacks.

 **Component video (Y PB/CB PR/CR) connection is necessary to view digital broadcastings in 1080i, 720p, 480i and 480p. This TV displays all format types of picture in a resolution of 1,366 dots × 768 lines.**

- 3 Use an audio cable to connect the AUDIO OUT jack of the digital cable box or digital satellite receiver to the TV's AUDIO IN jacks.

 **The component Jacks (Y PB/CB PR/CR) do not provide audio, so audio cables must be connected to provide sound.**

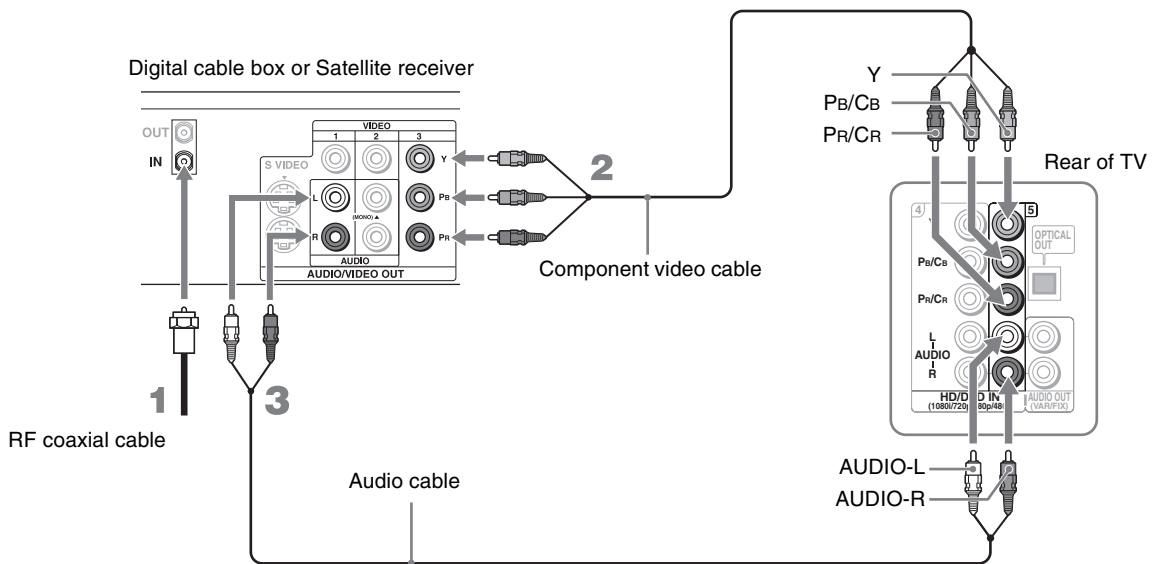

Cables are often color-coded to connectors. Connect red to red, white to white, etc.

Equipment with HDMI Connection

For best results, use this connection if:

- Your equipment has a High-Definition Multimedia Interface (HDMI).

Disconnect all power sources before making any connections

Use an HDMI cable, connect the equipment's HDMI OUT jack to the TV's HDMI IN jack.

💡 The HDMI jack provides both video and audio signals, so it is not necessary to connect the audio cable.

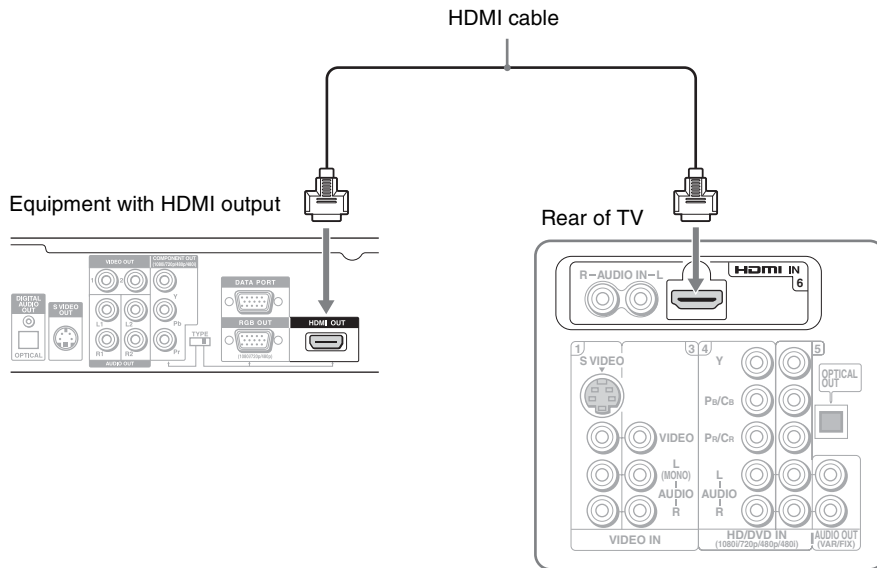

Equipment with DVI Connection

Disconnect all power sources before making any connections

If you are connecting with DVI-HDTV output, you can connect to the TV's HDMI IN jack by using an HDMI-to-DVI cable or an adaptor.

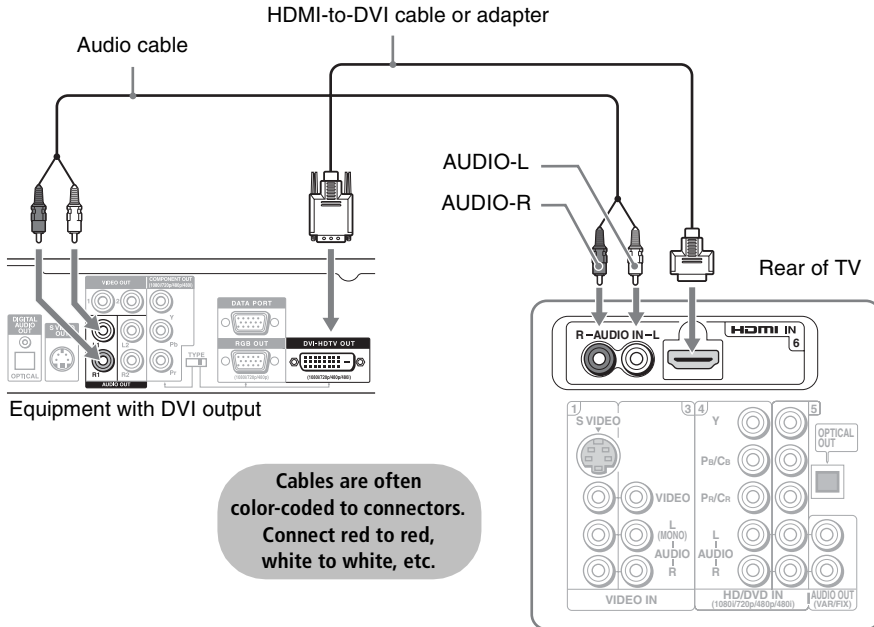

Cables are often color-coded to connectors. Connect red to red, white to white, etc.

 **When using an HDMI-to-DVI cable or an adaptor, be sure to connect the DVI output connector first; then connect to the HDMI input on your TV.**

**Equipment with
Digital Audio
(OPTICAL)**

Disconnect all power sources before making any connections.

You can use the TV's OPTICAL OUT jack to connect a digital audio device that is PCM/Dolby digital compatible, such as an audio amplifier.

Use an optical audio cable to connect the TV's OPTICAL OUT jack to the device's OPTICAL IN jack.

Rear of TV

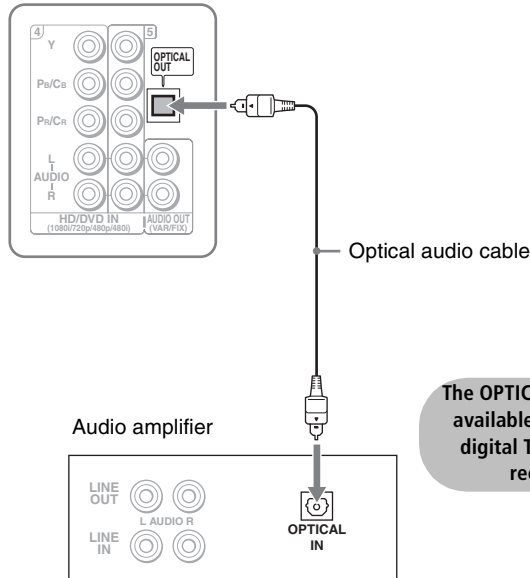

The OPTICAL OUT jack is available only when a digital TV channel is received.

Using CableCARD Device

CableCARD device provides cable subscribers with access to digitally encrypted cable channels — without the need for a set-top box — that will enable you to receive not only standard definition but also high definition television. The CableCARD device, which is provided by your cable TV company, is inserted into the TV's rear panel CableCARD slot. After the service is activated with your cable TV company, the card replaces the need for a separate set-top box.

About Using CableCARD Device

If you are planning to use a separate cable box for digital cable TV services, you may be able to receive programming using this TV with the CableCARD device instead — except in the following circumstances:

- Your cable TV company does not provide CableCARD service in your viewing area.
- You want to access your cable TV company's interactive or advanced features (such as video-on-demand or, in some cases, pay-per-view). At this time, these services require a bidirectional link, which are only available through the use of a separate set-top box. The CableCARD device is currently a unidirectional device only, and cannot provide these advanced services.

Check with your cable TV company for CableCARD service details, limitations, pricing, and availability, all of which are determined by your cable TV company — not Sony.

Activating CableCARD Service

Before you can use CableCARD service, you need to insert the CableCARD device (supplied by your cable TV company) and activate the service, as described below:

- 1** Remove the cover and insert the CableCARD device into the TV's CableCARD slot.

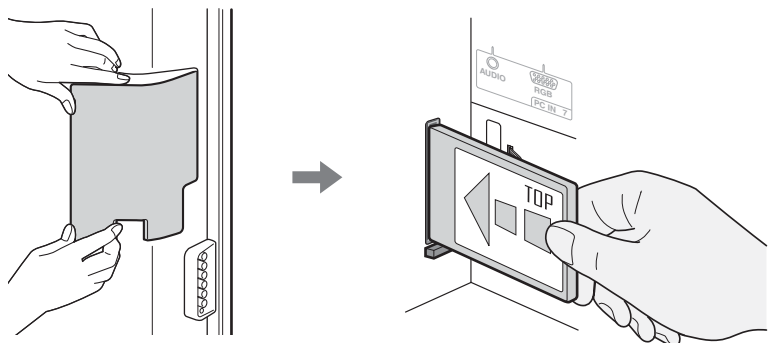

(Continued)

 You can also access information about your CableCARD device in the Applications settings (see page 91).

 **CAUTION: Inserting the CableCARD device incorrectly may result in permanent damage to the card and the TV.**

- 2 Gently push the card into the slot until it locks into place, and then reattach the cover.
- 3 After 1-2 minutes, the CableCARD device setup screen is automatically displayed. This screen includes information your cable TV company will request before they can activate your service.
- 4 Follow the displayed instructions: Phone your cable TV company. A representative will guide you through the activation process.
- 5 After your CableCARD device is activated, your cable TV company will download the service information, including the channel list, to the CableCARD device. After the CableCARD device has acquired channels from your cable TV company, the TV tunes to the lowest available channel.

Removing the CableCARD Device

In the event you want to cancel your service, contact your cable TV company.

 **Once the CableCARD device is removed, your TV will no longer decrypt digital cable TV programming services that require CableCARD device.**

- 1 Push the eject button on the TV's CableCARD slot to release the card.

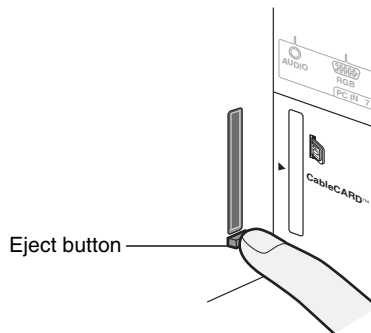

- 2 Pull the CableCARD device straight out of the slot to remove it. To install a different CableCARD device, follow the instructions in “Activating CableCARD Service” on page 29.







Setting Up the Channel List

After you finish connecting the TV, you can run the Initial Setup to create a list of available analog and digital channels. The Initial Setup screen appears when you turn on the TV for the first time after hooking it up. If you choose to set up the channels at a later time, select the Auto Program option in the Channel setting to scan available channels (see below).

 **The Initial Setup feature does not apply for installations that use a cable box for all channel selection.**

Using Initial Setup

To run Initial Setup the first time you turn on your TV

- 1 Press  to turn on the TV.
The Initial Setup screen appears.
- 2 Press  or  to highlight the on-screen display language. Then press . The message “First please connect cable and/or antenna.” appears. This may require 50+ minutes for completion and “Start auto program now?” appears.
- 3 Press  or  to highlight “Yes” then press .



Auto Program performed through Initial Setup will automatically create a list of receivable channels from both VHF/UHF antenna and cable TV channels if both sources are connected.

 **Auto Program may take a while (20 to 50 minutes) to complete. A progress bar is displayed while available channels are being scanned. If you cancel the Auto Program before all receivable channels are scanned, you may want to perform the task later (see “To run Auto Program at a later time” below).**

 **If you selected “No” during the Initial Setup, the Initial Setup message will appear each time you turn on the TV until you complete the Auto Program as a reminder.**

To run Auto Program at a later time

- 1 Select Settings in WEGA GATE, and then go to Channel settings.
- 2 Select Auto Program then select Start.

 **Auto Program will create a list of receivable channels for the current input (VHF/UHF antenna or CABLE). You will be required to run Auto Program for each RF input to create a list of available channels from both inputs.**

Connecting Optional Equipment

You can connect a variety of optional equipment to your TV. This section provides some of the individual connections you can make. For multiple connections, please refer to the Quick Setup Guide.

<i>If You Are Connecting...</i>	<i>See Page</i>
<i>VCR and Cable</i>	33
<i>VCR and Cable Box</i>	34
<i>Two VCRs for Tape Editing</i>	36
<i>DVD Player with Component Video Connectors</i>	37
<i>DVD Player with S VIDEO and Audio Connectors</i>	38
<i>Personal Computer</i>	39
<i>Camcorder or "PlayStation"</i>	40
<i>Audio Receiver</i>	40

VCR and Cable

For best results, use this connection if:

- You have cable TV that does not require a cable box.

Disconnect all power sources before making any connections.

- 1** Connect the CATV cable to the single (input) jack of the splitter.
- 2** Use a coaxial cable to connect one of the output jacks of the splitter to the TV's CABLE input jack.
- 3** Use a coaxial cable to connect the splitter's other output jack to the VCR's input jack.
- 4** Use A/V and S VIDEO cables to connect the VCR's AUDIO and S VIDEO OUT jacks to the TV's AUDIO and S VIDEO IN jacks.

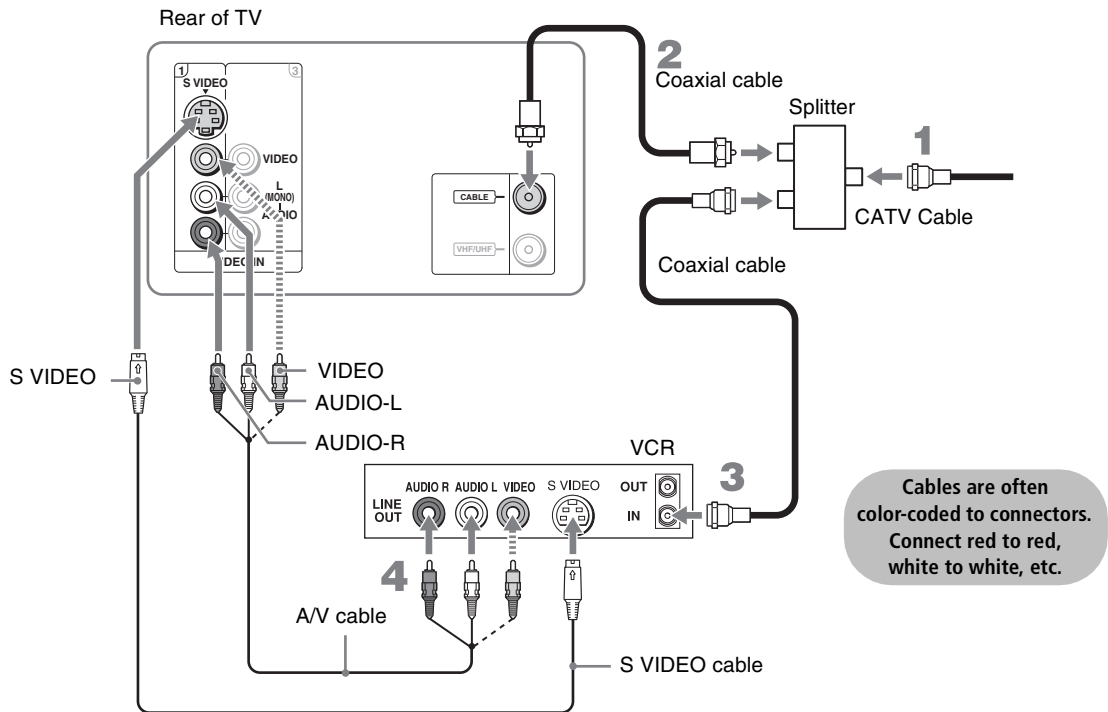

 If your VCR is not equipped with S VIDEO, use a VIDEO cable (yellow) instead of the S VIDEO cable.

VCR and Cable Box

Before connecting a cable box, see "Using CableCARD Device" on page 29.

For best results, use this connection if:

- Your cable TV company scrambles some channels, but not all of them (pay channels vs. regular cable channels) and you need to use a cable box.

With this connection you can:

- Use the TV's remote control to change channels on your cable box when the signal is scrambled. To program your Sony remote control to operate your cable box, see "Programming the Remote Control" on page 44.
- Use the TV's remote control to change channels on your TV when the signal is not scrambled. Your TV's tuner provides a better signal than the cable box.

Disconnect all power sources before making any connections.

- 1** Connect the CATV cable to the single (input) jack of the splitter.
- 2** Use a coaxial cable to connect one of the output jacks of the splitter to the TV's CABLE input jack.
- 3** Use a coaxial cable to connect the splitter's other output jack to the cable box's input jack.
- 4** Use a coaxial cable to connect the cable box's output jack to the VCR's RF input jack.
- 5** Use an A/V cable to connect the cable box's A/V output jacks to the TV's A/V input jacks.
- 6** Use A/V and S VIDEO cables to connect the VCR's AUDIO and S VIDEO OUT jacks to the TV's AUDIO and S VIDEO IN jacks.



If your VCR is not equipped with S VIDEO, use a VIDEO cable (yellow) instead of the S VIDEO cable.

- 7** Run Initial Setup, as described in "Setting Up the Channel List" on page 31.

If you are connecting a digital cable box, you will need a special bi-directional splitter designed to work with your cable box.

Cables are often color-coded to connectors. Connect red to red, white to white, etc.

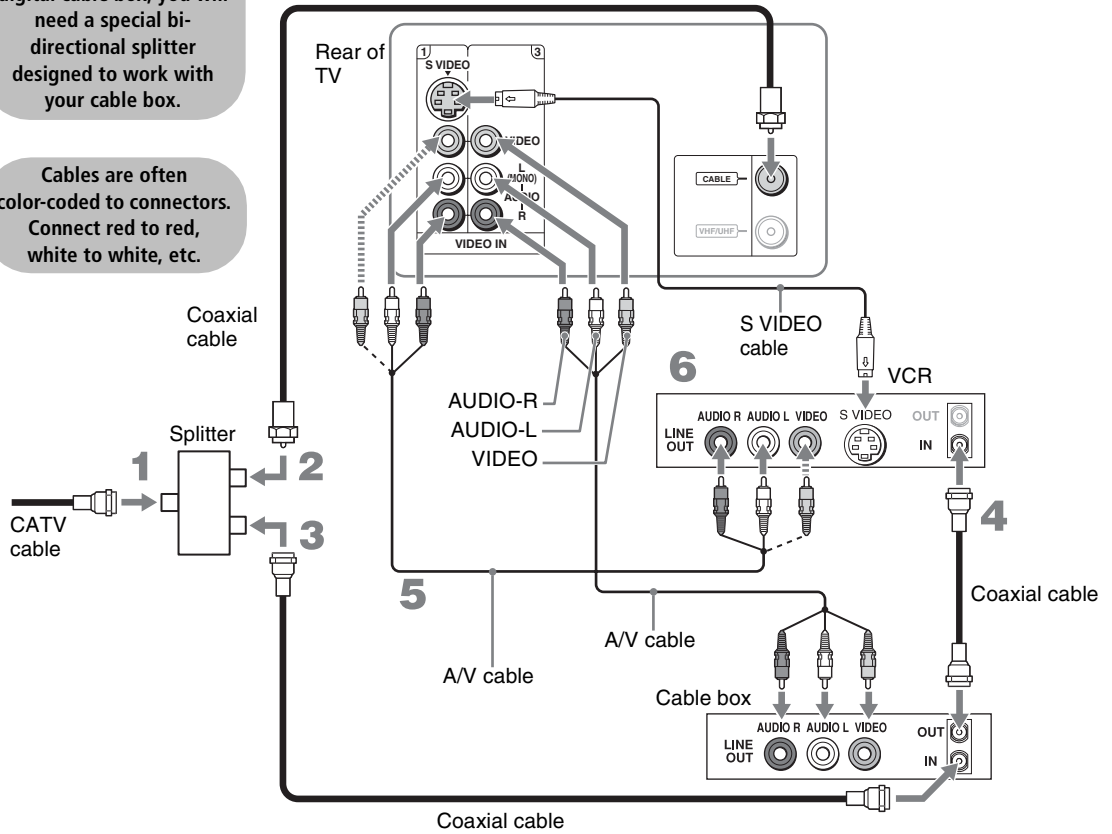

Two VCRs for Tape Editing



Using
S VIDEO jacks?
See page 20.

If you connect two VCRs, you can record from one VCR to the other while using your TV to monitor what is being recorded.

Disconnect all power sources before making any connections.

- 1 Use A/V cables to connect the playback VCR's A/V output jacks to the recording VCR's A/V input jacks.
- 2 Use A/V cables to connect the recording VCR's A/V output jacks to the TV's A/V input jacks.

Cables are often color-coded to connectors. Connect red to red, white to white, etc.

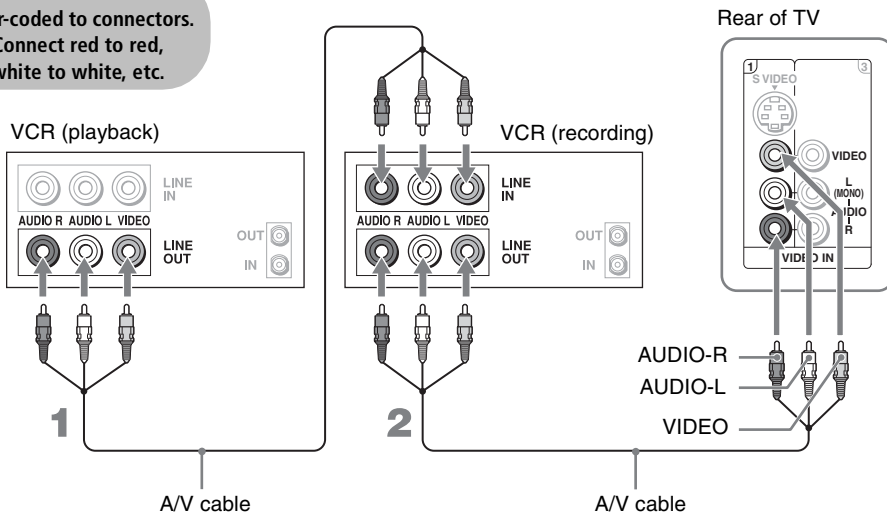

- To perform tape editing, set the TV to the video input intended for playback by pressing TV/VIDEO on the remote control.
- You may need to change the video input on your VCR. Consult your VCR's operating manual for instructions.
- If your VCRs have S VIDEO jacks: For best picture quality, use an S VIDEO connection instead of the video cable (yellow) on your combined A/V cable. Use an S VIDEO cable to connect the playback VCR's S VIDEO OUT jack to the recording VCR's S VIDEO IN jack. S VIDEO does not provide audio, so audio cables must be connected to provide sound.
- You cannot record signals from equipment connected to the Y PB/CB PR/CR input.

DVD Player with Component Video Connectors

For best results, use this connection if:

- Your DVD player has component (YPbPr) jacks.

Disconnect all power sources before making any connections.

- 1** Use a component video cable to connect the DVD player's YPbPr jacks to the TV's Y Pb/Cb Pr/CR jacks. Use the HD/DVD 4/5 IN or VIDEO/HD/DVD 2 IN Y Pb/Cb Pr/CR input.



The YPbPr jacks on your DVD player are sometimes labeled YCbCr, or Y, B-Y and R-Y. If so, connect the cables to like colors.

- 2** Use an audio cable to connect the DVD player's AUDIO OUT jacks to the TV's AUDIO IN jacks. Be sure to use the same row of inputs that you used for the video connection (HD/DVD 4/5 IN or VIDEO/HD/DVD 2 IN Y Pb/Cb Pr/CR).

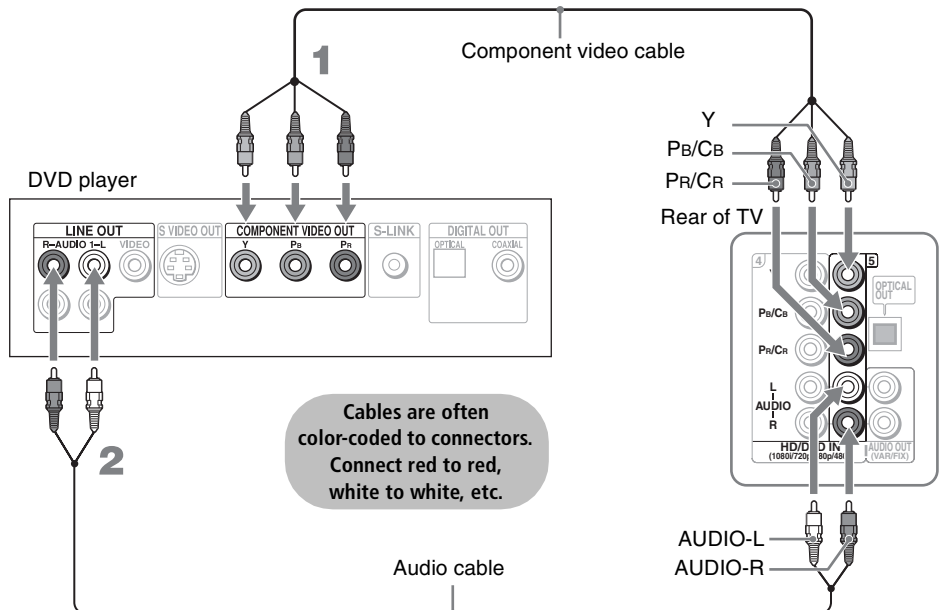

To take advantage of the Wide Mode feature on your TV, set the DVD player's aspect ratio to 16:9. For details, refer to the operating instructions supplied with your DVD player.

DVD Player with S VIDEO and Audio Connectors

For best results, use this connection if:

- Your DVD player does not have component (YPbPr) jacks.

Disconnect all power sources before making any connections.

- 1 Use an A/V cable to connect the DVD player's AUDIO OUT jacks to the TV's AUDIO IN jacks.
- 2 Use an S VIDEO cable to connect the DVD player's S VIDEO OUT jack to the TV's S VIDEO IN jack.

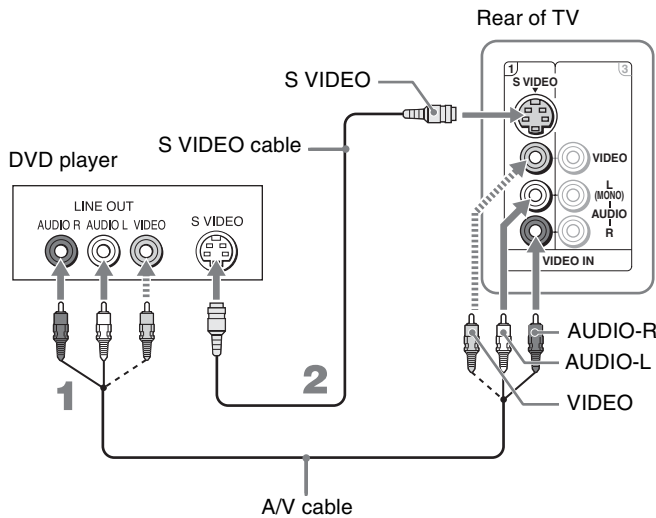

- If your DVD player is not equipped with S VIDEO, use a VIDEO cable (yellow) instead of the S VIDEO cable.
- To watch the DVD, press TV/VIDEO repeatedly to select the DVD input (VIDEO 1 in the illustration). If you have a non-Sony DVD player, and want to set up the TV remote control to operate the DVD player you must program the remote control. See "Programming the Remote Control" on page 44.
- To control DVD functions with the TV remote control, see "Operating a DVD Player or DVD Changer" on page 46.
- To easily identify equipment connected to the TV, see the instructions for setting up Label Video Inputs on page 85.

Personal Computer

💡 When connecting to an Apple Macintosh computer, use the supplied HD15-HD15 cable to connect PC IN of the TV to video output connector of the computer. For some Apple Macintosh computers, it may be necessary to use an adapter (not supplied). If this is the case, connect the adapter to the computer before connecting the HD15-HD15 cable.

💡 If the picture is noisy, flickering or not clear, adjust the Phase and Pitch in the PC Screen settings on page 79.

To connect a PC (personal computer)

If you connect your PC to the TV, you can watch your personal computer's display on the TV.

When your PC is connected to the TV with the HD15-HD15 cable and optional audio cable, you can view and listen to the PC's video and audio output on the TV.

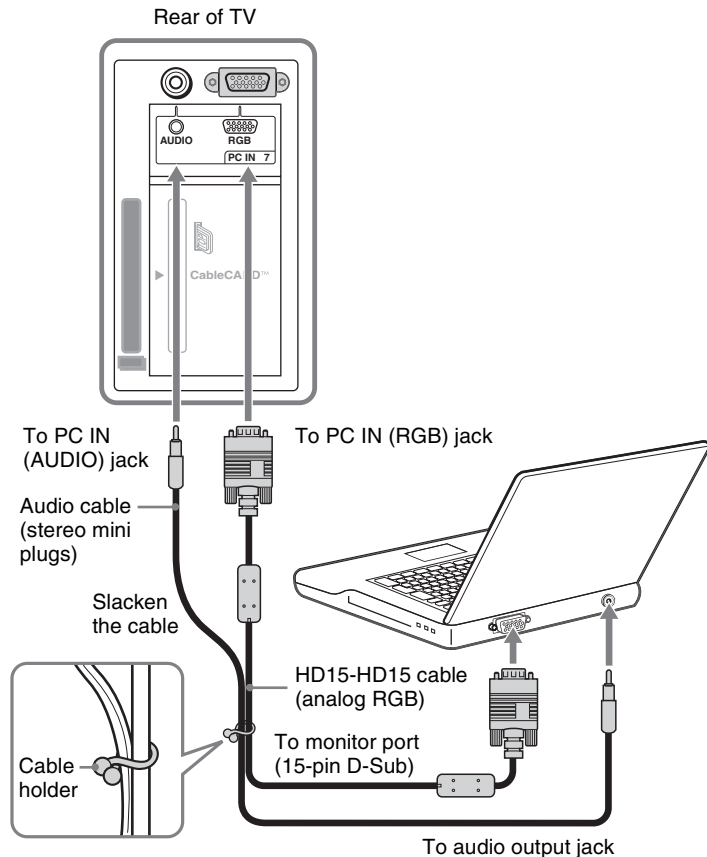

🔧 **If the audio cable is unstable, use the supplied cable holder to secure the cable as illustrated.**

Camcorder or "PlayStation"

Disconnect all power sources before making any connections.

For easy connection to a camcorder or "PlayStation," the TV has left side audio and video inputs (shown below). Select **Off** in the **Video 2 (Component)** option in the **Setup** settings (see page 86). Use an A/V cable to connect the camcorder or "PlayStation" A/V output jacks to the TV's A/V input jacks.

 **If you have a mono camcorder, connect its audio output jack to the TV's L (MONO) audio input jack.**

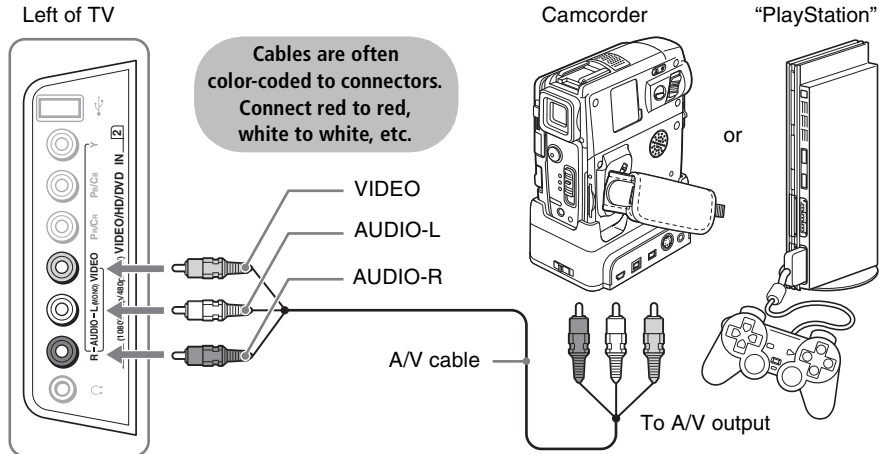

Audio Receiver

For improved sound quality, you may want to play the TV's audio through your stereo system (see page 75).

Disconnect all power sources before making any connections.

Use an audio cable to connect the TV's AUDIO OUT (VAR/FIX) jacks to the audio receiver's audio LINE IN jacks.

 **AUDIO OUT jacks are operable only when the TV's Speaker is set to Off.**

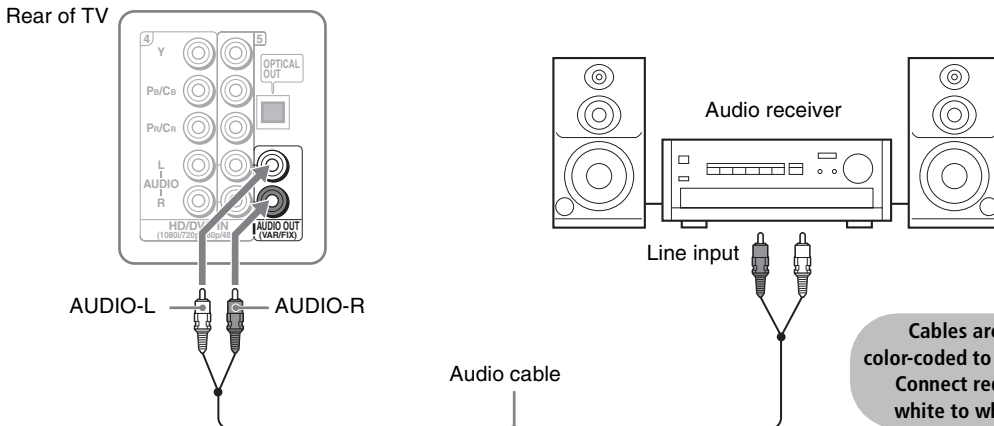

Watching the TV

Overview



The table on the next page describes the buttons on the remote control.

Topic	See Page
<i>Inserting Batteries into the Remote Control</i>	41
<i>Button Descriptions</i>	42
<i>Programming the Remote Control</i>	44
<i>Manufacturer's Codes</i>	45
<i>Using Other Equipment with Your Remote Control</i>	46
<i>Special Buttons on the Remote Control</i>	48

Inserting Batteries into the Remote Control

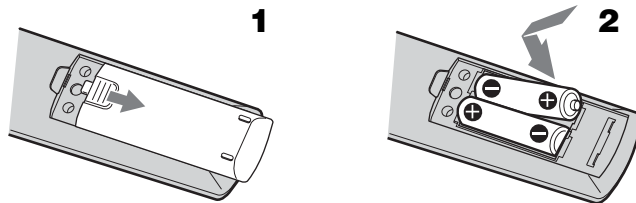
Insert two size AA (R6) batteries (supplied) by matching the **+** and **-** on the batteries to the diagram inside the battery compartment.



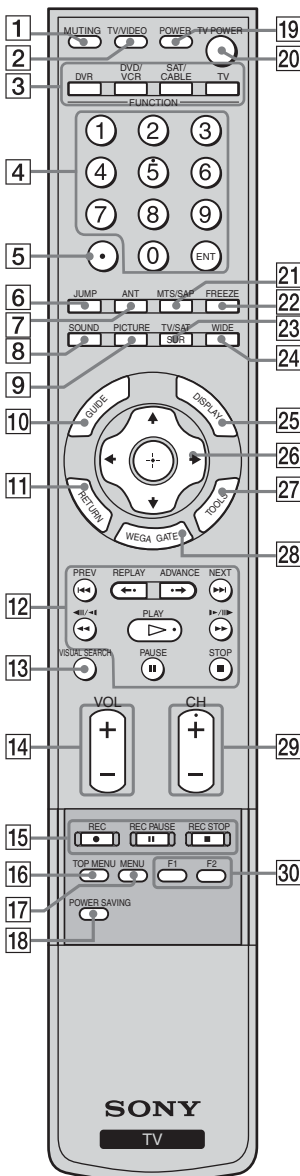

-  To avoid possible damage from battery leakage, remove the batteries if you anticipate the remote control will not be used for an extended period.
-  Handle the remote control with care. Avoid dropping it, getting it wet, or placing it in direct sunlight, near a heater, or in high humidity.
-  Your remote control can be programmed to operate most video equipment. (See “Programming the Remote Control” on page 44.)

Button Descriptions

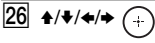
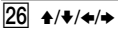

Button	Description
1 MUTE	Press to mute the sound. Press again or press VOL + to unmute.
2 TV/VIDEO	Press to cycle through the video equipment connected to your TV's video inputs.
3 FUNCTION Buttons	The FUNCTION button indicator lights up momentarily when pressed to show which external equipment the remote control is operating. When the remote control is set to operate the external equipment, these buttons will operate the equipment you choose. You must first press one of these FUNCTION buttons to operate the corresponding equipment. For details, see "Programming the Remote Control" on page 44.
4 0-9, ENT	Press 0-9 to select a channel: the channel changes after 2 seconds. Press ENT to change channels immediately.
5	Use with 0-9 and ENT buttons to select digital channels (for example, 2.1).
6 JUMP	Press to jump back and forth between two channels. The TV alternates between the current channel and the last channel that was selected.
7 ANT	Press to change between the VHF/UHF input and the CABLE input.
8 SOUND	Press to cycle through different sound settings: Dynamic for enhance treble and bass, Standard for spoken dialog and Custom for flat setting.
9 PICTURE	Press repeatedly to cycle through the available video picture modes: Vivid , Standard , Custom . The video picture modes can be also accessed in the Video settings. For details, see "Selecting Video Options" on page 71.
10 GUIDE	Press to display the TV's program guide.
11 RETURN	Press to return to normal viewing.
12 DVD/VCR Operating Buttons	When FUNCTION is switched on DVR or DVD/VCR, these buttons operate the video equipment you have programmed into the remote control. For details, see "Using Other Equipment with Your Remote Control" on page 46. PREV : Press to replay the current program from the previous Chapter Mark (if any) or from the beginning of the live TV cache. REPLAY : Press to replay the current program for a set period of time. ADVANCE : Press to advance forward a set period of time when playing back a recorded program. NEXT : Press to advance forward to the next Chapter Mark (if any) or to live TV when playing back a recorded program. (fast reverse) : Press to play a program in fast rewind mode. PLAY : Press to play a program at a normal speed. (fast forward) : Press to play a program in fast forward mode. PAUSE : Press to pause playback. STOP : Press to stop the playback of a recorded program.
13 VISUAL SEARCH	To be used only with your connected external equipment with visual search function. (Non-operable button for TV)
14 VOL +/-	Press to adjust the volume.

The 5 button, CH + button, MTS/SAP button and PLAY button have a tactile dot. Use the tactile dot as a reference when operating the TV.

Button	Description
15 DVD/VCR Record Buttons	<ul style="list-style-type: none"> ● REC: Press to record. By pressing this button alone will start the recording. ■ REC PAUSE: Press to pause the recording. ■ REC STOP: Press to stop the recording.
16 TOP MENU	Press to display the disc menu from your connected DVD player.
17 MENU	Press to display the disc menu from your connected DVD player.
18 POWER SAVING	Press to reduce the power consumption.
19 POWER (GREEN)	Press to turn on/off the external equipment selected from the FUNCTION buttons [3].
20 TV POWER	Press to turn on/off the TV.
21 MTS/SAP	Press repeatedly to cycle through the Multi-channel TV Sound (MTS) options: Stereo, Auto SAP (Second Audio Program), and Mono. The MTS setting can be also accessed in the Audio setting. For details, see “Selecting Audio Options” on page 74.
22 FREEZE	Press to freeze the current picture in a separate window. Press again to restore the picture. For details, see “Using the FREEZE Button” on page 51.
23 TV/SAT/SUR	<p>TV/SAT: While in SAT/CABLE (FUNCTION), press to switch between the satellite receiver and antenna.</p> <p>SUR: Press SUR (Surround Sound) repeatedly to step through the available audio effect models: TruSurround XT, Simulated, Off.</p>
24 WIDE	Press repeatedly to step through the Wide screen mode setting: Wide Zoom, Normal, Full and Zoom. The Wide screen mode setting can be also accessed in the Screen setting. For details, see “Using the WIDE Button” on page 50.
25 DISPLAY	Press once to display channel number, label, current time and other information. Press again to turn Display off. See page 90 for details on setting the time.
26 	Press  to move the on-screen cursor. To select an item, press  .
27 TOOLS	To be used only with your connected external equipment that supports this TOOLS function. (Non-operable button for TV)
28 WEGA GATE	<p>Press to access the following through WEGA GATE:</p> <ul style="list-style-type: none"> • Select channels from the Favorites Channels you stored (see page 54). • Watch TV (see page 55). • View signals from external equipment such as DVD, VCR and others (see page 56). • View still images or movies from USB device (see page 56). • Adjust or customize TV settings (see page 56).
29 CH +/-	Press to scan through channels. To scan quickly through channels, press and hold down either +/- button.
30 F1/F2	Press to select the function of connected components. For details, see “Using Other Equipment with Your Remote Control” on page 46.

Programming the Remote Control

The remote control is preset to operate Sony brand video equipment.

Sony Equipment	Programmable Code Number
DVR	772
DVD/VCR	601 (Sony Dream System)
SAT/CABLE	801 (Sony Satellite Receiver)

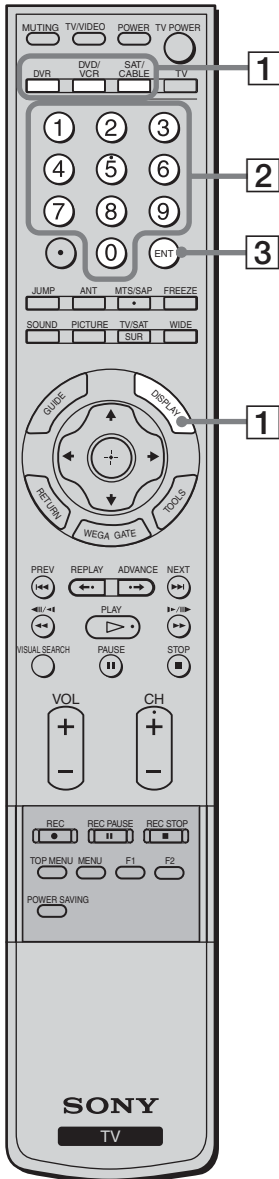

Follow the steps below to program your TV's remote control to operate the other video equipment.

Find the three-digit code for your equipment from the "Manufacturer's Codes" listed on page 45. If more than one code number is listed, try entering from the code listed first.

- 1 Press and hold the , or FUNCTION button you want to program on the remote control and press the DISPLAY button simultaneously.

The selected FUNCTION button (DVR, DVD/VCR or SAT/CABLE) will flash.
- 2 Enter the three-digit manufacturer's code number using the - buttons while the button is lit. If code is not entered within 10 seconds, you must perform the step 1 again.
- 3 Press the button.

When the programming is correct, the selected FUNCTION button will flash twice, and when not, flashes five times.

To check if the code works

Aim your TV's remote control at the equipment, and press the green button. If the equipment responds, the programming is completed. If not, try the next code listed.

- If no code is input within the above specified time, or an invalid or incorrect code number is input, the remote control automatically goes back to the previous setting.**
- In some cases, you may not be able to program your remote control to operate other equipment. In such cases, use the equipment's own remote control.**
- Dead batteries or removing the batteries may cause the programmable codes to be lost and revert back to factory settings. Reprogramming the codes may be necessary.**

Manufacturer's Codes

DVD Players

<i>Manufacturer</i>	<i>Code</i>
Sony	751
General Electric	755
Hitachi	758
JVC	756
Magnavox	757
Mitsubishi	761
Panasonic	753
Philips	757
Pioneer	752, 778
RCA/PROSCAN	755
Samsung	758
Toshiba	754
Zenith	760

DVD Changers

<i>Manufacturer</i>	<i>Code</i>
Sony	765
Panasonic	766

DVD/VCR Combo Units

<i>Manufacturer</i>	<i>Code</i>
Sony	767
Broksonic	776
JVC	775
Panasonic	777
Samsung	774
Toshiba	773
Zenith	768

HDD/DVD Combo Units

<i>Manufacturer</i>	<i>Code</i>
Sony	772, 771, 770

5.1ch DVD AV System

<i>Manufacturer</i>	<i>Code</i>
Sony (DAV)	601, 602, 603, 604

AV Receivers

<i>Manufacturer</i>	<i>Code</i>
Sony	764

VCRs

<i>Manufacturer</i>	<i>Code</i>
Sony	301, 302, 303
Admiral (M. Ward)	327
Aiwa*	338, 344
Audio Dynamic	314, 337
Broksonic	319, 317
Canon	309, 308

<i>Manufacturer</i>	<i>Code</i>
Citizen	332
Craig	302, 332
Curtis Mathes	304, 338, 309
Daewoo	341, 312, 309
DBX	314, 336, 337
Dimensia	304
Emerson	319, 320, 316, 317, 318, 341
Fisher	330, 335
Funai	338
General Electric	329, 304, 309
Go Video	322, 339, 340
Goldstar	332
Hitachi	306, 304, 305, 338
Instant Replay	309, 308
JC Penney	309, 305, 304, 330, 314, 336, 337
JVC	314, 336, 337, 345, 346, 347
Kenwood	314, 336, 332, 337
LG	332
LXI (SEARS)	332, 305, 330, 335, 338
Magnavox	308, 309, 310
Marantz	314, 336, 337
Marta	332
Memorex	309, 335
Minolta	305, 304
Mitsubishi/MGA	323, 324, 325, 326
Multitech	325, 338, 321
NEC	314, 336, 337
Olympic	309, 308
Optimus	327
Orion	317
Panasonic	308, 309, 306, 307
Pentax	305, 304
Philco	308, 309
Philips	308, 309, 310
Pioneer	308
Quasar	308, 309, 306
RCA/PROSCAN	304, 305, 308, 309, 311, 312, 313, 310, 329
Realistic	309, 330, 328, 335, 324, 338
Sansui	314
Samsung	322, 313, 321
Sanyo	330, 335
Scott	312, 313, 321, 335, 323, 324, 325, 326

<i>Manufacturer</i>	<i>Code</i>
Sharp	327, 328
Signature 2000 (M. Ward)	338, 327
SV2000	338
Sylvania	308, 309, 338, 310
Symphonic	338
Tashiro	332
Tatung	314, 336, 337
Teac	314, 336, 338, 337
Technics	309, 308
Toshiba	312, 311
Wards	327, 328, 335, 331, 332
Yamaha	314, 330, 336, 337
Zenith	331

Cable Boxes

<i>Manufacturer</i>	<i>Code</i>
Sony	230
Hamlin/Regal	222, 223, 224, 225, 226
Jerrold/General Inst./Motorola	201, 202, 203, 204, 205, 206, 207, 208, 218, 222
Oak	227, 228, 229
Panasonic	219, 220, 221
Pioneer	214, 215
Scientific Atlanta	209, 210, 211
Tocom	216, 217
Zenith	212, 213

Satellite Receivers

<i>Manufacturer</i>	<i>Code</i>
Sony	801
Dish Network	810
Echostar	810
General Electric	802
Hitachi	805
Hughes	804
Mitsubishi	809
Panasonic	803
Philips	811
RCA/PROSCAN	802, 808
Toshiba	806, 807
Samsung	812

* If an Aiwa VCR does not work even though you enter the code for Aiwa, enter the code for Sony instead.

Using Other Equipment with Your Remote Control

To operate other connected equipment with your TV, first turn to page 45 and program the necessary code. For operating video equipment, press TV/VIDEO repeatedly until you see the video input on the screen for your connected equipment. Remote control operation tips are provided below.

 **Some functions cannot be operated depending on the equipment. In that case, operate by the remote control supplied with the equipment.**

Operating a Cable Box

To Do This ...	Press ...
Activate the remote control to operate the cable box	SAT/CABLE (FUNCTION)
Turn on/off	POWER

Operating a Satellite Receiver

To Do This ...	Press ...
Activate the remote control to operate the satellite receiver	SAT/CABLE (FUNCTION)
Turn on/off	POWER
Select a channel	0-9, ENT
Change channels	CH +/-
Back to previous channel	JUMP
Display channel number	DISPLAY

Operating a VCR

To Do This ...	Press ...
Activate the remote control to operate the VCR	DVD/VCR (FUNCTION)
Turn on/off	POWER
Change channels	CH +/-
Record	●
Play	▷
Stop	■

Operating a DVD Player or DVD Changer

To Do This ...	Press ...
Activate the remote control to operate the DVD	DVD/VCR (FUNCTION)
Turn on/off	POWER
If you have a DVD changer, to skip disc	F1
Play	▷
Stop	■
Pause	(press again to resume normal playback)

To Do This ...	Press ...
Select a channel	0-9, ENT
Change channels	CH +/-
Back to previous channel	JUMP

To Do This ...	Press ...
Display SAT Guide	GUIDE
Display SAT Menu	MENU
Move highlight (cursor)	↑ ↓ ← →
Select item	⊕
Switch between the TV and satellite broadcasts	TV/SAT

To Do This ...	Press ...
Fast forward	▶▶
Rewind the tape	◀◀
Pause	(press again to resume normal playback)
Search the picture forward or backward	▶▶ or ◀◀ during playback (release to resume normal playback)

To Do This ...	Press ...
Step through different tracks of the disc	◀◀ to fast reverse or ▶▶ to fast forward the disc when pressed during playback
Step through different chapters of the disc	▶▶▶ to step forward or ◀◀◀ to step backward
Select a track directly	0-9, ENT
Display the disc menu	MENU
Display the top menu	TOP MENU
Operate the DVD menu	↑ ↓ ← →, ⊕

Operating a 5.1ch DVD AV System (Sony DAV)

To Do This ...	Press ...
Activate the remote control to operate the DVD	DVD/VCR (FUNCTION)
Turn on/off	POWER
Select other equipment connected to the DAV	F 1
Disc skip	F 2
Display the top menu	TOP MENU
Display the disc menu	MENU
Play	▷

Operating a DVD/VCR Combo Unit

To Do This ...	Press ...
Activate the remote control to operate the DVD/VCR	DVD/VCR (FUNCTION)
Turn on/off	POWER
Select the DVD Select the VCR	F 1 F 2
Display the top menu	TOP MENU
Display the disc menu	MENU
Play	▷
Stop	■
Pause	⏸

Operating an HDD/DVD Combo Unit

To Do This ...	Press ...
Activate the remote control to operate the HDD/DVD	DVR (FUNCTION)
Turn on/off	POWER
Select the HDD Select the DVD	F 1 F 2
Play	▷
Stop	■
Pause	⏸
Search the picture forward or backward	▶▶ or ◀◀ during playback

Operating an AV Receiver

To Do This ...	Press ...
Turn on/off	POWER
Master volume	VOL +/-, MUTING

To Do This ...	Press ...
Stop	■
Pause	⏸
Search the picture forward or backward	▶▶ or ◀◀ during playback
Specify the previous chapter/track Specify the next chapter/track	◀◀ ▶▶
Move highlight (cursor)	↑ ↓ ← →
Select item	⊕
Change volume	VOL +/-, MUTING

To Do This ...	Press ...
Search the picture forward or backward	▶▶ or ◀◀ during playback
Replay	◀•
Advance	•➔
Move highlight (cursor) and select (DVD)	↑ ↓ ← → ⊕
Record (VCR)	●
Change channels (VCR)	CH +/- or 0-9, ENT (using tuner)
Adjust tracking (VCR)	CH +/- (during tape playback)

To Do This ...	Press ...
Move highlight (cursor) and select	↑ ↓ ← → ⊕
Record	●
Specify the previous chapter/track Specify the next chapter/track	◀◀ ▶▶
Replay	◀•
Advance	•➔
Display the disc menu	MENU
Display the top menu	TOP MENU

To Do This ...	Press ...
Select other input connected to AV receiver	F 1

Special Buttons on the Remote Control

This TV comes with convenient features. These features can be accessed directly by pressing their buttons on your remote control.

Using the **GUIDE** Button

This TV is equipped to show program information if it is available from the station. The Program Guide lets you review program information, and select both analog and digital channels.

To display the Program Guide:

- 1 Tune your TV to a channel by using the 0-9, , and ENT buttons.
- 2 Press GUIDE on the TV's remote control. The Program Guide will appear with the currently selected program showing in the background.

Channel number,
call letters, etc.

Program title and
description,
program duration,
time remaining,
rating information,
closed-caption
availability, etc.

Selectable
channel list.

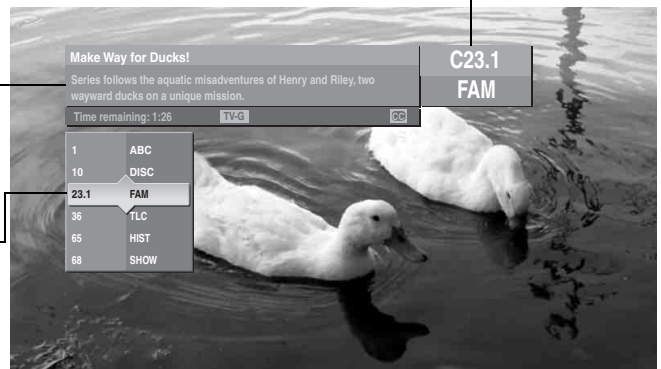

 **Program information in the guide is provided by the broadcasters. As a result, it may sometimes include only the channel number, without a program title or description.**

Using the Program Guide

The Program Guide allows you to select the channels from a drop down list. The Guide also provides information about the current program being shown on each channel.



 **Subchannels are additional channels of programming broadcast simultaneously. For example, channel 4 might include three subchannels (4.1, 4.2, 4.3) that are showing programs at the same time.**

Using the Program Options Setting

The Program Options setting allows you to customize the program settings on the currently tuned channel.

Option	Description
Alternate Video (When available)	Each program has a main video stream (the video that you see when the channel is first tuned), and may have alternate video streams. This option allows you to switch among these alternate video streams.
Alternate Audio (When available)	Each program has a main audio stream (the audio you hear when the channel is first tuned), and may have alternate audio streams. This option allows you to switch among these alternate audio streams (e.g., for different languages).

Using the WIDE Button

Wide screen mode lets you watch 4:3 normal broadcasts in several wide screen modes (16:9 aspect ratio).

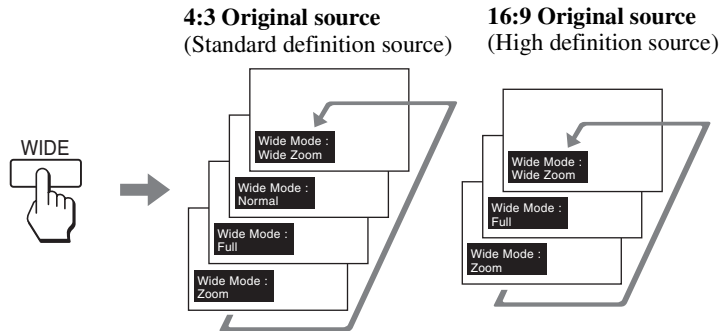

💡 When the TV receives a 720p or 1080i signal that is 4:3 aspect ratio picture with a black bar at each side, Full returns the picture to its original size.

💡 You can also access the Wide Mode settings in the Screen settings. For details, see page 77.

When the TV receives a 720p or 1080i signal, Normal cannot be selected.

Changing the wide screen mode

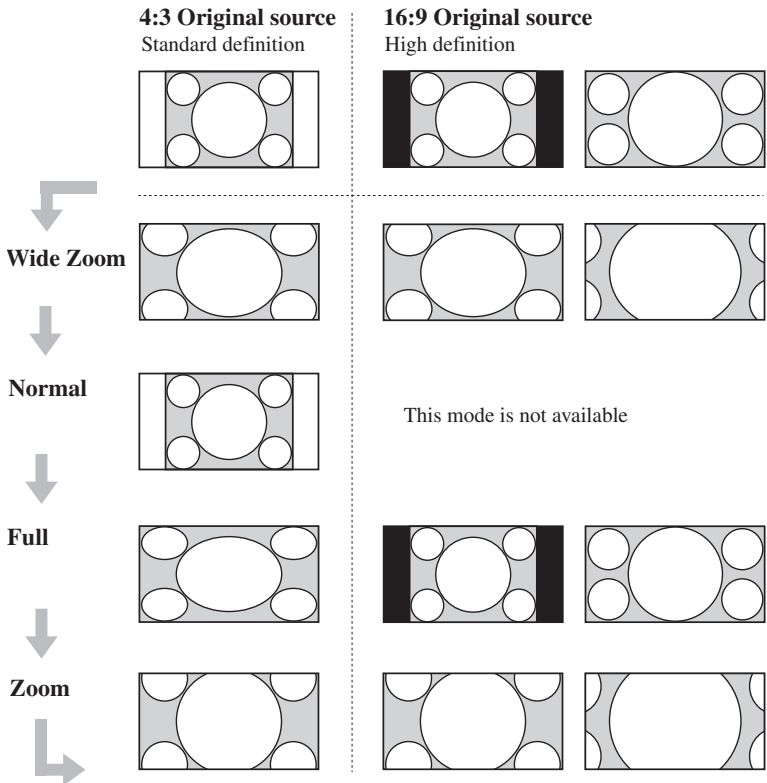

Using the JUMP Button

The JUMP button allows you to jump back and forth between the current channel and the last channel that was selected.

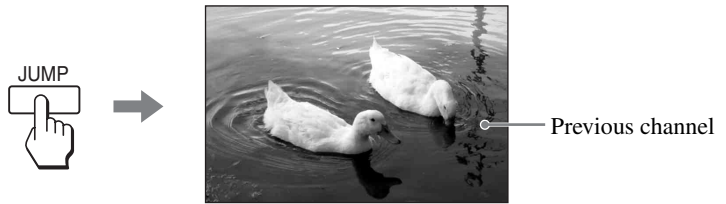

Using the FREEZE Button

The FREEZE button allows you to temporarily capture a program's picture. You can use this feature to write down information such as phone numbers, recipes, etc. To cancel FREEZE and return to normal viewing, press the FREEZE button again.

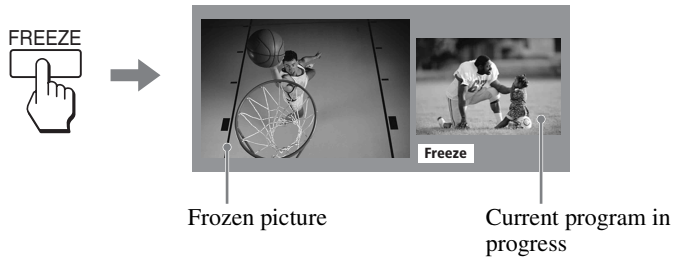

Using the POWER SAVING Button

You can reduce the power consumption of the TV by selecting Reduced. To cancel Power Saving, press the POWER SAVING button repeatedly until "Power Saving : Standard" appears.

- 💡 If you turn off the TV while the Power Saving mode is on, the mode stays on next time you turn on the TV except Picture Off.
- 💡 You can set the Power Saving mode using the Setup settings. For details, see page 86.
- 💡 When Picture Off is selected in the Power Saving mode, the PIC OFF LED lights.

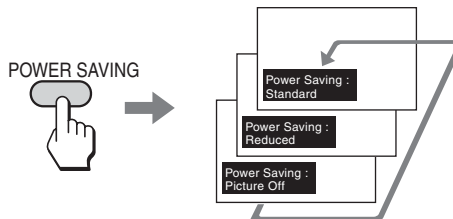



Introducing WEGA GATE

Overview of WEGA GATE

WEGA GATE provides one button access for controlling your TV. It enables you to perform a variety of tasks intuitively with a control panel on the screen rather than a variety of remote control button presses.

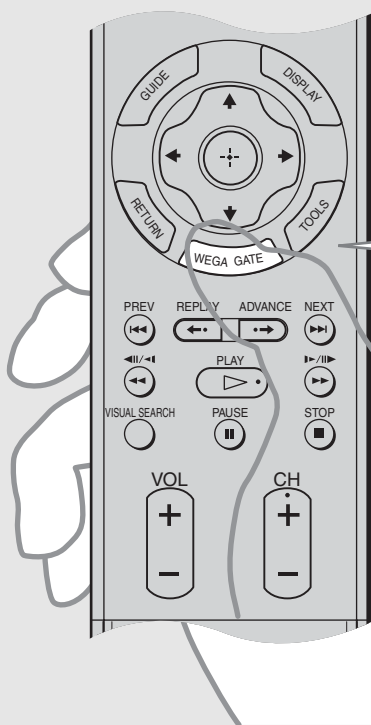
When you press , you can select from basic TV function: selecting from Favorite Channels, watching TV, viewing external equipment signals, viewing still images or movies from the USB device or adjusting TV settings.



- 1 Press  on the remote. WEGA GATE control panel appears.









- 2 Press  to highlight the item.

- 3 Press  to select.



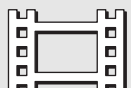





- 4 Press  to exit.

The WEGA GATE screen gives you access to the following items:

Icon	Description
 Favorites	The Favorites feature lets you select programs from a list of up to 16 favorites channels that you specify. For details, see page 54.
 Cable	The Cable feature takes you to the most recently viewed channel on the cable input. When tuned to the channel, the Program Banner and Channel number will be displayed. For details, see page 55. When this feature is active, ○ is displayed to the left of the icon.
 Antenna	The Antenna feature takes you to the most recently viewed channel on the antenna input. When tuned to the channel, the Program Banner and Channel number will be displayed. For details, see page 55. When this feature is active, ○ is displayed to the left of the icon.
 External Inputs	The External Inputs feature lets you select equipment that is connected to your TV, such as a DVD player. You can assign a label to your equipment or skip unused inputs conveniently. For details, see page 56. When this feature is active, ○ is displayed to the left of the icon.
 Photo	The Photo feature takes you to the Photo/Video Viewer to view still images from the connected USB devices. For details, see page 56.
 Video	The Video feature takes you to the Photo/Video Viewer to view movies from the connected USB devices. For details, see page 56.
 Settings	The Settings feature lets you adjust the Video, Audio, Screen, Channel, Parental Lock, Setup or Applications settings. For details, see page 56.

Navigating and Selecting Items

Use your remote control to navigate through WEGA GATE and the settings.

To Do This ...	Press ...
Display WEGA GATE control panel	Press  .
Display Settings	Press  and select Settings .
Move through Settings	Press     .
Select an option to change	Press  .
Move back to normal viewing	Press RETURN .
Select (confirm) changed setting	Press  .
Exit WEGA GATE control panel or Settings	Press  .







Using Favorites in WEGA GATE

The Favorites feature lets you select programs from a list of up to 16 favorite channels that you specify. You can create a list using the Add to Favorites option.

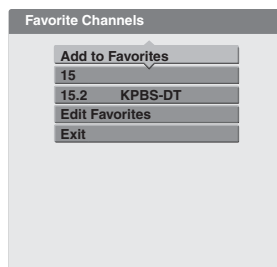
- 1 Select Favorites from the WEGA GATE control panel and press .

The Favorite Channels list appears. Make your selection.



- 2 Press / to highlight the desired channel and press .

 - To add the current channel to the list of Favorite Channels, highlight **Add to Favorites** and press .
 - When the Favorite Channels list is full, select **Edit Favorites** to remove a channel from the list or go to the **Channel settings** and select **Favorite Channels** then edit the channel.

Using Cable in WEGA GATE

The Cable feature takes you to the most recently viewed channel on the cable input. When tuned to the channel, the Program Banner and Channel number will be displayed.

Select Cable from the WEGA GATE control panel and press .

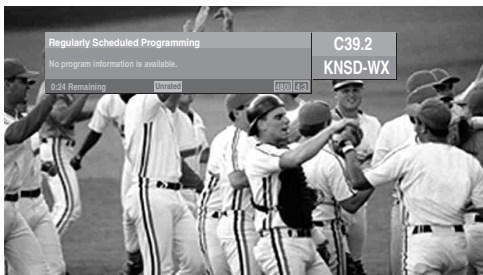



 **If you have not completed the initial channel setup (see page 31), both Cable and Antenna will tune to the lowest channel number. To run Auto Program see page 80.**

Using Antenna in WEGA GATE

The Antenna feature takes you to the most recently viewed channel on the antenna input. When tuned to the channel, the Program Banner and Channel number will be displayed.

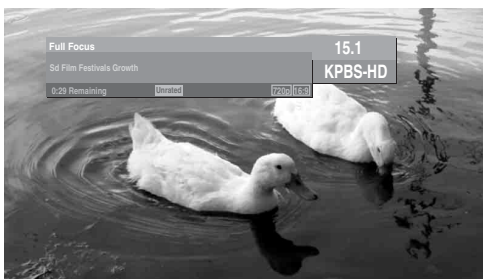
Select Antenna from the WEGA GATE control panel and press .



 **If you have not completed the initial channel setup (see page 31), both Cable and Antenna will tune to the lowest channel number. To run Auto Program see page 80.**



Using External Inputs in WEGA GATE

The External Inputs feature lets you view from a selected external input connected to your TV. You can assign a label or skip over unused inputs by selecting Edit Video Labels. Input label assignment can also be done by going to Setup settings and select Label Video Inputs (see page 85).

- 1 Select External Inputs from the WEGA GATE control panel and press .

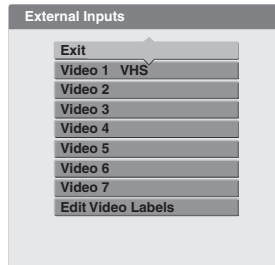
The External Inputs list appears. Make your selection.



- 2 Press  to highlight the desired external input and press .

Using Photo in WEGA GATE

The Photo feature takes you to the Photo/Video Viewer to view still images from the connected USB devices. For details, see page 57.

Using Video in WEGA GATE

The Video feature takes you to the Photo/Video Viewer to view movies from the connected USB devices. For details, see page 57.

Using Settings in WEGA GATE

The Settings feature lets you enter to the settings screen where most of advanced settings and adjustments are performed. See “Overview” on page 69.

Using the Photo/Video Viewer

About USB

You can enjoy still images and MPEG1 videos on your TV set with the Photo/Video Viewer.

Features

With the Photo/Video Viewer, you can:

- View still images (JPEG files) and still images with audio (JPEG voice memo) in a thumbnail index or Slide Show
- View movies (MPEG1 files) in a thumbnail index or Slide Show
- Set customized Slide Show options, including transitions and background audio
- Pan, zoom, and rotate photos
- Mark photos and set quantities of prints to be output when the USB device is connected to your photo printer (not supplied)
- Lock (protect) or delete files on the USB media
- Play background music

Connecting Your Camera via the USB Interface

The USB interface on your TV will support many Sony digital still cameras and video camera recorders (camcorders) in the market at the time of sale of this product. Non-Sony brand cameras and video camera recorders may not be supported due to different implementations of the USB interface.

Non-camera devices are not supported.

- Connection of unsupported devices may result in improper function of the TV or the device itself. Should improper function occur, disconnect the USB device. Should the TV fail to function properly after the USB device has been disconnected, unplug the TV, and plug it back in to restore proper function.

Sony recommends that you back up any files saved to your USB devices' internal memory or portable memory device, prior to using the TV's Photo/Video Viewer. Sony cannot accept responsibility in the event that such files are lost or damaged. Be sure to do the following to prevent the possible loss of your files.

- Power off the TV (power button on the right side panel of the TV or on the remote control) before connecting or disconnecting the USB device.
- Power off the USB device when switching between like memory devices (e.g. when switching Memory Sticks cards).
- Power off the USB device when switching between different memory devices (e.g. when switching between a Memory Stick card and CompactFlash card, or between a Memory Stick card and the built-in memory of the USB devices).



Remember to disconnect the USB device when it's not in use.





Not all products with USB connectors may communicate with each other due to variations in the manufacturer's implementation.

For more information about handling USB media, see "Notes on Using USB Media" on page 68.

Connecting the USB Cable

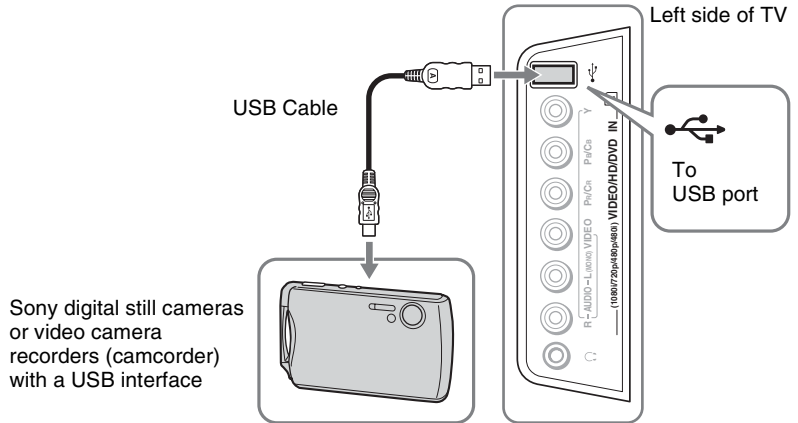
Connect your USB device to the TV using a USB cable. The USB port for the TV is on the left side panel (when viewed from the front of the TV) of the TV and is identified by the USB symbol as shown below.



 **Before connecting and disconnecting the USB connector, be sure to turn off the TV (power button on the right side or the remote control), otherwise USB media may not be displayed or data may be damaged.**

File Compatibility

The Photo/Video Viewer is compatible with JPEG images taken with Sony digital still cameras and MPEG1* movies taken with Sony digital cameras and camcorders. To be viewable in the Photo/Video Viewer, files must have the following file name extensions:

* Some variations of MPEG1 movies may not play back correctly.

File Type	Supported File Name Extensions
JPEG	.jpg/.jpeg
MPEG1	.mpg/.mpeg

 **If your digital still camera has an internal memory, you can view the files in the internal memory but cannot edit them. To edit the files, make a copy to a media such as Memory Stick in your digital still camera.**

Using the Photo/Video Viewer Index





Turn on the TV and connect your USB device that contains the photo or movie files you want to view. To connect your USB device, see “Connecting the USB Cable” on page 58.

Press  on the remote control or on the right side panel, select Photo or Video in the WEGA GATE control panel.

The Photo/Video Viewer Index appears, which displays thumbnail images of the files stored on the USB media.



About the Icons on the Thumbnail Images

-  Indicates the thumbnail is a movie (MPEG1) file instead of a photo (JPEG) file.
-  Indicates the thumbnail is locked. Locked files cannot be changed or deleted. For details, see “Protect” on pages 62 and 65.
-  Indicates that the photo is marked to be printed.
-  Indicates that the photo has an associated voice memo.

Using the Photo/Video Viewer Index

The following describes how to use the Photo/Video Viewer Index.

To Do This ...	Do This ...
Move the highlight to a photo, voice memo (🎙️), or movie (🎬) thumbnail	Press ↑ ↓ ← → .
Display the highlighted photo, voice memo, or movie file in full screen	Press ⊕ . For details, see “Viewing Photos” on page 61 and “Playing Movies” on page 64.
Display the next page of thumbnails	1 Press ↓ to select ▼ . 2 Press ↓ to display the next page of thumbnails.
Display the previous or next page of thumbnails	1 Press ↓ to select ▼ . 2 Press ← to select ◆ . 3 To go to the previous page, press ↑ . To go to the next page, press ↓ .
Use the USB menu bar to access additional options	1 Press ↓ to select ▼ . 2 Press ← or → to select Slide Show, Contents, or USB Media . 3 Press ↑ or ↓ to select the option you want to change. For details on these options, see “Photo/Video Viewer Index Menu Bar Options” on page 66.
Move the highlight from the USB menu bar back to the thumbnails	1 Press ← or → to select ▼ . 2 Press ↑ to return to the currently displayed thumbnails, or ↓ to display the next page of thumbnails.
Exit Photo/Video Viewer	Press ↓ or → to select Exit , then press ⊕ .

Viewing Photos

When you select a photo from the Photo/Video Viewer Index (described on page 59), it displays as shown below, with the following controls.

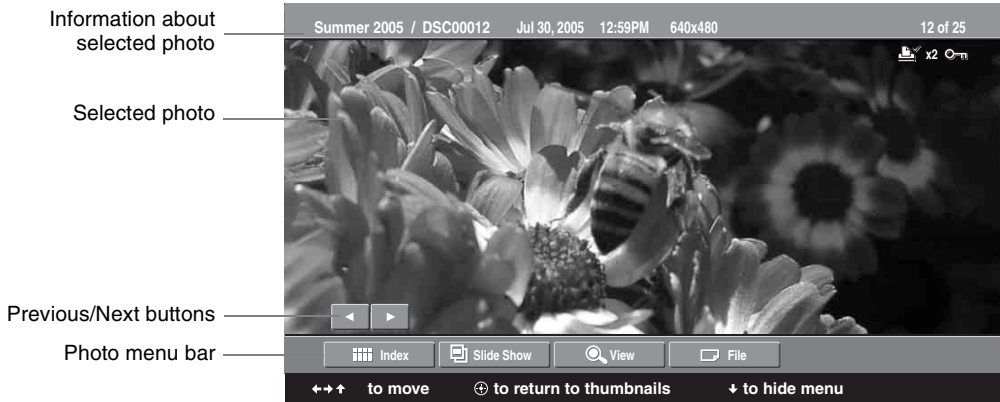



 **JPEGs captured using a digital video camera may appear to display motion in full screen. This is a result of the way digital video cameras record still images, and is not a result of a malfunction with the TV.**

Photo Controls

 When the menu is hidden, press ◀ or ▶ to go to the previous or next photo.

To Do This ...	Do This ...
Display the previous or next file on the USB media	Press ↑ to highlight the ◀ ▶ (Previous/Next) button. Then press ◀ to go to the previous file, or ▶ to go to the next file.
Hide the Photo menu bar, displaying only the photo	With the highlight in the Photo menu bar, press ↓.
Display the hidden Photo menu bar	Press ↑.
Play the JPEG voice memo (🗣️ files only)	Highlight ▶ (Play) and then press ⏸. To pause the voice memo, highlight ⏸ (Pause) and then press ⏸.
Display the Photo/Video Viewer Index again	Press ◀ or ▶ to highlight Index in the Photo menu bar and press ⏸. For details on the Photo/Video Viewer Index, see page 60.
Access additional options in the Photo menu bar	See “Photo Menu Bar Options” on page 62.

Photo Menu Bar Options

The Photo menu bar lets you access additional photo viewing options.

To access the Photo menu bar

- 1 Press **←** or **→** to select Index, Slide Show, View, or File.
- 2 Use **↑** **↓** **←** **→** to select the desired option.

<i>Option</i>	<i>Description</i>
Index	Displays the Photo/Video Viewer Index, with the highlight on the currently displayed photo's thumbnail. For details, see "Using the Photo/Video Viewer Index" on page 59.
Slide Show	Displays the Slide Show menu. For details, see "Slide Show Menu Options" on page 66.
View	Zoom/Pan Allows you to magnify and pan across the photo. For details, see "Using Zoom and Pan" on page 63.
	Rotate Allows you to rotate the photo in 90 degree increments clockwise or counterclockwise. For details, see "Using Rotate" on page 63.
File	Delete Deletes the JPEG file from the USB media. You cannot delete a JPEG file that has been protected.
	Print Quantity Allows you to indicate the number of prints to make of the specific photo when the USB device is connected to a compatible photo printer (not supplied).
	Protect Allows you to protect the JPEG file from any changes. When a JPEG file is protected, it cannot be rotated or deleted. Select On or Off .

💡 JPEG files that are protected are indicated by the Lock  icon.

💡 The Print Quantity feature is also known as DPOF (Digital Print Order Format).

Using Zoom and Pan

To Zoom and Pan a photo

- 1 In the Photo menu bar, press ◀ or ▶ to highlight View.
- 2 Press ▲ or ▼ to highlight Zoom/Pan and press ⊕.
- 3 Specify the zoom center point by using ▲ ▼ ◀ ▶; then press ⊕ to set the center.

The Zoom and Pan controls are displayed.

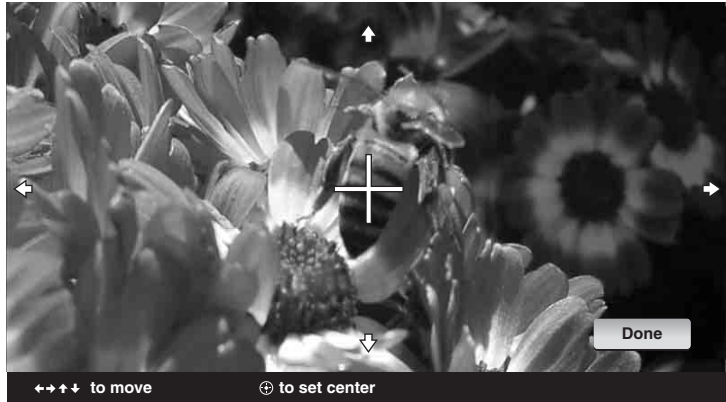

To Do This ...

Zoom in (increase magnification) or out (decrease magnification)

Pan (left, right, up, down)

Exit the Zoom/Pan controls

Do This ...

Press ◀ or ▶ to highlight Zoom 1.00. Then press ▲ to zoom in or ▼ to zoom out.

(You can use Pan only when the photo is magnified using Zoom.)

Press ◀ or ▶ to highlight Pan and press ⊕. Then press ◀ ▶ ▲ ▼ to pan around the photo.

To stop using Pan, press ⊕.

Press ◀ or ▶ to highlight Exit and press ⊕.

Using Rotate

🔒 You cannot rotate a photo that has been protected. See “Protect” on page 62.

To Rotate a photo

- 1 In the Photo menu bar, press ◀ or ▶ to highlight View.
- 2 Press ▲ or ▼ to highlight Rotate.
- 3 To rotate clockwise, press ▲ or ▼ to highlight Clockwise and press ⊕. To rotate counterclockwise, press ▲ or ▼ to highlight Counterclockwise and press ⊕. The photo is rotated 90 degrees each time you press ⊕.

Playing Movies

When you select a movie from the Photo/Video Viewer Index (described on page 59), it displays as shown below, with the following controls.



 **Some USB devices/media may transfer video files at an insufficient rate to allow for smooth video playback with some types of files.**

Movie Controls

 The quality of the movie when enlarged depends on the resolution of the MPEG1 file. See your camera's instruction manual for details.

To Do This ...	Do This ...
Enlarge the movie window	Press ↑ or ↓ to highlight Enlarge , and then press + . To display the movie controls again, press + .
Play the movie with the movie controls displayed	Press ↑ or ↓ to highlight ▶ (Play) and then press + .
Pause the movie	While the movie is playing, the ▶ button changes to the ⏸ (Pause) button. Press ↑ or ↓ to highlight ⏸ (Pause) and then press + .
Display the previous or next file on the USB media	Press ↑ or ↓ to highlight the ◀▶ (Previous/Next) button. Then press ← to go to the previous file, or → to go to the next file.
Hide the Movie menu bar, displaying only the movie	With the highlight in the Movie menu bar, press ↓ .
Display the hidden Movie menu bar	Press ↑ .
Access additional options in the Movie menu bar	See "Movie Menu Bar Options" on page 65.

Movie Menu Bar Options

To access the Movie menu bar

- 1 Press ◀ or ▶ to select Index, Slide Show, or File.
- 2 Press ▲ or ▼ to select the desired option.

Option	Description	
Index	Displays the Photo/Video Viewer Index, with the highlight on the currently displayed movie's thumbnail. For details, see "Using the Photo/Video Viewer Index" on page 59.	
Slide Show	Displays the Slide Show menu. For details, see "Slide Show Menu Options" on page 66.	
File	Delete	Deletes the MPEG1 file from the USB media. You cannot delete an MPEG1 file that has been protected.
	Protect	Allows you to protect the MPEG1 file from any changes. When an MPEG1 file is protected, it cannot be deleted. Select On or Off.

⚠ MPEG1 files that are protected are indicated by the Lock  icon.

Photo/Video Viewer Index Menu Bar Options

Slide Show Menu Options

The Slide Show menu includes the following options:

Option	Description
Repeat	On Slide Show continuously loops.
	Off Slide Show plays once through all files and ends.
File Information	Determines whether file information is displayed. Select On or Off .
Slide Advance	Allows you to specify when to advance to the next slide.
	Fast Slide advances after about 3 seconds.
	Medium Slide advances after about 6 seconds.
	Slow Slide advances after about 12 seconds.
Manual advance	Slide advances only after you press ◀ or ▶.
Transition Effect	Allows you to select an effect to be used when advancing to the next file in the Slide Show.
Music	Allows you to select background audio to play during the Slide Show.
	Off No additional background audio is played during the Slide Show. Audio that is associated with the JPEG or MPEG1 files will play.
	Play Device Plays all MP3 files on the USB media. The Piano (Built-in music) MP3 file is not played.
	Piano (Built-in music) Plays the MP3 file stored in the TV's internal memory.
	(List of MP3 Files) Displays a list of all MP3 files found at the top level (root) of the USB media. To show additional MP3 files stored in other folders on the USB media, select Complete List .
Complete List	Displays a list of all available MP3 files. The list is sorted in alphabetical order, grouped by folder.
Start	Starts the Slide Show.

💡 Some JPEG files may take longer to display than others, which may make it seem longer than the interval you selected for Slide Advance.

💡 The Slide Show menu is the same whether you select it from the Photo/Video Viewer Index (page 59), Photo (page 61), or Movie (page 64) menus.







💡 When you select Complete List, it may take a moment to display the list of all MP3 files.

Contents Menu Options

 Selecting Photo in WEGA GATE will show still images (JPEG files), and Video will show movies (MPEG1 files), by setting a contents filter that selectively shows only photos or movies.

 The Rotate and Protect functions do not change the file's modification date.

The Contents menu includes the following options:

Option	Description								
Filter	Allows you to selectively display specific file types within the selected folder.								
	<table border="0"> <tr> <td>Show Photos and Movies</td> <td>Displays all readable files.</td> </tr> <tr> <td>Show Photos Only</td> <td>Displays only photo (JPEG) files.  Set by default if Photo is selected from WEGA GATE menu.</td> </tr> <tr> <td>Show Movies Only</td> <td>Displays only movie (MPEG1) files.  Set by default if Video is selected from WEGA GATE menu.</td> </tr> <tr> <td>Show All Print Marks</td> <td>Displays all JPEG files marked with the Print Mark feature, regardless of the currently selected folder. For details, see "Print Quantity" on page 62.</td> </tr> </table>	Show Photos and Movies	Displays all readable files.	Show Photos Only	Displays only photo (JPEG) files.  Set by default if Photo is selected from WEGA GATE menu.	Show Movies Only	Displays only movie (MPEG1) files.  Set by default if Video is selected from WEGA GATE menu.	Show All Print Marks	Displays all JPEG files marked with the Print Mark feature, regardless of the currently selected folder. For details, see "Print Quantity" on page 62.
	Show Photos and Movies	Displays all readable files.							
	Show Photos Only	Displays only photo (JPEG) files.  Set by default if Photo is selected from WEGA GATE menu.							
	Show Movies Only	Displays only movie (MPEG1) files.  Set by default if Video is selected from WEGA GATE menu.							
Show All Print Marks	Displays all JPEG files marked with the Print Mark feature, regardless of the currently selected folder. For details, see "Print Quantity" on page 62.								
File Order	Allows you to change the order in which the USB files are displayed.								
	Date Order	Displays files in chronological order by modification date.							
	Date Order Reverse	Displays files in reverse chronological order by modification date.							
	Alphabetical	Displays files in alphabetical order by filename.							
Select Folder	Allows you to select different folders to view in the Photo/Video Viewer.								
	Digital Camera Folders	Selects all folders within the directories defined by the DCF rules used by Sony digital cameras (see page 68). JPEG and MPEG1 files in those directories are recognized even if they do not conform to the DCF file naming rules.							
	Select a Folder	Allows you to access individual folders on the USB media.							

USB Media Menu

The USB Media menu displays the current status of the USB media, including total capacity, used capacity, and free capacity.

Notes on Using USB Media

About DCF File Names

Most Sony brand digital still and video cameras automatically record still photo and movie files using DCF compliant directory and file names.

If you selected the Digital Camera Folders option, as described on page 67, you might want to have your digital camera's instruction manual handy in order to check how files and directories are organized for your specific model of digital camera.

DCF stands for "Design Rules for Camera File Systems," which are specifications established by the Japan Electronics and Information Technology Industries Association (JEITA: formerly JEIDA).

Only DCF compliant directory and file names can be displayed on this TV such as illustrated below.

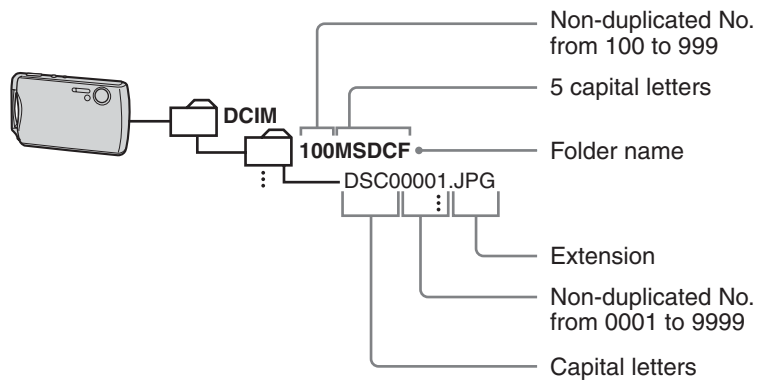

Using the Settings

Overview

The Settings give you access to the following features:

Depending on the signal tuned, you may see different Setting options on your screen. Settings displayed here are with the 720p signal.

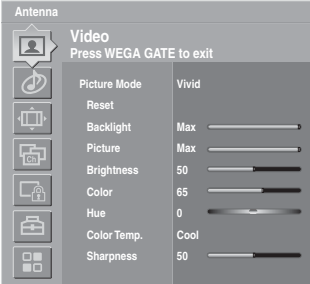
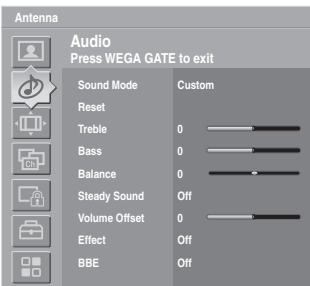
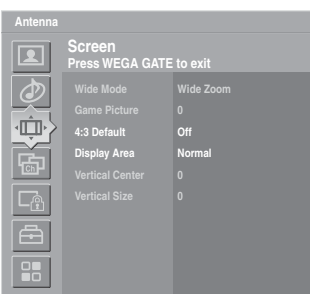
Settings	Allows you to set/change	
<p>Video</p> 	<ul style="list-style-type: none"> Picture Mode (page 71) Reset (page 71) Backlight (page 71) Picture (page 71) Brightness (page 71) Color (page 71) Hue (page 71) Color Temp. (page 72) Sharpness (page 72) 	<ul style="list-style-type: none"> Noise Reduction (page 72) DRC Mode (page 72) DRC Palette (page 72) Advanced Video (page 73)
<p>Audio</p> 	<ul style="list-style-type: none"> Sound Mode (page 74) Reset (page 74) Treble (page 74) Bass (page 74) Balance (page 74) Steady Sound (page 74) Volume Offset (page 74) Effect (page 74) BBE (page 74) 	<ul style="list-style-type: none"> MTS (page 75) Speaker (page 75) Audio Out (page 75) A/V Sync (page 75)
<p>Screen</p> 	<ul style="list-style-type: none"> Wide Mode (page 77) Game Picture (page 77) 4:3 Default (page 78) Display Area (page 78) Vertical Center (page 78) Vertical Size (page 78) 	

(Continued)

Settings *Allows you to set/change*

Channel

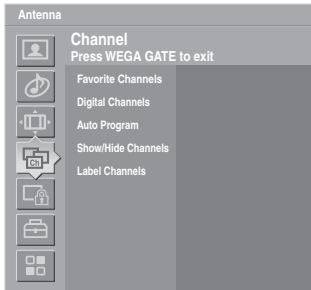

- Favorite Channels (page 80)
- Digital Channels (page 80)
- Auto Program (page 80)
- Show/Hide Channels (page 80)
- Label Channels (page 81)

Parental Lock

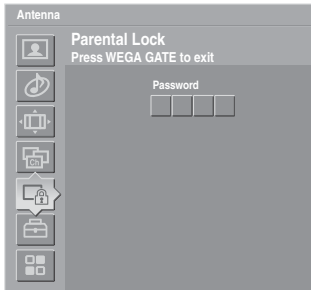

- Parental Lock (page 82)
- Change Password (page 82)
- Select Country (page 82)

Setup

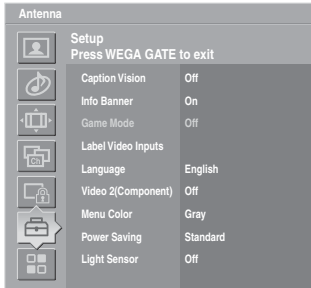

- Caption Vision (page 85)
- CineMotion (page 86)
- Info Banner (page 85)
- Game Mode (page 85)
- Label Video Inputs (page 85)
- Language (page 86)
- Video 2 (Component) (page 86)
- Menu Color (page 86)
- Power Saving (page 86)
- Light Sensor (page 86)

Applications

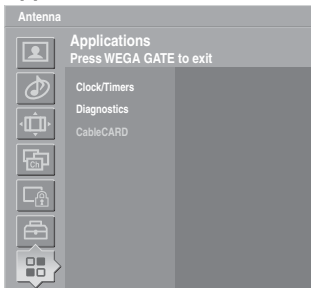

- Clock/Timers (page 90)
- Diagnostics (page 91)
- CableCARD (page 91)

Accessing the Video Settings

1. Press WEGA GATE.....



2. Select Settings.....



3. Highlight.....



4. Press to select.....



To highlight an option and to change settings, press
 ▲ ▼ ◀ ▶.

Press  to confirm the selection.



To exit Video, press .



Selecting Video Options

 To change from one Picture Mode to another, use PICTURE on the remote control.

The Video settings includes the following options:

Option	Description
Picture Mode	Vivid Select for enhanced picture contrast and sharpness.
<i>Customized picture viewing</i>	Standard Select for standard picture settings. Recommended for home entertainment.
	Custom Select to display a picture with minimum enhancement.
	 You can alter the Video setting (Picture, Brightness, Color, etc.) for each Picture Mode and each video input.
	 You may set up a Picture Mode (Vivid, Standard, Custom) independently for each Video input (Video 1- Video 6, including the Antenna input). Your Picture Mode settings are automatically saved after each selection. This allows you to customize the Picture Mode setting for each type of signal source.
Reset	Select OK to reset all settings and adjustments to the default setting (except for Advanced Video).
Backlight	Adjust to brighten or darken the backlight.
Picture	Adjust to increase picture contrast and deepen the color or decrease picture contrast and soften the color.
Brightness	Adjust to brighten or darken the picture.
Color	Adjust to increase or decrease color intensity.
Hue	Adjust to increase or decrease the green tones.

(Continued)

Option	Description						
Color Temp.	Choose from four color temperatures:						
White adjustment	<table border="1"> <tr> <td>Cool</td> <td>Select to give the white colors a blue tint.</td> </tr> <tr> <td>Neutral</td> <td>Select to give the white colors a neutral tint.</td> </tr> <tr> <td>Warm 1/2</td> <td>When selected Custom in Picture Mode, select to give the white colors a red tint.</td> </tr> </table>	Cool	Select to give the white colors a blue tint.	Neutral	Select to give the white colors a neutral tint.	Warm 1/2	When selected Custom in Picture Mode, select to give the white colors a red tint.
Cool	Select to give the white colors a blue tint.						
Neutral	Select to give the white colors a neutral tint.						
Warm 1/2	When selected Custom in Picture Mode, select to give the white colors a red tint.						
Sharpness	Adjust to sharpen or soften the picture.						
Noise Reduction	Select to reduce the noise level of connected equipment. This also reduces the noise level to the signal from the VHF/UHF jack. Select from Auto, High, Medium, Low and Off.						
DRC Mode	<table border="1"> <tr> <td>High Density</td> <td>Creates a high-resolution picture with 4 × density, for high quality sources (i.e., DVD player, satellite receiver).</td> </tr> <tr> <td>Progressive</td> <td>Recommended for moving pictures.</td> </tr> <tr> <td>Off</td> <td></td> </tr> </table> <p> DRC Mode is not available when Game Mode is On or using the Freeze feature or the Photo/Video Viewer; also not available when watching 480p, 720p or 1080i sources.</p>	High Density	Creates a high-resolution picture with 4 × density, for high quality sources (i.e., DVD player, satellite receiver).	Progressive	Recommended for moving pictures.	Off	
High Density	Creates a high-resolution picture with 4 × density, for high quality sources (i.e., DVD player, satellite receiver).						
Progressive	Recommended for moving pictures.						
Off							

DRC Palette Allows you to customize the level of detail (Reality) and smoothness (Clarity) for up to three input sources. For example, you can create one Custom setting to optimize your cable input's picture, and create another to optimize your DVD player's picture. You can switch among the three Custom settings.

- 1 Press the arrow buttons to highlight Custom then press . The DRC palette appears.

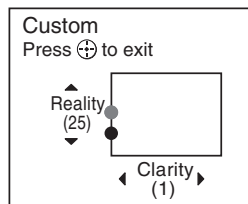

- 2 Press the arrow buttons to adjust the position of the marker (●). As you move the ● higher along the Reality axis, the picture becomes more detailed. As you move the ● to the right along the Clarity axis, the picture becomes smoother.
- 3 To save the setting, press .

 **DRC Palette is not available when Game Mode is On, Noise Reduction is set to Auto, DRC Mode is Off or using the Freeze feature or the Photo/Video Viewer; also not available when watching 480p, 720p or 1080i sources.**

Option	Description
Advanced Video Program Available in “Custom Picture Mode”	Select Program to choose among the options: Black Corrector (High/Medium/Low/Off), Contrast Enhancer (High/Low/Off), Gamma (Max/High/Medium/Low/Off), Clear White (High/Low/Off), Live Color (High/Medium/Low/Off), Color Space (Wide/Normal).

Selecting PC Video Options

To display the PC screen:

Press TV/VIDEO repeatedly on the remote control until Video 7 (PC) appears.



You can change the settings for the PC input while the TV is displaying the PC screen.

The PC Input Video setting includes the following options:

Option	Description
Display Mode	Video Select to view video images.
	Text Select to view text, charts or tables.
Reset	Select to restore the factory default settings.
Backlight	Select to adjust the brightness of the screen.
Picture	Adjust to increase or decrease picture contrast.
Brightness	Adjust to brighten or darken the picture.
Color Temp.	Choose from four color temperatures:
	Cool Select to give the white colors a blue tint.
	Neutral Select to give the white colors a neutral tint.
	Warm 1/2 Select to give the white colors a red tint.

Accessing the Audio Settings

1. Press WEGA GATE.....



2. Select Settings.....







3. Highlight.....



4. Press to select.....



To highlight an option and to change settings, press
   .

Press  to confirm the selection.

To exit Audio, press .

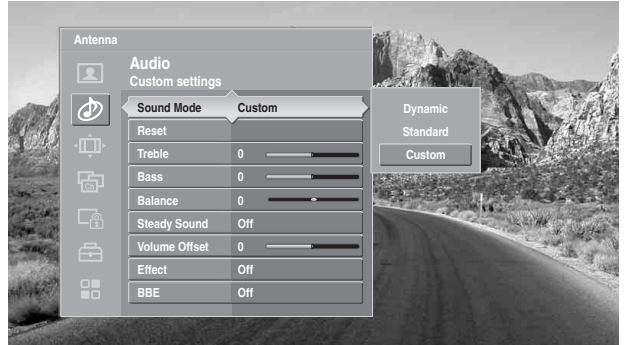



Selecting Audio Options

 To change from one Sound Mode option to another, use SOUND on the remote control.

 TruSurround XT attempts to create the same surround effect produced by a multichannel system using the left and right speakers.



The Audio settings includes the following options:

Option	Description
Sound Mode	Dynamic Select to enhance treble and bass.
	<i>Customized sound listening</i> Standard Suitable for spoken dialog.
	Custom Flat setting.
Reset	Reset the following options to the default setting: Treble, Bass, Balance, Steady Sound, Volume Offset, Effect and BBE.
Treble	Adjust to increase or decrease higher-pitched sounds.
Bass	Adjust to increase or decrease lower-pitched sounds.
Balance	Adjust to emphasize left or right speaker balance.
Steady Sound	On Select to stabilize the volume across all programs and commercials.
	Off Select to turn off Steady Sound.
Volume Offset	Adjust to increase or decrease the sound level of the current input (TV or video input) relative to other inputs.
Effect	TruSurround XT* Select for surround sound (for stereo programs only).
	Simulated Adds a surround-like effect to mono programs.
	 Simulated function is using SRS 3D Mono.
	Off Select for normal stereo or mono reception.
BBE**	Select to give sound more impact by compensating for phase effects in speakers. Select from High, Low, and Off.

*: TruSurround XT, SRS 3D Mono and the  symbol are trademarks of SRS Labs, Inc. TruSurround XT and SRS 3D Mono technologies are incorporated under license from SRS Labs, Inc.

***: Licensed by BBE Sound, Inc. under USP4638258, 4482866. "BBE" and BBE symbol are trademarks of BBE Sound, Inc.

 To change from one MTS option to another, use MTS/SAP on the remote control.

Option	Description
MTS <i>Enjoy stereo, bilingual and mono programs</i>	Stereo Select for stereo reception when viewing a program broadcast in stereo.
	Auto SAP Select to automatically switch the TV to second audio programs when a signal is received. If no SAP signal is present, the TV remains in Stereo mode.
	Mono Select for mono reception. Use to reduce noise during weak stereo broadcasts.
 MTS is available only for analog programs.	
Speaker	On Select to turn on the TV speakers.
	Off Select to turn off the TV speakers and listen to the TV's sound only through your external audio receiver and speakers.
 The MUTING button on your remote control is available when Audio Out is set to Variable, and becomes nonfunctional when set to Fixed.	
Audio Out <i>Easy control of volume adjustments</i>	This option can be set only when the Speaker option is set to Off.
	Variable The TV's speakers are turned off and the audio output from your audio system can still be controlled by the TV's remote control.
	Fixed The TV's speakers are turned off and the audio output of the TV is fixed. Use your audio receiver's volume control to adjust the volume (and other audio settings) through your audio system.
A/V Sync	Off/1/2/3 Use this option to make adjustments to audio and video synchronization when you have external equipment connected to OPTICAL OUT of the TV. Select Off (factory default setting) to make no adjustments. Select 1, 2 or 3 to adjust so that the video and audio from your connected external equipment are synchronized.

Selecting PC Audio Options

To display the PC screen:

Press TV/VIDEO repeatedly on the remote control until Video 7 (PC) appears.

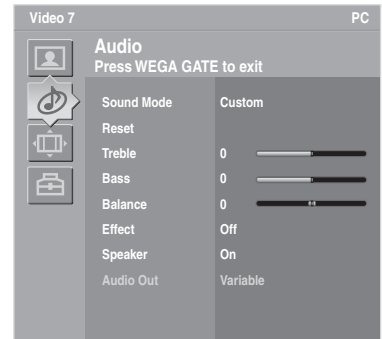

 You can change the settings for the PC input while the TV is displaying the PC screen.

The PC Input Audio setting includes the following options:

Option	Description
Sound Mode	Dynamic Select to enhance treble and bass.
	Standard Suitable for spoken dialog.
	Custom Flat setting.
Reset	Select to restore the factory default settings
Treble	Adjust to increase or decrease higher-pitched sounds.
Bass	Adjust to increase or decrease lower-pitched sounds.
Balance	Adjust to emphasize left or right speaker balance.
Effect	TruSurround XT Select for surround sound (for stereo programs only).
	Simulated Adds a surround-like effect to mono programs.
	 Simulated function is using SRS 3D Mono.
Speaker	Off Select for normal stereo or mono reception.
	On Select to turn on the TV speakers.
Audio Out <i>Easy control of volume adjustments</i>	Off This option can be set only when the Speaker option is set to Off.
	Variable The TV's speakers are turned off and the audio output from your audio system can still be controlled by the TV's remote control.
	Fixed The TV's speakers are turned off and the audio output of the TV is fixed. Use your audio receiver's volume control to adjust the volume (and other audio settings) through your audio system.

Accessing the Screen Settings

1. Press WEGA GATE.....



2. Select Settings.....



3. Highlight.....



4. Press to select.....



To highlight an option and to change settings, press
 ▲ ▼ ◀ ▶.

Press  to confirm the selection.



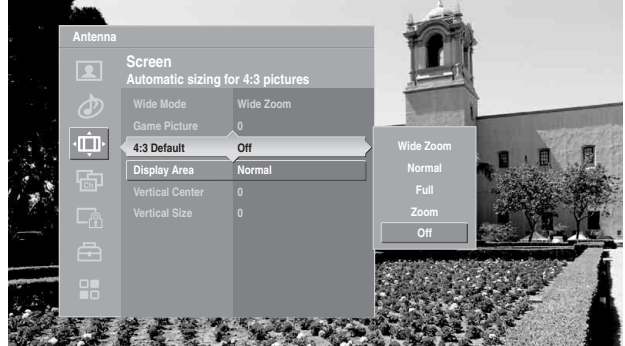

To exit Screen, press .



Selecting Screen Options

 Wide Mode is unavailable while in the Freeze feature (page 51) or using the Photo/Video Viewer.

The Screen settings includes the following options:







Option	Description
Wide Mode <i>Select a Wide Mode to use for 4:3 sources</i>	Wide Zoom Select to enlarge the 4:3 picture to fill the 16:9 screen, keeping the original image as much as possible.
Normal	Select to return the 4:3 picture to its original size and aspect ratio.
 Normal is not available when you are watching 720p or 1080i sources.	
Full	Select to enlarge the 4:3 picture horizontally only, to fill the display area.
Zoom	Select to proportionally enlarge 1080i and 720p sources. For 480p and 480i sources, Zoom will vertically stretch the image to fill the screen.
 To change from one Wide Mode setting to another, use the WIDE button on the remote control (see page 43).	
Game Picture	Allows you to move the position of the picture left and right in the window. (This feature also allows you to adjust the picture from any connected equipment.) Select while watching the picture to be adjusted. The TV stores the position in memory for each input. Press ◀ or ▶ and press  to choose a correction.
 Not available in Full and Normal modes when sources are in 720p or 1080i, or using the Photo/Video Viewer.	

(Continued)

Using the Settings

 4:3 Default functions only when the TV receives 480i or 480p signals.

 If 4:3 Default option is set to anything but Off, the Wide Mode setting changes only for the current channel. When you change channels (or inputs), Wide Mode is automatically replaced with the 4:3 Default setting for 4:3 sources. To retain the current Wide Mode setting as channels and inputs are changed, set 4:3 Default to Off.

Option	Description	
4:3 Default <i>Select the default Screen Mode to use for 4:3 sources</i>	Wide Zoom	Select to enlarge the 4:3 picture to fill the 16:9 screen, keeping the original image as much as possible.
	Normal	Select to return the 4:3 picture to its original size.
	Full	Select to enlarge the 4:3 picture horizontally only, to fill the display area.
	Zoom	Select to enlarge the picture horizontally and vertically to an equal aspect ratio that fills the wide screen.
	Off	Select to continue using the current Wide Screen Mode setting when the channel or input is changed.
Display Area	Select Normal to return to the default display area. Select -1 or -2 to keep the edge of the picture out of screen.	
Vertical Center	Allows you to move the position of the picture up and down in the window. (Available only in Zoom mode.) Press  or  and press  to choose a correction.	
Vertical Size	Allows you to adjust the vertical size of the picture. (Available only in Zoom mode.) Press  or  and press  to choose a correction.	

Selecting PC Screen Options

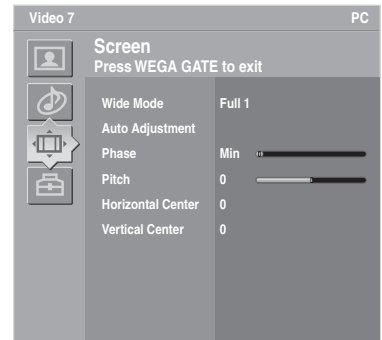

To display the PC screen:

Press TV/VIDEO repeatedly on the remote control until Video 7 (PC) appears.





 You can change the settings for the PC input while the TV is displaying the PC screen.

The PC Input Screen setting includes the following options:





Option	Description	
Wide Mode	Normal	Select to display the picture in its original size.
	Full 1	Select to enlarge the picture to fill the display area, keeping its original horizontal-to-vertical aspect ratio.  A black frame will appear on the surrounding of the picture.
	Full 2	Select to enlarge the picture to fill the display area.  A black frame will appear on the surrounding of the picture.
	Zoom	Select to enlarge the picture horizontally and vertically to an equal aspect ratio that fills the wide screen.
Auto Adjustment	Select to automatically adjust the display position and phase of the picture when the TV receives an input signal from the connected PC. Note that Auto Adjustment may not work well with certain input signals. In such cases, manually adjust the options below.	
Phase	Select to adjust the phase when the screen flickers.	
Pitch	Select to adjust the pitch when the picture has unwanted vertical stripes.	
Horizontal Center	Select to adjust the horizontal position of the picture. Allows you to move the picture left and right in the window. Press ◀ or ▶ and press (+) to choose a correction.	
Vertical Center	Select to adjust the vertical position of the picture. Allows you to move the picture up and down in the window. Press ◀ or ▶ and press (+) to choose a correction.	





 When there is no signal input, no options can be selected.

 Select Zoom in the Wide Mode option to display movies and other content on DVD, using the entire viewable area of the screen.

 Adjustment range for Horizontal Center and Vertical Center is adjusted according to the input signal.

Accessing the Channel Settings

1. Press WEGA GATE..... 
2. Select Settings..... 
3. Highlight..... 
4. Press to select..... 

To highlight an option and to change settings, press    .

Press  to confirm the selection.

To exit Channel, press .

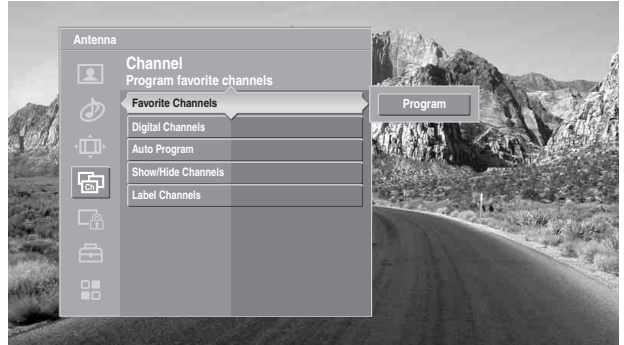

Selecting Channel Options





 Also, you can access the Favorite Channels list on the WEGA GATE control panel.

 Channels that you set to be hidden can be accessed only with the 0-9 buttons.

The Channel settings includes the following options:

Option	Description
Favorite Channels	Lets you set up a list of your favorite channels. For details, see “Using Favorites in WEGA GATE” on page 54.
Digital Channels Add	Select to add digital channels.
Auto Program	Automatically sets up the channel list on the TV for all receivable channels for the current input (VHF/UHF or CABLE). Select to start the Auto Program.
 Auto Program may take a while (20 to 50 minutes) to complete. A progress bar will display the approximate progress of the Auto Program and Digital Channels/Add sequences.	





Show/Hide Channels Allows you to show or hide channels that appear in the Program Guide and when you use the CH+/- buttons to channel surf. Channels that are set to Hidden do not appear in the Program Guide or when you use the CH+/- buttons.

- 1 Press  or  to highlight the channel that you want to show or hide.
To move between the Major and Digital subchannel lists, press  or .
- 2 To change a channel’s setting to Shown or Hidden, press .
- 3 To show or hide more channels, repeat steps 1 and 2.

Option	Description
✎	If you select to hide or show a major digital channel, all the sub-channels are automatically hidden or shown. To show or hide an individual sub-channel within a digital channel, you must individually select that sub-channel to show or hide.
✎	If you hide all sub-channels of a major digital channel, that digital channel is automatically set to Hidden.

- Label Channels** Allows you to assign labels (such as station call letters) to channel numbers.
- 1** Press **▲** or **▼** to scroll through the channel numbers. Then press **⊕** to select the channel number that you want to assign a label.
 - 2** Press **▲** or **▼** to scroll through the label characters (A-Z, 0-9, etc.). Then press **⊕** to select the highlighted character. Repeat to add characters to the label.
 - 3** To assign labels to more channels, repeat steps 1-2.
 - 4** Press **◀** to return to the Channel settings, or press **WEGA GATE** to exit Settings.

Accessing the Parental Lock Settings

1. Press WEGA GATE..... 
2. Select Settings..... 
3. Highlight..... 
4. Press to select..... 

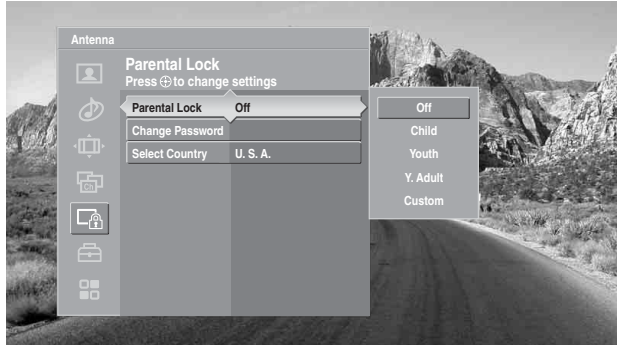

To highlight an option and to change settings, press



Press  to confirm the selection.

To exit Parental Lock, press .

The Parental Lock setting allows you to set up the TV to block programs according to their content and rating levels.

 **You need your password for any future access into the Parental Lock setting. If you lose your password, see “Lost password” on page 97.**

Selecting Parental Lock Options

 If you are not familiar with the Parental Guideline rating system, you should select Child, Youth, or Y.Adult to help simplify the rating selection. To set more restrictive ratings, select Custom.

The Parental Lock settings include the following options:

Option	Description
Parental Lock	Off Turn Parental Lock off. No programs are blocked from viewing.
<i>Turn ratings on/off and select a rating system</i>	Child Maximum ratings permitted are: U.S.: TV-Y, TV-G, G Canada: C, G, TV-Y
	Youth Maximum ratings permitted are: U.S.: TV-PG, PG Canada: C8+, PG, 8 ans+, TV-PG
	Y. Adult Maximum ratings permitted are: U.S.: TV-14, PG-13 Canada: 14+, 13 ans+, TV-14
	Custom Select to set ratings manually. U.S.: See page 83 for details. Canada: See page 84 for details.
Change Password	Select to change your password.
Select Country	U.S.A. Select to use U.S.A. ratings (see page 83). Canada Select to use Canadian ratings (see page 84).

To deactivate the parental control feature

- Set Parental Lock to Off when in the Parental Lock setting.

To change the password

- 1** In the Parental Lock setting, use the arrow buttons to highlight Change Password, and press (+) to select it.
- 2** Enter a new four-digit password using the 0-9 buttons.
- 3** Confirm the new password by entering it again.
- 4** Press WEGA GATE to exit Settings.

Viewing Blocked Programs

You can view a blocked program by entering the password.

- 1** Press ENT when tuned to a blocked program.
- 2** Enter your password using the 0-9 buttons.
Parental Lock will be canceled temporarily until you turn your TV off.

Selecting Custom Rating Options

 To ensure maximum blocking capability, the age-based ratings should be used.

US custom rating options

If you selected U.S.A. as the country of residence on page 82, the Custom Rating setting includes the following options. (If you selected Canada, see page 84.)

Option	Description
Movie Rating	G All children and general audiences.
	PG Parental guidance suggested.
	PG-13 Parental guidance for children under 13.
	R Restricted viewing, parental guidance is suggested for children under 17.
	NC-17 and X No one 17 and under.
TV Rating <i>Block programs by their rating, content or both</i>	Age-Based Options
	TV-Y All children.
	TV-Y7 Directed to children age 7 and older.
	TV-G General audience.
	TV-PG Parental guidance suggested.
	TV-14 Parents strongly cautioned.
	TV-MA Mature audience only.
	Content-Based Options
	FV Fantasy violence.
	D Suggestive dialog.
	L Strong language.
	S Sexual situations.
	V Violence.

(Continued)

Using the Settings

💡 If you select Block, be aware that the following programs may be blocked: news, sports, weather, emergency broadcasts, political programs, public service announcements, and religious programs.

Option	Description	
Unrated	Allow	Allows programs and movies that are broadcast without a rating.
<i>Block programs or movies that are broadcast without a rating</i>	Block	Blocks all programs and movies that are broadcast without a rating.

 **The content ratings will increase depending on the level of the age-based rating. For example, a program with a TV-PG V (Violence) rating may contain moderate violence, while a TV-14 V (Violence) rating may contain more intense violence.**

Canadian custom rating options

If you selected Canada as the country of residence on page 82, the Custom Rating setting includes the following options. (If you selected U.S.A., see page 83.)

Option	Description	
English Rating	C	All children.
	C8+	Children 8 years and older.
	G	General programming.
	PG	Parental guidance.
	14+	Viewers 14 and older.
18+	Adult programming.	
French Rating	G	General programming.
	8 ans+	Not recommended for ages under 8.
	13 ans+	Not recommended for ages under 13.
	16 ans+	Not recommended for ages under 16.
18 ans+	Programming restricted to adults.	
U.S.A. Rating	See “TV Rating” on page 83 for details.	

Accessing the Setup Settings

1. Press WEGA GATE.....



2. Select Settings.....



3. Highlight.....



4. Press to select.....



To highlight an option and to change settings, press
 ▲ ▼ ◀ ▶.

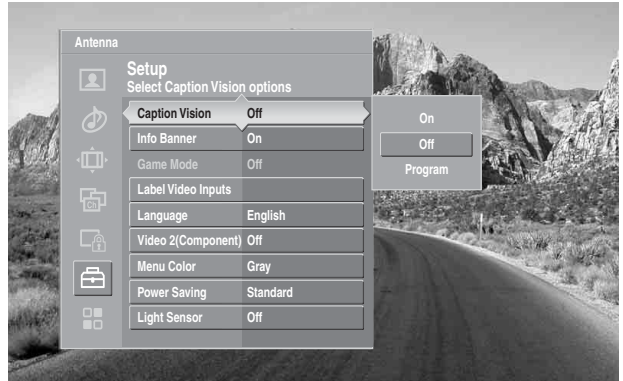

Press  to confirm the selection.

To exit Setup, press .



Selecting Setup Options

The Setup settings includes the following options:

Option	Description
Caption Vision	Allows you to select from several closed caption modes (for programs that are broadcast with closed caption). On Caption Vision is turned on. Off Caption Vision is turned off. Program Allows you to set basic and advanced Caption Vision options. See “Programming Caption Vision” on page 87.
Info Banner	Set to On or Off. Select On to display the program name, time remaining and other information (if the broadcaster offers this service). Also displays when the channel is changed or the DISPLAY button is pressed.
Game Mode	On Select to optimize the lipsync when playing games. Off Select to turn off the Game Mode.
Label Video Inputs	Allows you to label the audio/video equipment you have connected to the TV so you can identify them when using TV/VIDEO. When in this setting: 1 Press ▲ or ▼ to highlight an input to label, then press  to select it. 2 Use the arrow buttons to scroll through the labels. 3 Press  to select the equipment you connected to each of the input jacks on the back of your TV. Select Skip if you do not have any equipment connected to a particular input.

 If you have assigned video labels, you can see the External Inputs list on the WEGA GATE control panel.





(Continued)

Using the Settings

 The Skip label is useful for inputs to which no equipment is connected.

 If you use the composite connection when Video 2 (Component) is set to Auto, do not connect the component cable at the same time. Otherwise select Off.

 To change from one Power Saving option to another, use POWER SAVING on the remote control.

Option	Description
Video 1-6	Video 1-6, VHS, DVD, Receiver, Satellite, Cable Box, 8mm, DTV, Game, LD, Beta, HD, DVR, Camcorder, Skip
Video 7	Video 7, PC, DVD, HD, Game, Skip
 If you select Skip, your TV skips this input when you press the TV/VIDEO button.	
Language	Select to display all on-screen settings in your language of choice: English, Español, Français.
Video 2 (Component)	<p>Auto Select to switch automatically between the component video jacks (Y PB/CB PR/CR, AUDIO L (MONO)/AUDIO R) and the composite video jacks (VIDEO, AUDIO L (MONO)/AUDIO R) on the left side of the TV (VIDEO/HD/DVD 2 IN) depending on the cable connection.</p> <p>Off Select to activate the composite video jacks (VIDEO/AUDIO L(MONO)/AUDIO R) on the left side of the TV.</p>
Menu Color	Enables you to select a specific color for the on-screen settings.  Not available when using the Photo/Video Viewer.
Power Saving	<p>Standard Select to view picture without the benefit of Power Saving.</p> <p>Reduced Select to view picture with reduced power consumption. It also enhances the black level.</p> <p>Picture Off Select to turn off the picture. Audio stays on with your selected volume setting.</p> <p> Picture Off is not available when using the Photo/Video Viewer.</p>
Light Sensor	Select On to enable the automatic brightness control. The light sensor measures the room brightness which allows the TV to automatically adjust the picture brightness based on the picture settings and the ambient room light conditions.  Be sure not to put anything around the sensor, as its function may be affected. See page 15 on the sensor.
CineMotion	Select Auto to optimize the screen display automatically detecting film content and applying a reverse 3-2 pull down process. Moving picture will appear clearer and more natural looking. Select Off to disable the detection.

Programming Caption Vision

If you selected the Program option under Caption Vision (see page 85), you can change the following settings:

<i>Option</i>	<i>Description</i>																					
Basic	Allows you to select basic analog (EIA-608) closed caption options.																					
	CC1, CC2, CC3, CC4 Displays a printed version of the dialog or sound effects of a program. (Should be set to CC1 for most programs.)																					
	Text1, Text2, Text3, Text4 Displays network/station information presented using either half or the whole screen (if available).																					
Digital CC	Allows you to set digital closed captioning to Basic (digital EIA-608) or Advanced (digital EIA-708).																					
Advanced	Allows you to select advanced digital (EIA-708) closed caption options. Select from the available options.																					
Advanced Settings	Allows you to make additional settings for digital (EIA-708) closed caption options. Select from As Broadcast , Small Text , Large Text and Custom .																					
	<table border="1"> <thead> <tr> <th>Custom</th> <th>Allows you to customize the following settings:</th> </tr> </thead> <tbody> <tr> <td>Character Size</td> <td>Small, Standard, Large</td> </tr> <tr> <td>Character Style</td> <td>Style 1-7</td> </tr> <tr> <td>Character Color</td> <td>Color 1-8</td> </tr> <tr> <td>Character Opacity</td> <td>Solid, Translucent</td> </tr> <tr> <td>Edge Color</td> <td>Color 1-8</td> </tr> <tr> <td>Edge Type</td> <td>None, Raised, Depressed, Outline, Left Shadow, Right Shadow</td> </tr> <tr> <td>Background Color</td> <td>None, Color 1-8</td> </tr> <tr> <td>Background Opacity</td> <td>Solid, Translucent</td> </tr> <tr> <td>Window Color</td> <td>None, Color 1-8</td> </tr> <tr> <td>Window Opacity</td> <td>Solid, Translucent</td> </tr> </tbody> </table>	Custom	Allows you to customize the following settings:	Character Size	Small, Standard, Large	Character Style	Style 1-7	Character Color	Color 1-8	Character Opacity	Solid, Translucent	Edge Color	Color 1-8	Edge Type	None, Raised, Depressed, Outline, Left Shadow, Right Shadow	Background Color	None, Color 1-8	Background Opacity	Solid, Translucent	Window Color	None, Color 1-8	Window Opacity
Custom	Allows you to customize the following settings:																					
Character Size	Small, Standard, Large																					
Character Style	Style 1-7																					
Character Color	Color 1-8																					
Character Opacity	Solid, Translucent																					
Edge Color	Color 1-8																					
Edge Type	None, Raised, Depressed, Outline, Left Shadow, Right Shadow																					
Background Color	None, Color 1-8																					
Background Opacity	Solid, Translucent																					
Window Color	None, Color 1-8																					
Window Opacity	Solid, Translucent																					

Selecting PC Setup Options

To display the PC screen:

Press TV/VIDEO repeatedly on the remote control until Video 7 (PC) appears.

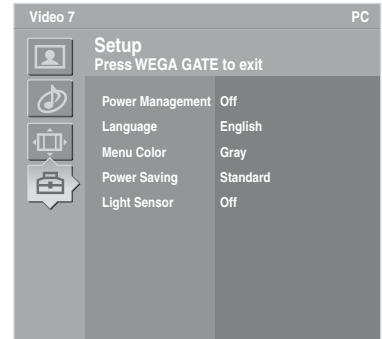

 You can change the settings for the PC input while the TV is displaying the PC screen.



The PC Input Setup setting includes the following options:

Option	Description
Power Management	On Select to automatically switch to the standby mode when there is no signal input for approximately 30 seconds. Returns to the PC screen when a signal is input.
	Off Select to turn off Power Management.
Language	Select to display all on-screen Settings in your language of choice: English, Español, Français.
Menu Color	Enables you to select a specific color for the on-screen menus from Original, Gray, Red, Purple and Tan.
Power Saving	Standard Select to view picture without the benefit of Power Saving.
	Reduced Select to view picture with reduced power consumption. It also enhances the black level.
	Picture Off Select to turn off the picture. Audio stays on with your selected volume setting.
Light Sensor	Set to On or Off. When on, the brightness of the screen is automatically adjusted according to the brightness of the room.
<p> Be sure not to put anything around the sensor, as its function may be affected. For details, see page 15.</p>	





PC Input Signal Reference Chart

Resolution Signals	Horizontal (Dot)	×	Vertical (Line)	Horizontal frequency (kHz)	Vertical frequency (Hz)	VESA standard
VGA	640	×	480	31.5	60	—*
	640	×	480	37.5	75	✓
	640	×	480	43.3	85	✓
	720	×	400	31.5	70	—*
SVGA	800	×	600	35.2	56	✓
	800	×	600	37.9	60	✓
	800	×	600	46.9	75	✓
	800	×	600	48.1	72	✓
XGA	1024	×	768	48.4	60	✓
	1024	×	768	56.5	70	✓
	1024	×	768	60	75	✓
WXGA	1280	×	768	47.4	60	✓
	1280	×	768	47.8	60	✓
	1360	×	768	47.7	60	✓

*: Corresponding to the VGA signal

-  This TV's PC input does not support Sync on Green or Composite Sync.
-  This TV's PC input does not support interlaced signals.
-  This TV's PC input supports signals in the above chart with a 60Hz vertical frequency.
For other signals, you will see the message "Unsupported Signal".
For the best picture quality, it is recommended to use signals with a 60Hz vertical frequency from a personal computer.

Accessing the Applications Settings

1. Press WEGA GATE..... 
2. Select Settings..... 
3. Highlight..... 
4. Press to select..... 

To highlight an option and to change settings, press **↑ ↓ ← →**.

Press **⊕** to confirm the selection.

To exit Applications, press **WEGA GATE**.

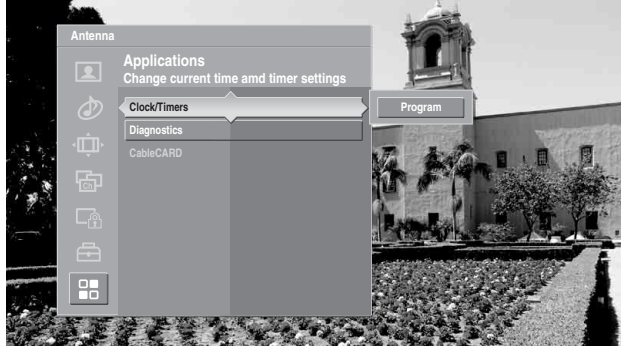

Selecting Applications Options

The Applications settings includes the following options:

Option	Description
Clock/Timers	Select to set the clock and to program your TV to turn on and off at two scheduled viewing times. Once the options are set, TIMER LED lights up in red.
Sleep	Allows you to select the amount of time (Off, 15 minutes, 30 minutes, 45 minutes, 60 minutes or 90 minutes) that you want the TV to remain on before shutting off automatically.
Timer 1 Timer 2	You can use the Timers to program the TV to turn on and off and tune to a specific channel at two scheduled viewing times.
Timer 1 and Timer 2 cannot be set until you set the Current Time.	
<ol style="list-style-type: none"> 1 Press ↑ or ↓ to highlight Timer 1 or Timer 2. To set the timer, press → or ⊕. 	
<p> To go directly to programming Timer 1 or 2, press ⊕ instead of pressing →.</p> <ol style="list-style-type: none"> 2 Press ↑ or ↓ to highlight one of the following options, then press ⊕. 	
Program	Select to set the Timer by day, time, duration, and channel.
Off	Select to turn off the Timer. (Your previous settings are saved.)

 To return to the Timer settings after programming one of the Timers or current time, press **←**.

 Timer will be set to Off when:

- Auto Program is executed
- the AC power cord is disconnected and then reconnected to turn the TV on and the Current Time is displayed as 12:00 AM.

Option	Description
	<p>3 If you selected Program in step 2, press ▲ and ▼ to set the day(s), hour, minute, AM/PM, duration, and channel number. Press ⊕ or ▶ to confirm each setting and move to the next setting. Press ◀ to go back to the previous setting.</p> <p>4 Press WEGA GATE to exit Settings. An LED on the front panel will light, indicating the Timer has been set.</p>
<p>Current Time</p>	<p>Select to set the current time (day, hour, minute, and AM/PM).</p> <p>Program Select to set the Timer by day, time, and AM/PM.</p> <p>Off Select to turn off the Timer. (Your previous settings are saved.)</p> <p>1 Press ⊕ to select Current Time.</p> <p>2 Press ▲ and ▼ to set the current time (day, hour, minute, and AM/PM). Press ⊕ or ▶ to confirm each setting and move to the next setting. Press ◀ to go back to the previous setting.</p> <p>3 Press WEGA GATE to exit Settings.</p>
<p>Diagnostics</p>	<p>Display diagnostics information about the TV. This can be useful in providing information to an authorized technician or repair person.</p>
<p>CableCARD</p>	<p>This list of selectable CableCARD options will vary, depending on your cable service provider.</p>

Other Information

Overview

This chapter includes the following topics:

Topic	See Page
Contacting Sony	92
Troubleshooting	92
Specifications	98
Optional accessories	98
Index	99

Contacting Sony

If, after reading these operating instructions, you have additional questions related to the use of your Sony television, please call our Customer Information Services Center.

For US residents: 1-800-222-SONY (7669)

For Canadian residents: 1-877-899-SONY (7669)

Before calling Sony customer support, please write down the model and serial numbers of your TV.

Troubleshooting

Remote Control

Problem	Possible Remedies
Remote control does not operate	<ul style="list-style-type: none"><input type="checkbox"/> The batteries could be weak. Replace the batteries.<input type="checkbox"/> Check the orientation of the batteries.<input type="checkbox"/> Press TV (FUNCTION) once, and the TV indicator lights up. You may have inadvertently pressed SAT/CABLE (FUNCTION), which changes the remote control to SAT or CABLE mode.<input type="checkbox"/> Make sure this unit's power cord is connected securely to the wall outlet.
Cannot change channels with the remote control	<ul style="list-style-type: none"><input type="checkbox"/> If you are using the TV to change channels, first press TV (FUNCTION) once, and the TV indicator lights up.<input type="checkbox"/> If you are using another device to change channels, be sure you have not inadvertently switched your TV from the channel 3 or 4 setting.<input type="checkbox"/> If you are using another device to change channels, be sure to press FUNCTION for that device. For example, if you are using your cable box to change channels, be sure to press SAT/CABLE (FUNCTION) once, and the SAT/CABLE indicator lights up.

Problem	Possible Remedies
Remote control does not operate non-Sony video equipment	<ul style="list-style-type: none"> <input type="checkbox"/> If you replaced the batteries to the remote recently, the code numbers for the video equipment may need to be reset. <input type="checkbox"/> There may be more than one code for the equipment that you are attempting to operate. <input type="checkbox"/> There is a possibility that some non-Sony equipment cannot be operated by your Sony TV remote. You may need to use the equipment's original remote control.

CableCARD Device

Problem	Possible Remedies
Problems using CableCARD device or CableCARD services	<ul style="list-style-type: none"> <input type="checkbox"/> Check that the CableCARD device is inserted properly (see pages 29-30). <input type="checkbox"/> The CableCARD device must be activated by your local cable TV provider before you can receive digital cable TV services. See the activation instructions on pages 29-30. <input type="checkbox"/> Check the Diagnostics and CableCARD setting options (see page 91). (This can be useful in providing information to an authorized technician or repair person.) <input type="checkbox"/> Contact your cable TV provider.

Video

Problem	Possible Remedies
No picture (screen not lit), no sound	<ul style="list-style-type: none"> <input type="checkbox"/> If your TV does not turn on and a red light keeps flashing, your TV may need service. Call your local Sony Service Center. <input type="checkbox"/> Make sure the power cord is plugged in. <input type="checkbox"/> Press POWER on the right side of the TV. <input type="checkbox"/> Press TV/VIDEO to cycle through the connected video sources. <input type="checkbox"/> Try another channel; it could be station trouble.
Dark, poor or no picture (screen lit), good sound	<ul style="list-style-type: none"> <input type="checkbox"/> Adjust the Picture Mode option in the Video setting (see page 71). <input type="checkbox"/> Adjust the Brightness option in the Video setting (see page 71). <input type="checkbox"/> Check the antenna/cable connections.
No color/dark picture/color is not correct	<ul style="list-style-type: none"> <input type="checkbox"/> Adjust the Color option in the Video setting (see page 71).
Only snow and noise appear on the screen	<ul style="list-style-type: none"> <input type="checkbox"/> Check the antenna/cable connections. <input type="checkbox"/> Try another channel; it could be station trouble. <input type="checkbox"/> Press ANT to change the input mode (see page 42).
Dotted lines or stripes	<ul style="list-style-type: none"> <input type="checkbox"/> Adjust the antenna. <input type="checkbox"/> Move the TV away from noise sources such as cars, neon signs, or hair dryers.
Double images	<ul style="list-style-type: none"> <input type="checkbox"/> Using a highly directional outdoor antenna or a cable may solve the problem.
"Black box" on screen	<ul style="list-style-type: none"> <input type="checkbox"/> You have selected a text option in the Setup setting and no text is available. (See page 85 to reset Setup selections.) To turn off this feature, set the Caption Vision option to Off. If you were trying to select closed captioning, select CC1 instead of Text1-4.

(Continued)

Other Information

Problem	Possible Remedies
Black bands appear at the top and bottom of the screen	<input type="checkbox"/> Some wide-screen programs are filmed in aspect ratios that are greater than 16:9 (this is especially common with theatrical releases). Your TV will show these programs with black bands at the top and bottom of the screen. For more details, check the documentation that came with your DVD (or contact your program provider).
Certain programs on DVD or other digital sources display a loss of detail, especially during fast-motion or dark scenes	<input type="checkbox"/> The compression used by certain digital broadcasts and DVDs may cause your TV's screen to display less detail than usual, or cause artifacts (small blocks or dots, pixelations) to appear on your screen. This is due to your TV's large screen and ability to show very fine detail, and is normal for certain digitally recorded programs. Adjust the reality/clarity in the DRC Palette setting (see page 72) to optimize the picture while viewing these sources.

Audio

Problem	Possible Remedies
Good picture, no sound	<input type="checkbox"/> Press MUTING so that Muting disappears from the screen (see page 42). <input type="checkbox"/> Make sure the Speaker option is set to On in the Audio setting (see page 75). <input type="checkbox"/> Make sure the MTS option is set to Stereo or Mono (see page 75). <input type="checkbox"/> When the HDMI IN input is in use, surround sound, such as AC-3 and DTS , cannot be input. Change the sound setting for the external input device to Linear PCM .
Audio noise	<input type="checkbox"/> Communication problems may occur if infrared communication equipment (e.g., infrared cordless headphones) is used near the TV. Use headphones other than infrared cordless headphones. Also, if you use infrared communication equipment other than infrared cordless headphones, move the infrared transceiver away from the TV until the noise is eliminated, or move the transmitter and receiver of the infrared communication equipment closer together.
Cannot gain enough volume when using a cable box	<input type="checkbox"/> Increase the volume of the cable box using the cable box's remote control. Then press TV (FUNCTION) once (the TV indicator lights up) and adjust the TV's volume.
Sound seems weak or insufficient	<input type="checkbox"/> The TV's audio might be set to Auto SAP or Mono , when it might be better set to Stereo . In the Audio setting (see page 75), set the MTS setting to Stereo . If already set to Stereo , switch to Mono (which may reduce background noise during weak stereo broadcasts).
Cannot raise the volume on external speakers	<input type="checkbox"/> If the Speaker option is set to Off and the Audio Out option is set to Fixed (in order to output the sound to your audio system), use your audio receiver to adjust the sound (see page 75). Or, to use the TV remote control, set the Audio Out option to Variable . <input type="checkbox"/> To turn on the TV speakers, set the Speaker option to On (see page 75).

Channels

Problem	Possible Remedies
Cannot receive upper channels (UHF) when using an antenna	<ul style="list-style-type: none"> <input type="checkbox"/> Press ANT to select the VHF/UHF input (see page 42). <input type="checkbox"/> Use Auto Program in the Channel setting to add receivable channels that are not presently in the TV's memory (see page 80).
Cannot receive any channels when using cable TV	<ul style="list-style-type: none"> <input type="checkbox"/> Use Auto Program in the Channel setting to add receivable channels that are not presently in the TV's memory (see page 80). <input type="checkbox"/> Press ANT to select the CABLE input (see page 42).
Cannot receive or select channels	<ul style="list-style-type: none"> <input type="checkbox"/> Use Auto Program in the Channel setting to add receivable channels that are not presently in TV memory (see page 80).
Some digital cable channels are not being displayed	<ul style="list-style-type: none"> <input type="checkbox"/> Certain cable companies have limitations on the broadcast of digital cable channels. Check with your cable company for more information. <input type="checkbox"/> The digital cable channel may be set to Hidden in the Channel setting (see page 80).





USB

Problem	Possible Remedies
USB device does not work	<ul style="list-style-type: none"> <input type="checkbox"/> Check the USB device connection. Most Sony digital still cameras and camcorders in the market at the time of sale of this product are supported but some may not work correctly. <input type="checkbox"/> Cameras from other manufacturers, non-camera USB devices (printers, USB readers, etc.) may not work correctly.
Cannot see files in Photo/Video Viewer	<ul style="list-style-type: none"> <input type="checkbox"/> Check Filter and Select Folder settings (see page 67). <input type="checkbox"/> The maximum number of files the Photo/Video Viewer can display is 2,000 files in total, including all JPEG, MPEG1, and MP3 files.
Cannot edit the files	<ul style="list-style-type: none"> <input type="checkbox"/> If your digital still camera has an internal memory, you can view the files in the internal memory but cannot edit them. To edit the files, make a copy to a media such as Memory Stick in your digital still camera.
Image does not display	<ul style="list-style-type: none"> <input type="checkbox"/> Some variations of MPEG1 movies may not play back correctly. <input type="checkbox"/> Make sure the image file is a JPEG (.jpg, .jpeg) file or an MPEG1 (.mpg, .mpeg) file.
JPEG image displays undesirable motion or flicker in full screen	<ul style="list-style-type: none"> <input type="checkbox"/> JPEGs captured using a digital video camera may appear to display motion in full screen. This is a result of the way digital video cameras record still images, and is not a result of a malfunction with the TV.

(Continued)

Other Information

Problem	Possible Remedies
MPEG movie playback is choppy and progress bar is not accurate or MPEG1 movie does not play back correctly	<input type="checkbox"/> High bit-rate MPEG movies, such as those recorded in high frame rates or high resolution (such as VX Fine mode), may not play back correctly. To view such movies, connect a camera or camcorder that supports USB 2.0 connection and Memory Stick PRO media.
Rotation not saved after USB device is disconnected or Photo/Video Viewer is closed	<input type="checkbox"/> The file might not have information (EXIF data) that is usually generated when a digital camera records a photo. In this case, it is not possible to save the rotation. <input type="checkbox"/> There might be insufficient space on the USB media to save the rotated file. Try deleting one or more files and rotating the image again.
Cannot show (or hide) file information in full screen or Slide Show	<input type="checkbox"/> Set the File Information option to On or Off (see page 66). <input type="checkbox"/> After selecting the file, press the DISPLAY button on the remote control. The file information will be displayed on the top of the TV screen.
Cannot see menu	<input type="checkbox"/> Press ▲ to display the menu again.
Cannot hear audio while using USB device	<input type="checkbox"/> Check the TV's volume or Speaker (see page 75) settings. <input type="checkbox"/> Check that the Music option is not set to Off (see page 66).
Not all MP3 files on USB media are included when the Music/Complete List option is selected (page 66)	<input type="checkbox"/> The Photo/Video Viewer can display a maximum of 2,000 files in total, including all JPEG, MPEG1, and MP3 files. <input type="checkbox"/> Make sure that the file is named with the file extension (.mp3).
MP3 files on the USB media are not listed	<input type="checkbox"/> Only MP3 files that are named with the file extension (.mp3) are displayed in the list.
Music files are playing in wrong order	<input type="checkbox"/> MP3 files are played in alphabetical order, according to the folder in which they are stored. If you want to change the playlist order, rename your files alphabetically in the order in which you want them to play or create a MP3 playlist (.m3u file) on a PC.
Cannot see MP3 list to play music	<input type="checkbox"/> MP3 files on your USB media only can be played as background music during a Slide Show (page 66).
MPEG1 quality is poor when enlarged (page 64)	<input type="checkbox"/> The quality of the movie when played back on the TV depends on the resolution the movie was shot in, and the connection speed between the USB device and TV (see above). See your camera's instruction manual for details.
"No USB device or Media" error message is displayed	<input type="checkbox"/> Check the USB device is connected properly. <input type="checkbox"/> Check the USB device power is turned on. <input type="checkbox"/> Not all USB devices are supported (see page 57).

Problem	Possible Remedies
Error icon is displayed	 The file is not a valid MPEG1 or JPEG format, or it is a progressive JPEG (which is not supported).
	 The thumbnail is not DCF-compatible.
	 The file is a JPEG or an MPEG1, but the thumbnail is unreadable.
	 The file is unreadable.

General

Problem	Possible Remedies
How to reset the TV to factory settings	<input type="checkbox"/> Turn on the TV. While holding down the ▲ button on the remote control, press the POWER button on the TV. (The TV will turn itself off, then back on again.) Release the ▲ button. WARNING: The Reset will clear all of your customized settings including Parental Lock setting.
How to restore Video settings to factory settings	<input type="checkbox"/> Select Reset setting option while in the Video setting (see page 71).
How to restore Audio settings to factory settings	<input type="checkbox"/> Select Reset setting option while in the Audio setting (see page 74).
Cannot cycle through the other video equipment connected to the TV	<input type="checkbox"/> Be sure the Label Video Inputs option is not set to Skip (see page 85).
Cannot operate the setting	<input type="checkbox"/> If a setting option appears in gray, this indicates that the setting option is not available.
Lost password	<input type="checkbox"/> On the password screen (see page 82), enter the following master password: 4357 . The master password clears your previous password; it cannot be used to temporarily unblock channels.
TIMER LED on front panel is lit	<input type="checkbox"/> When lit, indicates that the timer is set (see page 90). When the timer is set, this LED will remain lit even when the TV is turned off.
Digital cable box does not work	<input type="checkbox"/> If you are connecting a VCR and digital cable box using a splitter, as described on page 34, you must use a special bi-directional splitter that is designed to work with your digital cable box. Contact your cable provider for details.
Cannot record digital channels to VCR	<input type="checkbox"/> Only analog channels can be recorded to your VCR.
TV cabinet creaks	<input type="checkbox"/> When the TV is in use, there is a natural rise in temperature, causing the cabinet to expand or contract and may be accompanied by a slight creaking noise. This is not a malfunction.

Specifications

Television system:

American TV standard

Channel coverage:

VHF: 2-13/UHF: 14-69/CATV: 1-125

Antenna:

75-ohm external terminal for VHF/UHF

Screen size (measured diagonally):

KDL-V26XBR1: 26 inches

KDL-V32XBR1: 32 inches

KDL-V40XBR1: 40 inches

Panel System:

LCD (Liquid Crystal Display) Panel

Display resolution (horizontal × vertical):

1,366 pixels × 768 lines

VIDEO IN 1/2/3:

S VIDEO (4-pin mini DIN):

Y: 1.0 Vp-p, 75 ohms unbalanced, sync negative

C: 0.286 Vp-p (Burst signal), 75 ohms

VIDEO: 1 Vp-p, 75 ohms unbalanced, sync negative

AUDIO: 500 mVrms (100% modulation)

Impedance: 47 kilohms

HD/DVD IN 4/5:

Y Pb/Cb Pr/Cr (Component Video):

Y: 1.0 Vp-p, 75 ohms unbalanced, sync negative

Pb/Cb: 0.7 Vp-p, 75 ohms

Pr/Cr: 0.7 Vp-p, 75 ohms

Signal format: 480i, 480p, 720p, 1080i

AUDIO: 500 mVrms (100% modulation)

Impedance: 47 kilohms

HDMI IN 6:

HDMI: Video: 480i, 480p, 720p, 1080i

Audio: Two channel linear PCM 32, 44.1 and 48 kHz, 16, 20 and 24 bits

AUDIO: 500 mVrms (100% modulation)

Impedance: 47 kilohms

AUDIO OUT:

500 mVrms (100% modulation)

More than 1 Vrms at the maximum volume setting (Variable)

More than 500 mVrms (Fixed)

PC IN 7:

D-sub 15-pin, analog RGB, 0.7 Vp-p, 75 ohms, positive

See the PC Input Signal Reference Chart on page 89.

PC AUDIO INPUT:

Stereo mini jack, 0.5 Vrms, 1 kilohm

Headphones:

Stereo mini jack Impedance: 16 ohms

Speaker:

Woofer: 4.0 × 10 cm (4 inches) (2)

Tweeter: φ 4.0 cm (1 5/8 inches) (2)

Speaker output:

13 W + 13 W

Power requirement:

120-240 V AC, 50/60 Hz

Power consumption:

In use: KDL-V26XBR1: 140 W

KDL-V32XBR1: 166 W

KDL-V40XBR1: 240 W

In standby: KDL-V26XBR1: Less than 0.15 W

KDL-V32XBR1: Less than 0.15 W

KDL-V40XBR1: Less than 0.15 W

Dimensions (W/H/D):

KDL-V26XBR1: (with stand) 674.8 × 511.5 × 308.2 mm

(26 5/8 × 20 1/4 × 12 1/4 inches)

(without stand) 674.8 × 472.7 × 103 mm

(26 5/8 × 18 5/8 × 4 1/8 inches)

KDL-V32XBR1: (with stand) 808 × 587.8 × 308.2 mm

(31 7/8 × 23 1/4 × 12 1/4 inches)

(without stand) 808 × 549.4 × 110.5 mm

(31 7/8 × 21 3/4 × 4 3/8 inches)

KDL-V40XBR1: (with stand) 1014.4 × 722.7 × 370.3 mm

(40 × 28 1/2 × 14 5/8 inches)

(without stand) 1014.4 × 683.3 × 121.3 mm

(40 × 27 × 4 7/8 inches)

Mass:

KDL-V26XBR1: (with stand) 18.5 kg (40 lb. 13 oz.)

(without stand) 14.5 kg (32 lb.)

KDL-V32XBR1: (with stand) 23.7 kg (52 lb. 4 oz.)

(without stand) 19.7 kg (43 lb. 7 oz.)

KDL-V40XBR1: (with stand) 34.3 kg (75 lb. 10 oz.)

(without stand) 28.1 kg (62 lb.)

Supplied accessories:

Remote control RM-YD002 (1)

Size AA batteries (2)

AC power cord (1)

HD15-HD15 cable (ferrite core attached) (1)

Support belt (1), securing screw (1) and wood screw (1)

Cable holder (1)

Coaxial cable (1)

PC Audio cable holder (1)

Operating Instructions (1)

Quick Setup Guide (1)

Product Registration Card (1)

Warranty Card (1)

Optional accessories:

HDMI cable

HDMI-to-DVI cable

Component video cable

S VIDEO cable

A/V cable

Audio cable

Optical cable

Wall-Mount Bracket: SU-WL31(KDL-V26XBR1/KDL-V32XBR1)

SU-PW2 (KDL-V40XBR1)



The availability of optional accessories depends on stock.

Design and specifications are subject to change without notice.

Index

- 0-9 buttons 42
- 4:3 Default 78
- 5.1 Channel DVD using with remote control 47

A

- A/V Sync 75
- About USB 57, 68
- AC IN 18
- Advanced Settings, Caption Vision 87
- Advanced Video 73
- Advanced, Caption Vision 87
- Alternate Audio 49
- Alternate Video 49
- ANT button 42
- Antenna, WEGA GATE 53, 55
- Applications settings 70, 90
- Audio Out 75
- AUDIO OUT jack, described 18
- Audio Out, PC Input 76
- Audio receiver, connecting 40
- Audio setting 69, 74
- Auto Adjustment, PC Input 79
- Auto Program 80

B

- Backlight, adjusting 71
- Backlight, PC Input 73
- Balance, adjusting 74
- Balance, PC Input 76
- Basic, Caption Vision 87
- Bass, adjusting 74
- Bass, PC Input 76
- Batteries, inserting in remote 41
- BBE 74
- Brightness, adjusting 71
- Brightness, PC Input 73

C

- Cable
 - connecting with VCR 33
 - using with remote control 46
- Cable box
 - connecting with VCR 34
 - using with remote control 46
- CABLE jack, described 18

- Cable, WEGA GATE 53, 55
- CableCARD 91
- CableCARD device 29
- CableCARD slot 18
- Camcorder, connecting 40
- Caption Vision 85, 87
- CH +/- 43
- Change Password 82
- CHANNEL buttons 16
- Channel setting 70, 80
- CineMotion 86
- Clock/Timers 90
- Color Temp. 72
- Color Temp., PC Input 73
- Color, adjusting 71
- Connecting
 - Audio receiver 40
 - Cable box 22–23
 - Camcorder 40
 - DVD player 37–38
 - Personal Computer 39
 - Satellite receiver 24
 - VCR 33–36

D

- Delete 62, 65
- Diagnostics 91
- Digital CC, Caption Vision 87
- Digital Channels 80
- Digital subchannels 49
- Digital Visual Interface (DVI) 19
- Display Area 78
- DISPLAY button 43
- Display Mode, PC Input 73
- DRC Mode 72
- DRC Palette 72
- DVD player
 - using with remote control 46
 - with A/V connectors, connecting 38
 - with component video connectors, connecting 37
- DVD/VCR Operating Buttons 42
- DVD/VCR Record Buttons 43

E

- Effect 74
- Effect, PC Input 76

- English Rating 84
- ENT button 16, 42
- Error messages, USB 96
- External Inputs, WEGA GATE 53, 56

F

- F1/F2 button 43
- Favorite Channels 80
- Favorites, WEGA GATE 53, 54
- Features 11
- File 62, 65
- File Information 66
- File Order 67
- Filter 67
- Freeze 51
- FREEZE button 43, 51
- French Rating 84
- FUNCTION buttons 42

G

- Game Mode 85
- Game Picture 77
- GUIDE button 42, 48
- Guide, settings 48

H

- HD/DVD IN jack (1080i/720p/480p/480i), described 18
- HDMI IN jack, described 18
- Headphones jack, described 16
- High-Definition Multimedia Interface (HDMI) 19
- Horizontal Center 79
- Hue, adjusting 71

I

- Index 62, 65
- Info Banner 85
- Infrared Receiver (IR) 15

J, K

- JPEG 57
- JUMP 51
- JUMP button 42, 51

(Continued)

L

Label Channels 81
Label Video Inputs 85
Language 86
Language, PC Input 88
Light Sensor
described 15
setting 86, 88

M

MENU button 43, 46
Menu Color 86
Menu Color, PC Input 88
Movie Rating 83
MPEG 57
MTS 75
MTS/SAP button 43
Music 66
MUTING button 42

N

Noise Reduction 72

O

OPTICAL OUT, described 18

P, Q

Parental Lock setting 70, 82
Password, changing 83
PC IN 18
Personal Computer
connecting 39
Phase, PC Input 79
Photo, WEGA GATE 53, 56, 61
Photo/Video Viewer
Index 59
index options 66
movie options 65
panning photos 63
photo options 62
playing movies 64
rotating photos 63
slide show options 66
viewing photos 61
zooming photos 63
PIC OFF LED 15
PICTURE button 42
Picture Mode, selecting 71
Picture, adjusting 71
Picture, PC Input 73
Pitch, PC Input 79
POWER (GREEN) button 43
POWER button 16
Power Management, PC Input 88
Power Saving 51, 86

POWER SAVING button 43, 51
Power Saving, PC Input 88
POWER/STANDBY LED 15
Print Quantity 62
Problems, Troubleshooting 92–97
Program Guide 48
Program Options 49
Protect 62, 65

R

Ratings
setting 83
viewing blocked programs 83
Remote control
inserting batteries 41
programming 44–45
Repeat 66
Reset, audio settings 74
Reset, video settings 71
RETURN button 42
Rotate 62

S

S VIDEO jack, described 18, 20
Satellite receiver
connecting 24
using with remote control 46
Screen setting 69, 77
Select Country 82
Select Folder 67
Settings
Applications 70, 90
Audio 69, 74
Channel 70, 80
Parental Lock 70, 82
Screen 69, 77
Setup 70, 85
Video 69, 71
Settings, WEGA GATE 53, 56
Setup setting 70, 85
Sharpness, adjusting 72
Show/Hide Channels 80
Slide Advance 66
Slide Show 62, 65
SOUND button 42
Sound Mode, PC Input 76
Sound Mode, selecting 74
Speaker
described 15
selecting 75
Speaker, PC Input 76
Start 66
Steady Sound 74
Support Belt 13
SUR button 43

Swivel 14

T, U

Tilt 14
TIMER LED 15
Timer, setting 90
TOOLS button 43
TOP MENU button 43, 46
Transition Effect 66
Treble, adjusting 74
Treble, PC Input 76
Troubleshooting 92–97
Turning on/off the TV 16
TV POWER button 43
TV Rating 83
TV/SAT button 43
TV/VIDEO button 16, 42
U.S.A. Rating 84
Unrated 84
USB jack, described 16
USB Media 67

V

VCR
using with remote control 46
with cable box, connecting 34
with cable, connecting 33
Vertical Center 78, 79
Vertical Size 78
VHF/UHF jack, described 18
Video 2 (Component) 86
Video setting 69, 71
Video, WEGA GATE 53, 56, 64
VIDEO/AUDIO (L/R) jacks,
described 18
VIDEO/HD/DVD jacks, described
16
View 62
VISUAL SEARCH button 42
VOL +/- button 42
VOLUME buttons 16
Volume Offset 74

W, X, Y

WEGA GATE 52
WEGA GATE button 16, 43
WIDE button 43, 50
Wide Mode 77
Wide Mode, PC Input 79
Wide Screen Mode 50

Z

Zoom/Pan 62



S-master
Digital Amplifier **HDMI**



<http://www.sony.net/>



2662199111

Printed in U.S.A.