

SKYBOX CHROMA™



intelion
INTELLIGENT
LITHIUM-ION
BATTERY SYSTEM



Blizzard Lighting, LLC
www.blizzardlighting.com
Waukesha, WI USA
Copyright (c) 2016

TABLE OF CONTENTS

SkyBox™ Chroma	1
1. Getting Started	4
What's In The Box?	4
Getting It Out Of The Box	4
Powering Up!	4
Getting A Hold Of Us	4
Safety Instructions (Don't run with scissors!)	5
2. Meet The SkyBox™ Chroma	6
Features	6
DMX Quick Reference	6
The SkyBox™ Chroma Pin-up Picture	7
3. Setup	8
Connecting A Bunch Of SkyBox™ Chroma Fixtures	8
Data/DMX Cables	8
Using Skywire™ Wireless DMX	8
Using The Intelion™ Battery System	9
Cable Connectors	10
3-Pin??? 5-Pin??? Huh?	10
Take It To The Next Level: Setting up DMX Control	10
Fixture Linking (Master/Slave Mode)	11
Mounting/Rigging	11
4. Operating Adjustments	12
Navigating The Control Panel	12
Control Panel Menu Structure	13
DMX Mode	14
Set the Starting DMX Address	14
Select the DMX Channel Mode	14
Slave Mode	14
Auto Mode / Static Colors	14
Speed	14
Fade	14
Strobe	15
Manual Color Mixing	15
Sound Active Mode	15
Dimming Mode	15
Auto Mode / Static Colors	15
Set the Wireless Group ID	15
Auto Mode / Static Colors	15
IR Remote Control Mode	15
Power Output Mode	15
Using the IR Remote Control	16
DMX Channel Values In-Depth	17
Troubleshooting	19
5. Appendix	20
A Quick DMX Lesson	20
Keeping Your SkyBox™ Chroma As Good As New	21
Returns (Gasp!)	21
Shipping Issues	21
Tech Specs	22
Dimensional Drawings	23

LITHIUM-ION BATTERY WARNINGS & INFO

YOU MUST READ THESE SAFETY INSTRUCTIONS AND WARNINGS BEFORE USING OR CHARGING YOUR FIXTURES.

LI-ION BATTERIES ARE VOLATILE. FAILURE TO READ AND FOLLOW THE BELOW INSTRUCTIONS MAY RESULT IN FIRE, PERSONAL INJURY AND DAMAGE TO PROPERTY IF CHARGED OR USED IMPROPERLY. BY PURCHASING AND USING THESE FIXTURES, YOU ASSUME ALL RISKS ASSOCIATED WITH LITHIUM BATTERIES. IF YOU DO NOT AGREE WITH THESE CONDITIONS, PLEASE CONSIDER RETURNING THE FIXTURES

- 1. WARNING! TO REDUCE THE RISK OF INJURY AND/OR EQUIPMENT DAMAGE, DO NOT TAMPER WITH THE CHARGING CIRCUITRY IN THIS FIXTURE.** The use of other types of chargers may result in personal injury or equipment damage. Under no circumstances attempt to connect the battery pack to any power supplies or other equipment that is not specifically and expressly designated for use with this model battery pack.
- 2. NEVER CHARGE UNATTENDED.** When charging Li-Ion batteries, you must always remain in constant observation in order to react to potential problems which may occur. Failure to do so may result in fire. Put the battery in a fireproof container, and charge in an isolated area, away from flammable materials. Always have a fire extinguisher ready for emergency use.
- 3. USE THE LITHIUM ION BATTERY PACK ONLY WITH EQUIPMENT SPECIFICALLY AND EXPRESSLY DESIGNATED FOR USE WITH THIS MODEL BATTERY PACK.** Use with other equipment may result in fire, electric shock, personal injury, and/or damage to equipment.
- 4. AVOID DANGEROUS CONDITIONS AND ENVIRONMENTS.** Do not charge the battery pack in damp or wet conditions. Avoid using the pack in direct exposure to rain or snow. Do not use the battery pack or charger in the presence of explosive gases or flammable materials.
- 5. AVOID USING OR STORING THE BATTERY PACK IN EITHER EXTREME COLD OR EXTREME HOT TEMPERATURES.** The battery pack will disable itself under conditions of extreme heat (above 60 °C) and may not function to full performance under conditions of extreme cold (below -20 °C). Storage at elevated temperatures (above 25 °C) will shorten the life of the battery pack.
- 6. DO NOT BURN OR INCINERATE BATTERY PACKS.** Battery packs may explode causing personal injury, fire, and/or damage. Fumes resulting from burning of battery packs may be toxic.
- 7. DO NOT DROP, CRUSH, IMPACT, OR MECHANICALLY ABUSE BATTERY PACKS.** Cease use of fixtures that have suffered a sharp impact, been dropped, run over, or damaged in any other way. Such impacts may cause internal damage that is not externally visible and that, over time, may cause short circuits, battery cell leakage, or other events that may lead to fire, personal injury, and or equipment damage.
- 8. DO NOT DISASSEMBLE BATTERY PACK.** There are no user serviceable parts within battery packs. Disassembly may result in short circuiting or other damage that may cause fire, personal injury, and/or other damage.
- 9. AVOID CONTACT WITH BATTERY CHEMICALS.** If a battery pack leaks battery chemicals, avoid any contact with skin, eyes, or mouth. In the event of contact with skin, wash immediately with soap and water and rinse with vinegar. For eye contact, begin flushing with clean water, immediately call for medical help, and continue flushing for 20 minutes or until medical help arrives.
- 10. STORE IN A COOL, DRY PLACE.** Avoid leaving the fixture in direct sunlight, vehicle cabs, compartments, or unventilated storage buildings during hot summer conditions. Under extreme temperature conditions damage may occur. Elevated temperatures in general shorten the life of your battery pack.

1. GETTING STARTED

What's In The Box?

- 1 x SkyBox™ Chroma Professional LED Fixture
- This Lovely User Manual

Getting It Out Of The Box

Congratulations on purchasing one of the most unique box-shaped, dual layer LED fixtures you will find anywhere! Now that you've got your SkyBox™ Chroma (or hopefully, *CHROMAs!*), you should carefully unpack the box and check the contents to ensure that all parts are present and in good condition. If anything looks as if it has been damaged in transit, notify the shipper immediately and keep the packing material for inspection. Again, please save the carton and all packing materials. If a fixture must be returned to the factory, it is important that the fixture be returned in the original factory box and packing.

Powering Up!

All fixtures must be powered directly off a switched circuit and **cannot be run off a rheostat (variable resistor) or dimmer circuit, even if the rheostat or dimmer channel is used solely for a 0% to 100% switch.**

AC Voltage Switch - Not all fixtures have a voltage select switch, so please verify that the fixture you receive is suitable for your local power supply. See the label on the fixture or refer to the fixture's specifications chart for more information. A fixture's listed current rating is its average current draw under normal conditions. Check the fixture or device carefully to make sure that if a voltage selection switch exists that it is set to the correct line voltage you will use.

Warning! Verify that the voltage select switch on your unit matches the line voltage applied. Damage to your fixture may result if the line voltage applied does not match the voltage indicated on the voltage selector switch. All fixtures must be connected to circuits with a suitable Ground (Earthing).

Getting A Hold Of Us

If something is wrong, please just visit our website at www.blizzardlighting.com/support and open a support ticket. We'll be happy to help, honest.

Blizzard Lighting
N24 W23750 Watertown Rd Suite B
Waukesha, WI 53188 USA
www.blizzardlighting.com
414-395-8365

Disclaimer: The information and specifications contained in this document are subject to change without notice. Blizzard Lighting™ assumes no responsibility or liability for any errors or omissions that may appear in this user manual. Blizzard Lighting™ reserves the right to update the existing document or to create a new document to correct any errors or omissions at any time. You can download the latest version of this document from www.blizzardlighting.com.

Author:	Date:	Last Edited:	Date:
J. Thomas	6/6/2014	J. Thomas	1/27/2016

SAFETY INSTRUCTIONS



Please read these instructions carefully. They include important information about the installation, usage and maintenance of this product.

- Please keep this User Guide for future use. If you sell the unit to someone else, be sure that they also receive this User Guide.
- ALWAYS make sure that you are connecting to the proper voltage, and that the line voltage you are connecting to is not higher than that stated on the decal or rear panel of the fixture.
- This product is intended for indoor use only.
- To prevent risk of fire or shock, do not expose fixture to rain or moisture.
- Make sure there are no flammable materials close to the unit while operating.
- The unit must be installed in a location with adequate ventilation, at least 20in (50cm) from adjacent surfaces. Be sure that no ventilation slots are blocked.
- ALWAYS disconnect from the power source before servicing or replacing fuse and be sure to replace with same fuse size and type.
- ALWAYS secure fixture using a safety chain. NEVER carry the fixture by its cord. Use its carrying handles.
- DO NOT operate at ambient temperatures higher than 104°F (40°C).
- In the event of a serious operating problem, stop using the unit immediately. NEVER try to repair the unit by yourself. Repairs carried out by unskilled people can lead to damage or malfunction. Please contact the nearest authorized technical assistance center. Always use the same type spare parts.
- NEVER connect the device to a dimmer pack.
- Make sure the power cord is never crimped or damaged.
- Never disconnect the power cord by pulling or tugging on the cord.
- Avoid direct eye exposure to the light source while it is on.

Caution! There are no user serviceable parts inside this unit. Do not open the housing or attempt any repairs yourself. In the unlikely event your unit may require service, please visit www.blizzardlighting.com/support.

2. MEET THE SKYBOX™ CHROMA

CONTROL FEATURES

- RGBAW+UV dual layer color mixing via a total of 9* 15W 6-in-1 LEDs
- White outer casing illuminates via three internal, separately controllable LEDs
- 2.4Ghz built-in wireless DMX receiver
- 512 auto-assigning frequencies in 7 groups
- Ultra Long-life intelion™ lithium-ion battery system
- Variable electronic dimming & strobe
- Built-in color & chase macros via DMX
- Built-in automated programs via master/slave
- Built-in sound active programs
- RGBAW+UV color mixing ability in standalone mode

ADDITIONAL FEATURES

- Power charging LED indicator
- Super-quiet variable-speed internal Fan Cooling
- Dual mounting brackets for positioning flexibility
- Flicker-free constant-current 600hz LED driver
- 3-pin male input and 3-pin female output
- PowerCon™ compatible AC power In/Out connectors

DMX Quick Reference - 18/15/11/6 Channel Modes

Channel	18-Channel	15-Channel	11-Channel	6-Channel
1	Dimmer	R1 Intensity	Dimmer	Full Red Intensity
2	R1 Intensity	G1 Intensity	Full Red Intensity	Full Green Intensity
3	G1 Intensity	B1 Intensity	Full Green Intensity	Full Blue Intensity
4	B1 Intensity	A1 Intensity	Full Blue Intensity	Full Amber Intensity
5	A1 Intensity	W1 Intensity	Full Amber Intensity	Full White Intensity
6	W1 Intensity	UV1 Intensity	Full White Intensity	Full UV Intensity
7	UV1 Intensity	R2 Intensity	Full UV Intensity	---
8	R2 Intensity	G2 Intensity	Strobe	---
9	G2 Intensity	B2 Intensity	Colors + Auto	---
10	B2 Intensity	A2 Intensity	Auto Mode	---
11	A2 Intensity	W2 Intensity	32-bit Dimming	---
12	W2 Intensity	UV2 Intensity	---	---
13	UV2 Intensity	Layer 1 Strobe	---	---
14	Layer 1 Strobe	Layer 2 Strobe	---	---
15	Layer 2 Strobe	32-bit Dimming	---	---
16	Colors + Auto	---	---	---
17	Auto Mode	---	---	---
18	32-bit Dimming	---	---	---

Figure 1: The SkyBox™ Chroma Pin-Up Picture

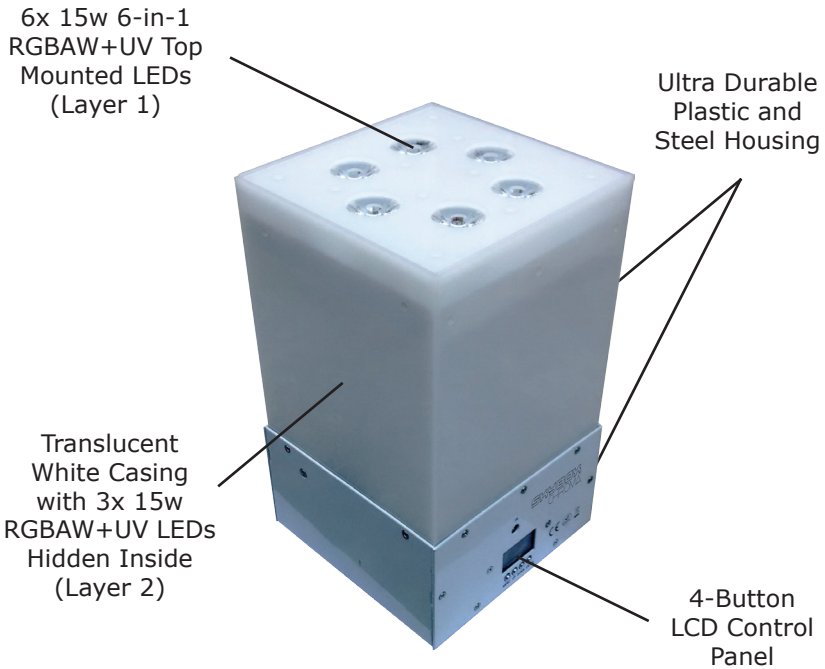
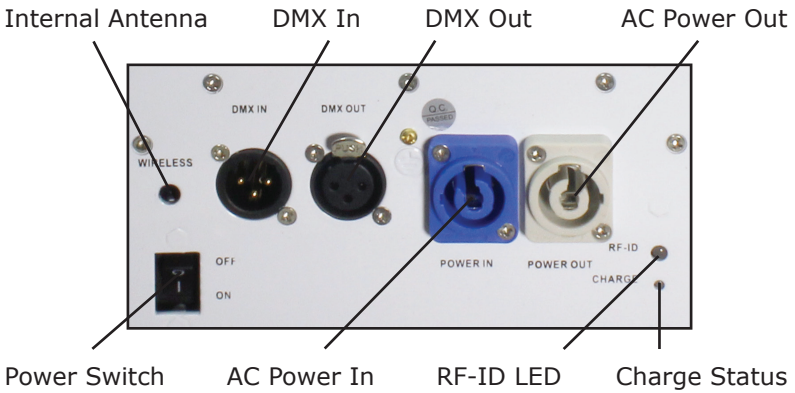

Figure 2: The Rear Connections



3. SETUP

Connecting A Bunch of SkyBox™ Chroma Fixtures

You will need a serial data link to run light shows using a DMX-512 controller or to run shows on two or more fixtures set to sync in master/slave operating mode. The combined number of channels required by all the fixtures on a serial data link determines the number of fixtures the data link can support.

Fixtures on a serial data link must be daisy chained in one single line. Also, connecting more than 32 fixtures on one serial data link without the use of a DMX optically-isolated splitter may result in deterioration of the digital DMX signal. The maximum recommended cable-run distance is 500 meters (1640 ft). The maximum recommended number of fixtures on a serial data link is 32 fixtures.

Data/DMX Cabling

To link fixtures together you'll need data cables. You should use data-grade cables that can carry a high quality signal and are less prone to electromagnetic interference.

For instance, Belden© 9841 meets the specifications for EIA RS-485 applications. Standard microphone cables will "probably" be OK, but note that they cannot transmit DMX data as reliably over long distances. In any event, the cable should have the following characteristics:

*2-conductor twisted pair plus a shield
Maximum capacitance between conductors – 30 pF/ft.
Maximum capacitance between conductor & shield – 55 pF/ft.
Maximum resistance of 20 ohms / 1000 ft.
Nominal impedance 100 – 140 ohms*

Using Skywire™ Wireless DMX

In addition to the unbridled thrill you already received the first time you turned on your fixture, you'll be delighted to know that the SkyBox Chroma's wireless Skywire™ DMX system is designed to work seamlessly with all Blizzard Lighting wireless DMX products.

The SkyBox™ Chroma is equipped to release you from the crushing chains of cabled DMX lighting! It features 512 auto-assigning frequencies in 7 groups allowing up to 7 systems to run simultaneously in the same space, completely free of interference! It's capable of reliable wireless communication for over 1000 feet, line-of-sight!

So first, you'll either need a Blizzard wiCICLE® transmitter, Lightcaster™ wireless transceiver, or any Blizzard Lighting controller that has a built-in wireless transmitter (such as the Kontrol 5 Skywire™) to act as a transmitter for your lights. The 7 DMX receiving frequencies in the SkyBox™ Chroma are designed to match up perfectly with the 7 frequencies of all Blizzard wireless DMX products.



If you're using a Blizzard Lighting controller with built-in wireless DMX transmission, please refer to the instruction manual of that controller for specific information.

Ready to move on? Well alrighty!

1. If you're using an external wireless DMX transmitter like our wiCICLE® transmitter or LightCaster® transceiver, plug it into the "DMX OUT" connector of the controller and verify it is receiving power. If you are using a DMX controller with a built-in DMX transmitter like our KONTROL 5 SKYWIRE™, enable the DMX transmitter on that unit. Please refer to your transmitters user manual for specific instructions on enabling wireless DMX output and/or its changing its channel group selection.
2. Set the wireless channel group to match the transmitter group ID number/color code.
 - a.) Press the **<MENU>** button until the display reads **RF-ID**. (See p. 12-13)
 - b.) Use the **<UP/DOWN>** buttons to select number **1-7**.
 - c.) Press **<ENTER>** to confirm the setting.

Note: The 7-Color Status LED will change color to indicate the current channel group:

- GROUP 1: **RED**
- GROUP 2: **GREEN**
- GROUP 3: **YELLOW**
- GROUP 4: **BLUE**
- GROUP 5: **VIOLET**
- GROUP 6: **CYAN**
- GROUP 7: **WHITE**

NOTE: "GROUP" number also corresponds to the "GROUP" setting on our LightCaster™ wireless DMX transceiver, wiCICLE™ transmitter, and all Blizzard Skywire™ wireless controllers.

3. The LED on the transmitter will blink **RED** slowly until communication is established with the receiver. The status LED on the receiving fixtures will flash **GREEN** slowly until communication is established.
4. Once the clearest channel is auto-selected, the status LEDs will blink quickly on both the transmitter and receiver. NOTE: The color of the SkyBox Chroma's status LED DURING operation does not indicate channel group, instead it indicates whether the unit is transmitting or receiving. **That's It!**

Using the Intelion™ Battery System

The SkyBox™ Chroma features our proprietary Intelion™ Lithium-Ion internal battery system which allows you the flexibility to operate your fixture without AC power for up to 20 hours.

To charge the battery, simply plug the fixture into a power source. The battery will charge whether the fixture is powered on or off. It will even charge while in use! The built-in microprocessor of the battery system controls the charge and overall battery health, so all you need to do is plug and play.

The top section on the LCD display menu shows the battery power level indicator displays the approximate amount of power remaining in the battery. Each power level bar equals 20%. When charging, The CHARGE status LED above the LCD display will illuminate in **RED**, then turn **GREEN** when the charge is complete.

A full charge is obtained after charging for at least 4 hours. The fixture will automatically stop charging when the battery is in optimal condition.

Power Output Mode:

Depending on the needs of any given application, you can select either High Power, Medium Power, or Battery Saver Mode, which allows the fixture to run for a longer time at lower output.

- a.) Press the **<MENU>** button until the display reads **OUT MOD**.
- b.) Use the **<UP/DOWN>** buttons to select **H (100%)**, **M (75%)** or **S (50%)**.
- c.) Press **<ENTER>** to confirm the setting.

Note: With average usage of color fades in High Output Mode, you can expect the battery life to last up to 10+ hours, color jumping 5+ hrs, or full on for 3+ hrs. Display color/fade/chase/strobe, and environmental factors including ambient temperature will all impact battery life.



Cable Connectors

Cables must have a male XLR connector on one end and a female XLR connector on the other end. (Duh!)

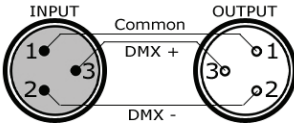

A Word on Termination: DMX is a resilient communication protocol, however errors still occasionally occur. Termination reduces signal errors, and therefore best practices include use of a terminator in all circumstances. If you are experiencing problems with erratic fixture behavior, especially over long signal cable runs, a terminator may help improve performance.

To build your own DMX Terminator:
Obtain a 120-ohm, 1/4-watt resistor, and wire it between pins 2 & 3 of the last fixture. They are also readily available from specialty retailers.

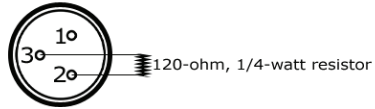

CAUTION: Do not allow contact between the common and the fixture's chassis ground. Grounding the common can cause a ground loop, and your fixture may perform erratically. Test cables with an ohm meter to verify correct polarity and to make sure the pins are not grounded or shorted to the shield or each other.

3-Pin??? 5-Pin??? Huh?!?

If you use a controller with a 5 pin DMX output connector, you will need to use a 5 pin to 3 pin adapter. They are widely available over the internet and from specialty retailers. If you'd like to build your own, the chart below details a proper cable conversion:

Conductor	3-Pin Female (Output)	5-Pin Male (Input)
Ground/Shield	Pin 1	Pin 1
DMX Data (-)	Pin 2	Pin 2
DMX Data (+)	Pin 3	Pin 3
Not Used.	No Connection.	No Connection.
Not Used.	No Connection.	No Connection.

Take It To The Next Level: Setting Up DMX Control

Step 1: Connect the male connector of the DMX cable to the female connector (output) on the controller.



Step 2: Connect the female connector of the DMX cable to the first fixture's male connector (input). *Note:* It doesn't matter which fixture address is the first one connected. We recommend connecting the fixtures in terms of their proximity to the controller, rather than connecting the lowest fixture number first, and so on.

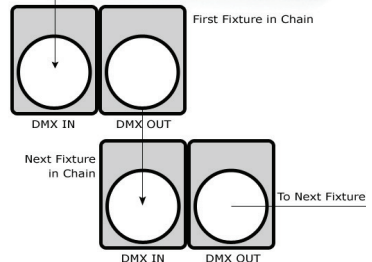

Step 3: Connect other fixtures in the chain from output to input as above. Place a DMX terminator on the output of the final fixture to ensure best communication.

Fixture Linking (Master/Slave Mode)

1. Connect the (male) 3 pin connector side of the DMX cable to the output (female) 3 pin connector of the first fixture.
2. Connect the end of the cable coming from the first fixture which will have a (female) 3 pin connector to the input connector of the next fixture consisting of a (male) 3 pin connector. Then, proceed to connect from the output as stated above to the input of the following fixture and so on.

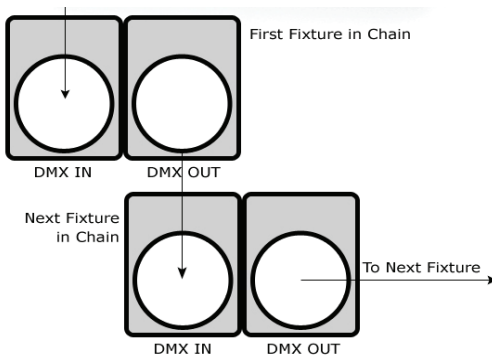

A quick note: Often, the setup for Master-Slave and Standalone operation requires that the first fixture in the chain be initialized for this purpose via either settings in the control panel or DIP-switches. Secondly, the fixtures that follow may also require a slave setting.

Check the **“Operating Adjustments”** section in this manual for complete instructions for this type of setup and configuration.

Mounting & Rigging

This fixture may be mounted in any SAFE position provided there is enough room for ventilation.

It is important never to obstruct the fan or vents pathway. Mount the fixture using a suitable “C” or “O” type clamp. The clamp should be rated to hold at least 10x the fixture’s weight to ensure structural stability. Do not mount to surfaces with unknown strength, and ensure properly “rated” rigging is used when mounting fixtures overhead.

Adjust the angle of the fixture by loosening both knobs and tilting the fixture. After finding the desired position, retighten both knobs.

- When selecting installation location, take into consideration lamp replacement access (if applicable) and routine maintenance.
- Safety cables **MUST ALWAYS** be used.
- Never mount in places where the fixture will be exposed to rain, high humidity, extreme temperature changes or restricted ventilation.

4. OPERATING ADJUSTMENTS

The Control Panel

All the goodies and different modes possible with the SkyBox™ Chroma are accessed by using the control panel on the rear of the fixture. There are 4 control buttons below the LCD display which allow you to navigate through the various control panel menus.

<MENU>

Is used to navigate to the previous higher-level menu item.

<UP>

Scrolls through menu items and numbers in ascending order.

<DOWN>

Scrolls through menu items and numbers in descending order.

<ENTER>

Is used to select and confirm/store the current selection.

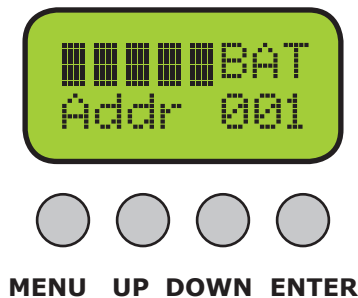

The Control Panel LCD Display shows the menu items you select from the menu map on page #13. When a menu function is selected, the display will show immediately the first available option for the selected menu function. To select a menu item, press **<ENTER>**.

Press the **<MENU>** button repeatedly until you reach the desired menu function. Use the **<UP>** and **<DOWN>** buttons to navigate the menu options. Press the **<ENTER>** button to select the menu function currently displayed, or to enable a menu option. To return to the previous option or menu, press the **<MENU>** button.

Control Panel Menu Structure

Addr	→	001 - 512	To choose the DMX address
CHnd	→	18CH	18 channel DMX mode
	→	15CH	15 channel DMX mode
	→	11CH	11 channel DMX mode
	→	6CH	6 channel DMX mode
AUTO	→	00 - 64	Static Colors (0-62) & Auto Modes (63 & 64)
SPEED	→	00 - 15	Built-in Program Speed (fast <--> slow)
FADE	→	00 - 15	Fade Speed (fast <--> slow)
STROBE	→	00 - 15	Strobe speed (slow <--> fast)
MANUAL	→	<ENTER>	Custom Color Mixing
RED	→	000 - 512	Red dimmer (0% <--> 100%)
GREEN	→	000 - 255	Green dimmer (0% <--> 100%)
BLUE	→	000 - 255	Blue dimmer (0% <--> 100%)
AMBER	→	000 - 255	Amber dimmer (0% <--> 100%)
WHITE	→	000 - 255	White dimmer (0% <--> 100%)
UV	→	000 - 255	UV dimmer (0% <--> 100%)
SOUND	→	<ENTER>	Sound active mode
DIMMER	→	0 - 4	Dimming mode (0-4)
RF-ID	→	1 - 7	Selects wireless channel group (1-7)
IR MODE	→	<ENTER>	Set to use IR remote control (sold separately)
OUT MOD	→	<ENTER>	Power output mode: H=100%, M=75%, S=50%

DMX Mode

Allows the unit to be controlled by any universal DMX controller.

Tip: Push the <MENU> button repeatedly to scroll through all of the top tier menu items.

Set the Starting DMX Address:

The default mode for the fixture is DMX, so the first menu item that you can edit is the starting DMX address.

- 1.) Navigate the menu using the <MENU> button until you reach **Addr**.
- 2.) Use the <UP/DOWN> buttons to select a DMX channel from **001-512**.
- 3.) Press the <ENTER> button to confirm.

Select the DMX Channel Mode:

- 1.) Navigate the menu using the <MENU> button until you reach **CHnd**.
- 2.) Use the <UP/DOWN> buttons to select either **6CH**, **11CH**, **15CH**, or **18CH** mode.
- 3.) Press the <ENTER> button to confirm.

Slave Mode: Set slave fixtures to: **Addr: 001**, **15CH** mode to ensure correct reception of master signals. The master will be the 1st fixture in the DMX chain.

Auto Mode / Static Colors

- 1.) Navigate the menu using the <MENU> button until you reach **AUTO**.
- 2.) Use the <UP/DOWN> buttons to select any preset color from **00-62**, or select **63** to automatically run through all of the colors (color snap), or **64** (color fade).
- 3.) If you choose auto run, you can then adjust the color change speed, or adjust the color fade speed.

Speed:

- a.) Press the <MENU> button until you reach the **Speed** menu item.
- b.) Then use the <UP/DOWN> buttons to select a speed setting from **00-15** (fast <--> slow).
- c.) Press the <ENTER> button to confirm.

Fade:

- a.) Press the <MENU> button until you reach the **Fade** menu item.
- b.) Then use the <UP/DOWN> buttons to select a speed setting from **00-15** (fast <--> slow).
- c.) Press the <ENTER> button to confirm.

63 Preset Colors:

00	Red	21	Red+Green+Blue	42	Red+Green+Blue+White
01	Green	22	Red+Green+Amber	43	Red+Green+Blue+UV
02	Blue	23	Red+Green+White	44	Red+Green+Amber+White
03	Amber	24	Red+Green+UV	45	Red+Green+Amber+UV
04	White	25	Red+Blue+Amber	46	Red+Green+White+UV
05	UV	26	Red+Blue+White	47	Red+Blue+Amber+White
06	Red+Green	27	Red+Blue+UV	48	Red+Blue+Amber+UV
07	Red+Blue	28	Red+Amber+White	49	Red+Blue+White+UV
08	Red+Amber	29	Red+Amber+UV	50	Red+Amber+White+UV
09	Red+White	30	Red+White+UV	51	Green+Blue+Amber+White
10	Red+UV	31	Green+Blue+Amber	52	Green+Blue+Amber+UV
11	Green+Blue	32	Green+Blue+White	53	Green+Blue+White+UV
12	Green+Amber	33	Green+Blue+UV	54	Green+Amber+White+UV
13	Green+White	34	Green+Amber+White	55	Blue+Amber+White+UV
14	Green+UV	35	Green+Amber+UV	56	Red+Green+Blue+Amber+White
15	Blue+Amber	36	Green+White+UV	57	Red+Green+Blue+Amber+UV
16	Blue+White	37	Blue+Amber+White	58	Red+Green+Blue+White+UV
17	Blue+UV	38	Blue+Amber+UV	59	Red+Green+Amber+White+UV
18	Amber+White	39	Blue+White+UV	60	Red+Blue+Amber+White+UV
19	Amber+UV	40	Amber+White+UV	61	Green+Blue+Amber+White+UV
20	White+UV	41	Red+Green+Blue+Amber	62	All Colors: R+G+B+A+W+UV

Strobe (White)

- 1.) Navigate the menu using the **<MENU>** button until you reach **Strobe**.
- 2.) Use the **<UP/DOWN>** buttons to select the strobe speed from **00-15**.
- 3.) Press the **<ENTER>** button to confirm.

Manual Color Mixing:

Mix your own custom colors using the R/G/B/A/W/UV intensity level setting.

Red:

- 1.) Navigate the menu using the **<MENU>** button until you reach **Red**.
- 2.) Use the **<UP/DOWN>** buttons to adjust red **000-255**. (0% <--> 100%).
- 3.) Press the **<ENTER>** button to confirm.

Green:

- 1.) Navigate the menu using the **<MENU>** button until you reach **Green**.
- 2.) Use the **<UP/DOWN>** buttons to adjust green **000-255**. (0% <--> 100%).
- 3.) Press the **<ENTER>** button to confirm.

Blue:

- 1.) Navigate the menu using the **<MENU>** button until you reach **Blue**.
- 2.) Use the **<UP/DOWN>** buttons to adjust blue **000-255**. (0% <--> 100%).
- 3.) Press the **<ENTER>** button to confirm.

Amber:

- 1.) Navigate the menu using the **<MENU>** button until you reach **Amber**.
- 2.) Use the **<UP/DOWN>** buttons to adjust amber: **000-255**. (0% <--> 100%).
- 3.) Press the **<ENTER>** button to confirm.

White:

- 1.) Navigate the menu using the **<MENU>** button until you reach **White**.
- 2.) Use the **<UP/DOWN>** buttons to adjust white **000-255**. (0% <--> 100%).
- 3.) Press the **<ENTER>** button to confirm.

UV:

- 1.) Navigate the menu using the **<MENU>** button until you reach **UV**.
- 2.) Use the **<UP/DOWN>** buttons to adjust UV **000-255**. (0% <--> 100%).
- 3.) Press the **<ENTER>** button to confirm.

Sound Active Mode

- 1.) Navigate the menu using the **<MENU>** button until you reach **Sound...**
- 2.) Press the **<ENTER>** button to confirm.

Dimming Mode

Select from 5 different dimming curve choices. These each allow for different amounts of steps to achieve smoother (and slower) dimming capabilities.

- 1.) Navigate the menu using the **<MENU>** button until you reach **Dimmer**.
- 2.) Use the **<UP/DOWN>** buttons to select from **0-4**.
- 3.) Press the **<ENTER>** button to confirm.

Mode 0 = 8-bit, 256 dimming steps
Mode 1 = 32-bit, 0-25% intensity range
Mode 2 = 32-bit, 0-50% intensity range
Mode 3 = 32-bit, 0-75% intensity range
Mode 4 = 32-bit, full intensity dimming

Set Wireless Group ID

- 1.) Navigate the menu using the **<MENU>** button until you reach **RF-ID**.
- 2.) Select the RF-ID **1-7**. (See page 9)
- 3.) Press the **<ENTER>** button to confirm.

IR Remote Control Mode (remote control sold separately)

- 1.) Navigate the menu using the **<MENU>** button until you reach **IR MODE**.
- 2.) You are now in IR mode. The fixture will now respond to the IR remote control. (See page 16)

Power Output Mode

- 1.) Navigate the menu using the **<MENU>** button until you reach **OUT MOD**.
- 2.) Select **0** (High: 100%), **1** (Medium: 75%), or **2** (Battery Saver: 50%) output mode.
- 3.) Press the **<ENTER>** button to confirm. (See page 9)

Using the IR Remote Control (sold separately)

You need to set the fixture to "IR mode" via the LCD control panel prior to using the IR remote control. To do this, just repeatedly press the <MENU> button to navigate the LCD display menu until it reads "IR MODE", then push the <ENTER> button.

Then here's what to do:

Blackout - The top left red colored button labeled <BLACKOUT> on the remote control will turn off the LEDs, regardless of what mode you are currently running. Push the blackout button again to return to its previous mode.

Auto Run - The auto run button <A> sets the fixture to run in auto mode. You can adjust the speed by pressing the speed button <SP>, then use the <+/-> buttons to adjust the speed accordingly.

Sound Active Mode - Pressing the <SA> button will cause the fixture to self destruct. No, really it just sets the fixture to run in sound active mode.

Strobe Mode - The <F> button sets the fixture to run in strobe / flash mode. You can adjust the strobe rate by pressing the <SP> button, then use the <+/-> buttons to adjust the speed accordingly.

Built-in Programs - Press the <PROG> button to run in built-in program mode. You can cycle through different built-in programs by using the <+/-> buttons. To adjust the speed of the built-in program, press the speed button <SP>, then use the <+/-> buttons to adjust the speed accordingly.

Set Address - Press the <S> button to begin setting the starting DMX address. Then use the <+/-> buttons to adjust the starting DMX channel from 001-512. Press the <D> button to confirm DMX mode.

DMX Mode - Pressing the <D> button sets the fixture to run in DMX mode. The currently set address will be used for the starting address. To change the starting DMX channel, see the above "Set Address" instructions.

Slave Mode - Want to set this fixture(s) as a slave unit(s) via remote? No problem, just push the <SL> button. And note, the first fixture in the DMX chain will serve as the master fixture.

LCD Backlight - Press the edit button <E> to turn on the LCD backlight. The LCD backlight illumination off after 20 seconds.

Color Mixing:

Red Intensity - Press the <1> button, then press the <+/-> buttons to adjust intensity level.

Green Intensity - Press the <2> button, then press the <+/-> buttons to adjust intensity level.

Blue Intensity - Press the <3> button, then press the <+/-> buttons to adjust intensity level.

Amber Intensity - Press the <4> button, then press the <+/-> buttons to adjust intensity level.

White Intensity - Press the <5> button, then press the <+/-> buttons to adjust intensity level.

UV Intensity - Press the <6> button, then press the <+/-> buttons to adjust intensity level.

Static Colors:

Full On - Press the <7> button for full RGBAW+UV intensity.

Magenta - Press the <8> button for magenta color.

Aqua - Press the <9> button for aqua color.

UV - Press the <0> button for ultraviolet lighting.

Backspace Button - Press the <←> in any mode to activate IR MODE.

Enter - The <↵> button is used to save a selected user setting.



DMX Values In-Depth (6-Channel Mode)

Ch.	Value	What It Does
1	000 <--> 255	Red Intensity (0% <--> 100%)
2	000 <--> 255	Green Intensity (0% <--> 100%)
3	000 <--> 255	Blue Intensity (0% <--> 100%)
4	000 <--> 255	Amber Intensity (0% <--> 100%)
5	000 <--> 255	White Intensity (0% <--> 100%)
6	000 <--> 255	UV Intensity (0% <--> 100%)

DMX Values In-Depth (11-Channel Mode)

Ch.	Value	What It Does				
1	000 <--> 255	Dimmer (0% <--> 100%)				
2	000 <--> 255	Red Intensity (0% <--> 100%)				
3	000 <--> 255	Green Intensity (0% <--> 100%)				
4	000 <--> 255	Blue Intensity (0% <--> 100%)				
5	000 <--> 255	Amber Intensity (0% <--> 100%)				
6	000 <--> 255	White Intensity (0% <--> 100%)				
7	000 <--> 255	UV Intensity (0% <--> 100%)				
8	000 <--> 010 011 <--> 255	No Function Strobe Speed (slow <--> fast)				
9	Value	What It Does	Value	What It Does	Value	What It Does
	001 <--> 015	Dimming	079 <--> 081	R+G+B	145 <--> 147	R+G+B+UV
	016 <--> 018	R	082 <--> 084	R+G+A	148 <--> 150	R+G+A+W
	019 <--> 021	G	085 <--> 087	R+G+W	151 <--> 153	R+G+A+UV
	022 <--> 024	B	088 <--> 090	R+G+UV	154 <--> 156	R+G+W+UV
	025 <--> 027	A	091 <--> 093	R+B+A	157 <--> 159	R+B+A+W
	028 <--> 030	W	094 <--> 096	R+B+W	160 <--> 162	R+B+A+UV
	031 <--> 033	UV	097 <--> 099	R+B+UV	163 <--> 165	R+B+W+UV
	034 <--> 036	R+G	100 <--> 102	R+A+W	166 <--> 168	R+A+W+UV
	037 <--> 039	R+B	103 <--> 105	R+A+UV	169 <--> 171	R+B+A+W
	040 <--> 042	R+A	106 <--> 108	R+W +UV	172 <--> 174	G+B+A+UV
	043 <--> 045	R+W	109 <--> 111	G+B+A	175 <--> 177	G+B+W+UV
	046 <--> 048	R+UV	112 <--> 114	G+B+W	178 <--> 180	G+A+W+UV
	049 <--> 051	G+B	115 <--> 117	G+B+UV	181 <--> 183	B+A+W+UV
	052 <--> 054	G+A	118 <--> 120	G+A+W	184 <--> 186	R+G+B+A+W
	055 <--> 057	G+W	121 <--> 123	G+A+UV	187 <--> 189	R+G+B+A+UV
	058 <--> 060	G+UV	124 <--> 126	G+W+UV	190 <--> 192	R+G+B+W+UV
	061 <--> 063	B+A	127 <--> 129	B+A+W	193 <--> 195	R+B+A+W+UV
	064 <--> 066	B+W	130 <--> 132	B+A+UV	196 <--> 198	R+B+A+W+UV
	067 <--> 069	B+UV	133 <--> 135	B+W+UV	199 <--> 201	G+B+A+W+UV
070 <--> 072	A+W	136 <--> 138	A+W+UV	202 <--> 204	Full ON	
073 <--> 075	A+UV	139 <--> 141	R+G+B+A	205 <--> 229	Auto Snap	
076 <--> 078	W+UV	142 <--> 144	R+G+B+W	230 <--> 255	Auto Fade	
10	000 <--> 015 016 <--> 250 251 <--> 255	No Function Color Fade (slow <--> fast) Sound Active				
11	000 <--> 005 006 <--> 055 056 <--> 105 106 <--> 155 156 <--> 205 206 <--> 255	32-Bit Dimmer As set in the control menu display Mode 0 = 8-bit, 256 dimming steps Mode 1 = 32-bit, 0-25% intensity range Mode 2 = 32-bit, 0-50% intensity range Mode 3 = 32-bit, 0-75% intensity range Mode 4 = 32-bit, full intensity dimming				

DMX Values In-Depth (15-Channel Mode)

Ch.	Value	What It Does
1	000 <--> 255	Layer 1 Red Intensity (0% <--> 100%)
2	000 <--> 255	Layer 1 Green Intensity (0% <--> 100%)
3	000 <--> 255	Layer 1 Blue Intensity (0% <--> 100%)
4	000 <--> 255	Layer 1 Amber Intensity (0% <--> 100%)
5	000 <--> 255	Layer 1 White Intensity (0% <--> 100%)
6	000 <--> 255	Layer 1 UV Intensity (0% <--> 100%)
7	000 <--> 255	Layer 2 Red Intensity (0% <--> 100%)
8	000 <--> 255	Layer 2 Green Intensity (0% <--> 100%)
9	000 <--> 255	Layer 2 Blue Intensity (0% <--> 100%)
10	000 <--> 255	Layer 2 Amber Intensity (0% <--> 100%)
11	000 <--> 255	Layer 2 White Intensity (0% <--> 100%)
12	000 <--> 255	Layer 2 UV Intensity (0% <--> 100%)
13	000 <--> 010 011 <--> 255	No Function Layer 1 Strobe Speed (slow <--> fast)
14	000 <--> 010 011 <--> 255	No Function Layer 2 Strobe Speed (slow <--> fast)
15	000 <--> 005 006 <--> 055 056 <--> 105 106 <--> 155 156 <--> 205 206 <--> 255	32-Bit Dimmer As set in the control menu display Mode 0 = 8-bit, 256 dimming steps Mode 1 = 32-bit, 0-25% intensity range Mode 2 = 32-bit, 0-50% intensity range Mode 3 = 32-bit, 0-75% intensity range Mode 4 = 32-bit, full intensity dimming

DMX Values In-Depth (18-Channel Mode)

Ch.	Value	What It Does
1	000 <--> 255	Dimmer (0% <--> 100%)
2	000 <--> 255	Layer 1 Red Intensity (0% <--> 100%)
3	000 <--> 255	Layer 1 Green Intensity (0% <--> 100%)
4	000 <--> 255	Layer 1 Blue Intensity (0% <--> 100%)
5	000 <--> 255	Layer 1 Amber Intensity (0% <--> 100%)
6	000 <--> 255	Layer 1 White Intensity (0% <--> 100%)
7	000 <--> 255	Layer 1 UV Intensity (0% <--> 100%)
8	000 <--> 255	Layer 2 Red Intensity (0% <--> 100%)
9	000 <--> 255	Layer 2 Green Intensity (0% <--> 100%)
10	000 <--> 255	Layer 2 Blue Intensity (0% <--> 100%)
11	000 <--> 255	Layer 2 Amber Intensity (0% <--> 100%)
12	000 <--> 255	Layer 2 White Intensity (0% <--> 100%)
13	000 <--> 255	Layer 2 UV Intensity (0% <--> 100%)

(18-Channel Mode, Continued)

Ch.	Value	What It Does					
14	000 <--> 010 011 <--> 255	No Function Layer 1 Strobe Speed (slow <--> fast)					
15	000 <--> 010 011 <--> 255	No Function Layer 2 Strobe Speed (slow <--> fast)					
16	Value	What It Does	Value	What It Does	Value	What It Does	
	001 <--> 015 016 <--> 018 019 <--> 021 022 <--> 024 025 <--> 027 028 <--> 030 031 <--> 033 034 <--> 036 037 <--> 039 040 <--> 042 043 <--> 045 046 <--> 048 049 <--> 051 052 <--> 054 055 <--> 057 058 <--> 060 061 <--> 063 064 <--> 066 067 <--> 069 070 <--> 072 073 <--> 075 076 <--> 078	Dimming R G B A W UV R+G R+B R+A R+W R+UV G+B G+A G+W G+UV B+A B+W B+UV A+W A+UV W+UV	079 <--> 081 082 <--> 084 085 <--> 087 088 <--> 090 091 <--> 093 094 <--> 096 097 <--> 099 100 <--> 102 103 <--> 105 106 <--> 108 109 <--> 111 112 <--> 114 115 <--> 117 118 <--> 120 121 <--> 123 124 <--> 126 127 <--> 129 130 <--> 132 133 <--> 135 136 <--> 138 139 <--> 141 142 <--> 144	R+G+B R+G+A R+G+W R+G+UV R+B+A R+B+W R+B+UV R+A+W R+A+UV R+W +UV G+B+A G+B+W G+B+UV G+A+W G+A+UV G+W+UV B+A+W B+A+UV B+W+UV A+W+UV R+G+B+A R+G+B+W	145 <--> 147 148 <--> 150 151 <--> 153 154 <--> 156 157 <--> 159 160 <--> 162 163 <--> 165 166 <--> 168 169 <--> 171 172 <--> 174 175 <--> 177 178 <--> 180 181 <--> 183 184 <--> 186 187 <--> 189 190 <--> 192 193 <--> 195 196 <--> 198 199 <--> 201 202 <--> 204 205 <--> 229 230 <--> 255	R+G+B+UV R+G+A+W R+G+A+UV R+B+W+UV R+B+A+W R+B+A+UV R+B+W+UV R+A+W+UV G+B+A+W G+B+A+UV G+B+W+UV G+A+W+UV B+A+W+UV R+G+B+A+W R+G+B+A+UV R+G+B+A+UV R+B+A+W+UV R+B+A+W+UV Full ON Auto Snap Auto Fade	
	17	000 <--> 015 016 <--> 255	No Function Color Fade (slow <--> fast)				
	18	000 <--> 005 006 <--> 055 056 <--> 105 106 <--> 155 156 <--> 205 206 <--> 255	32-Bit Dimmer As set in the control menu display Mode 0 = 8-bit, 256 dimming steps Mode 1 = 32-bit, 0-25% intensity range Mode 2 = 32-bit, 0-50% intensity range Mode 3 = 32-bit, 0-75% intensity range Mode 4 = 32-bit, full intensity dimming				

Troubleshooting

Symptom	Solution
Fixture Auto-Shut Off	Check the fan in the fixture. If it is stopped or moving slower than normal, the unit may have shut itself off due to high heat. This is to protect the fixture from overheating. Clear the fan of obstructions, or return the unit for service.
No Light Output	Check to ensure fixture is operating under correct mode, IE sound active/auto/DMX/Etc., if applicable.
Chase Speed Too Fast/Slow	Check to ensure proper setup of speed adjustment.
No Power	Check fuse, AC cord and circuit for malfunction.
No Response to Audio	Verify that the fixture is in "Sound Active" mode. Adjust Audio Sensitivity, If Applicable.
Fixture Not Responding / Responding Erratically	Make sure all connectors are seated properly and securely. Use Only DMX Cables and/or check cables for defects Install a Terminator. Reset fixture(s).

If your problem isn't listed, or if problems persist, please open a support ticket at: www.blizzardlighting.com/support.

5. APPENDIX

A Quick Lesson On DMX

DMX (aka DMX-512) was created in 1986 by the United States Institute for Theatre Technology (USITT) as a standardized method for connecting lighting consoles to lighting dimmer modules. It was revised in 1990 and again in 2000 to allow more flexibility. The Entertainment Services and Technology Association (ESTA) has since assumed control over the DMX512 standard. It has also been approved and recognized for ANSI standard classification.

DMX covers (and is an abbreviation for) Digital MultipleXed signals. It is the most common communications standard used by lighting and related stage equipment.

DMX provides up to 512 control "channels" per data link. Each of these channels was originally intended to control lamp dimmer levels. You can think of it as 512 faders on a lighting console, connected to 512 light bulbs. Each slider's position is sent over the data link as an 8-bit number having a value between 0 and 255. The value 0 corresponds to the light bulb being completely off while 255 corresponds to the light bulb being fully on.

DMX data is transmitted at 250,000 bits per second using the RS-485 transmission standard over two wires. As with microphone cables, a grounded cable shield is used to prevent interference with other signals.

There are five pins on a DMX connector: a wire for ground (cable shield), two wires for "Primary" communication which goes from a DMX source to a DMX receiver, and two wires for a "Secondary" communication which goes from a DMX receiver back to a DMX source. Generally, the "Secondary" channel is not used so data flows only from sources to receivers. Hence, most of us are most familiar with DMX-512 as being employer over typical 3-pin "mic cables," although this does not conform to the defined standard.

DMX is connected using a daisy-chain configuration where the source connects to the input of the first device, the output of the first device connects to the input of the next device, and so on. The standard allows for up to 32 devices on a single DMX link.

Each receiving device typically has a means for setting the "starting channel number" that it will respond to. For example, if two 6-channel fixtures are used, the first fixture might be set to start at channel 1 so it would respond to DMX channels 1 through 6, and the next fixture would be set to start at channel 7 so it would respond to channels 7 through 12.

The greatest strength of the DMX communications protocol is that it is very simple and robust. It involves transmitting a reset condition (indicating the start of a new "packet"), a start code, and up to 512 bytes of data. Data packets are transmitted continuously. As soon as one packet is finished, another can begin with no delay if desired (usually another follows within 1 ms). If nothing is changing (i.e. no lamp levels change) the same data will be sent out over and over again. This is a great feature of DMX -- if for some reason the data is not interpreted the first time around, it will be re-sent shortly.

Not all 512 channels need to be output per packet, and in fact, it is very uncommon to find all 512 used. The fewer channels are used, the higher the "refresh" rate. It is possible to get DMX refreshes at around 1000 times per second if only 24 channels are being transmitted. If all 512 channels are being transmitted, the refresh rate is around 44 times per second.

In summary, since its design and evolution in the 1980's DMX has become the standard for lighting control. It is flexible, robust, and scalable, and its ability to control everything from dimmer packs to moving lights to foggers to lasers makes it an indispensable tool for any lighting designer or lighting performer.

Keeping Your SkyBox™ Chroma As Good As New

The fixture you've received is a rugged, tough piece of pro lighting equipment, and as long as you take care of it, it will take care of you. That said, like anything, you'll need to take care of it if you want it to operate as designed. You should absolutely keep the fixture clean, especially if you are using it in an environment with a lot of dust, fog, haze, wild animals, wild teenagers or spilled drinks.

Cleaning the optics routinely with a suitable glass cleaner will greatly improve the quality of light output. Keeping the fans free of dust and debris will keep the fixture running cool and prevent damage from overheating.

In transit, keep the fixtures in cases. You wouldn't throw a prized guitar, drumset, or other piece of expensive gear into a gear trailer without a case, and similarly, you shouldn't even think about doing it with your shiny new light fixtures.

Common sense and taking care of your fixtures will be the single biggest thing you can do to keep them running at peak performance and let you worry about designing a great light show, putting on a great concert, or maximizing your client's satisfaction and "wow factor." That's what it's all about, after all!

Returns (Gasp!)

We've taken a lot of precautions to make sure you never even have to worry about sending a defective unit back, or sending a unit in for service. But, like any complex piece of equipment designed and built by humans, once in a while, something doesn't go as planned. If you find yourself with a fixture that isn't behaving like a good little fixture should, you'll need to obtain a Return Authorization (RA).

Don't worry, this is easy. Just open a support ticket at www.blizzardlighting.com/support, and we'll issue you an RA. Then, you'll need to send the unit to us using a trackable, pre-paid freight method. We suggest using USPS Priority or UPS. Make sure you carefully pack the fixture for transit, and whenever possible, use the original box & packing for shipping.

When returning your fixture for service, be sure to include the following:

- 1.) Your contact information (Name, Address, Phone Number, Email address).
- 2.) The RA# issued to you
- 3.) A brief description of the problem/symptoms.

We will, at our discretion, repair or replace the fixture. Please remember that any shipping damage which occurs in transit to us is the customer's responsibility, so pack it well!

Shipping Issues

Damage incurred in shipping is the responsibility of the shipper, and must be reported to the carrier immediately upon receipt of the items. Claims must be made within seven (7) days of receipt.

Tech Specs!

Weight & Dimensions							
Width	6.81 inches (173 mm)						
Depth	6.81 inches (173 mm)						
Height	12 inches (305.8 mm)						
Weight	9.3 lbs (4.5 kg)						
Power							
Operating Voltage	100-240VAC, 50-60 Hertz						
Power Consumption	40W, .57A, PF:.62						
Light Source							
LED	9x 15W 6-in-1 LEDs 100,000 hours.						
Optical							
Beam Angle	25 degree optics standard 26 degree beam 30 degree field						
Luminous Intensity (Top LEDs)	Lux/m	Red	Green	Blue	Amber	White	All
	1m	1405	1788	2000	1087	3230	3510
	2m	380	462	498	262	692	1000
Thermal							
Max. Operating Temp.	104 degrees F (40 degrees C) ambient						
Control							
Protocol	USITT DMX-512						
DMX Channels	6 / 11 / 15 / 18						
Input	3-pin XLR Male						
Output	3-pin XLR Female						
Other Operating Modes	Standalone, Master/Slave, Sound Active, Color Preset						
Other Information							
It is hard to eat angrily.							
Warranty	2-year limited warranty, does not cover mal-function caused by damage to LEDs.						

DISCLAIMER:

The power connector fitted to the fixture and fixture cord are designed for compatibility with products manufactured by Neutrik AG, Neutrik USA and their related entities, however they are not manufactured by, affiliated with or endorsed by Neutrik AG, Neutrik USA, or any related entity. Neutrik® and powerCON® are registered trademarks of Neutrik AG.

Dimensional Drawings

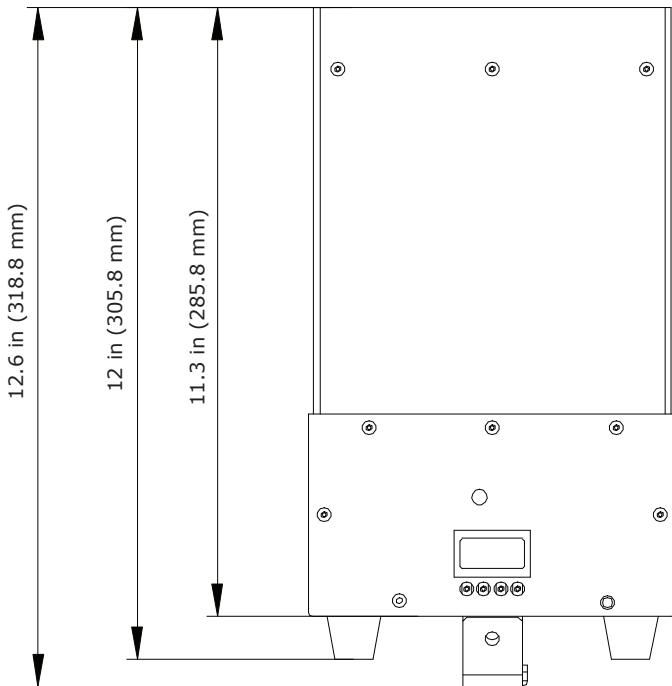
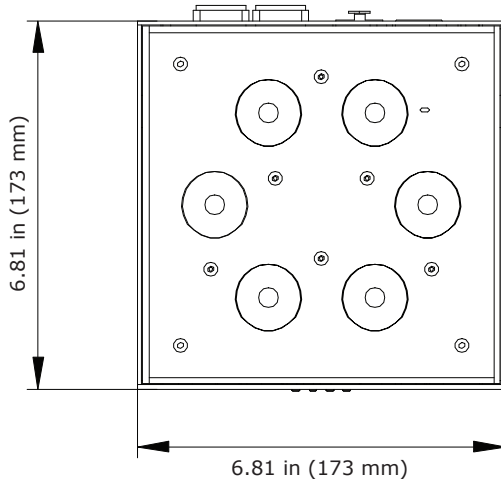



Enjoy your product!
Our sincerest thanks for your purchase!
--The team @ Blizzard Lighting