

USER MANUAL

MODEL:

PA-240Z

240W Power Amplifier

PA-120Z

120W Power Amplifier

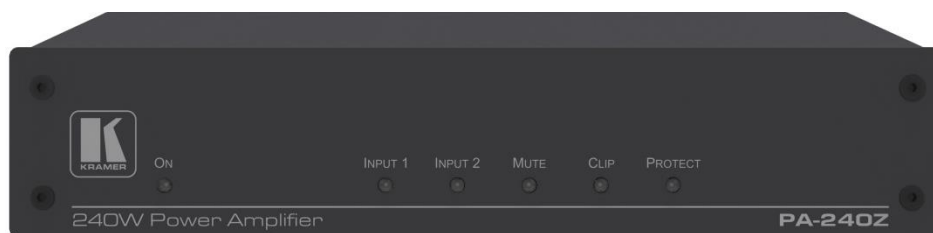

Contents

Introduction	1
Getting Started	1
Overview	2
Typical Applications	3
Defining the PA-240Z 240W Power Amplifier	4
Connecting the PA-240Z	6
Connecting the Output to a Balanced/Unbalanced Stereo Audio Acceptor	7
Connecting a Balanced/Unbalanced Stereo Audio Source to the Balanced Input	8
Connecting to PA-240Z via RS-232	8
RJ-45 Pinout	8
Connecting PA-240Z via the Ethernet Port	9
Operating the PA-240Z	12
Setting the DIP-Switches	12
Adjusting the Master Volume	12
Using the Embedded Web Pages	13
Setting the Speaker Output Parameters	15
Setting the Line Level Output Parameters	17
Selecting Hi-Z Mono Settings	18
Changing Standby Settings	19
Setting Device Parameters	19
Managing Web Page Security	23
Viewing the About Page	26
Technical Specifications	27
Default Communication Parameters	28
Protocol 3000	29
Understanding Protocol 3000	30
Kramer Protocol 3000 Syntax	31
Protocol 3000 Commands	32

Introduction

Welcome to Kramer Electronics! Since 1981, Kramer Electronics has been providing a world of unique, creative, and affordable solutions to the vast range of problems that confront the video, audio, presentation, and broadcasting professional on a daily basis. In recent years, we have redesigned and upgraded most of our line, making the best even better!

Getting Started

We recommend that you:

- Unpack the equipment carefully and save the original box and packaging materials for possible future shipment.
- Review the contents of this user manual.



Go to www.kramerav.com/downloads/PA-240Z to check for up-to-date user manuals, application programs, and to check if firmware upgrades are available (where appropriate).

Achieving the Best Performance

- Use only good quality connection cables (we recommend Kramer high-performance, high-resolution cables) to avoid interference, deterioration in signal quality due to poor matching, and elevated noise levels (often associated with low quality cables).
- Do not secure the cables in tight bundles or roll the slack into tight coils.
- Avoid interference from neighboring electrical appliances that may adversely influence signal quality.
- Position your Kramer **PA-240Z** away from moisture, excessive sunlight and dust.



This equipment is to be used only inside a building. It may only be connected to other equipment that is installed inside a building.

Safety Instructions



Caution: There are no operator serviceable parts inside the unit.

Warning: Use only the power cord that is supplied with the unit.

Warning: Do not open the unit. High voltages can cause electrical shock! Servicing by qualified personnel only.

Warning: Disconnect the power and unplug the unit from the wall before installing.

Recycling Kramer Products

The Waste Electrical and Electronic Equipment (WEEE) Directive 2002/96/EC aims to reduce the amount of WEEE sent for disposal to landfill or incineration by requiring it to be collected and recycled. To comply with the WEEE Directive, Kramer Electronics has made arrangements with the European Advanced Recycling Network (EARN) and will cover any

costs of treatment, recycling and recovery of waste Kramer Electronics branded equipment on arrival at the EARN facility. For details of Kramer's recycling arrangements in your particular country go to our recycling pages at www.kramerav.com/support/recycling.

Overview

Congratulations on purchasing your Kramer **PA-240Z 240W Power Amplifier** and/or **PA-120Z 120W Power Amplifier**.



Although this user manual describes the **PA-240Z** it refers to both **PA-240Z** and **PA-120Z**, unless specified otherwise.

PA-240Z is a high-performance Hi-Z (70V/100V) and Lo-Z (4/8Ω), network controllable power amplifier featuring balanced and unbalanced inputs and also a line-level balanced output. This powerful amplifier is suitable for large-scale applications.

PA-240Z is housed in a desktop sized enclosure and two units can be mounted in a 1U rack space using the optional **RK-1** adapter.

PA-240Z provides exceptional quality and user-friendly operation.

Exceptional Quality

- For **PA-240Z**:
 - A single channel of 240W into a 70V/100V line.
 - 2 channels of 120W into 4/8Ω.
- For **PA-120Z**:
 - A single channel of 120W into a 70V/100V line.
 - 2 channels of 60W into 4/8Ω.
- Individual input mix, EQ and HPF (High-Pass Filter) per output.
- Built-in 3-band parametric EQ.

User-friendly Operation

- Status LED indicators for the selected input, output muted and clipped signal on the output.
- Over-current, short circuit or over-heat protection – The PROTECT LED lights and the device shuts down until correct operational conditions are regained.
- Auto-standby with adjustable threshold.
- Controllable via RS-232 and IP.

Typical Applications

The PA-240Z is ideal for the following typical applications:

- Medium to large meeting rooms.
- Auditoriums and lecture halls.
- Court rooms.
- Retail stores and shopping centers.
- Hotel lobbies.
- Transportation hubs.

Defining the PA-240Z 240W Power Amplifier

This section defines the PA-240Z.

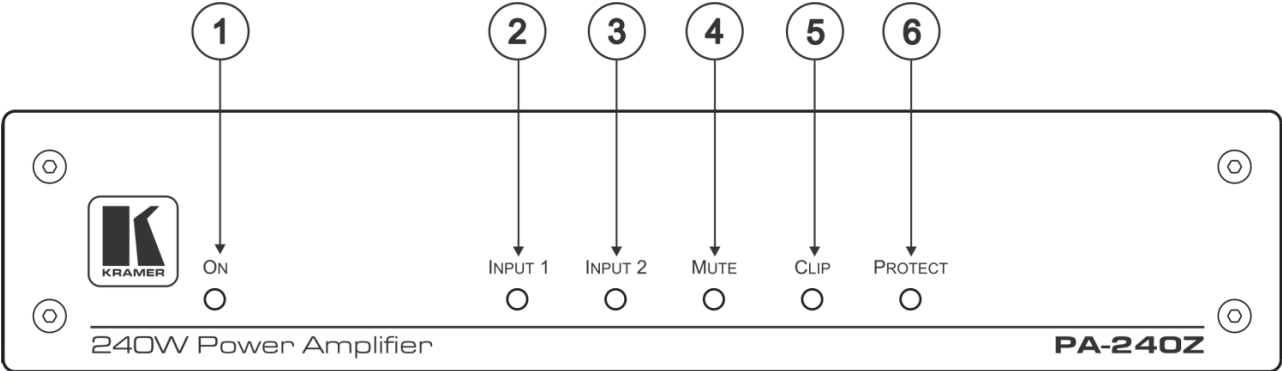

Figure 1: PA-240Z 240W Power Amplifier Front Panel

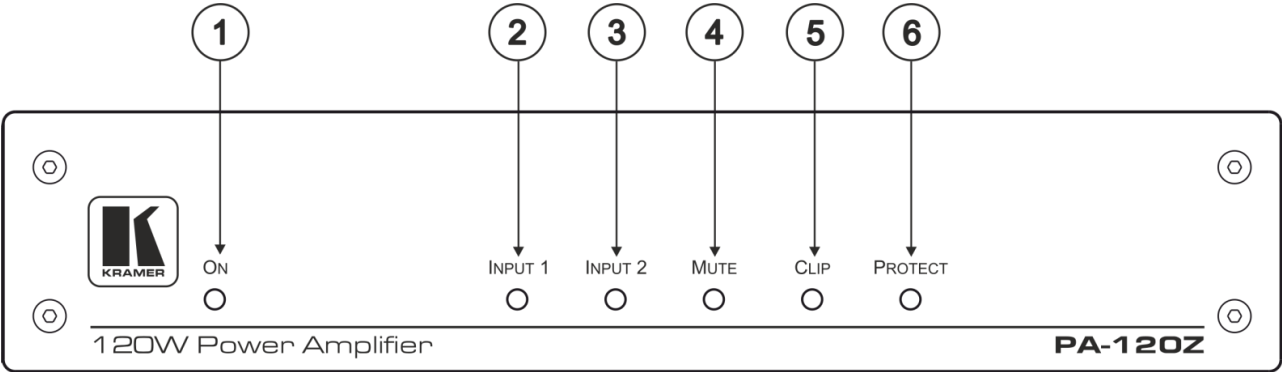

Figure 2: PA-120Z 120W Power Amplifier Front Panel

#	Feature	Function
①	ON LED	Lights green when powered on and orange when in standby.
②	INPUT 1 LED	Lights green when a signal is present on input 1.
③	INPUT 2 LED	Lights green when a signal is present on input 2.
④	MUTE	Lights red when the output is muted, off when unmuted.
⑤	CLIP LED	Lights red when the signal is clipped on the output and creating distortion. (When clipping is detected, lower the volume until the LED turns off.)
⑥	PROTECT LED	Lights red in case of over-current / short circuit / over-heat. The device shuts down until correct operational conditions are regained.

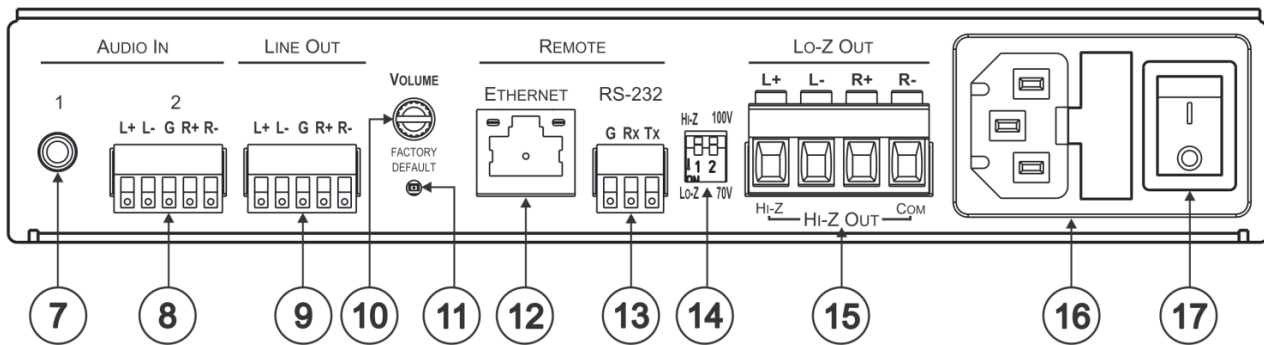

Figure 3: PA-240Z and PA-120Z Rear Panel

#	Feature	Function
7	AUDIO IN Connectors (1 and 2)	Unbalanced Stereo Audio 3.5mm Mini Jack
8		Balanced Stereo Audio Terminal Block Connector
9	LINE OUT Balanced Stereo Audio Terminal Block Connector	Connect to a balanced, stereo audio acceptor (for example, amplified speakers).
10	VOLUME Control Trimmer	Master volume for speaker output – rotate to set the maximum amplifier volume. The volume level set here defines the maximum level of the speaker output volume on the embedded web pages (see Setting the Speaker Output Parameters on page 15).
11	FACTORY DEFAULT Button	Press during power-up of the device to return to the factory default settings, including all the configurations and network settings.
12	ETHERNET RJ-45 Connector	Connect to an ETHERNET LAN.
13	RS-232 (G, Tx, Rx) Port	Connect to the RS-232 connector on the A/V equipment or a PC or other Serial Controller.
14	Hi-Z/Lo-Z and 100V/70V DIP-Switches	Set to Hi-Z for high impedance and Lo-Z for low impedance. In Hi-Z, set to 70V or 100V.
15	Lo-Z/Hi-Z Out Terminal Block Connectors	For Lo-Z: connect stereo output to Lo-Z speakers: L+ and L- to the left speaker; R+R- to the right speaker. For Hi-Z (70V or 100V): connect Hi-Z and COM to mono Hi-Z speakers. The speaker can output either the Left side of the audio input or reduce the stereo input to a mono signal (see Selecting Hi-Z Mono Settings on page 18).
16	Power Connector with Fuse	AC connector, enabling power supply to the unit.
17	POWER Switch	Switch for turning the unit on or off.

Connecting the PA-240Z



Always switch off the power to each device before connecting it to your **PA-240Z**. After connecting your **PA-240Z**, connect its power and then switch on the power to each device.

To connect the PA-240Z as illustrated in the example in [Figure 4](#):

1. Connect the audio sources. For example:
 - An unbalanced stereo audio source to the AUDIO IN 1 3.5mm mini jack ⁽⁷⁾ (for example, an MP3 player).
 - A balanced stereo audio source to the AUDIO IN 2 5-pin terminal block connector ⁽⁸⁾ (for example, the Kramer **VP-444** Switcher/Scaler).
2. Connect the LINE OUT balanced stereo audio 5-pin terminal block connector ⁽⁹⁾ to a balanced stereo input (for example, an additional **PA-240Z** device).
3. Connect the Hi-Z OUT or Lo-Z OUT 4-pin terminal block connector ⁽¹⁵⁾ as follows:
 - For Hi-Z connection: connect Hi-Z and COM terminal blocks to the + and – terminals of a mono speaker (for example, the **Galil 8-C** ceiling speakers, daisy chained). The speakers either output the left side (L+, L-) of the audio input or the stereo input reduced to a mono signal (see [Selecting Hi-Z Mono Settings](#) on page [18](#)).
 - For Lo-Z connection: connect the L+ and L- connectors to the left-side speaker and the R+ and R- connectors to the right-side speaker (for example, the **Yarden 6-O** speakers).
4. Set the DIP-switches ⁽¹⁴⁾:
 - For Hi-Z operation: Set DIP-switch 1 to Hi-Z and then set DIP-switch 2 to 70V or 100V.
 - For Lo-Z operation: Set DIP-switch 1 to Lo-Z.
5. If required, connect:
 - A PC via RS-232 ⁽¹³⁾, see [Connecting to PA-240Z via RS-232](#) on page [8](#).
 - The ETHERNET port ⁽¹²⁾, see [Connecting PA-240Z via the Ethernet Port](#) on page [9](#).
6. Connect the power cord (not shown in [Figure 4](#)).

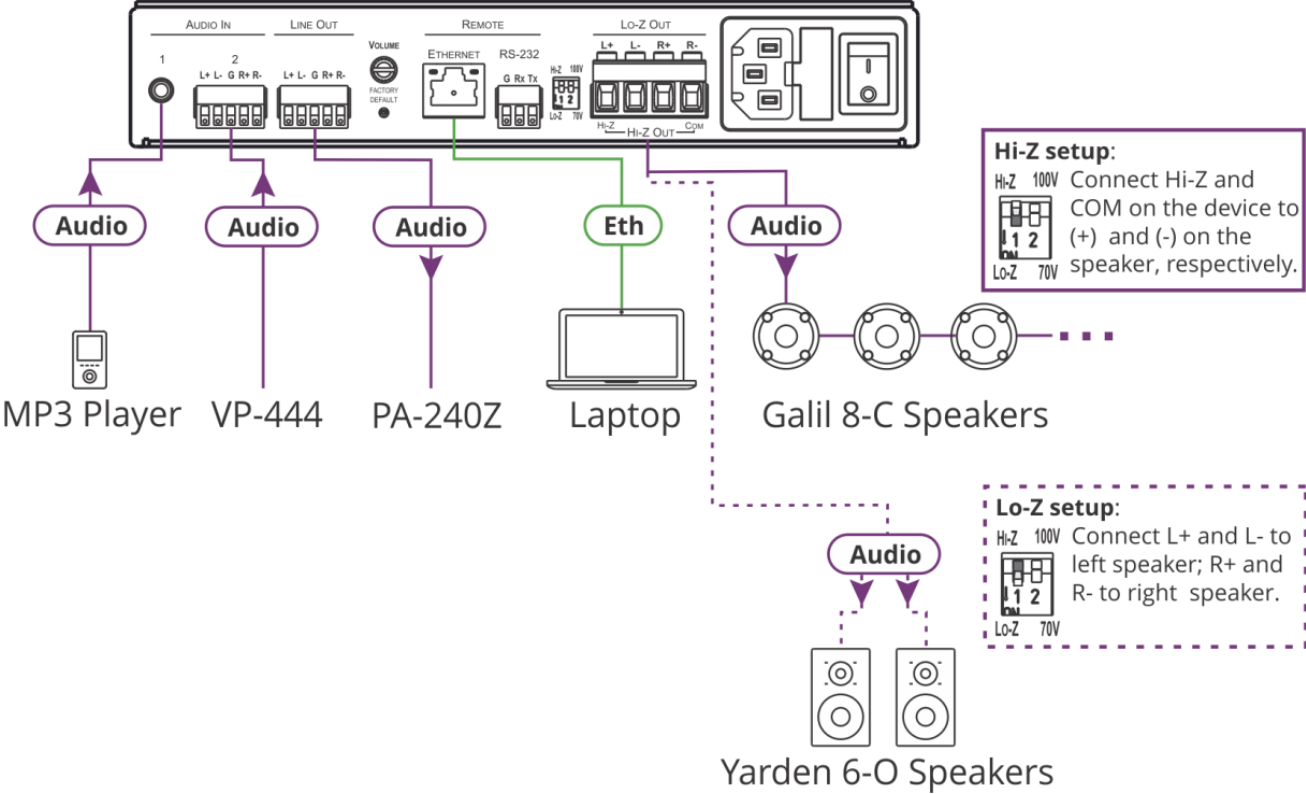

Figure 4: Connecting to the PA-240Z Rear Panel

Connecting the Output to a Balanced/Unbalanced Stereo Audio Acceptor

The following are the pinouts for connecting the output to a balanced or unbalanced stereo audio acceptor:

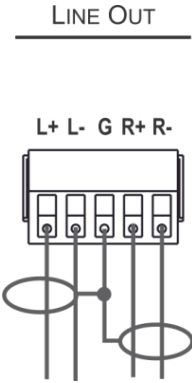

Figure 5: Connecting to a Balanced Stereo Audio Acceptor

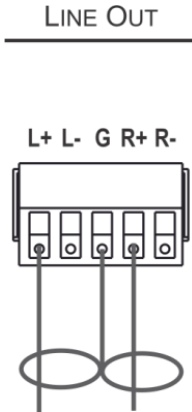

Figure 6: Connecting to an Unbalanced Stereo Audio Acceptor

Connecting a Balanced/Unbalanced Stereo Audio Source to the Balanced Input

The following are the pinouts for connecting a balanced or unbalanced stereo audio source to the balanced input:

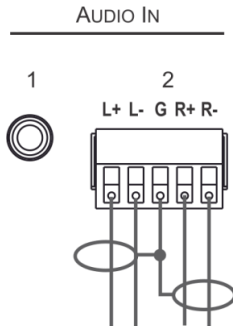

Figure 7: Connecting a Balanced Stereo Audio Source to the Balanced Input

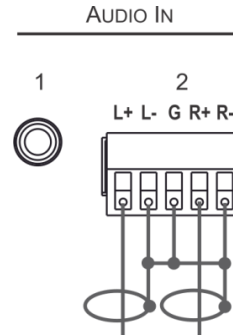

Figure 8: Connecting an Unbalanced Stereo Audio Source to the Balanced Input

Connecting to PA-240Z via RS-232

You can connect to the PA-240Z via an RS-232 connection ⁽¹³⁾ using, for example, a PC.

From the RS-232 9-pin D-sub serial port connect:

- Pin 2 to the TX pin on the PA-240Z RS-232 terminal block
- Pin 3 to the RX pin on the PA-240Z RS-232 terminal block
- Pin 5 to the G pin on the PA-240Z RS-232 terminal block

RJ-45 Pinout

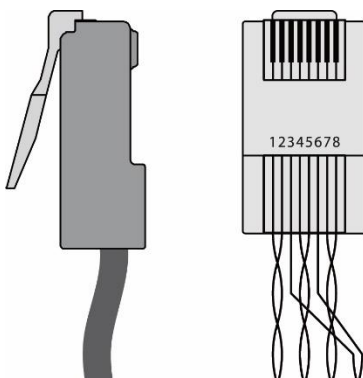

PIN EIA /TIA 568B	
PIN	Wire Color
1	Orange / White
2	Orange
3	Green / White
4	Blue
5	Blue / White
6	Green
7	Brown / White
8	Brown

Connecting PA-240Z via the Ethernet Port

You can connect to the **PA-240Z** via Ethernet using either of the following methods:

- Directly to the PC using a crossover cable (see [Connecting the Ethernet Port Directly to a PC](#) on page 9).
- Via a network hub, switch, or router, using a straight-through cable (see [Connecting the Ethernet Port via a Network Hub or Switch](#) on page 11).



If you want to connect via a router and your IT system is based on IPv6, speak to your IT department for specific installation instructions.

Connecting the Ethernet Port Directly to a PC

You can connect the Ethernet port of the **PA-240Z** directly to the Ethernet port on your PC using a crossover cable with RJ-45 connectors.



This type of connection is recommended for identifying the **PA-240Z** with the factory configured default IP address

After connecting the **PA-240Z** to the Ethernet port, configure your PC as follows:

1. Click **Start > Control Panel > Network and Sharing Center**.
2. Click **Change Adapter Settings**.
3. Highlight the network adapter you want to use to connect to the device and click **Change settings of this connection**.

The Local Area Connection Properties window for the selected network adapter appears as shown in [Figure 9](#).

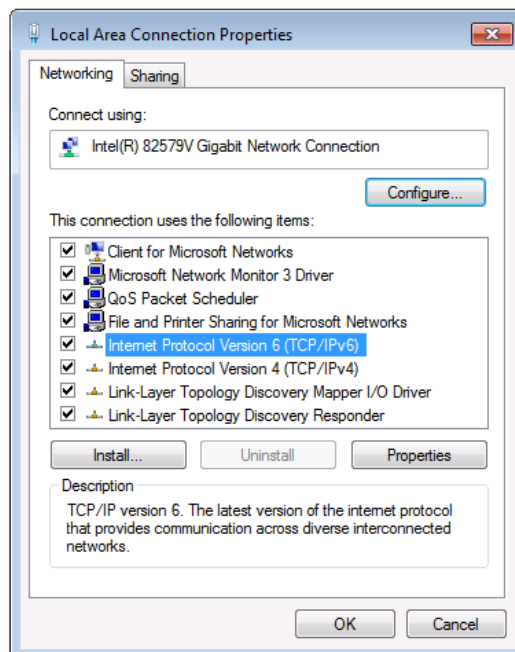

Figure 9: Local Area Connection Properties Window

4. Highlight either **Internet Protocol Version 6 (TCP/IPv6)** or **Internet Protocol Version 4 (TCP/IPv4)** depending on the requirements of your IT system.

5. Click **Properties**.

The Internet Protocol Properties window relevant to your IT system appears as shown in [Figure 10](#) or [Figure 11](#).

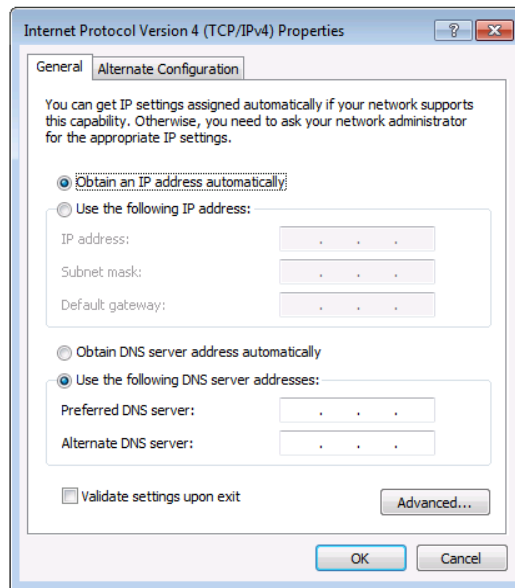

Figure 10: Internet Protocol Version 4 Properties Window

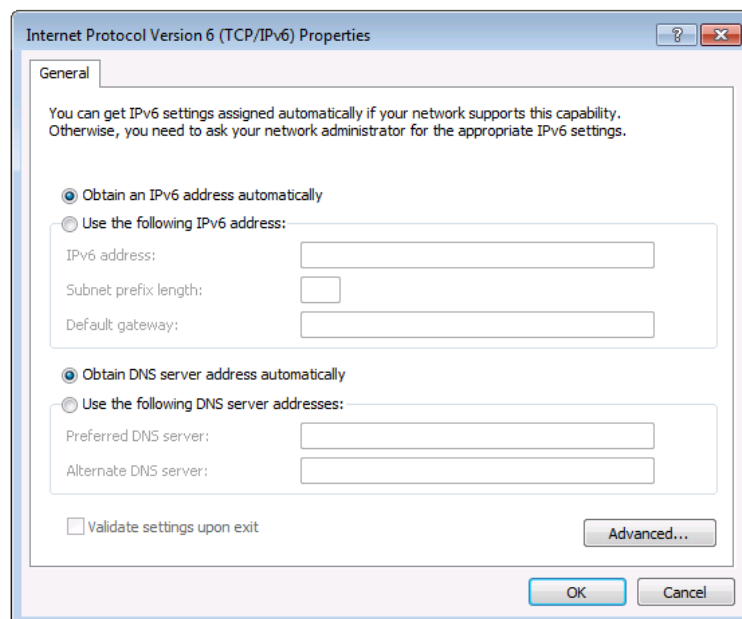

Figure 11: Internet Protocol Version 6 Properties Window

6. Select **Use the following IP Address** for static IP addressing and fill in the details as shown in [Figure 12](#).

For TCP/IPv4 you can use any IP address in the range 192.168.1.1 to 192.168.1.255 (excluding 192.168.1.39) that is provided by your IT department.

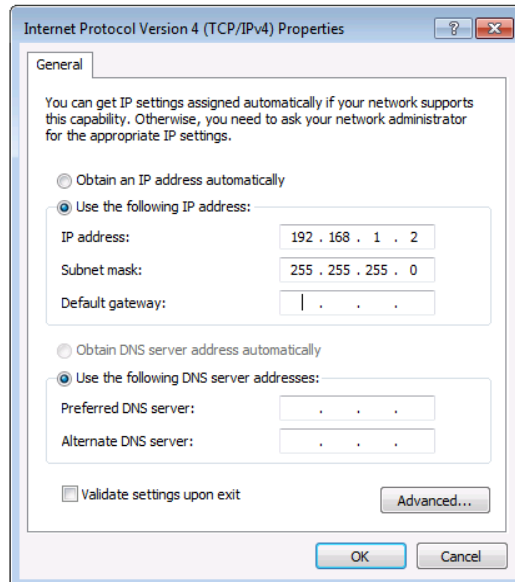

Figure 12: Internet Protocol Properties Window

7. Click **OK**.
8. Click **Close**.

Connecting the Ethernet Port via a Network Hub or Switch

You can connect the Ethernet port of the PA-240Z to the Ethernet port on a network hub or using a straight-through cable with RJ-45 connectors.

Control Configuration via the Ethernet Port

To control several units via Ethernet, connect the Master unit (Device 1) via the Ethernet port to the Ethernet port of your PC. Use your PC provide initial configuration of the settings (see [Connecting PA-240Z via the Ethernet Port](#) on page 9).

Operating the PA-240Z

This section describes the following operations:

- [Setting the DIP-Switches](#) on page [12](#).
- [Adjusting the Master Volume](#) on page [12](#).

Setting the DIP-Switches

By default, the DIP-switches are set to Hi-Z and 100V.

DIP-Switch #	Setting	Note
1	Set to Hi-Z for high impedance configurations.	Use when connecting mono speakers in daisy-chain.
	Set to Lo-Z for low impedance configurations.	Use when connecting to a single pair of speakers, one to the left and one to the right.
2	When in Hi-Z , set either to 70V or 100V according to your requirements.	

Adjusting the Master Volume

Use the VOLUME trimmer  on the rear panel to set the maximum level for the speaker output speaker output. Adjust the master volume (speaker output) via the web pages, see [Setting the Master Volume and Balance](#) on page [16](#).

Using the Embedded Web Pages

Control the **PA-240Z** via the web pages which are accessed using a Web browser and an Ethernet connection.

Before attempting to connect:

- Perform the procedures described in [Connecting PA-240Z via the Ethernet Port](#) on page [9](#).
- Ensure that your browser is supported.

The following operating systems and Web browsers are supported:

OS	Browser
Windows (7 and higher)	IE
	FireFox
	Chrome
Mac/iOS	Safari
Android	Chrome

The **PA-240Z** web pages enable performing the following:

- [Setting the Speaker Output Parameters](#) on page [15](#).
- [Setting the Line Level Output Parameters](#) on page [17](#).
- [Selecting Hi-Z Mono Settings](#) on page [18](#).
- [Changing Standby Settings](#) on page [19](#).
- [Setting Device Parameters](#) on page [19](#).
- [Managing Web Page Security](#) on page [23](#).
- [Viewing the About Page](#) on page [26](#).

To browse the PA-240Z web pages:

1. Open your Internet browser.
2. Type the IP address of the device in the address bar of your browser. For example, the default IP address:



The Authentication window appears (if security is enabled):

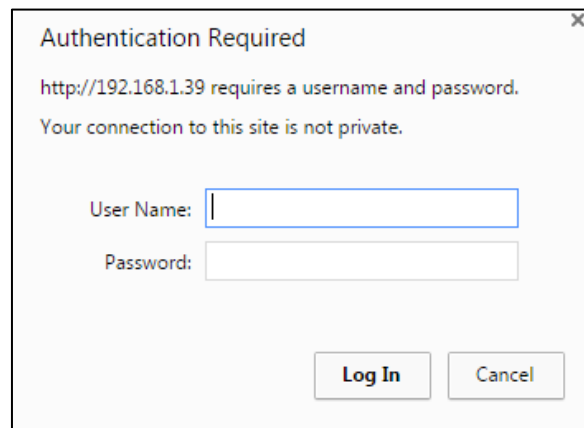

Figure 13: Using the Embedded Web Pages – Authentication Window

3. Enter the **User Name** (Admin, by default) and **Password** (Admin, by default) and click **OK**.

The **Speaker Output** page appears:

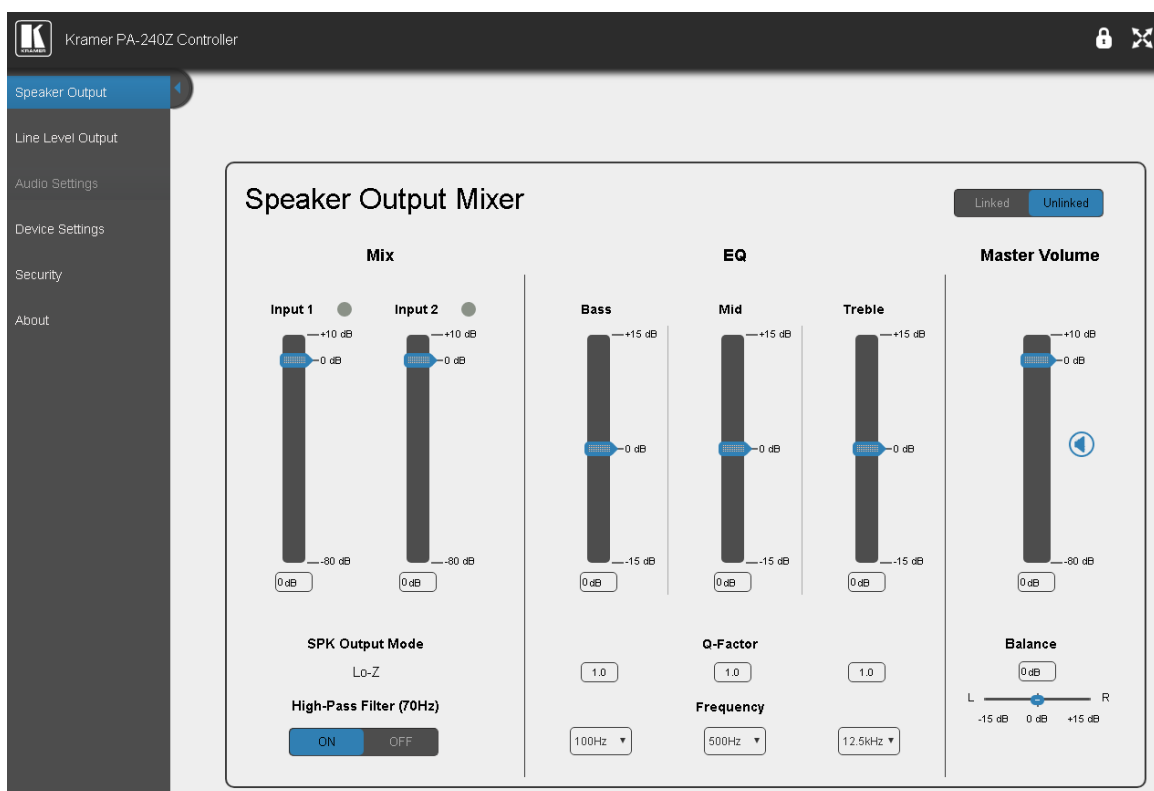



Figure 14: Speaker Output Page with Navigation List on Left

4. Click the desired web page or click the arrow to hide the navigation list.

Setting the Speaker Output Parameters

Use the Speaker Output page to set the speaker input signals mixing and the output parameters.

 **PA-240Z** enables automatically setting the line level output parameters according to the speaker output parameters (see [Setting the Line Level Output Parameters](#) on page 17).

The Speaker Output Mixer enables performing the following operations:

- [Mixing the Input Signal Levels](#) on page 15.
- [Setting Equalization Levels](#) on page 16.
- [Setting the Master Volume and Balance](#) on page 16.

Mixing the Input Signal Levels

 The indication buttons next to Input 1 and Input 2 appear green when there is an active signal on that input.

To set the Mixing Level:

1. In the Navigation pane, click **Speaker Output**. The Speaker Output page appears.

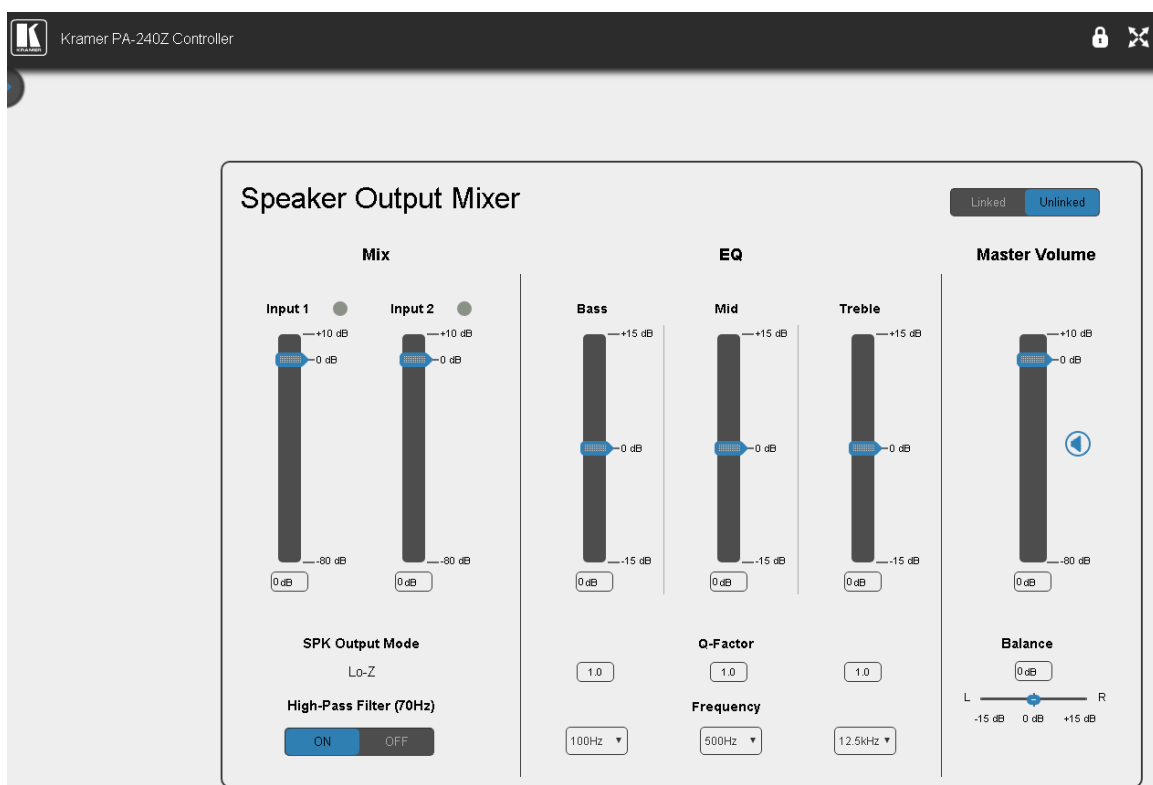

Figure 15: Speaker Output Page

2. In the **Mix** column, use the sliders to set the mixing level for each input or enter their value below the sliders.
3. Set the High-Pass Filter **ON** or **OFF** to cut-off frequencies lower than 70Hz.

 To save energy, enable the High-Pass Filter when outputting soft background music or vocal sounds.

Setting Equalization Levels

We recommend that you first set the frequencies, then the Q and finally the gain for the **Bass**, **Mid** and **Treble** ranges.

To set EQ levels:

1. In the navigation pane click **Speaker Output**. The Speaker Output page appears.
2. In the EQ column set the following:
 - Set the **Bass** [60Hz, 80Hz, 100Hz or 200Hz] **Mid** [500Hz, 1kHz, 1.5kHz or 2.5kHz] and **Treble** [10kHz, 12.5kHz, 15kHz or 17.5kHz] frequency.
 - Set the **Bass**, **Mid** and **Treble** Q-Factor [0.1 to 16]. The lower the Q value, the higher the bandwidth.
 - Use the sliders to set **Bass**, **Mid** and **Treble** equalization or enter their value below the sliders.

Setting the Master Volume and Balance

The maximum master volume level of the speaker output is set via the trimmer  on the rear panel, see [Adjusting the Master Volume](#) on page [12](#).

In the Master Volume column:

- Use the slider to set the speaker audio level.
- Click  to mute/unmute the output volume.
- Set the left right balance on the speaker output.

Setting the Line Level Output Parameters

PA-240Z enables automatically setting the line level output parameters according to the speaker output parameters see [Setting the Speaker Output Parameters](#) on page 15 or setting them manually via the Line Level Output page.

To set the line level output parameters independently (unlinked to speaker output parameters):

1. In the Navigation pane, click **Speaker Output**. The Speaker Output page appears.
2. Click **Unlinked**.
3. In the Navigation pane, click **Line Level Output**. The Line Level Output page appears.

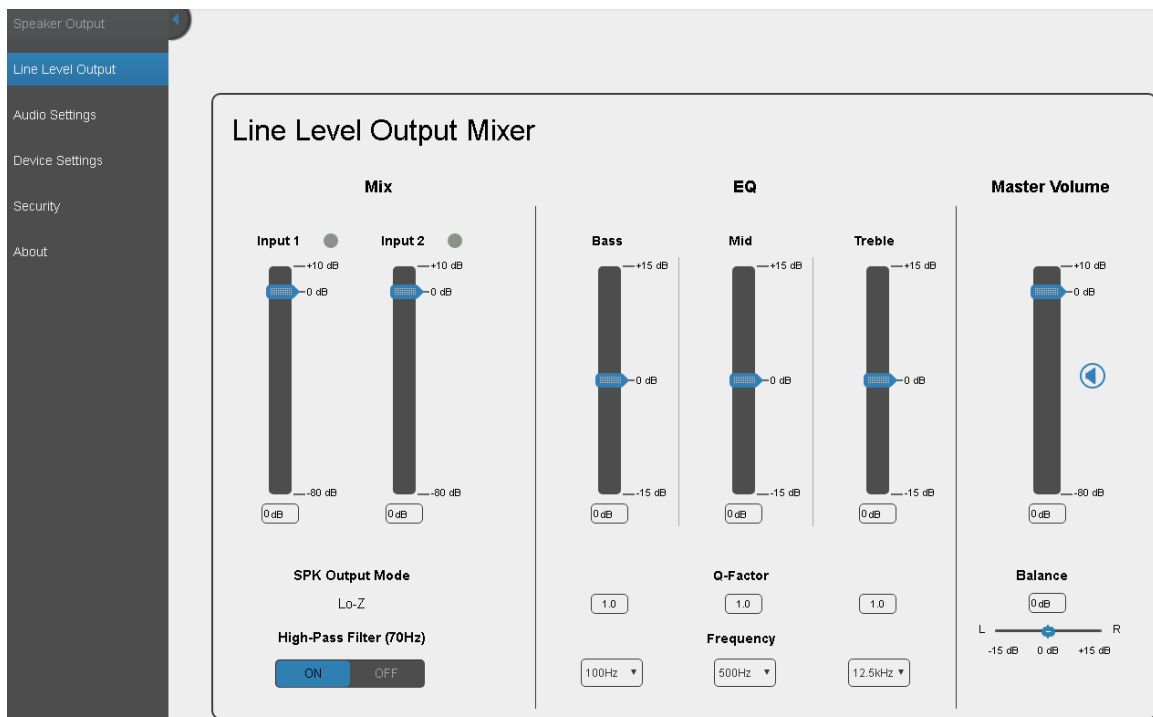

Figure 16: Line Level Output Page

4. Set the line level parameters in the Line Level Output page, as instructed for [Setting the Speaker Output Parameters](#) on page 15.

Selecting Hi-Z Mono Settings

To select Hi-Z mono settings:

1. In the Navigation pane, click **Audio Settings**. The Audio Settings page appears.
2. Set the Hi-Z reduction to mono to one of the following:
 - Select **Left only** to use left audio in connectors
 - Select **Stereo Down Mix** to reduce the stereo input to mono.

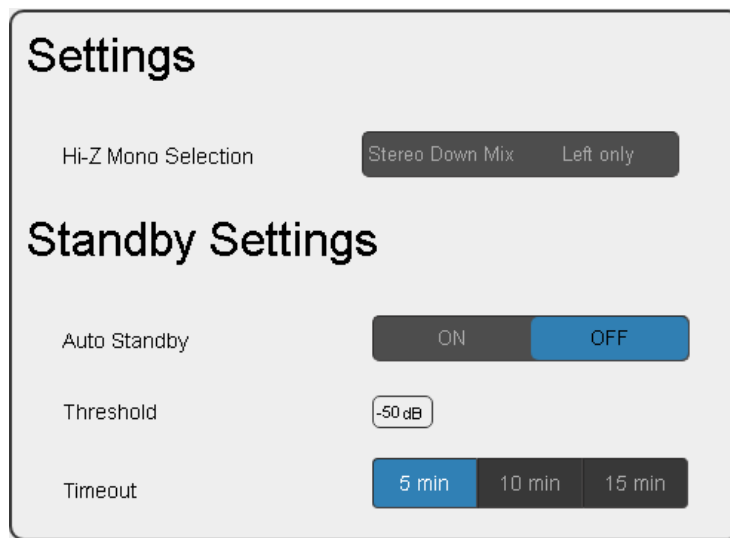

Figure 17: Audio Settings Page

Changing Standby Settings

To change standby settings:

1. In the Navigation pane, click **Audio Settings**. The Audio Settings page appears ([Figure 17](#)).
2. Define the **Standby Settings**:
 - Set auto standby to **ON** or **OFF**.
 - Type the audio threshold to initiate auto standby.
 - Set the standby timeout to **5**, **10** or **15** minutes.

Entering Standby

The device goes into standby when both of the following conditions are met:

- Auto Standby is set to ON in the webpage.
- The signal on the input stays below the threshold for the selected period of time (5, 10, or 15 minutes).



The threshold can be set by entering a valid number (-100 dB to 0 dB) into the Threshold textbox (see [Figure 17](#)), or using protocol 3000 command [AUD-IN-CONF](#) on page [38](#).

Exiting Standby

The device immediately goes out of standby when either of the following conditions are met:

- Auto Standby is set to OFF in the webpage.

-or-

- The input signal goes above the threshold.

Setting Device Parameters

The Device Settings Web page shows the device details, such as name, MAC address and firmware version and also enables performing the following functions:

- Changing the name of the unit by typing the name in the **Unit name** text box.
- [Changing the Ethernet Settings](#) on page [20](#).
- [Saving and Loading Settings](#) on page [21](#).
- [Performing a Factory Reset](#) on page [22](#).

Changing the Ethernet Settings

To change the Ethernet settings, if required:

1. In the Navigation pane, click **Device Settings**. The Device Settings page appears:

The screenshot shows the 'Device Settings' page with the following fields and controls:

- Unit name:** PA-240Z-0001 (with a 'Set' button)
- Model:** PA-240Z
- Firmware version:** 1.8.40011
- Serial number:** 05170104700001
- Ethernet Settings:**
 - DHCP:** A toggle switch currently set to OFF.
 - IP address:** 192 . 168 . 1 . 39
 - Mask address:** 255 . 255 . 0 . 0
 - Gateway address:** 192 . 168 . 0 . 1 (with a 'Set' button below it)
 - Mac address:** 00-1d-56-03-62-75
 - UDP port:** 50000 (with a 'Set' button)
 - TCP port:** 5000 (with a 'Set' button)
- All settings:** 'Load...' and 'Save...' buttons, and a 'Factory reset' button.

Figure 18: Device Settings Page

2. Set **DHCP** to **ON** or **OFF**.
3. If DHCP is set to **OFF**, change any of the parameters (IP Address, Netmask and/or Gateway).
- 4 . Click **Set**.



After changing the IP number, reload the web page with the new IP address.
 After changing the Subnet mask you need to restart the **PA-240Z**.
 If DHCP is checked, reload the web page with the new IP address.

- 5 . Set the UDP and TCP port numbers and click **Set**.

Saving and Loading Settings

To save a configuration:

1. In the Navigation pane, click **Device Settings**. The Device Settings page appears ([Figure 18](#)).
2. Click **Save**. The following message appears:

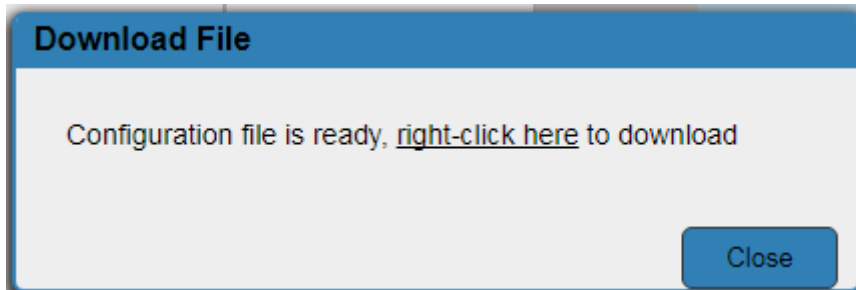

Figure 19: Device Settings Page – Download File Message

3. Right-click the link (**right-click here**) and click **Save link as**. The configuration is downloaded to your PC.

To load a configuration:

1. In the Navigation pane, click **Device Settings**. The Device Settings page appears ([Figure 18](#)).
2. Click **Load** and browse for the configuration file.

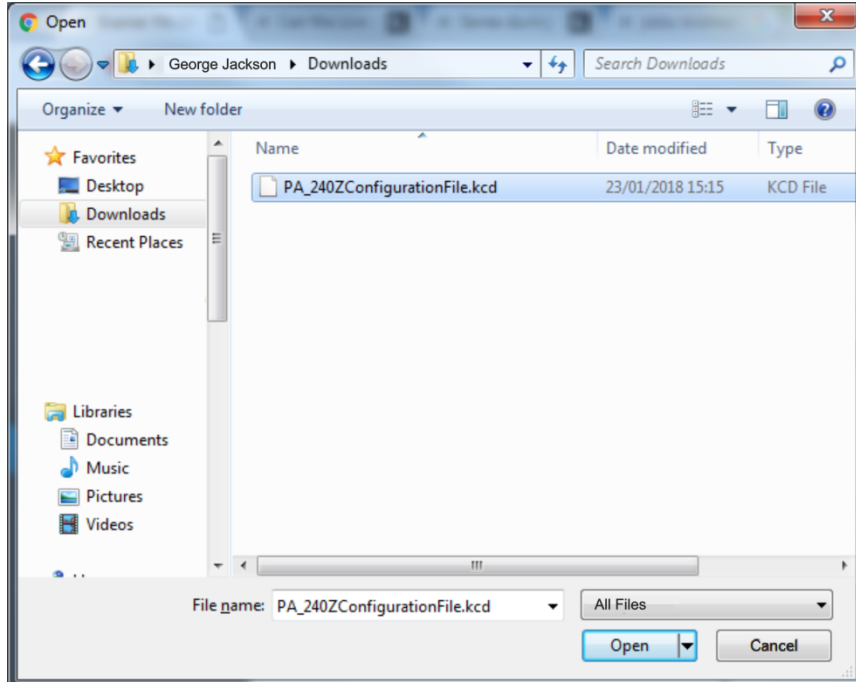

Figure 20: Device Settings Page – Selecting the Configuration File

3. Click **Open**. The configuration loads and the Load Configuration message is displayed. This process may take a few minutes to complete:

Once complete, the following message appears:

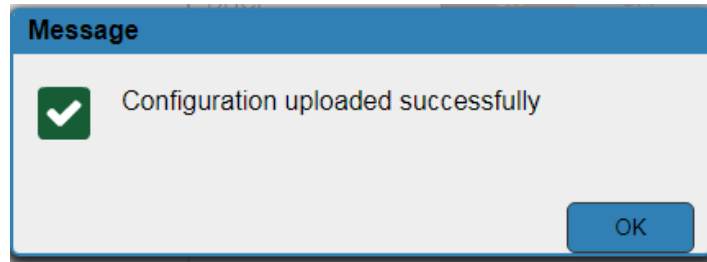

Figure 21: Device Settings Page – Configuration Uploaded

Performing a Factory Reset

To reset the device to its factory default values:

1. In the Navigation pane, click **Device Settings**. The Device Settings page appears ([Figure 18](#)).
2. Click **Factory reset**. The following window appears:

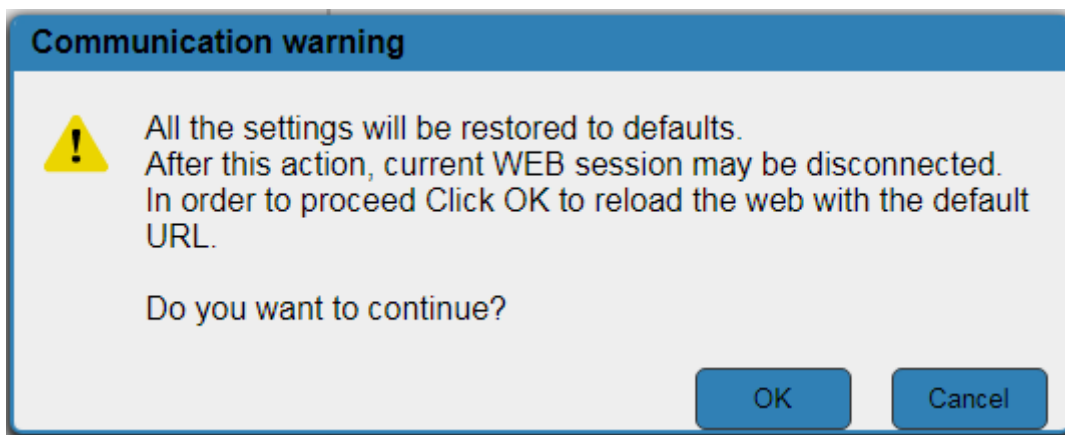

Figure 22: Device Settings Page – Factory Reset

3. Click **OK** to start factory reset and follow the instructions on-screen.

Managing Web Page Security

Use the Authentication page to set Web access permission.

To access Web pages without using the password:

1. In the Navigation pane, click **Security**. The Authentication page appears (Figure 18).

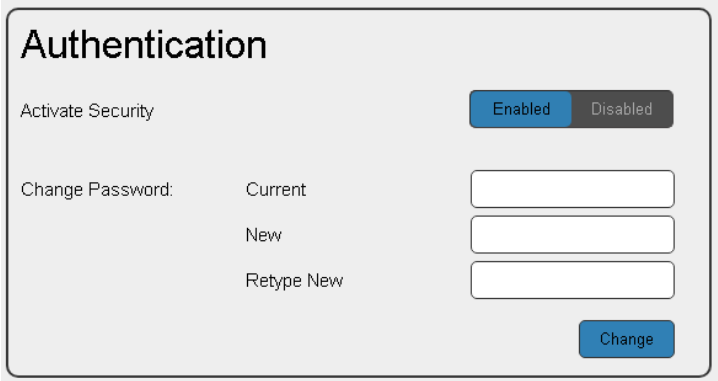

Figure 23: Authentication Page

2. Set **Activate Security** to **Disabled**. The following message appears:

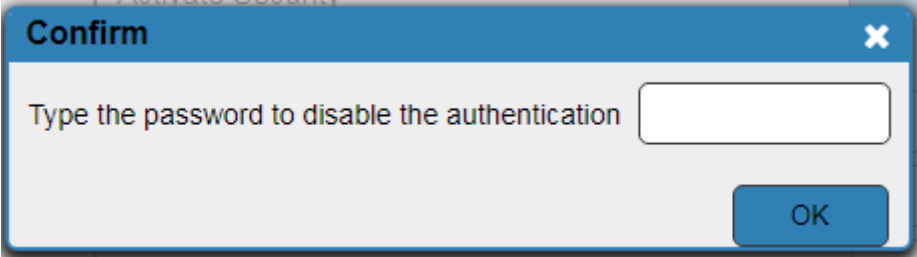

Figure 24: Password Settings Page – Deactivating the Security

3. Type the current password (Admin by-default) and click **OK**. The following message appears:

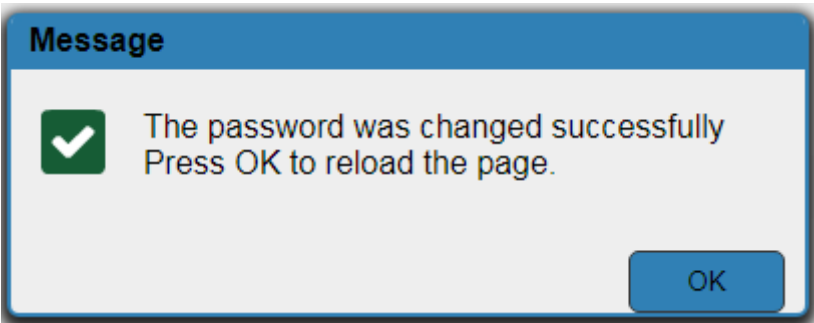



Figure 25: Password Settings Page – Password Disabling Message

4. Click **OK**. The Web page reloads and the web pages are unlocked  .

To access Web pages using the password:

1. In the Navigation pane, click **Security**. The Authentication page appears ([Figure 18](#)).

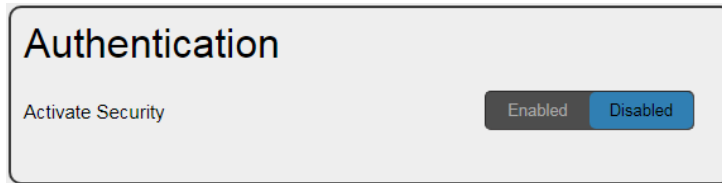

Figure 26: Password Settings Page – Security Deactivated

2. Set **Activate Security** to **Enabled** for Web page password protection. The following message appears:

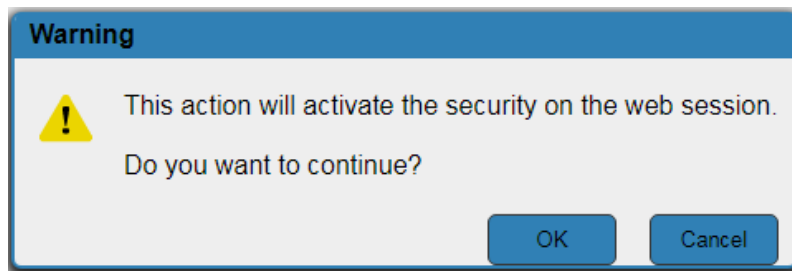

Figure 27: Password Settings Page – Security Activation Message

3. Click **OK**.
The connection is interrupted, and authentication is required to access web pages.

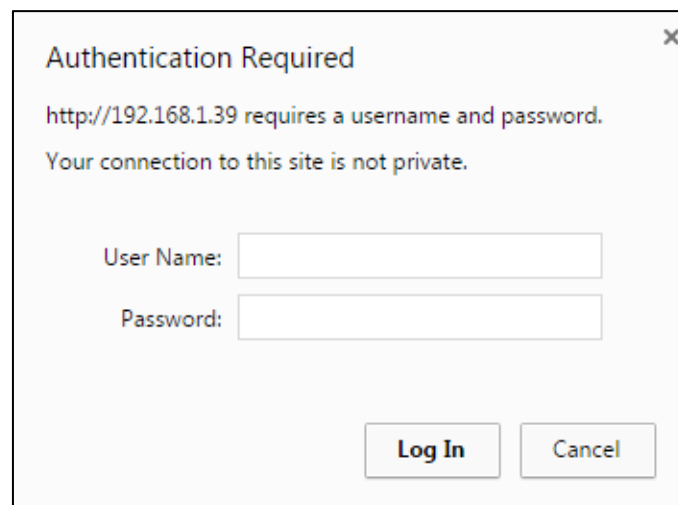

Figure 28: Password Settings Page – Security Log In

- 4. Type the User Name (Admin, by default) and Password (Admin, by default).
5. Click **Log In**.
 6. Select **Security** from the Navigation pane.

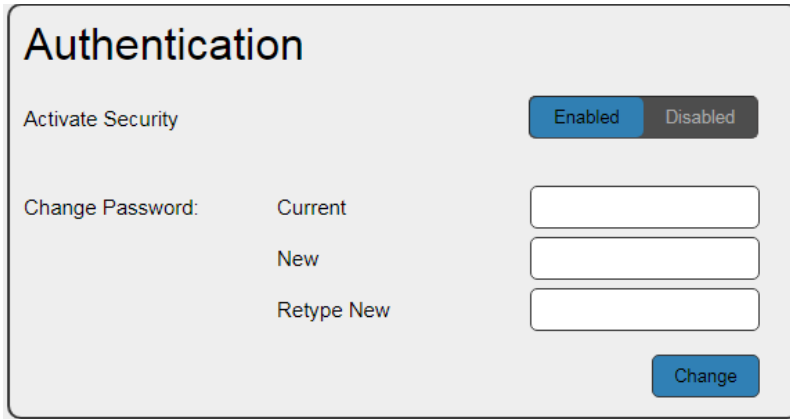

Figure 29: Password Settings Page – Changing the Authentication Password

7. Type the new authentication password twice in both **New** and **Retype New** text boxes.

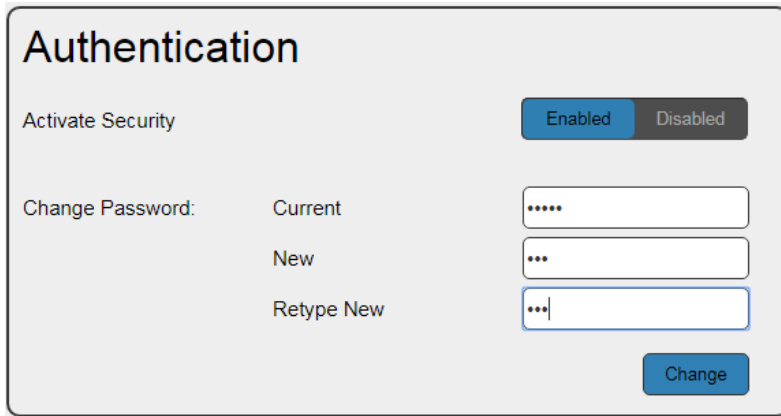

Figure 30: Password Settings Page – Entering the Admin Password

8. Click **Change**. The following message appears:

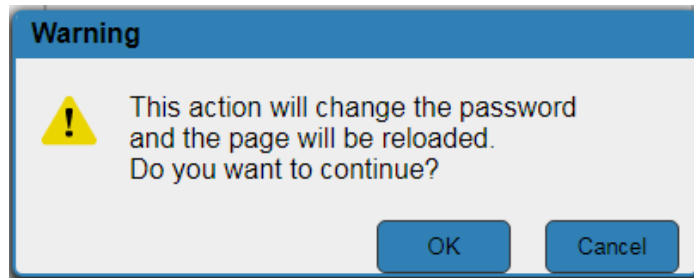

Figure 31: Password Settings Page – Password Warning

9. Click **OK**. The following message appears.

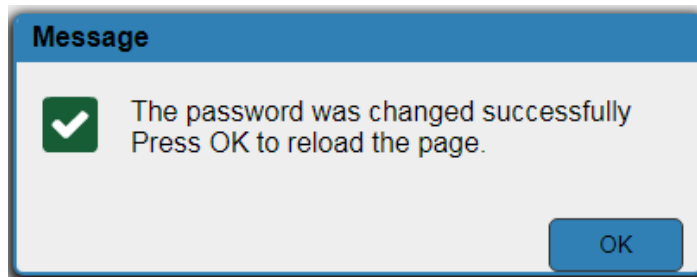



Figure 32: Password Settings Page – Password Change Message

10. Click **OK**.

The web pages are locked  .

Viewing the About Page

The About page lets you view the web page version and Kramer Electronics Ltd details.

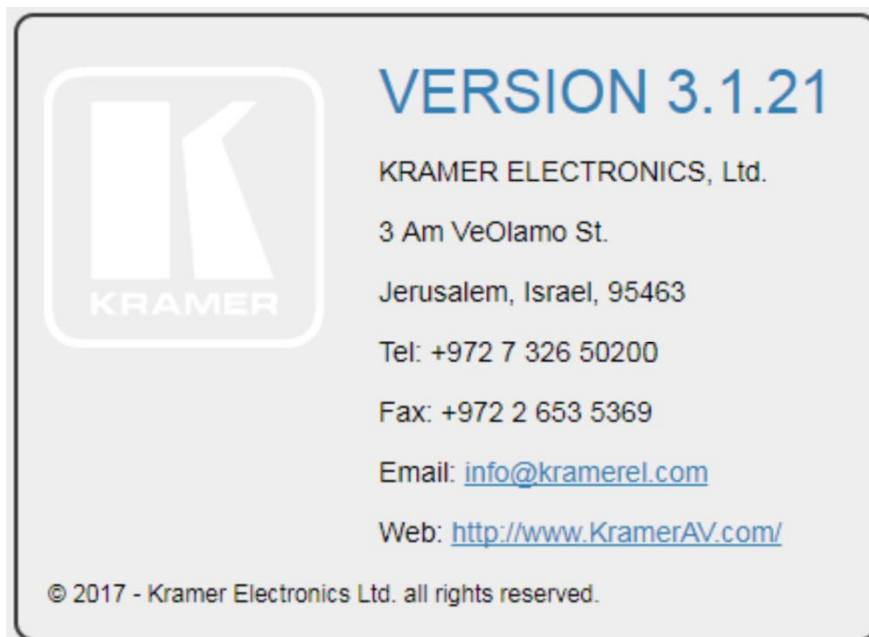

Figure 33: About Page

Technical Specifications

Input	1 Unbalanced Stereo Audio	On a 3.5mm mini jack
	1 Balanced Stereo Audio	On a 5-pin terminal block (up to +4dBu/10k Ω)
Outputs	1 Balanced Stereo Line Level	On a 5-pin terminal block connector
	1 Stereo or 1 Mono Speaker	On a 4-pin large terminal block
Input Sensitivity		Full power @ 0.3V (-10dBV)
Amplifier	Class	D
	Output Power:	PA-120Z: 2 x 60W @ 4 Ω or 8 Ω 1 x 120W @ 70V or 100V
		PA-240Z: 2 x 120W @ 4 Ω or 8 Ω 1 x 240W @ 70V or 100V
	Maximum Voltage Gain:	26dB SE / 32dB BTL
	Dynamic Range	119dB
	Frequency Response	20Hz to 20kHz @ +/-1dB
	S/N Ratio:	>80dB - 10dBV, 20 Hz - 20 kHz
	Audio THD + Noise:	<0.003% @ 1kHz @ 1W
	Audio 2nd Harmonic:	<0.08% @ 75W @ 4 Ω 6.67kHz
Controls		Master output volume attenuator, IP and RS-232
Power	Consumption	PA-120Z: 195VA PA-240Z: 265VA
	Source	PA-120Z: Universal mains operational voltage 85VAC - 265VAC PA-240Z: Universal mains operational voltage 85VAC - 265VAC (full power at 120V – 230V)
Total System Efficiency		PA-120Z: 89%
		PA-240Z: 90%
Environmental Conditions	Operating Temperature	0° to +40°C (32° to 104°F)
	Storage Temperature	-40° to +70°C (-40° to 158°F)
	Humidity	10% to 90%, RHL non-condensing
Regulatory Compliance	Safety	CE, UL
	Environmental	RoHs, WEEE
Enclosure	Size	1/2 19" 1U
	Type	Aluminum
	Cooling	Fan Ventilation
General	Net Dimensions	21.5cm x 16.3cm x 4.4cm (8.5" x 6.4" x 1.7")
	Shipping Dimensions	40.5cm x 29.7cm x 9cm (16" x 11.7" x 3.5")
	Net Weight	0.9kg (2lbs) approx.
	Shipping Weight	1.5kg (3.3lbs) approx.
Accessories	Included	power cord
	Optional	RK-1 rack adapter
Specifications are subject to change without notice at www.kramerav.com		

Default Communication Parameters

RS-232	
Protocol 3000	
Baud Rate:	115,200
Data Bits:	8
Stop Bits:	1
Parity:	None
Change the volume of input 2 to -10 DB	#X-AUD-LVL 1,2,-10
TCP/IP Parameters	
IP Address:	192.168.1.39
Subnet mask:	255.255.000.000
Default gateway:	192.168.0.1
Maximum UDP Connections:	Unlimited
Maximum TCP Connections:	Unlimited
UDP Port #:	50000
TCP Port #:	5000
Default Username / Password:	Admin / Admin
Full Factory Reset	
Protocol 3000	Excluding ETH: use "#FACTORY" command and use "#RESET" to restore the factory default values.

Protocol 3000

The **PA-240Z 240W Power Amplifier** can be operated using the Kramer Protocol 3000 serial commands. The command framing varies according to how you interface with the **PA-240Z**.

Generally, a basic video input switching command that routes a layer 1 video signal to HDMI out 1 from HDMI input 2 (ROUTE 1, 1, 2), is entered as follows:

- Terminal communication software, such as Hercules:

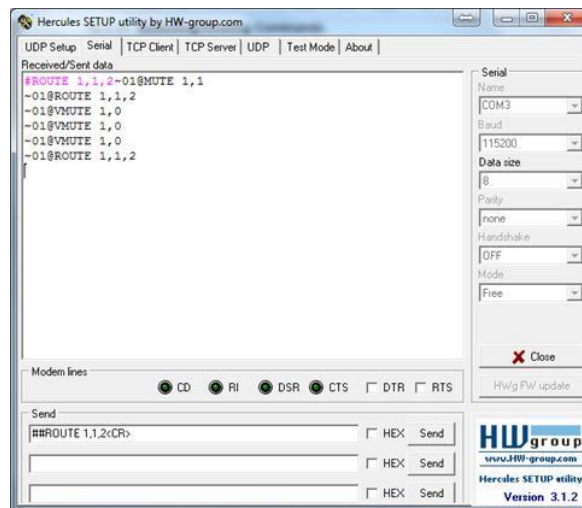

The framing of the command varies according to the terminal communication software.

- K-Touch Builder (Kramer software):



- K-Config (Kramer configuration software):



All the examples provided in this section are based on using the K-Config software.

You can enter commands directly using terminal communication software (e.g., Hercules) by connecting a PC to the serial or Ethernet port, depending on your device. To enter `CR` press the Enter key (`LF` is also sent but is ignored by the command parser).

Commands sent from various non-Kramer controllers (e.g., Crestron) may require special coding for some characters (such as, `/X#`). For more information, refer to your controller's documentation.

For more information about Protocol 3000 commands, see:

- [Understanding Protocol 3000](#) on page [30](#).
- [Kramer Protocol 3000 Syntax](#) on page [31](#).
- [Protocol 3000 Commands](#) on page [32](#).

Understanding Protocol 3000

Protocol 3000 commands are structured according to the following:

- **Command** – A sequence of ASCII letters (A-Z, a-z and -). A command and its parameters must be separated by at least one space.
- **Parameters** – A sequence of alphanumeric ASCII characters (0-9, A-Z, a-z and some special characters for specific commands). Parameters are separated by commas.
- **Message string** – Every command entered as part of a message string begins with a message starting character and ends with a message closing character.



A string can contain more than one command. Commands are separated by a pipe (|) character.

- **Message starting character:**
 - # – For host command/query
 - ~ – For device response
- **Device address** – K-NET Device ID followed by @ (optional, K-NET only)
- **Query sign** – ? follows some commands to define a query request
- **Message closing character:**
 - CR – Carriage return for host messages (ASCII 13)
 - CR LF – Carriage return for device messages (ASCII 13) and line-feed (ASCII 10)
- **Command chain separator character** – Multiple commands can be chained in the same string. Each command is delimited by a pipe character (|). When chaining commands, enter the message starting character and the message closing character only at the beginning and end of the string.



Spaces between parameters or command terms are ignored. Commands in the string do not execute until the closing character is entered. A separate response is sent for every command in the chain.

Kramer Protocol 3000 Syntax

The Kramer Protocol 3000 syntax uses the following delimiters:

- **CR** = Carriage return (ASCII 13 = 0x0D)
- **LF** = Line feed (ASCII 10 = 0x0A)
- **SP** = Space (ASCII 32 = 0x20)

Some commands have short name syntax in addition to long name syntax to enable faster typing. The response is always in long syntax.

The Protocol 3000 syntax is in the following format:

- **Host Message Format:**

Start	Address (optional)	Body	Delimiter
#	<i>Device_id@</i>	Message	CR

- **Simple Command** – Command string with only one command without addressing:

Start	Body	Delimiter
#	Command SP <i>Parameter_1,Parameter_2,...</i>	CR

- **Command String** – Formal syntax with command concatenation and addressing:

Start	Address	Body	Delimiter
#	<i>Device_id@</i>	Command_1 <i>Parameter1_1,Parameter1_2,...</i> Command_2 <i>Parameter2_1,Parameter2_2,...</i> Command_3 <i>Parameter3_1,Parameter3_2,...</i> ...	CR

- **Device Message Format:**

Start	Address (optional)	Body	Delimiter
~	<i>Device_id@</i>	Message	CR LF

- **Device Long Response** – Echoing command:

Start	Address (optional)	Body	Delimiter
~	<i>Device_id@</i>	Command SP [<i>Param1 ,Param2 ...</i>] result	CR LF

Protocol 3000 Commands

This section includes the following commands:

- [System Commands](#) on page [32](#).
- [Audio Commands](#) on page [36](#).
- [Communication Commands](#) on page [44](#).

System Commands

Command	Description
#	Protocol handshaking (system mandatory)
BUILD-DATE	Get device build date (system mandatory)
FACTORY	Reset to factory default configuration
HELP	Get command list (system mandatory)
MODEL	Get device model (system mandatory)
PROT-VER	Get device protocol version (system mandatory)
RESET	Reset device (system mandatory)
SN	Get device serial number (system mandatory)
NAME	Set/get machine (DNS) name (system – Ethernet)

#

Functions		Permission	Transparency
Set:	#	End User	Public
Get:	-	-	-
Description		Syntax	
Set:	Protocol handshaking	# <input type="text"/>	
Get:	-	-	
Response			
~nn@SPOKCR LF			
Notes			
Validates the Protocol 3000 connection and gets the machine number Step-in master products use this command to identify the availability of a device			
K-Config Example			
"#", 0x0D			

BUILD-DATE

Functions		Permission	Transparency
Set:	-	-	-
Get:	BUILD-DATE?	End User	Public
Description		Syntax	
Set:	-	-	
Get:	Get device build date	# BUILD-DATE? <code>[CR]</code>	
Response			
~ <code>[nn]</code> @ BUILD-DATE <code>[SP]</code> date <code>[SP]</code> time <code>[CR LF]</code>			
Parameters			
date – Format: YYYY/MM/DD where YYYY = Year, MM = Month, DD = Day			
time – Format: hh:mm:ss where hh = hours, mm = minutes, ss = seconds			
K-Config Example			
"# BUILD-DATE? ",0x0D			

FACTORY

Functions		Permission	Transparency
Set:	FACTORY	End User	Public
Get:	-	-	-
Description		Syntax	
Set:	Reset device to factory default configuration	# FACTORY <code>[CR]</code>	
Get:	-	-	
Response			
~ <code>[nn]</code> @ FACTORY <code>[SP]</code> OK <code>[CR LF]</code>			
Notes			
This command deletes all user data from the device. The deletion can take some time. Your device may require powering off and powering on for the changes to take effect.			
K-Config Example			
"# FACTORY ",0x0D			

HELP

Functions		Permission	Transparency
Set:	-	-	-
Get:	HELP	End User	Public
Description		Syntax	
Set:	-	-	
Get:	Get command list or help for specific command	1. # HELP <code>[CR]</code> 2. # HELP <code>[SP]</code> COMMAND_NAME <code>[CR]</code>	
Response			
1. Multi-line: ~ <code>[nn]</code> @Device available protocol 3000 commands: <code>[CR LF]</code> command, <code>[SP]</code> command... <code>[CR LF]</code>			
2. Multi-line: ~ <code>[nn]</code> @ HELP <code>[SP]</code> command: <code>[CR LF]</code> description <code>[CR LF]</code> USAGE:usage <code>[CR LF]</code>			
Parameters			
COMMAND_NAME – name of a specific command			
Notes			
To get help for a specific command use: HELP <code>[SP]</code> COMMAND_NAME <code>[CR LF]</code>			
K-Config Example			
"# HELP ",0x0D			

MODEL

Functions		Permission	Transparency
Set:	-	-	-
Get:	MODEL?	End User	Public
Description		Syntax	
Set:	-	-	
Get:	Get device model	# MODEL? <code>CR</code>	
Response			
~ <code>nn</code> @ MODEL <code>SP</code> <code>model_name</code> <code>CR LF</code>			
Parameters			
model_name – String of up to 16 printable ASCII chars			
Notes			
This command identifies equipment connected to Step-in master products and notifies of identity changes to the connected equipment. The Matrix saves this data in memory to answer REMOTE-INFO requests			
K-Config Example			
“# MODEL? ”,0x0D			

PROT-VER

Functions		Permission	Transparency
Set:	-	-	-
Get:	PROT-VER?	End User	Public
Description		Syntax	
Set:	-	-	
Get:	Get device protocol version	# PROT-VER? <code>CR</code>	
Response			
~ <code>nn</code> @ PROT-VER <code>SP</code> 3000 : version <code>CR LF</code>			
Parameters			
version - XX.XX where X is a decimal digit			
K-Config Example			
“# PROT-VER? ”,0x0D			

RESET

Functions		Permission	Transparency
Set:	RESET	Administrator	Public
Get:	-	-	-
Description		Syntax	
Set:	Reset device	# RESET <code>CR</code>	
Get:	-	-	
Response			
~ <code>nn</code> @ RESET <code>SP</code> OK <code>CR LF</code>			
Notes			
To avoid locking the port due to a USB bug in Windows, disconnect USB connections immediately after running this command. If the port was locked, disconnect and reconnect the cable to reopen the port.			
K-Config Example			
“# RESET ”,0x0D			

SN

Functions		Permission	Transparency
Set:	-	-	-
Get:	SN?	End User	Public
Description		Syntax	
Set:	-	-	
Get:	Get device serial number	# SN? <input type="checkbox"/> CR	
Response			
~nn@ SN <input type="checkbox"/> SP serial_number <input type="checkbox"/> CR LF			
Parameters			
serial_number – 14 decimal digits, factory assigned			
K-Config Example			
"#SN?",0x0D			

NAME

Functions		Permission	Transparency
Set:	NAME	Administrator	Public
Get:	NAME?	End User	Public
Description		Syntax	
Set:	Set machine (DNS) name	# NAME <input type="checkbox"/> SP machine_name <input type="checkbox"/> CR	
Get:	Get machine (DNS) name	# NAME? <input type="checkbox"/> CR	
Response			
Set: ~nn@ NAME <input type="checkbox"/> SP machine_name <input type="checkbox"/> CR LF			
Get: ~nn@ NAME? <input type="checkbox"/> SP machine_name <input type="checkbox"/> CR LF			
Parameters			
machine_name – String of up to 15 alpha-numeric characters (can include hyphens but not at the beginning or end)			
Notes			
The machine name is not the same as the model name. The machine name is used to identify a specific machine or a network in use (with DNS feature on).			
K-Config Example			
Set the DNS name of the device to "room-442": "#NAME room-442",0x0D			

Audio Commands

Command	Description
AUD-CH-LINK	Set/get link between speaker configuration and line level output state
AUD-CLIP?	Get clipping status
AUD-FILTER	Set/get filter/state
AUD-HI-Z	Get High Z status
AUD-IN-CONF	Set/get threshold and time
AUD-LVL	Set/get audio level in specific amplifier stage
AUD-MIX	Set/get mixer level
AUD-MONO-MODE	Set/get output select state when audio in HI-Z mode only
AUD-SIGNAL?	Get audio input signal status
AUD-STANDBY	Set/get standby mode/state
BALANCE	Set/get balance level
EQ-FREQ	Set/get equalizer center
EQ-LVL	Set/get equalization level
EQ-Q	Set/get Q level
MUTE	Set/get audio mute

AUD-CH-LINK

Functions	Permission	Transparency
Set: AUD-CH-LINK	End User	Public
Get: AUD-CH-LINK?	End User	Public
Description	Syntax	
Set: Set link between speaker configuration and line level output	#AUD-CH-LINK _[SP] Ch1,Ch2,LinkState _[CR]	
Get: Get the configuration link state	#AUD-CH-LINK? _[SP] Ch1 _[CR]	
Response		
~nn@AUD-CH-LINK _[SP] Ch1,Ch2,LinkState _[CR] LF		
Parameters		
Ch1 – 1 (Speaker Output)		
Ch2 – 2 (Line Level Output)		
LinkState – 1 (enable), 0 (disable)		
Notes		
Response if no link – AUD-CH-LINK 1,1,0		
Response if link – AUD-CH-LINK 1,2,1		
K-Config Example		
Set a link between the speaker output configuration and the line level output configuration: “#AUD-CH-LINK 1,2,1”,0x0D		

AUD-CLIP?

Functions		Permission	Transparency
Set:	-	-	-
Get	AUD-CLIP?	End User	Public
Description		Syntax	
Set:	-	-	
Get:	Get clipping status	#AUD-CLIP? _[SP] Channel _[CR]	
Response			
~nn@AUD-CLIP? _[SP] Channel,ClipStatus _[CR LF]			
Parameters			
Channel – 1 (Speaker Output), 2 (Line Level Output)			
ClipStatus – 1 (Clipping detected), 0 (Clipping not detected)			
K-Config Example			
Get the speaker output channel clipping status: "#AUD-CLIP? 1",0x0D			

AUD-FILTER

Functions		Permission	Transparency
Set:	AUD-FILTER	End User	Public
Get	AUD-FILTER?	End User	Public
Description		Syntax	
Set:	Set filter	#AUD-FILTER _[SP] Channel,FilterType,Freq,State _[CR]	
Get:	Get filter state	#AUD-FILTER? _[SP] Channel _[CR]	
Response			
~nn@AUD-FILTER _[SP] Channel,FilterType,Freq,State _[CR LF]			
Parameters			
Channel – 1 (Speaker Output), 2 (Line Level Output)			
FilterType – Filter type: 0 (High pass filter)			
Freq – Filter frequency: 0 (T: 10kHz, M: 500Hz, B: 60Hz), 1 (T: 12.5kHz, M: 1kHz, B: 80Hz), 2 (T: 15kHz, M: 1.5kHz, B: 500Hz), 3 (T: 17.5kHz, M: 2.5kHz, B: 200Hz)			
State – 1 (On), 0 (Off)			
Notes			
T=Treble, M=Middle, B=Bass			
K-Config Example			
Set the audio filter on the speaker output on to high-pass filter, T: 10kHz, M: 500Hz, B: 60Hz: "#AUD-FILTER 1,0,0,1",0x0D			

AUD-HI-Z

Functions		Permission	Transparency
Set:	AUD-HI-Z	End User	Public
Get	AUD-HI-Z?	End User	Public
Description		Syntax	
Set:	Set High Z state	#AUD-HI-Z _{CR} Channel _{SP} HiZState,HiZVolt _{CR}	
Get:	Get High Z status	#AUD-HI-Z? _{CR}	
Response			
~nn@AUD-HI-Z _{SP} Channel,HiZState,HiZVolt _{CR LF}			
Parameters			
Channel – 1 (Speaker Output), 2 (Line Level Output)			
HiZState – 1 (Hi-Z state high), 0 (Hi-Z state low)			
HiZVolt – Hi-Z volt level: 0 (70 Volt), 1 (100 Volt), 0xff (Ignore). Optional, active only in high state			
Notes			
Active only when state is high. Ignore everything else.			
K-Config Example			
Set the line level output to Hi-Z and 70V: "#AUD-HI-Z 2,1,0",0x0D			

AUD-IN-CONF

Functions		Permission	Transparency
Set:	AUD-IN-CONF	End User	Public
Get	AUD-IN-CONF?	End User	Public
Description		Syntax	
Set:	Set threshold and time to indicate when signal is presents or not	#AUD-IN-CONF _{SP} Channel,ThresholdDbLevel,TrigTimeDelay _{CR}	
Get:	Get threshold and time	#AUD-IN-CONF? _{SP} Channel _{CR}	
Response			
~nn@AUD-IN-CONF _{SP} Channel,ThresholdDbLevel,TrigTimeDelay _{CR LF}			
Parameters			
Channel – 1 (Speaker Output), 2 (Line Level Output)			
ThresholdDbLevel – input level indicating when a signal is not present, range -100 to 0dB			
TrigTimeDelay – 10 (fixed)			
K-Config Example			
Set the speaker output threshold level and time: "#AUD-IN-CONF 1,-50,10",0x0D			

AUD-LVL

Functions		Permission	Transparency
Set:	AUD-LVL	End User	Public
Get:	AUD-LVL?	End User	Public
Description		Syntax	
Set:	Set volume level	#AUD-LVL _{SP} stage,channel,volume,mutebehavior _{CR}	
Get:	Get volume level	#AUD-LVL? _{SP} stage,channel _{CR}	
Response			
~nn@AUD-LVL _{SP} stage,channel,volume _{CR LF}			
Parameters			
stage – 1 (For output processing) channel – 1 (Speaker Output), 2 (Line Level Output) volume – volume level -80db to 10dB mutebehavior – optional, 1 (changing the volume does not affect the mute state)			
K-Config Example			
Set the speaker output audio level to -50dB: "#AUD-LVL 1,1,-50",0x0D			

AUD-MIX

Functions		Permission	Transparency
Set:	AUD-MIX	End User	Public
Get:	AUD-MIX?	End User	Public
Description		Syntax	
Set:	Set mixer level	#AUD-MIX _{SP} channel,knob,level _{CR}	
Get:	Get mixer level	#AUD-MIX? _{SP} channel,knob _{CR}	
Response			
~nn@AUD-MIX _{SP} channel,knob,level _{CR LF}			
Parameters			
channel – 1 (Speaker Output), 2 (Line Level Output) knob – mixer knob number: 1 (Input 1), 2 (Input 2) level – mixer level: -80 to 10dB			
K-Config Example			
Set the input mixing level of input 2 on the speaker output to -48dB: "#AUD-MIX 1,2,-48",0x0D			

AUD-MONO-MODE

Functions		Permission	Transparency
Set:	AUD-MONO-MODE	End User	Public
Get	AUD-MONO-MODE?	End User	Public
Description		Syntax	
Set:	Set output select state when audio in HI-Z mode only	#AUD-MONO-MODE _{SP} MonoMode _{CR}	
Get:	Get output select state when audio in HI-Z mode only	#AUD-MONO-MODE? _{CR}	
Response			
~nn@AUD-MONO-MODE _{SP} MonoMode _{CR LF}			
Parameters			
MonoMode – The mono output mode: 0 (output is "stereo mix to mono" – both left and right mix to one channel), 1 (output is "left to mono" – duplicate left channel information to the right and play both)			
Notes			
These commands are active only when the state is HI-Z, otherwise an error is returned. To set, the MonoMode parameter must be used.			
K-Config Example			
Set the output to mix to mono: "#AUD-MONO-MODE 0",0x0D			

AUD-SIGNAL

Functions		Permission	Transparency
Set:	-	-	-
Get	AUD-SIGNAL?	End User	Public
Description		Syntax	
Set:	-	-	
Get:	Get audio input signal status	#AUD-SIGNAL? _{SP} inp_id _{CR}	
Response			
~nn@AUD-SIGNAL _{SP} inp_id,status _{CR LF}			
Parameters			
inp_id – input number: 1 (Input 1), 2 (Input 2) status – 0 (OFF, no signal), 1 (ON, signal present)			
Response Triggers			
After execution, response is sent to the com port from which the Get was received Response is sent to all com ports if audio status state was changed on any input			
K-Config Example			
get the status of input 1: "#AUD-SIGNAL? 1",0x0D			

AUD-STANDBY

Functions		Permission	Transparency
Set:	AUD-STANDBY	End User	Public
Get:	AUD-STANDBY?	End User	Public
Description		Syntax	
Set:	Set standby mode	#AUD-STANDBY _{SP} StandbyMode,TimeDelay _{CR}	
Get:	Get standby mode state	#AUD-STANDBY? _{CR}	
Response			
~nn@AUD-STANDBY _{SP} StandbyMode,TimeDelay _{CR LF}			
Parameters			
StandbyMode – 0 (Off), 1 (Delayed, auto mode), 2 (Standby mode)			
TimeDelay – 5, 10, or 15 (time delay [min] to standby mode)			
Notes			
Active only in auto mode			
K-Config Example			
Set the standby delay time to 10 minutes: “#AUD-STANDBY 1,10”,0x0D			

BALANCE

Functions		Permission	Transparency
Set:	BALANCE	End User	Public
Get:	BALANCE?	End User	Public
Description		Syntax	
Set:	Set balance level	#BALANCE _{SP} channel,balancelevel _{CR}	
Get:	Get balance level	#BALANCE? _{SP} channel _{CR}	
Response			
~nn@BALANCE _{SP} channel,balance_level _{CR LF}			
Parameters			
channel – 1 (Speaker output), 2 (Line level output)			
balancelevel – -15 to +15 (audio parameter in Kramer units, minus sign precedes negative values)			
++ (increase current value)			
-- (decrease current value)			
K-Config Example			
Set the speaker output balance to +12: “#BALANCE 1,12”,0x0D			

EQ-FREQ

Functions		Permission	Transparency
Set:	EQ-FREQ	End User	Public
Get	EQ-FREQ?	End User	Public
Description		Syntax	
Set:	Set equalizer frequency	#EQ-FREQ _[SP] Stage,Channel,EqType,EqFreq _[CR]	
Get:	Get equalizer frequency	#EQ-FREQ? _[SP] Stage,Channel,EqType _[CR]	
Response			
~nn@EQ-FREQ _[SP] Stage,Channel,EqType,EqFreq _[CR LF]			
Parameters			
Stage – 1 (Output) Channel – 1 (Speaker output), 2 (Line Level Output) EqType – 0 (Bass), 1 (Middle), 2 (Treble) EqFreq – 0 (T: 10kHz, M: 500Hz, B: 60Hz), 1 (T: 12.5kHz, M: 1kHz, B: 80Hz), 2 (T: 15kHz, M: 1.5kHz, B: 500Hz), 3 (T: 17.5kHz, M: 2.5kHz, B: 200Hz)			
Notes			
T=Treble, M=Middle, B=Bass			
K-Config Example			
Set speaker output equalizer frequency on the bass to 200Hz: “#EQ-FREQ 1,1,0,3”,0x0D			

EQ-LVL

Functions		Permission	Transparency
Set:	EQ-LVL	End User	Public
Get:	EQ-LVL?	End User	Public
Description		Syntax	
Set:	Set equalization level	#EQ-LVL _[SP] Stage,Channel,EqType,Level _[CR]	
Get :	Get equalization level	#EQ-LVL? _[SP] Stage,Channel,EqType _[CR]	
Response			
~nn@EQ-LVL _[SP] Stage,Channel,EqType,Level _[CR LF]			
Parameters			
Stage – 1 (Output processing) Channel – 1 (Speaker output), 2 (Line level output) EqType – 0 (Bass), 1 (Middle), 2 (Treble) Level –equalizer level			
K-Config Example			
Set Bass EQ level of the speaker output to 12: “#EQ-LVL 1,1,0,12”,0x0D			

EQ-Q

Functions		Permission	Transparency
Set:	EQ-Q	End User	Public
Get:	EQ-Q?	End User	Public
Description		Syntax	
Set:	Set Q level	#EQ-Q[SP]Channel,EqType,Q_level[CR]	
Get:	Get Q level	#EQ-Q?[SP]Channel,EqType[CR]	
Response			
~nn@EQ-Q[SP]Channel,EqType,Q_level[CR LF]			
Parameters			
Channel – 1 (Speaker output), 2 (Line level output) EqType – 0 (Bass), 1 (Middle), 2 (Treble) Q_level – 0 to 15 (Q level)			
K-Config Example			
Set the line level output treble Q level to 8: “#EQ-Q 2,8”,0x0D			

MUTE

Functions		Permission	Transparency
Set:	MUTE	End User	Public
Get:	MUTE?	End User	Public
Description		Syntax	
Set:	Set audio mute	#MUTE[SP]channel,mute_mode[CR]	
Get:	Get audio mute	#MUTE?[SP]channel[CR]	
Response			
~nn@MUTE[SP]channel,mute_mode[CR LF]			
Parameters			
channel – 1 (Speaker output), 2 (Line level output) mute_mode – 0 (Off), 1 (On)			
K-Config Example			
Set speaker output to mute: “#MUTE 1,1”,0x0D			

Communication Commands

Command	Description
ETH-PORT	Set/get Ethernet port protocol
NET-DHCP	Set/get DHCP mode
NET-GATE	Set/get gateway IP
NET-IP	Set/get IP address
NET-MAC	Get MAC address
NET-MASK	Set/get subnet mask

ETH-PORT

Functions		Permission	Transparency
Set:	ETH-PORT	Administrator	Public
Get:	ETH-PORT?	End User	Public
Description		Syntax	
Set:	Set Ethernet port protocol	# ETH-PORT [SP] portType , ETHPort [CR]	
Get:	Get Ethernet port protocol	# ETH-PORT? [SP] portType [CR]	
Response			
~ nn @ ETH-PORT [SP] portType , ETHPort [CR LF]			
Parameters			
portType – 0 (TCP), 1 (UDP)			
ETHPort – 0-65534 (TCP / UDP port number)			
Notes			
If the port number you enter is already in use, an error is returned. The port number must be within the following range: 2000-(2 ¹⁶ -1). UDP port 50001 and TCP port 5001 are reserved for internal use.			
K-Config Example			
Set the Ethernet port protocol for TCP to port 12457: `#ETH-PORT 0,12457",0x0D`			

NET-DHCP

Functions		Permission	Transparency
Set:	NET-DHCP	Administrator	Public
Get:	NET-DHCP?	End User	Public
Description		Syntax	
Set:	Set DHCP mode	# NET-DHCP [SP]mode[CR]	
Get:	Get DHCP mode	# NET-DHCP? [CR]	
Response			
~nn@ NET-DHCP [SP]mode[CR LF]			
Parameters			
mode – 0 (do not use DHCP. Use the IP address set by the factory or the NET-IP command), 1 (try to use DHCP. If unavailable, use the IP address set by the factory or the NET-IP command)			
Notes			
Connecting Ethernet to devices with DHCP may take more time in some networks. To connect with a randomly assigned IP by DHCP, specify the device DNS name (if available) using the NAME command. You can also get an assigned IP by direct connection to USB or RS-232 protocol port if available. Consult your network administrator for correct settings.			
K-Config Example			
Enable DHCP mode, if available: `#NET-DHCP 1`, 0x0D			

NET-GATE

Functions		Permission	Transparency
Set:	NET-GATE	Administrator	Public
Get:	NET-GATE?	End User	Public
Description		Syntax	
Set:	Set gateway IP	# NET-GATE [SP]ip_address[CR]	
Get:	Get gateway IP	# NET-GATE? [CR]	
Response			
~nn@ NET-GATE [SP]ip_address[CR LF]			
Parameters			
ip_address – gateway IP address, in the following format: xxx.xxx.xxx.xxx			
Notes			
A network gateway connects the device via another network, possibly over the Internet. Be careful of security problems. Consult your network administrator for correct settings.			
K-Config Example			
Set the gateway IP address to 192.168.0.1: `#NET-GATE 192.168.000.001`, 0x0D			

NET-IP

Functions		Permission	Transparency
Set:	NET-IP	Administrator	Public
Get:	NET-IP?	End User	Public
Description		Syntax	
Set:	Set IP address	# NET-IP [SP] ip_address [CR]	
Get:	Get IP address	# NET-IP? [CR]	
Response			
~nn@ NET-IP [SP] ip_address [CR LF]			
Parameters			
ip_address – IP address, in the following format: xxx.xxx.xxx.xxx			
Notes			
Consult your network administrator for correct settings.			
K-Config Example			
Set the IP address to 192.168.1.39: "#NET-IP 192.168.001.039", 0x0D			

NET-MAC

Functions		Permission	Transparency
Set:	-	-	-
Get:	NET-MAC?	End User	Public
Description		Syntax	
Set:	-	-	
Get:	Get MAC address	# NET-MAC? [CR]	
Response			
~nn@ NET-MAC [SP] mac_address [CR LF]			
Parameters			
mac_address – unique MAC address. Format: XX-XX-XX-XX-XX-XX where x is hex digit			
K-Config Example			
"#NET-MAC?", 0x0D			

NET-MASK

Functions		Permission	Transparency
Set:	NET-MASK	Administrator	Public
Get:	NET-MASK?	End User	Public
Description		Syntax	
Set:	Set subnet mask	# NET-MASK [SP] net_mask [CR]	
Get:	Get subnet mask	# NET-MASK? [CR]	
Response			
~nn@ NET-MASK [SP] net_mask [CR LF]			
Parameters			
net_mask – format: xxx.xxx.xxx.xxx			
Response Triggers			
The subnet mask limits the Ethernet connection within the local network Consult your network administrator for correct settings			
K-Config Example			
Set the subnet mask to 255.255.0.0: "#NET-MASK 255.255.000.000", 0x0D			

The warranty obligations of Kramer Electronics Inc. ("Kramer Electronics") for this product are limited to the terms set forth below:

What is Covered

This limited warranty covers defects in materials and workmanship in this product.

What is Not Covered

This limited warranty does not cover any damage, deterioration or malfunction resulting from any alteration, modification, improper or unreasonable use or maintenance, misuse, abuse, accident, neglect, exposure to excess moisture, fire, improper packing and shipping (such claims must be presented to the carrier), lightning, power surges, or other acts of nature. This limited warranty does not cover any damage, deterioration or malfunction resulting from the installation or removal of this product from any installation, any unauthorized tampering with this product, any repairs attempted by anyone unauthorized by Kramer Electronics to make such repairs, or any other cause which does not relate directly to a defect in materials and/or workmanship of this product. This limited warranty does not cover cartons, equipment enclosures, cables or accessories used in conjunction with this product.

Without limiting any other exclusion herein, Kramer Electronics does not warrant that the product covered hereby, including, without limitation, the technology and/or integrated circuit(s) included in the product, will not become obsolete or that such items are or will remain compatible with any other product or technology with which the product may be used.

How Long this Coverage Lasts

The standard limited warranty for Kramer products is seven (7) years from the date of original purchase, with the following exceptions:

1. All Kramer VIA hardware products are covered by a standard three (3) year warranty for the VIA hardware and a standard three (3) year warranty for firmware and software updates.
2. All Kramer fiber optic cables, adapter-size fiber optic extenders, active cables, cable retractors, all Kramer speakers and Kramer touch panels are covered by a standard one (1) year warranty.
3. All Kramer Cobra products, all Kramer Calibre products, all Kramer Minicom digital signage products, all HighSecLabs products, all streaming, and all wireless products are covered by a standard three (3) year warranty.
4. All Sierra Video MultiViewers are covered by a standard five (5) year warranty.
5. Sierra switchers & control panels are covered by a standard seven (7) year warranty (excluding power supplies and fans that are covered for three (3) years).
6. K-Touch software is covered by a standard one (1) year warranty for software updates.
7. All Kramer passive cables are covered by a ten (10) year warranty.

Who is Covered

Only the original purchaser of this product is covered under this limited warranty. This limited warranty is not transferable to subsequent purchasers or owners of this product.

What Kramer Electronics Will Do

Kramer Electronics will, at its sole option, provide one of the following three remedies to whatever extent it shall deem necessary to satisfy a proper claim under this limited warranty:

1. Elect to repair or facilitate the repair of any defective parts within a reasonable period of time, free of any charge for the necessary parts and labor to complete the repair and restore this product to its proper operating condition. Kramer Electronics will also pay the shipping costs necessary to return this product once the repair is complete.
2. Replace this product with a direct replacement or with a similar product deemed by Kramer Electronics to perform substantially the same function as the original product.
3. Issue a refund of the original purchase price less depreciation to be determined based on the age of the product at the time remedy is sought under this limited warranty.

What Kramer Electronics Will Not Do Under This Limited Warranty

If this product is returned to Kramer Electronics or the authorized dealer from which it was purchased or any other party authorized to repair Kramer Electronics products, this product must be insured during shipment, with the insurance and shipping charges prepaid by you. If this product is returned uninsured, you assume all risks of loss or damage during shipment. Kramer Electronics will not be responsible for any costs related to the removal or re-installation of this product from or into any installation. Kramer Electronics will not be responsible for any costs related to any setting up this product, any adjustment of user controls or any programming required for a specific installation of this product.

How to Obtain a Remedy Under This Limited Warranty

To obtain a remedy under this limited warranty, you must contact either the authorized Kramer Electronics reseller from whom you purchased this product or the Kramer Electronics office nearest you. For a list of authorized Kramer Electronics resellers and/or Kramer Electronics authorized service providers, visit our web site at www.kramerav.com or contact the Kramer Electronics office nearest you.

In order to pursue any remedy under this limited warranty, you must possess an original, dated receipt as proof of purchase from an authorized Kramer Electronics reseller. If this product is returned under this limited warranty, a return authorization number, obtained from Kramer Electronics, will be required (RMA number). You may also be directed to an authorized reseller or a person authorized by Kramer Electronics to repair the product.

If it is decided that this product should be returned directly to Kramer Electronics, this product should be properly packed, preferably in the original carton, for shipping. Cartons not bearing a return authorization number will be refused.

Limitation of Liability

THE MAXIMUM LIABILITY OF KRAMER ELECTRONICS UNDER THIS LIMITED WARRANTY SHALL NOT EXCEED THE ACTUAL PURCHASE PRICE PAID FOR THE PRODUCT. TO THE MAXIMUM EXTENT PERMITTED BY LAW, KRAMER ELECTRONICS IS NOT RESPONSIBLE FOR DIRECT, SPECIAL, INCIDENTAL OR CONSEQUENTIAL DAMAGES RESULTING FROM ANY BREACH OF WARRANTY OR CONDITION, OR UNDER ANY OTHER LEGAL THEORY. Some countries, districts or states do not allow the exclusion or limitation of relief, special, incidental, consequential or indirect damages, or the limitation of liability to specified amounts, so the above limitations or exclusions may not apply to you.

Exclusive Remedy

TO THE MAXIMUM EXTENT PERMITTED BY LAW, THIS LIMITED WARRANTY AND THE REMEDIES SET FORTH ABOVE ARE EXCLUSIVE AND IN LIEU OF ALL OTHER WARRANTIES, REMEDIES AND CONDITIONS, WHETHER ORAL OR WRITTEN, EXPRESS OR IMPLIED. TO THE MAXIMUM EXTENT PERMITTED BY LAW, KRAMER ELECTRONICS SPECIFICALLY DISCLAIMS ANY AND ALL IMPLIED WARRANTIES, INCLUDING, WITHOUT LIMITATION, WARRANTIES OF MERCHANTABILITY AND FITNESS FOR A PARTICULAR PURPOSE. IF KRAMER ELECTRONICS CANNOT LAWFULLY DISCLAIM OR EXCLUDE IMPLIED WARRANTIES UNDER APPLICABLE LAW, THEN ALL IMPLIED WARRANTIES COVERING THIS PRODUCT, INCLUDING WARRANTIES OF MERCHANTABILITY AND FITNESS FOR A PARTICULAR PURPOSE, SHALL APPLY TO THIS PRODUCT AS PROVIDED UNDER APPLICABLE LAW. IF ANY PRODUCT TO WHICH THIS LIMITED WARRANTY APPLIES IS A "CONSUMER PRODUCT" UNDER THE MAGNUSON-MOSS WARRANTY ACT (15 U.S.C.A. §2301, ET SEQ.) OR OTHER APPLICABLE LAW, THE FOREGOING DISCLAIMER OF IMPLIED WARRANTIES SHALL NOT APPLY TO YOU, AND ALL IMPLIED WARRANTIES ON THIS PRODUCT, INCLUDING WARRANTIES OF MERCHANTABILITY AND FITNESS FOR THE PARTICULAR PURPOSE, SHALL APPLY AS PROVIDED UNDER APPLICABLE LAW.

Other Conditions

This limited warranty gives you specific legal rights, and you may have other rights which vary from country to country or state to state.

This limited warranty is void if (i) the label bearing the serial number of this product has been removed or defaced, (ii) the product is not distributed by Kramer Electronics or (iii) this product is not purchased from an authorized Kramer Electronics reseller. If you are unsure whether a reseller is an authorized Kramer Electronics reseller, visit our web site at www.kramerav.com or contact a Kramer Electronics office from the list at the end of this document.

Your rights under this limited warranty are not diminished if you do not complete and return the product registration form or complete and submit the online product registration form. Kramer Electronics thanks you for purchasing a Kramer Electronics product. We hope it will give you years of satisfaction.



P/N:



2900-300802

Rev:



4



SAFETY WARNING

Disconnect the unit from the power supply before opening and servicing

For the latest information on our products and a list of Kramer distributors, visit our Web site where updates to this user manual may be found.

We welcome your questions, comments, and feedback.