



MUSIC SYNTHESIZER

MONTAGE 6

MONTAGE 7

MONTAGE 8

Owner's Manual



SPECIAL MESSAGE SECTION

PRODUCT SAFETY MARKINGS: Yamaha electronic products may have either labels similar to the graphics shown below or molded/stamped facsimiles of these graphics on the enclosure. The explanation of these graphics appears on this page. Please observe all cautions indicated on this page and those indicated in the safety instruction section.

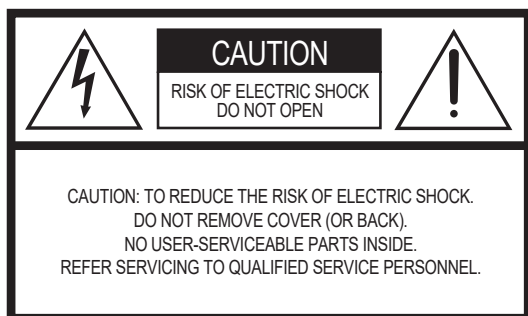

The exclamation point within the equilateral triangle is intended to alert the user to the presence of important operating and maintenance (servicing) instructions in the literature accompanying the product.

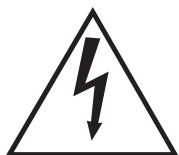

The lightning flash with arrowhead symbol, within the equilateral triangle, is intended to alert the user to the presence of uninsulated “dangerous voltage” within the product’s enclosure that may be of sufficient magnitude to constitute a risk of electrical shock.

IMPORTANT NOTICE: All Yamaha electronic products are tested and approved by an independent safety testing laboratory in order that you may be sure that when it is properly installed and used in its normal and customary manner, all foreseeable risks have been eliminated. **DO NOT** modify this unit or commission others to do so unless specifically authorized by Yamaha. Product performance and/or safety standards may be diminished. Claims filed under the expressed warranty may be denied if the unit is/has been modified. Implied warranties may also be affected.

SPECIFICATIONS SUBJECT TO CHANGE: The information contained in this manual is believed to be correct at the time of printing. However, Yamaha reserves the right to change or modify any of the specifications without notice or obligation to update existing units.

ENVIRONMENTAL ISSUES: Yamaha strives to produce products that are both user safe and environmentally friendly. We sincerely believe that our products and the production methods used to produce them, meet these goals. In keeping with both the letter and the spirit of the law, we want you to be aware of the following:

Battery Notice: This product **MAY** contain a small non-rechargeable battery which (if applicable) is soldered in place. The average life span of this type of battery is approximately five years. When replacement becomes necessary, contact a qualified service representative to perform the replacement.

Warning: Do not attempt to recharge, disassemble, or incinerate this type of battery. Keep all batteries away from children. Dispose of used batteries promptly and as regulated by applicable laws. Note: In some areas, the servicer is required by law to return the defective parts. However, you do have the option of having the servicer dispose of these parts for you.

Disposal Notice: Should this product become damaged beyond repair, or for some reason its useful life is considered to be at an end, please observe all local, state, and federal regulations that relate to the disposal of products that contain lead, batteries, plastics, etc.

NOTICE: Service charges incurred due to lack of knowledge relating to how a function or effect works (when the unit is operating as designed) are not covered by the manufacturer’s warranty, and are therefore the owners responsibility. Please study this manual carefully and consult your dealer before requesting service.

NAME PLATE LOCATION: The graphic below indicates the location of the name plate. The model number, serial number, power requirements, etc., are located on this plate. You should record the model number, serial number, and the date of purchase in the spaces provided below and retain this manual as a permanent record of your purchase.

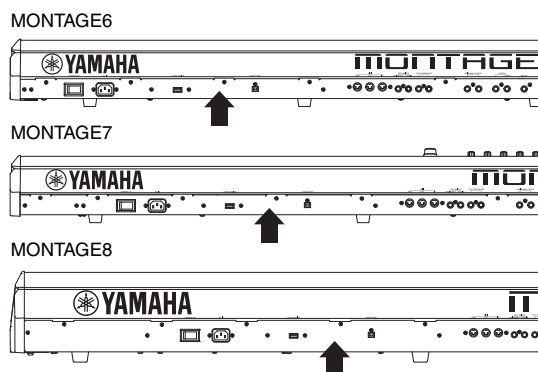

Model _____

Serial No. _____

Purchase Date _____

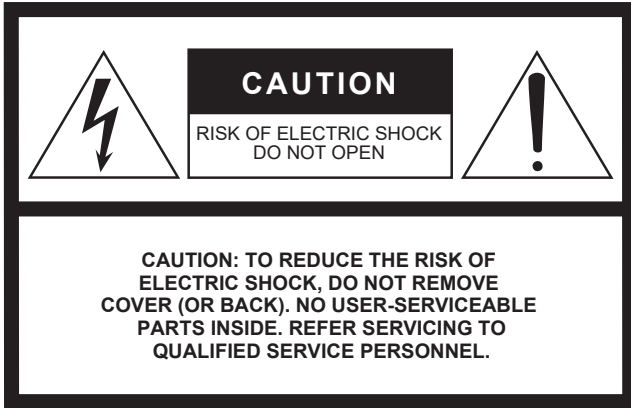

The above warning is located on the rear of the unit.

Explanation of Graphical Symbols

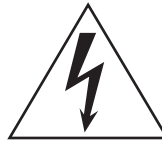

The lightning flash with arrowhead symbol within an equilateral triangle is intended to alert the user to the presence of uninsulated “dangerous voltage” within the product’s enclosure that may be of sufficient magnitude to constitute a risk of electric shock to persons.



The exclamation point within an equilateral triangle is intended to alert the user to the presence of important operating and maintenance (servicing) instructions in the literature accompanying the product.

IMPORTANT SAFETY INSTRUCTIONS

- 1 Read these instructions.
- 2 Keep these instructions.
- 3 Heed all warnings.
- 4 Follow all instructions.
- 5 Do not use this apparatus near water.
- 6 Clean only with dry cloth.
- 7 Do not block any ventilation openings. Install in accordance with the manufacturer’s instructions.
- 8 Do not install near any heat sources such as radiators, heat registers, stoves, or other apparatus (including amplifiers) that produce heat.
- 9 Do not defeat the safety purpose of the polarized or grounding-type plug. A polarized plug has two blades with one wider than the other. A grounding type plug has two blades and a third grounding prong. The wide blade or the third prong are provided for your safety. If the provided plug does not fit into your outlet, consult an electrician for replacement of the obsolete outlet.
- 10 Protect the power cord from being walked on or pinched particularly at plugs, convenience receptacles, and the point where they exit from the apparatus.
- 11 Only use attachments/accessories specified by the manufacturer.
- 12 Use only with the cart, stand, tripod, bracket, or table specified by the manufacturer, or sold with the apparatus. When a cart is used, use caution when moving the cart/apparatus combination to avoid injury from tip-over.
- 13 Unplug this apparatus during lightning storms or when unused for long periods of time.
- 14 Refer all servicing to qualified service personnel. Servicing is required when the apparatus has been damaged in any way, such as power-supply cord or plug is damaged, liquid has been spilled or objects have fallen into the apparatus, the apparatus has been exposed to rain or moisture, does not operate normally, or has been dropped.



WARNING

TO REDUCE THE RISK OF FIRE OR ELECTRIC SHOCK, DO NOT EXPOSE THIS APPARATUS TO RAIN OR MOISTURE.

(UL60065_03)

The model number, serial number, power requirements, etc., may be found on or near the name plate, which is at the rear of the unit. You should note this serial number in the space provided below and retain this manual as a permanent record of your purchase to aid identification in the event of theft.

Model No.

Serial No.

(rear_en_01)

FCC INFORMATION (U.S.A.)

1. IMPORTANT NOTICE: DO NOT MODIFY THIS UNIT!

This product, when installed as indicated in the instructions contained in this manual, meets FCC requirements. Modifications not expressly approved by Yamaha may void your authority, granted by the FCC, to use the product.

2. IMPORTANT: When connecting this product to accessories and/or another product use only high quality shielded cables. Cable/s supplied with this product **MUST** be used. Follow all installation instructions. Failure to follow instructions could void your FCC authorization to use this product in the USA.

3. NOTE: This product has been tested and found to comply with the requirements listed in FCC Regulations, Part 15 for Class "B" digital devices. Compliance with these requirements provides a reasonable level of assurance that your use of this product in a residential environment will not result in harmful interference with other electronic devices. This equipment generates/uses radio frequencies and, if not installed and used according to the instructions found in the users manual, may cause interference harmful to the operation of other electronic devices. Compliance

with FCC regulations does not guarantee that interference will not occur in all installations. If this product is found to be the source of interference, which can be determined by turning the unit "OFF" and "ON", please try to eliminate the problem by using one of the following measures:

Relocate either this product or the device that is being affected by the interference.

Utilize power outlets that are on different branch (circuit breaker or fuse) circuits or install AC line filter/s.

In the case of radio or TV interference, relocate/reorient the antenna. If the antenna lead-in is 300 ohm ribbon lead, change the lead-in to co-axial type cable.

If these corrective measures do not produce satisfactory results, please contact the local retailer authorized to distribute this type of product. If you can not locate the appropriate retailer, please contact Yamaha Corporation of America, Electronic Service Division, 6600 Orangethorpe Ave, Buena Park, CA90620

The above statements apply **ONLY** to those products distributed by Yamaha Corporation of America or its subsidiaries.

* This applies only to products distributed by YAMAHA CORPORATION OF AMERICA.

(class B)

COMPLIANCE INFORMATION STATEMENT (DECLARATION OF CONFORMITY PROCEDURE)

Responsible Party : Yamaha Corporation of America

Address : 6600 Orangethorpe Ave.,
Buena Park, Calif. 90620

Telephone : 714-522-9011

Type of Equipment : Music Synthesizer

Model Name : MONTAGE6, MONTAGE7, MONTAGE8

This device complies with Part 15 of the FCC Rules.

Operation is subject to the following two conditions:

- 1) this device may not cause harmful interference, and
- 2) this device must accept any interference received including interference that may cause undesired operation.

See user manual instructions if interference to radio reception is suspected.

* This applies only to products distributed by
YAMAHA CORPORATION OF AMERICA.

(FCC DoC)

IMPORTANT NOTICE FOR THE UNITED KINGDOM

Connecting the Plug and Cord

WARNING: THIS APPARATUS MUST BE EARTHED IMPORTANT. The wires in this mains lead are coloured in accordance with the following code:

| | |
|------------------|-----------|
| GREEN-AND-YELLOW | : EARTH |
| BLUE | : NEUTRAL |
| BROWN | : LIVE |

As the colours of the wires in the mains lead of this apparatus may not correspond with the coloured markings identifying the terminals in your plug proceed as follows:

The wire which is coloured GREEN-and-YELLOW must be connected to the terminal in the plug which is marked by the letter E or by the safety earth symbol  or colored GREEN or GREEN-and-YELLOW.

The wire which is coloured BLUE must be connected to the terminal which is marked with the letter N or coloured BLACK.

The wire which is coloured BROWN must be connected to the terminal which is marked with the letter L or coloured RED.

(3 wires)

Information for Users on Collection and Disposal of Old Equipment



This symbol on the products, packaging, and/or accompanying documents means that used electrical and electronic products should not be mixed with general household waste.

For proper treatment, recovery and recycling of old products, please take them to applicable collection points, in accordance with your national legislation and the Directives 2002/96/EC.

By disposing of these products correctly, you will help to save valuable resources and prevent any potential negative effects on human health and the environment which could otherwise arise from inappropriate waste handling.

For more information about collection and recycling of old products, please contact your local municipality, your waste disposal service or the point of sale where you purchased the items.

[For business users in the European Union]

If you wish to discard electrical and electronic equipment, please contact your dealer or supplier for further information.

[Information on Disposal in other Countries outside the European Union]

This symbol is only valid in the European Union. If you wish to discard these items, please contact your local authorities or dealer and ask for the correct method of disposal.

(weee_eu_en_01)

PRECAUTIONS

PLEASE READ CAREFULLY BEFORE PROCEEDING

Please keep this manual in a safe and handy place for future reference.



WARNING

Always follow the basic precautions listed below to avoid the possibility of serious injury or even death from electrical shock, short-circuiting, damages, fire or other hazards. These precautions include, but are not limited to, the following:

Power supply/Power cord

- Do not place the power cord near heat sources such as heaters or radiators. Also, do not excessively bend or otherwise damage the cord, or place heavy objects on it.
- Only use the voltage specified as correct for the instrument. The required voltage is printed on the name plate of the instrument.
- Use only the supplied power cord/plug.
- Check the electric plug periodically and remove any dirt or dust which may have accumulated on it.
- Be sure to connect to an appropriate outlet with a protective grounding connection. Improper grounding can result in electrical shock.

Do not open

- This instrument contains no user-serviceable parts. Do not open the instrument or attempt to disassemble or modify the internal components in any way. If it should appear to be malfunctioning, discontinue use immediately and have it inspected by qualified Yamaha service personnel.

Water warning

- Do not expose the instrument to rain, use it near water or in damp or wet conditions, or place on it any containers (such as vases, bottles or glasses) containing liquids which might spill into any openings. If any liquid such as water seeps into the instrument, turn off the power immediately and unplug the power cord from the AC outlet. Then have the instrument inspected by qualified Yamaha service personnel.
- Never insert or remove an electric plug with wet hands.

Fire warning

- Do not put burning items, such as candles, on the unit. A burning item may fall over and cause a fire.

If you notice any abnormality

- When one of the following problems occur, immediately turn off the power switch and disconnect the electric plug from the outlet. Then have the device inspected by Yamaha service personnel.
 - The power cord or plug becomes frayed or damaged.
 - It emits unusual smells or smoke.
 - Some object has been dropped into the instrument.
 - There is a sudden loss of sound during use of the instrument.

CAUTION

Always follow the basic precautions listed below to avoid the possibility of physical injury to you or others, or damage to the instrument or other property. These precautions include, but are not limited to, the following:

Power supply/Power cord

- Do not connect the instrument to an electrical outlet using a multiple-connector. Doing so can result in lower sound quality, or possibly cause overheating in the outlet.
- When removing the electric plug from the instrument or an outlet, always hold the plug itself and not the cord. Pulling by the cord can damage it.
- Remove the electric plug from the outlet when the instrument is not to be used for extended periods of time, or during electrical storms.

Location

- Do not place the instrument in an unstable position where it might accidentally fall over.
- When transporting or moving the instrument, always use two or more people. Attempting to lift the instrument by yourself may damage your back, result in other injury, or cause damage to the instrument itself.
- Before moving the instrument, remove all connected cables, to prevent damage to the cables or injury to anyone who might trip over them.
- When setting up the product, make sure that the AC outlet you are using is easily accessible. If some trouble or malfunction occurs, immediately turn off the power switch and disconnect the plug from the outlet. Even when the power switch is turned off, electricity is still flowing to the product at the minimum level. When you are not using the product for a long time, make sure to unplug the power cord from the wall AC outlet.

Connections

- Before connecting the instrument to other electronic components, turn off the power for all components. Before turning the power on or off for all components, set all volume levels to minimum.
- Be sure to set the volumes of all components at their minimum levels and gradually raise the volume controls while playing the instrument to set the desired listening level.

Handling caution

- Never insert or drop paper, metallic, or other objects into the gaps on the panel or keyboard. This could cause physical injury to you or others, damage to the instrument or other property, or operational failure.
- Do not rest your weight on, or place heavy objects on the instrument, and do not use excessive force on the buttons, switches or connectors.
- Do not use the instrument/device or headphones for a long period of time at a high or uncomfortable volume level, since this can cause permanent hearing loss. If you experience any hearing loss or ringing in the ears, consult a physician.

Yamaha cannot be held responsible for damage caused by improper use or modifications to the instrument, or data that is lost or destroyed.

Always turn the power off when the instrument is not in use.

Even when the [STANDBY/ON] switch is in standby status (display is off), electricity is still flowing to the instrument at the minimum level.

When you are not using the instrument for a long time, make sure you unplug the power cord from the wall AC outlet.

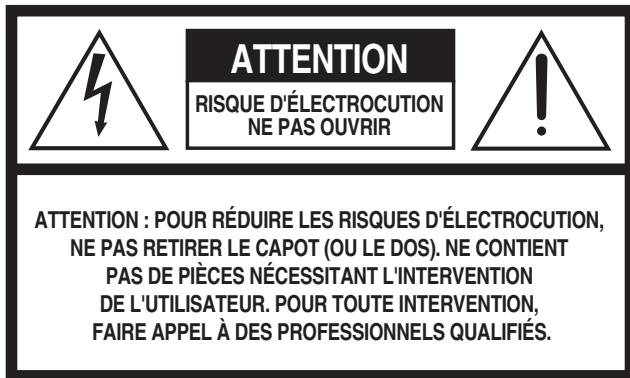

L'avertissement ci-dessus se trouve à l'arrière de l'instrument.

Explication des symboles graphiques

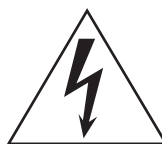

L'éclair avec une flèche à l'intérieur d'un triangle équilatéral est destiné à attirer l'attention de l'utilisateur sur la présence d'une « tension dangereuse » non isolée à l'intérieur de l'appareil, pouvant être suffisamment élevée pour constituer un risque d'électrocution.



Le point d'exclamation à l'intérieur d'un triangle équilatéral est destiné à attirer l'attention de l'utilisateur sur la présence d'instructions importantes sur l'emploi ou la maintenance (réparation) de l'appareil dans la documentation fournie.

CONSIGNES DE SÉCURITÉ À LIRE ATTENTIVEMENT

- 1 Lisez les instructions ci-après.
- 2 Conservez ces instructions.
- 3 Tenez compte des avertissements.
- 4 Suivez toutes les instructions.
- 5 N'utilisez pas cet instrument dans un milieu humide.
- 6 Employez uniquement un chiffon sec pour nettoyer l'instrument.
- 7 N'obstruez pas les ouvertures prévues pour la ventilation. Installez l'instrument conformément aux instructions du fabricant.
- 8 N'installez pas l'instrument près d'une source de chaleur, notamment un radiateur, une bouche de chaleur, un poêle ou autres (y compris les amplificateurs).
- 9 Ne modifiez pas les caractéristiques de la fiche avec mise à la terre polarisée. Une fiche polarisée est dotée de deux broches (l'une est plus large que l'autre). Une fiche avec mise à la terre comprend deux broches, ainsi qu'une troisième qui relie l'instrument à la terre. La broche la plus large (ou troisième broche) permet de sécuriser l'installation électrique. Si vous ne pouvez pas brancher le cordon d'alimentation dans la prise d'alimentation, demandez à un électricien de la remplacer.
- 10 Protégez le cordon d'alimentation. Cela permet d'éviter de marcher dessus ou de le tordre au niveau de la fiche, de la prise d'alimentation et des points de contact sur l'instrument.
- 11 N'employez que les dispositifs/accessoires indiqués par le fabricant.
- 12 Utilisez uniquement le chariot, le socle, le trépied, le support ou le plan indiqués par le fabricant ou livrés avec l'instrument. Si vous utilisez un chariot, soyez prudent si vous le déplacez avec l'instrument posé dessus pour éviter de le renverser.
- 13 Débranchez l'instrument en cas d'orage ou lorsque vous ne l'utilisez pas pendant des périodes prolongées.
- 14 Confiez toutes les réparations à des techniciens qualifiés. Des réparations sont nécessaires lorsque l'instrument est endommagé, notamment dans les cas suivants : cordon d'alimentation ou fiche défectueuse, liquides ou objets projetés sur l'appareil, exposition aux intempéries ou à l'humidité, fonctionnement anormal ou chute.



AVERTISSEMENT

N'UTILISEZ PAS L'INSTRUMENT SOUS LA PLUIE OU DANS UN ENVIRONNEMENT HUMIDE, FAUTE DE QUOI VOUS RISQUEZ DE PROVOQUER UN INCENDIE OU DE VOUS ÉLECTROCUTER.

(UL60065_03)

Le numéro de modèle, le numéro de série, l'alimentation requise, etc., se trouvent sur ou près de la plaque signalétique du produit, située à l'arrière de l'unité. Notez le numéro de série dans l'espace fourni ci-dessous et conservez ce manuel en tant que preuve permanente de votre achat afin de faciliter l'identification du produit en cas de vol.

N° de modèle

N° de série

(rear_fr_01)

PRÉCAUTIONS D'USAGE

PRIÈRE DE LIRE ATTENTIVEMENT AVANT DE PROCÉDER À TOUTE MANIPULATION

Rangez ce manuel en lieu sûr et à portée de main afin de pouvoir le consulter ultérieurement.



AVERTISSEMENT

Veillez à toujours observer les précautions élémentaires énumérées ci-après pour éviter de graves blessures, voire la mort, en raison d'une électrocution, d'un court-circuit, de dégâts, d'un incendie ou de tout autre risque. La liste de ces précautions n'est pas exhaustive :

Alimentation/cordon d'alimentation

- Ne laissez pas le cordon d'alimentation à proximité de sources de chaleur telles que les radiateurs ou les éléments chauffants. Évitez également de le plier de façon excessive ou de l'endommager de quelque manière que ce soit ou de placer dessus des objets lourds.
- Utilisez uniquement la tension requise pour l'instrument. Celle-ci est indiquée sur la plaque du fabricant de l'instrument.
- Utilisez exclusivement le cordon et la fiche d'alimentation fournis.
- Vérifiez périodiquement l'état de la fiche électrique, dépoussiérez-la et nettoyez-la.
- Veillez à brancher l'instrument sur une prise appropriée raccordée à la terre. Toute installation non correctement mise à la terre présente un risque de décharge électrique.

Ne pas ouvrir

- L'instrument ne contient aucune pièce nécessitant l'intervention de l'utilisateur. N'ouvrez pas l'instrument et ne tentez pas d'en démonter les éléments internes ou de les modifier de quelque façon que ce soit. Si l'appareil présente des signes de dysfonctionnement, mettez-le immédiatement hors tension et faites-le contrôler par un technicien Yamaha qualifié.

Prévention contre l'eau

- Ne laissez pas l'instrument sous la pluie et ne l'utilisez pas près d'une source d'eau ou dans un milieu humide. Ne déposez pas dessus des récipients (tels que des vases, des bouteilles ou des verres) contenant des liquides qui risqueraient de s'infiltrer par les ouvertures. Si un liquide, tel que de l'eau, pénètre à l'intérieur de l'instrument, mettez immédiatement ce dernier hors tension et débranchez le cordon d'alimentation de la prise secteur. Faites ensuite contrôler l'instrument par un technicien Yamaha qualifié.
- N'essayez jamais de retirer ou d'insérer une fiche électrique avec les mains mouillées.

Prévention contre les incendies

- Ne déposez pas des objets présentant une flamme, tels que des bougies, sur l'instrument. Ceux-ci pourraient se renverser et provoquer un incendie.

En cas d'anomalie

- Si l'un des problèmes suivant survient, coupez immédiatement l'alimentation et retirez la fiche électrique de la prise. Faites ensuite contrôler l'appareil par un technicien Yamaha.
 - Le cordon électrique s'effiloche ou est endommagé.
 - L'instrument dégage une odeur inhabituelle ou de la fumée.
 - Un objet est tombé à l'intérieur de l'instrument.
 - Une brusque perte de son est intervenue durant l'utilisation de l'instrument.

ATTENTION

Observez toujours les précautions élémentaires reprises ci-dessous pour éviter tout risque de blessures corporelles, pour vous-même ou votre entourage, ainsi que la détérioration de l'instrument ou de tout autre bien. La liste de ces précautions n'est pas exhaustive :

Alimentation/cordon d'alimentation

- N'utilisez pas de connecteur multiple pour brancher l'instrument sur une prise secteur. Cela risque d'affecter la qualité du son, voire de provoquer la surchauffe de la prise.
- Veillez à toujours saisir la fiche, et non le cordon, pour débrancher l'instrument de la prise d'alimentation. Si vous tirez sur le cordon, vous risquez de l'endommager.
- Débranchez la fiche électrique de la prise secteur lorsque vous n'utilisez pas l'instrument pendant un certain temps ou en cas d'orage.

Emplacement

- Ne placez pas l'instrument dans une position instable afin d'éviter qu'il ne tombe accidentellement.
- En cas de transport ou de déplacement de l'instrument, faites toujours appel à deux personnes au moins. En essayant de soulever l'instrument tout seul, vous risqueriez de vous faire mal au dos ou de vous blesser ou encore d'endommager l'instrument lui-même.
- Avant de déplacer l'instrument, débranchez-en tous les câbles afin d'éviter de les endommager ou de blesser quiconque risquerait de trébucher dessus.
- Lors de la configuration de l'instrument, assurez-vous que la prise secteur que vous utilisez est facilement accessible. En cas de problème ou de dysfonctionnement, coupez immédiatement l'alimentation et retirez la fiche de la prise. Même lorsque l'interrupteur d'alimentation est en position d'arrêt, du courant électrique de faible intensité continue de circuler dans l'instrument. Si vous n'utilisez pas l'instrument pendant une période prolongée, veillez à débrancher le cordon d'alimentation de la prise murale.

Connexions

- Avant de raccorder l'instrument à d'autres appareils électroniques, mettez ces derniers hors tension. Avant de mettre ces appareils sous ou hors tension, réglez tous les niveaux de volume sur le son minimal.
- Veillez également à régler tous les appareils sur le volume minimal et à augmenter progressivement les commandes de volume tout en jouant de l'instrument pour obtenir le niveau sonore souhaité.

Précautions de manipulation

- N'insérez pas et ne laissez pas tomber d'objets en papier, en métal ou autres dans les fentes du panneau ou du clavier. Vous pourriez vous blesser ou provoquer des blessures à votre entourage, endommager l'instrument ou un autre bien ou causer des dysfonctionnements au niveau de l'instrument.
- Ne vous appuyez pas sur l'instrument et ne déposez pas d'objets lourds dessus. Ne manipulez pas trop brutalement les touches, les sélecteurs et les connecteurs.
- N'utilisez pas l'instrument ou le casque de manière prolongée à des niveaux sonores trop élevés ou inconfortables qui risqueraient d'entraîner des troubles définitifs de l'audition. Si vous constatez une baisse d'acuité auditive ou que vous entendez des sifflements, consultez un médecin.

Yamaha ne peut être tenu responsable des détériorations causées par une mauvaise manipulation de l'instrument ou par des modifications apportées par l'utilisateur, ni des données perdues ou détruites.

Mettez toujours l'instrument hors tension lorsque vous ne l'utilisez pas.

Même lorsque l'interrupteur [STANDBY/ON] (Veille/Marche) est en position de veille et que le rétroéclairage de l'écran est éteint, une faible quantité d'électricité circule toujours dans l'instrument.

Lorsque vous n'utilisez pas l'instrument pendant une période prolongée, veillez à débrancher le cordon d'alimentation de la prise murale.

NOTICE

To avoid the possibility of malfunction/damage to the product, damage to data, or damage to other property, carefully observe the notices below.

■ Handling

- Do not use the instrument in the vicinity of a TV, radio, stereo equipment, mobile phone, or other electric devices. Otherwise, the instrument itself, and/or the nearby device may generate noise. When you use the instrument along with an application on your iPad, iPhone or iPod touch, we recommend that you set "Airplane Mode" to "ON" on that device in order to avoid noise caused by communication.
- Do not expose the instrument to excessive dust or vibrations, or extreme cold or heat (such as in direct sunlight, near a heater, or in a car during the day) to prevent the possibility of panel disfiguration, damage to the internal components or unstable operation.
- Do not place vinyl, plastic or rubber objects on the instrument, since this might discolor the panel or keyboard.
- When cleaning the instrument, use a soft and dry/slightly damp cloth. Do not use paint thinners, solvents, alcohol, cleaning fluids, or chemical-impregnated wiping cloths.

■ Saving data

• Edited Performance Data

Edited Performance data is lost when you turn off the power to the instrument without storing. This also occurs when the power is turned off by the Auto Power Off function (page 15).

• MIDI and System Settings

MIDI setting data and System setting data are automatically stored when those corresponding setting displays are switched to another display. Data is lost when you turn off the power to the instrument without switching displays. This also occurs when the power is turned off by the Auto Power Off function.

- Always save important data to the instrument, or to USB flash memory device (page 53). Keep in mind, however, that data saved to the instrument may occasionally be lost due to some failure, an operation mistake, etc. For this reason, you should save your important data onto USB flash memory device (page 53). Before using a USB flash memory device, make sure to refer to page 54.

Information

■ About copyrights

- Copying of commercially available musical data including but not limited to MIDI data and/or audio data is strictly prohibited except for your personal use.
- This product incorporates and bundles contents in which Yamaha owns copyrights or with respect to which Yamaha has license to use others' copyrights. Due to copyright laws and other relevant laws, you are NOT allowed to distribute media in which these contents are saved or recorded and remain virtually the same or very similar to those in the product.
 - * The contents described above include a computer program, Accompaniment Style data, MIDI data, WAVE data, voice recording data, a score, score data, etc.
 - * You are allowed to distribute medium in which your performance or music production using these contents is recorded, and the permission of Yamaha Corporation is not required in such cases.

■ About functions/data bundled with the instrument

- This device is capable of using various types/formats of music data, and automatically optimizes that data to the proper format before use. As a result, this device may not play back the data exactly as the producers or composers of the data originally intended.

■ About this manual

- The illustrations and LCD screens as shown in this manual are for instructional purposes only, and may appear somewhat different from those on your instrument.
- Square brackets indicate on-screen buttons, connectors, and buttons from the control panel.
- Windows is a registered trademark of Microsoft® Corporation in the United States and other countries.
- Apple, iTunes, Mac, Macintosh, iPhone, iPad and iPod touch are trademarks of Apple Inc., registered in the U.S. and other countries.
- IOS is a trademark or registered trademark of Cisco in the U.S. and other countries and is used under license.
- The company names and product names in this manual are the trademarks or registered trademarks of their respective companies.

Yamaha may from time to time update firmware of the product without notice for improvement in functions and usability. To take full advantage of this instrument, we recommend that you upgrade your instrument to the latest version. The latest firmware can be downloaded from the website below:
<http://download.yamaha.com/>

MEMO



A message from the MONTAGE Development Team

Thank you for purchasing the Yamaha MONTAGE6/7/8 Music Synthesizer. Since the first MOTIF was launched in 2001, the MOTIF series has reached fourth-generation status and has finally been remodeled—for the first time in 15 years—as the new MONTAGE.

The MONTAGE has an immense set of impressively high-quality sounds, exceptional playability, and a sophisticated, stylish design—making this long-awaited instrument destined to be long-loved as well.

1 High-quality sounds that take you to new creative and expressive heights

We took the bread-and-butter sounds of the MOTIF series used extensively by artists worldwide, and significantly enhanced them.

In answer to many and repeated requests from power users, we have created this new model with FM (frequency modulation) oscillators and many new effects. Moreover, the MONTAGE has a powerfully dynamic Motion Control System that lets you variably control sounds in real time, giving you the best of both worlds—tradition and innovation—in sonic expressiveness.

We improved the analog circuitry in the audio output, ensuring superior quality sound reproduction over a wide frequency range, and especially accurate reproduction over the mid and high frequency ranges with exceptional clarity.

The MONTAGE is equipped with a wide range of dynamic sounds for use in virtually any music application.

2 Controllers and user interface designed for high playability

The MONTAGE has new controllers which are useful not only as a live-performance keyboard, but also as a high-performance synthesizer. The MONTAGE's playability is maximized in live performance situations through the Live Set function, Scene function, and SSS (Seamless Sound Switching.)

Moreover, the MONTAGE has a completely new performance controller—the Super Knob—which lets you easily and expressively create multi-textured, multi-dimensional sound and music. The sound changes are synchronized with lighting changes on the Super Knob itself as well as eight other small knobs. It's almost like having a conversation with the MONTAGE, and spurring each other on to new creative heights!

The MONTAGE is comprehensively designed for intuitive, simple operation, yet with meticulous detail, and is ideal for professional musicians.

Here finally, is a musical instrument with stunning sounds, broad capabilities and deep expressiveness that is truly addictive, and will be your new go-to instrument!

We really hope that the MONTAGE6/7/8 will help your creativity and musical work grow by leaps and bounds.

Enjoy!

Sincerely,
The Yamaha MONTAGE Development Team

About This Manual

Owner's Manual (this book)

Provides overall explanations of the basic functions of the instrument. Please use this Owner's Manual for an overview of the fundamental operations of the MONTAGE. If you need more detailed information or instructions on specific functions, use the Reference Manual described below.

PDF documentation

■ Reference Manual

Explains in detail about the internal structure and connection examples. Use this manual if you need more detailed information which is not covered in the Owner's Manual.

If you need more information on the current status or display of the MONTAGE, use the Function Tree provided in this manual. This convenient Function Tree helps you quickly find the page covering the relevant function or operation.

■ Synthesizer Parameter Manual

This general, cross-product document explains parameters, effect types, effect parameters, and MIDI messages that are used for all synthesizers. Read the Owner's Manual and Reference Manual first and then use this parameter manual if necessary to learn more about parameters and terms that relate to Yamaha synthesizers in general.

■ Data List

This contains various important lists such as the Performance List, Waveform List, Effect Type List, Arpeggio Type List, and MIDI Implementation Chart.

How to use the PDF manuals

The Reference Manual, the Synthesizer Parameter Manual, and the Data List are provided as data documents in PDF format. The PDF manuals listed above can be obtained from the Yamaha Downloads web page. To do so, go to the web page using the following URL, enter "MONTAGE" into the "Model Name" field, and then click "Search."

Yamaha Downloads:

<http://download.yamaha.com/>

These PDF files can be viewed and read on a computer. When using Adobe® Reader® to view a PDF file, you can search for specific words, print a specific page or link to open a desired section in the manual. The term search and link functions are especially convenient methods of navigating through a PDF file, and we recommend that you use them. The latest version of Adobe Reader can be downloaded from the following URL.

<http://www.adobe.com/products/reader/>

Accessories

- AC power cord
- Owner's Manual (this book)
- Cubase AI Download Information

Main Features

■ High-quality, enhanced sounds covering a wide range of music styles

The MONTAGE is loaded with 5 GB (in 16-bit linear format) of preset Advanced Wave memory (AWM2) — more than seven times the size of the previous MOTIF XF6/7/8. The MONTAGE has a huge variety of sounds, including highly realistic Piano sounds, with large-volume waveform data. Unlike its predecessors, the MONTAGE features 1.7 GB of User flash memory built in, for storing various Performance libraries. The Performance data is maintained in the same way as preset Performances even if the power is turned off. The MONTAGE also now features an FM-X tone generator, providing powerfully complex FM synthesis. This puts both standard FM and new-generation FM sounds in your sonic palette, giving you a wide range of expressive, richly textured sounds to work with, and lets you combine both the FM-X and AWM2 tone generators.

■ Extensive effect processing

The MONTAGE has a huge variety of professional and modern-music effects, including Beat Repeat, Vinyl Break, Bit Crusher, and Analog Delay. The instrument also gives you a wide array of signal processing options, including separate Variation and Reverb, an overall Master Effect including multi-band compression, five-band master EQ, independent Insertion Effects, plus three-band EQ before the Insertion Effects and two-band EQ after them. These Insertion Effects contain wide variety of sound processing options, including a special Vocoder effect.

■ Motion Control System for new musical possibilities

The Motion Control System is a completely new feature for variably controlling Motions (rhythmical, multi-dimensional sound changes) in real time. This amazingly powerful feature dramatically and dynamically alters the sounds of the instrument in new, never-heard-before ways—changing texturally, rhythmically with the beats, providing cool, colorful lighting effects, and responding expressively to your creative passion.

The Motion Control System has three main functions:

1) Super Knob:

For creating multi-dimensional sonic changes, and enhancing those changes with colorful, continually shifting lighting changes.

2) Motion Sequencer:

For continually variable sound changes.

3) Envelope Follower:

Synchronizes the Motions with tempo and volume of audio input and other Parts.

■ Expanded, enhanced Arpeggio function and Motion Sequence

The MONTAGE has more than 10,000 Arpeggio types that cover the latest music styles. Further enhancing the musical expressiveness of the instrument, you can combine the Motion Sequence function for creating dynamic sound variability over time with various Arpeggio types. You can store all contents—Arpeggio Type, Motion Sequence, and other parameters such as Part volume—together as Scenes, and assign them to eight buttons, letting you conveniently and powerfully call up those Scenes as desired while you perform.

■ Exceptionally convenient live performance functions

The MONTAGE has a Live Set function for easily calling up Performances as you play onstage. Once you've stored Performances in the desired order, you can concentrate fully on your playing and never be at a loss on which to choose. The MONTAGE also has SSS (Seamless Sound Switching) function for switching between Performances smoothly without any notes being cut off.

■ Enhanced user interface

Unlike its predecessors, the MONTAGE has been designed without any "Modes." As a result, it is extremely easy to understand the structure and flow of the instrument, and the convenient touch panel is a total joy to use. You can creatively and effectively use the touch panel for intuitive operations and the switches for more secure control, if desired. These switches light in three different ways, letting you instantly understand the current status of the switches.

■ Responsive, expressive keyboard

The MONTAGE6 features a 61-key keyboard, while the MONTAGE7 has 76 keys with a high-quality FSX keyboard and the MONTAGE8 has 88 keys with a high-quality BH (Balanced Hammer) keyboard. All are equipped with a touch response feature (both initial touch and aftertouch). These allow you to expressively change the sound in various ways—initial touch by the strength with which you play the keys, and aftertouch by how strongly you press the keys when holding them down.

■ Comprehensive system connectivity

The MONTAGE features a built-in 6-channel in/32-channel out USB audio interface for recording the high-quality sound of the MONTAGE on a Mac or Windows PC—without the need for a separate device! The MONTAGE also supports high-resolution 192 kHz audio, making the ideal keyboard to take into professional-level recording situations as well. The connections are also compatible with iOS devices.

Contents

| | | | |
|---|-----------|---|-----------|
| A message from the MONTAGE Development Team | 2 | Making Global System Settings | 45 |
| About This Manual | 3 | Setting automatic power-on tasks | 45 |
| Accessories | 3 | Setting button lamp behavior | 45 |
| Main Features | 4 | Turning various functions on/off | 45 |
| Controls and Functions | 6 | Changing the Master Tuning | 46 |
| Top Panel | 6 | Changing the Velocity Curve | 47 |
| Rear Panel | 11 | Connecting External MIDI Instruments | 48 |
| Setting Up | 14 | Controlling the MONTAGE from an external MIDI keyboard or synthesizer | 48 |
| Power Supply | 14 | Controlling an external MIDI keyboard or synthesizer from the MONTAGE | 48 |
| Connecting Speakers or Headphones | 14 | Using a Connected Computer | 49 |
| Powering Up the System | 14 | Connecting to a computer | 49 |
| Auto Power Off function | 15 | Creating a Song with a computer | 51 |
| Adjusting the Master Volume output | 15 | Saving/Loading Data | 53 |
| Restoring the initial factory settings (Initialize All Data) | 15 | Saving the settings to a USB flash memory device | 53 |
| Basic Operation and Displays | 16 | Loading the settings from a USB flash memory device | 53 |
| Quick Guide — Selecting Performances | 18 | Precautions when using the [USB TO DEVICE] terminal | 54 |
| Selecting a Performance from the Live Set | 19 | Using USB flash drives | 54 |
| Switching Performances | 19 | Shift Function List | 55 |
| Using the Category Search function | 20 | Display Messages | 56 |
| Playback Audition phrase | 21 | Troubleshooting | 58 |
| Quick Guide — Playing the Keyboard | 22 | Specifications | 63 |
| Performance Play display | 22 | Index | 64 |
| Switching a Part on/off | 23 | | |
| Using the Arpeggio function | 24 | | |
| Using the Motion Sequencer function | 25 | | |
| Using controllers to change the sound | 26 | | |
| Using the Knobs to change the sound | 27 | | |
| Using the Super Knob to change the sound | 28 | | |
| Mixing | 28 | | |
| Using the Scene function | 29 | | |
| Quick Guide — Creating Your Own Live Sets | 30 | | |
| Registering a Performance to a Live Set | 30 | | |
| Sorting registered Performances in a Live Set | 30 | | |
| Quick Guide — Editing the Settings | 32 | | |
| Performance Editing | 32 | | |
| Part Editing | 33 | | |
| Part Effect Editing | 34 | | |
| How Parts are assigned to a Performance | 35 | | |
| Creating a Performance by combining Parts | 36 | | |
| Recording and Playback | 39 | | |
| Terminology | 39 | | |
| MIDI Recording | 39 | | |
| Playing a Song | 41 | | |
| Recording your performance as audio | 41 | | |
| Playing an audio file | 42 | | |
| Using as a Master Keyboard | 43 | | |
| Making settings for use as a master keyboard—Zone | 43 | | |
| Connecting a Microphone or Audio Equipment | 44 | | |
| Playing the keyboard along with the sound input from the A/D INPUT [L/MONO]/[R] jacks | 44 | | |

Controls and Functions

Top Panel

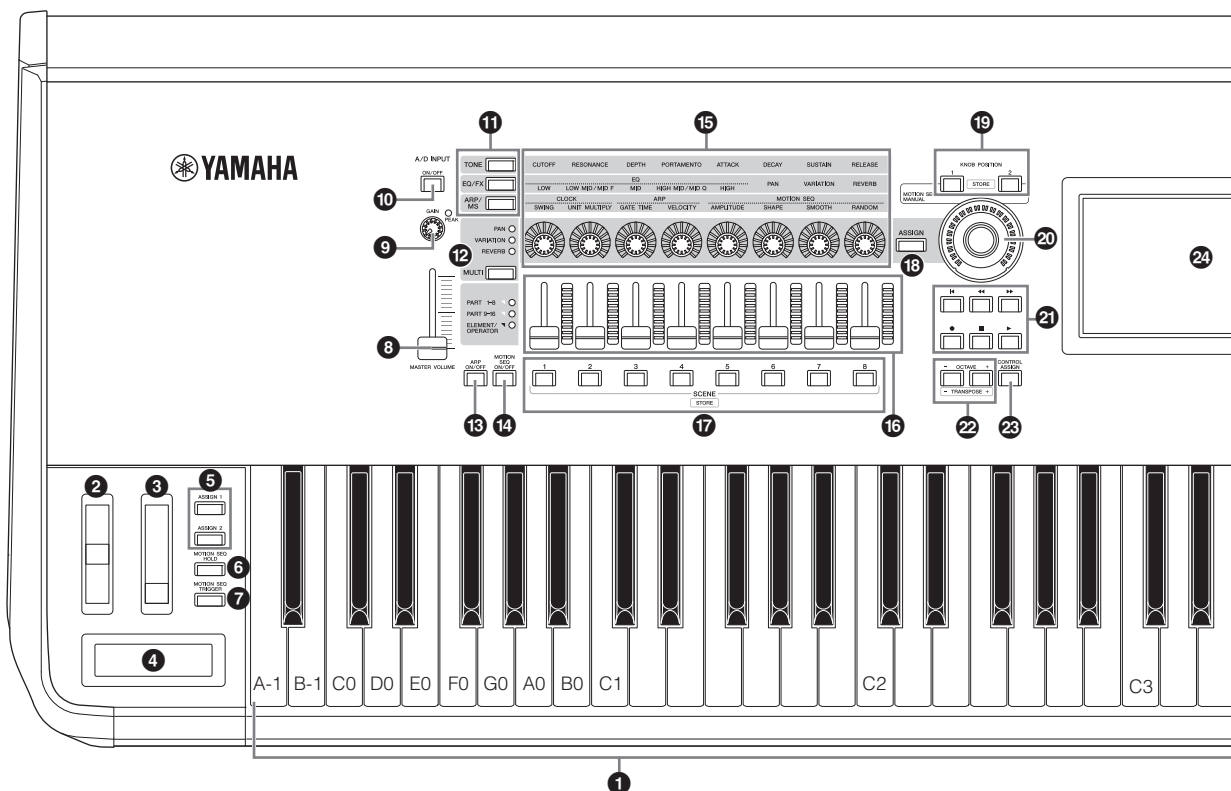

1 Keyboard

The MONTAGE6 features a 61-key keyboard, while the MONTAGE7 has 76 keys and the MONTAGE8 has 88 keys. All are equipped with a touch response feature (both initial touch and aftertouch). With initial touch, the instrument senses how strongly or softly you play the keys, and uses that playing strength to alter the sound in various ways, depending on the selected Performance. Aftertouch, on the other hand, lets you alter the sound by the amount of pressure you apply to a note after playing it. In addition, any of a variety of functions can be assigned to aftertouch for each part.

2 Pitch Bend wheel

Controls the pitch bend effect. You can also assign other functions to this controller.

3 Modulation wheel

Controls the modulation effect. You can also assign other functions to this controller.

4 Ribbon Controller

This controller is touch sensitive, and is controlled by running your finger lightly across its surface laterally. You can assign various functions to this controller as desired.

5 [ASSIGN 1] and [ASSIGN 2] buttons (Assignable switches 1 and 2)

You can call up the specific Element/Operator of the selected Performance by pressing each of these buttons during your keyboard performance. In addition, you can assign other functions to these switches. When one of these effects is turned on, the corresponding button will light up and vice-versa.

6 [MOTION SEQ HOLD] (Motion Sequencer hold) button

Pressing this button while the Motion Sequencer is playing, results in the sound being held or frozen at the exact point in the sequence when the button was pressed. When the hold effect is turned on, the button lights.

7 [MOTION SEQ TRIGGER] (Motion Sequencer trigger) button

When you press this button, the Motion Sequence starts again from the beginning. The button lights fully when pressed.

8 [MASTER VOLUME] slider (page 15)

Move the slider up or down to control the output level from the OUTPUT (BALANCED) [L/MONO]/[R] jacks and the [PHONES] jack.

The illustration shows the MONTAGE8, but the information applies to all models.

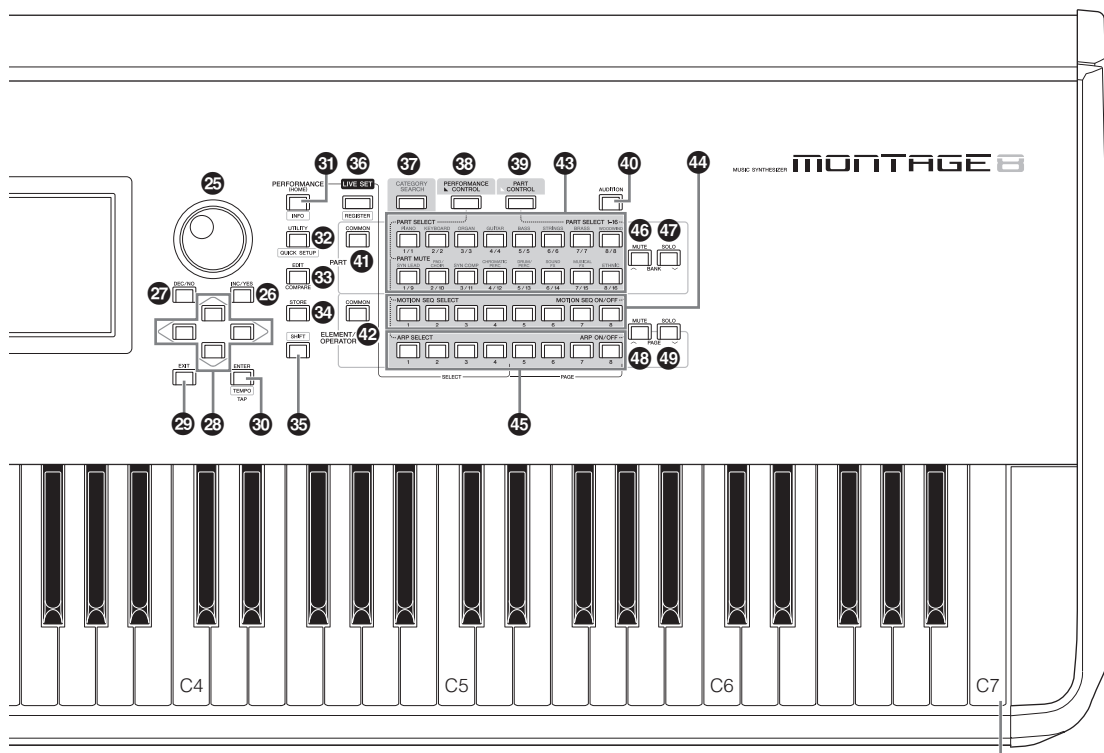

9 A/D INPUT [GAIN] knob (page 44)

Use this to adjust the input gain of the audio signals at the A/D INPUT [L/MONO]/[R] jacks. Turning the knob clockwise increases the gain level.

Detects the peak level and lights up the PEAK LED in red when the level is just short of clipping. Adjust the knob so that the corresponding PEAK LED only occasionally flashes whenever the input signal reaches the maximum level.

NOTE

You may need to change the setting depending on the input level of the external equipment connected to the A/D INPUT [L/MONO]/[R] jacks, in the following order: [UTILITY] → [Settings] → [Audio I/O] → [A/D Input]. When the output level of the connected equipment (such as a microphone, guitar or bass) is low, set this parameter to “Mic.” When the output level of the connected equipment (such as a synthesizer keyboard or CD player) is high, set this parameter to “Line.”

10 A/D INPUT [ON/OFF] button (page 44)

Switches whether or not this instrument accepts the audio signal input via the A/D INPUT [L/MONO]/[R] jack. When A/D Input is enabled, the button lights; when disabled, it turns off.

11 Knob Function [TONE]/[EQ/FX]/[ARP/MS] button

Use this button to select functions to be assigned to Knobs 1 – 8. The button next to the currently active parameters will light.

You can apply functions to be controlled commonly for all Parts by using the PART [COMMON] button, or to be

controlled for only the selected Part by using the Number A [1] – [16] buttons. The selected button will light.

12 [MULTI] (Multi Part control) button

Use this button to select functions assigned to Knobs 1 – 8. Pressing the button repeatedly switches in the following order: PAN → VARIATION → REVERB. The lamp next to the currently active parameters will light. All knobs correspond to Parts 1 – 8 or 9 – 16 (depending on the currently selected Part).

13 [ARP ON/OFF] (Arpeggio on/off) button

Press this button to enable or disable playback of the Arpeggio. If the Arpeggio Switch of the selected Part is set to off, however, pressing this button has no effect. When Arpeggio is enabled, the button lights; when disabled, it turns off.

14 [MOTION SEQ ON/OFF] (Motion Sequencer on/off) button

Determines whether the Motion Sequencer is active or not. If the Motion Sequencer switch of the selected Part or Lane is set to off, however, pressing this button has no effect. When the Motion Sequencer is active, the button lights.

15 Knobs 1 – 8

These eight highly versatile knobs let you adjust various important parameters, such as the current Part, Arpeggio tempo, and the Motion Sequencer. Pressing the knob function [TONE]/[EQ/FX]/[ARP/MS] button, the Multi part control [MULTI] button, or the Assign [ASSIGN] button in the upper left corner changes the functions assigned to the knobs.

16 Control Sliders 1 – 8

These sliders control the volume balance of the sound, by letting you adjust the individual levels of the 16 Parts (1 – 8 / 9 – 16), the eight Elements for Normal Parts (AWM2), the eight FM Operators for a Normal Part (FM-X), and eight Keys of the Drum Part, in different ways depending on the conditions of the various buttons.

| | When PART [COMMON] button is on: | When Number A [1] – [8] buttons are on: | When Number A [9] – [16] buttons are on: |
|-----------------------|----------------------------------|--|--|
| [PERFORMANCE CONTROL] | Levels of Parts 1 – 8 | Levels of Elements/Keys/Operators 1 – 8 of a selected Part | |
| [PART CONTROL] | Levels of Parts 1 – 8 | | Levels of Parts 9 – 16 |

NOTE

- If all of the Control Sliders are set to the minimum, you may not hear any sound from the instrument, even when playing the keyboard or a Song. If this is the case, raise all the sliders to a suitable level.
- The [MASTER VOLUME] slider controls the overall audio output level of this instrument. On the other hand, the Control Sliders control the level of each Element/Key/Operator of the Parts and the volume for each Part of the Performance as a parameter. Accordingly, the values set via the Control Sliders can be stored as Performance data.

17 SCENE [1] – [8] buttons

You can assign different “snapshots” of important Part-related parameters such as track mute status and the basic Mixing setup to the SCENE [1] – [8] buttons as Part Scenes. When Scene-related parameters are edited and press any of the SCENE [1] – [8] buttons while holding down the [SHIFT] button, the edit is stored for the currently selected [SCENE] button. The stored information is restored by pressing the selected button. The currently selected button fully lights, the button stored information lights dimly, and the button without stored information is turned off.

18 [ASSIGN] button

Switches the functions assigned to knobs as Assign 1 – 8. By using the PART [COMMON] button and the Number A [1] – [16] buttons, you can set whether the functions are commonly effective for all Parts or only for one selected Part. When the effect is turned on, the corresponding button lights.

19 KNOB POSITION [1] and [2] buttons

Stores the parameter values of Assign 1 – 8. You can instantly switch between the two buttons.

20 Super Knob

Simultaneously controls the parameters (Assign 1 – 8) assigned to the eight knobs.

NOTE

You can also control the Super Knob by using the foot controller (FC7). For details, refer to page 28.

21 SEQ TRANSPORT button

These buttons control recording and playback of the Song sequence data.

[◀] (Top) button

Instantly returns to the beginning of the current Song (i.e., the first beat of the first measure).

[◀◀] (Reverse) button

Press briefly to move back one measure at a time.

[▶▶] (Forward) button

Press briefly to move forward one measure at a time.

[●] (Record) button

Press this to call up the Record setup display. (The button flashes.) Press the [▶] (Play) button to start recording. (The [●] (Record) button lights.)

[■] (Stop) button

Press to stop recording or playback. This button can also be used when you want to stop Arpeggio playback, even when Arpeggio is set to continue playback even after the note is released (Arpeggio hold switch is ON).

[▶] (Play) button

Press to start playback or recording of a Song. During recording and playback, the button flashes at the current tempo.

22 OCTAVE [-] and [+] buttons

Use these buttons to change the octave range of the keyboard. These buttons also function as Transpose [-] and [+] buttons. To lower or raise the pitch of the note in semitone steps, hold down the [SHIFT] button and press the corresponding [-]/[+] button. To restore the normal octave setting, press both buttons simultaneously. The buttons light or flash in different ways depending on the octave setting. For details, see the Reference Manual PDF document.

23 [CONTROL ASSIGN] button

While the parameter assignable to controllers is selected on the display, press this button and operate the desired controller for assignment. The controller setting display appears.

24 Touch panel LCD

The LCD indicates the parameters and values related to the currently selected operation. You can operate by touching the display.

25 Data dial

For editing the currently selected parameter. To increase the value, turn the dial right (clockwise); to decrease the value, turn the dial left (counter-clockwise). If a parameter with a wide value range is selected, you can change the value in broader strokes by quickly turning the dial.

26 [INC/YES] button

For increasing the value of the currently selected parameter (INC: increment). This button can also be used to execute a Job or Store operation.

Simultaneously hold down the [SHIFT] button and press the [INC/YES] button to quickly increase the parameter value in 10-step jumps.

27 [DEC/NO] button

For decreasing the value of the currently selected parameter (DEC: decrement). This button can also be used to cancel a Job or Store operation.

Simultaneously hold down the [SHIFT] button and press the [DEC/NO] button to quickly decrease the parameter value in 10-step jumps.

28 Cursor buttons

The cursor buttons move the “cursor” around the display, highlighting and selecting the various parameters.

29 [EXIT] button

The menus and displays of the MONTAGE are organized according to a hierarchical structure. Press this button to exit from the current display and return to the previous level in the hierarchy.

30 [ENTER] button

Use this button to call up the display of the selected menu, or to execute a Job or Store operation.

Simultaneously hold down the [SHIFT] button and press the [ENTER] button to call up the Tempo setting display.

31 [PERFORMANCE] button

Use this button to return to the Performance Play display. The button fully lights when the Performance Play display is shown. This button lights dimly when the Utility display is shown.

Simultaneously hold down the [SHIFT] button and press the [PERFORMANCE] button to call up the Overview display.

32 [UTILITY] button

Use this button to call up the Utility display for making overall system settings. The button fully lights when the Utility display is shown and the button lights dimly when other displays are shown.

Simultaneously hold down the [SHIFT] button and press the [UTILITY] button to call up the Quick setup display.

33 [EDIT] button

Use this button to call up the display for editing Performances (page 18) and Live Sets (page 30). Also, pressing this button while editing Performance parameters lets you switch between the just-edited sound and its original, unedited condition, allowing you to hear how your edits affect the sound (Compare function). The button lights when the edit display is shown and the button flashes while Compare is active.

34 [STORE] button

Use this button to call up the Store display. The button fully lights when the Store display is shown and the button lights dimly when other displays are shown.

35 [SHIFT] button

Pressing this button along with another button enables you to execute various commands. For details, refer to the “Shift Function List” (page 55).

36 [LIVE SET] button

Use this button to store all your favorite, often-used Performances in a single, easy-to-access location and call them up.

Simultaneously hold down the [SHIFT] button and press the [LIVE SET] button to call up the Live Set display for storing the currently selected Performance to the Live Set. This is one more useful way you can quickly switch among Performances you need in live performance situations.

The button fully lights when the Live Set display is shown. If the Live Set display is not shown, the button lights dimly when the Live Set function is active and the button’s lamp is off when the function is NOT active.

37 [CATEGORY SEARCH] button

The Category Search function (page 20) can be accessed by using this button.

Use this button while the Performance Play display is shown to call up the Performance Category Search display for selecting the entire Performance. When the cursor is on the Part name in the Performance Play display, simultaneously hold down the [SHIFT] button and press the [CATEGORY SEARCH] button to call up the Part Category Search display, allowing you to select a sound type for the currently selected Part. The button fully lights when the Category Search display is shown. If the Category Search display is not shown, the button lights dimly when the Category Search function is active and the button’s lamp is off when the function is NOT active.

38 [PERFORMANCE CONTROL] button

Use this button with the Number A [1] – [16] buttons, the Number B [1] – [8] buttons, and the Number C [1] – [8] buttons, the PART [MUTE] button, and the PART [SOLO] button to control Performances. When this button is turned on, the following functions can be operated. The button fully lights when it is turned on and the button lights dimly when it is turned off.

| Number buttons | PART [MUTE] button ON | PART [SOLO] button ON |
|--|---|-----------------------|
| Number A [1] – [8] buttons (upper line) | Part select (1 – 8) | Part solo (1 – 8) |
| Number A [9] – [16] buttons (lower line) | Part mute (1 – 8) | Part solo (1 – 8) |
| Number B [1] – [8] buttons | Switch of Motion Sequence types (1 – 8) | |
| Number C [1] – [8] buttons | Switch of Arpeggio types (1 – 8) | |

39 [PART CONTROL] button

Use this button with the Number A [1] – [16] buttons, the Number B [1] – [8] buttons, and the Number C [1] – [8] buttons, the PART [MUTE] button, and the PART [SOLO] button to control Parts. When this button is turned on, the following functions can be operated. The button fully lights when it is turned on and the button lights dimly when it is turned off.

| Number buttons | PART [MUTE] button and PART [SOLO] are OFF | PART [MUTE] button ON | PART [SOLO] button ON |
|--|--|-----------------------|-----------------------|
| Number A [1] – [8] buttons (upper line) | Part select (1 – 8) | Part mute (1 – 8) | Part select (1 – 8) |
| Number A [9] – [16] buttons (lower line) | Part select (9 – 16) | Part mute (9 – 16) | Part solo (9 – 16) |
| Number B [1] – [8] buttons | Motion Sequencer for each Part ON/OFF (1 – 8 / 9 – 16) | | |
| Number C [1] – [8] buttons | Arpeggio for each Part ON/OFF (1 – 8 / 9 – 16) | | |

40 [AUDITION] button

Use this button (in the Performance Play, Live Set, or Category Search displays) to play back or stop a sample phrase showcasing the selected Performance sound. This sample phrase of the Performance is called the “Audition phrase.” The button fully lights when it is ON and the button lights dimly when the Audition function is active such as in the Category Search display.

41 PART [COMMON] button

Turning on this button lets you edit the parameters commonly applied to all Parts. The button fully lights when it is turned on and the button lights dimly when it is turned off.

42 ELEMENT/OPERATOR [COMMON] button

Turning this button on lets you edit the parameters commonly applied to all Elements/Keys/Operators. The button fully lights when it is turned on and the button lights dimly when it is turned off.

43 Number A [1] – [16] buttons

Use these buttons to select Parts on the Performance Play display and the Edit display. The buttons can also be used to select a main category from the Category Search display. In the Live Set display, the Number A [1] – [4] buttons can be used to select Performances in the first line, and the Number A [9] – [12] buttons can be used to select Performances in the second line. The Number A [5] – [8] buttons can be used to select Live Set pages 1 – 4, and the Number A [13] – [16] buttons can be used to select Live Set pages 5 – 8. According to each of the displays, the button fully lights when it is selected, the button lights dimly when it is selectable, and the button lamp is off when not selectable. (Only in the case of selecting pages in the Live Set display, this button can be used even if the lamp is off.)

44 Number B [1] – [8] buttons

Use these buttons to select Motion Sequencer types on the Performance Play display and to turn the Motion Sequencer for each Part ON/OFF. The buttons can be used to select Elements/Keys/Operators from the Edit display. The buttons can also be used to select sub categories from the Category Search display. In the Live Set display, the Number B [1] – [4] buttons can be used to select Performances in the third line, and the Number B [5] – [8] buttons can be used to select Live Set pages 9 – 12. According to each of the displays, the button fully lights when it is selected, the button lights dimly when it is selectable, and the button lamp is off when not selectable.

(Only in the case of selecting pages in the Live Set display, this button can be used even if the lamp is off.)

45 Number C [1] – [8] buttons

Use these buttons to select Arpeggio types on the Performance Play display and to turn the Arpeggio for each Part ON/OFF. The buttons can be used to mute Elements/Keys/Operators from the Edit display. The buttons can also be used to select Performances from the Category Search display. In the Live Set display, the Number C [1] – [4] buttons can be used to select Performances in the fourth line, and the Number C [5] – [8] buttons can be used to select Live Set pages 13 – 16. According to each of the displays, the button fully lights when it is selected, the button lights dimly when it is selectable, and the button lamp is off when not selectable. (Only in the case of selecting pages in the Live Set display, this button can be used even if the lamp is off.)

46 PART [MUTE] button

By turning this button on, the Number A [1] – [16] buttons can be used as mute on/off controls. The button fully lights when it is turned on and the button lights dimly when it is turned off. The button can also be used to switch Live Set banks from the Live Set display.

47 PART [SOLO] button

By turning this button on, the Number A [1] – [16] buttons can be used as solo on/off controls for Parts. The button fully lights when it is turned on and the button lights dimly when it is turned off. The button can also be used to switch Live Set banks from the Live Set display.

48 ELEMENT/OPERATOR [MUTE] button

By turning this button on, the Number B [1] – [8] buttons can be used to select Elements/Keys/Operators 1 – 8, and the Number C [1] – [8] buttons can be used as mute on/off controls for Elements/Keys/Operators 1 – 8. The button lights dimly when it works as mute on, and fully lights when it works as mute off. For operations other than Part editing, the button is off. The button can also be used to switch Live Set banks from the Live Set display.

49 ELEMENT/OPERATOR [SOLO] button

By turning this button on, the Number B [1] – [8] buttons (or the Number C [1] – [8] buttons) can be used to as solo on/off controls for Elements 1 – 8. The button fully lights when solo is on, and lights dimly when solo is off. In other situations, except for Part editing operations, the button is off. The button can also be used to switch Live Set banks from the Live Set display.

| Number buttons | ELEMENT/OPERATOR [MUTE] button ON | ELEMENT/OPERATOR [SOLO] button ON |
|----------------------------|-----------------------------------|-----------------------------------|
| Number B [1] – [8] buttons | Element select (1 – 8) | Element solo (1 – 8) |
| Number C [1] – [8] buttons | Element mute (1 – 8) | Element solo (1 – 8) |

Rear Panel

Left side of Rear Panel

The illustration shows the MONTAGE8, but the information applies to all models.

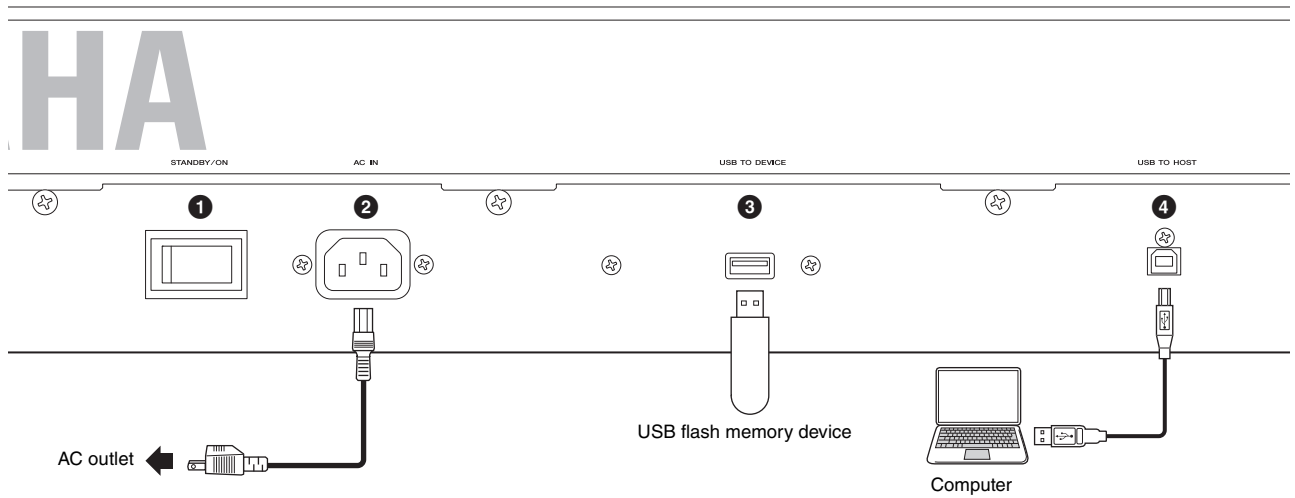

Right side of Rear Panel

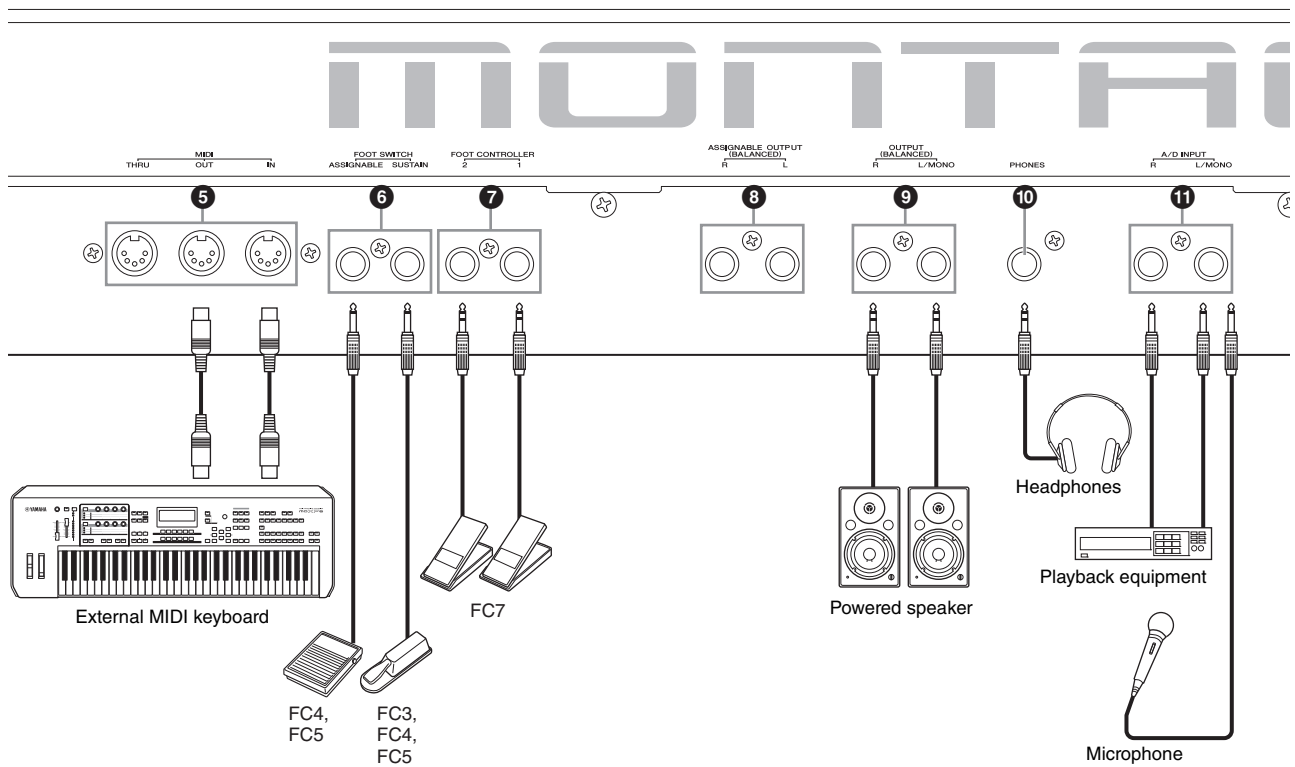

Jack List (Pin Alignment)

| Input and Output Jacks | Polarities | Balanced/Unbalanced | Configurations |
|--|--|---------------------|--------------------|
| 8 ASSIGNABLE OUTPUT (BALANCED) [L], [R]* 9 OUTPUT (BALANCED) [L/MONO], [R]* | Tip: Hot (+) Ring: Cold (-) Sleeve: Ground | Balanced | TRS phone plug |
| 10 [PHONES] | Tip: L Ring: R Sleeve: Ground | — | |
| 11 A/D INPUT [L/MONO], [R] | Tip: Signal Sleeve: Ground | Unbalanced | TS phone plug |

* These jacks are also compatible with TS phone plugs; when used, the connection is unbalanced.

■ Left side of Rear Panel

① [STANDBY/ON] switch

Press to set the power to On or Standby.

② [AC IN] (AC Power Cord Socket)

Plug the AC power cord supplied with this instrument.

③ [USB TO DEVICE] terminal

Used to connect this instrument to a USB flash memory device. This lets you save data created on this instrument to an external USB flash memory device and load data from a USB flash memory device to the instrument. Save/Load operations can be performed: [UTILITY] → [Contents] → [Store/Save] or [Load].

NOTE

- Only USB flash memory devices can be recognized by this instrument. No other USB devices (such as a hard disk drive, CD-ROM drive and USB hub) can be used.
- The instrument supports the USB 1.1 to 3.0 standard. However, note that the transfer speed differs depending on the data type and the condition of this instrument.

④ [USB TO HOST] terminal

Used to connect this instrument to a computer via a USB cable, and allows you to transfer MIDI data and audio data between the devices. Unlike MIDI, USB can handle multiple ports via a single cable (page 50). For information about how the MONTAGE handles Ports, see page 50.

NOTE

Audio data sending capability for the instrument is a maximum 32 channels (16 stereo channels) at a sampling frequency of 44.1 KHz; or maximum 8 channels (4 stereo channels) for a sampling frequency of 44.1 KHz to 192 KHz. Audio data receiving capability is a maximum 6 channels (3 stereo channels).

■ Right side of Rear Panel

⑤ MIDI [IN], [OUT], [THRU] terminal

MIDI [IN] is for receiving control or performance data from another MIDI device, such as an external sequencer, letting you control this instrument from the connected separate MIDI device.

MIDI [OUT] is for transmitting all control, performance and playback data from this instrument to another MIDI device, such as an external sequencer.

MIDI [THRU] is simply for redirecting any received MIDI data (via MIDI [IN]) to connected devices, allowing convenient chaining of additional MIDI instruments.

⑥ FOOT SWITCH [ASSIGNABLE]/[SUSTAIN] jacks

For connection of an optional FC3/FC4/FC5 Footswitch to the [SUSTAIN] jack and a FC4/FC5 Footswitch to the [ASSIGNABLE] jack. When connected to the [SUSTAIN] jack, the Footswitch controls sustain. When connected to [ASSIGNABLE], it can control one of various assignable functions.

NOTE

- The term "FC3" in this Owner's Manual refers collectively to the FC3 and other footswitches compatible with the FC3, such as the FC3A.
- The term "FC4" in this Owner's Manual refers collectively to the FC4 and other footswitches compatible with the FC4 such as the FC4A.

⑦ FOOT CONTROLLER [1]/[2] jacks

For connection of an optional foot controller (FC7, etc.). This jack lets you continuously control one of various different assignable functions for Part edit—such as volume, tone, pitch, or other aspects of the sound (see the Reference Manual PDF document).

⑧ ASSIGNABLE OUTPUT (BALANCED) [L] and [R] jacks (TRS balanced output)

Line level audio signals are output from this instrument via these TRS balanced outputs. These outputs are independent of the main output (at the OUTPUT [L/MONO]/[R] jacks below), and can be freely assigned to any of the Drum Part keys or the Parts. This lets you route specific Parts or sounds for processing with a favorite external effect unit. The Parts which can be assigned to these jacks are as follows:

- Drum Part key to which the drum/percussion instrument is assigned
- Metronome (Click)
- Any Part of a Performance*

* Includes Audio Input Part

For details, see the Reference Manual PDF document.

⑨ OUTPUT (BALANCED) [L/MONO] and [R] jacks (TRS balanced output)

Line level audio signals are output via these TRS balanced outputs. For monophonic output, use only the [L/MONO] jack.

⑩ [PHONES] (Headphone) jack

This standard stereo phones jack is for connection to a set of stereo headphones. This jack outputs audio signals identical to those from the OUTPUT [L/MONO] and [R] jacks.

⑪ A/D INPUT [L/MONO]/[R] jacks

External audio signals can be input via these phone jacks (1/4" mono phone plug). Various devices such as a microphone, CD player or synthesizer can be connected to these jacks and their audio input signal can be sounded as the Audio Part.

In addition, you can use the special Vocoder feature by connecting a microphone to this [L/MONO] jack and inputting your Voice to the microphone.

You can also use the Envelope Follower and ABS (Audio Beat Sync) features. Envelope Follower is a function for detecting the volume envelope of the input signal waveform and modifying sounds dynamically.

NOTE

- A guitar or bass having active pickups can be directly connected. However, when using passive pickups, connect the instrument via an effect device.
- The Vocoder/Envelope Follower can be controlled from all Part outputs, and not just the A/D INPUT [L/MONO]/[R] jack.

ABS (Audio Beat Sync) is a function for detecting the beat of the audio signal input from these jacks and synchronizing the beat with the Motion Sequencer or Arpeggio.

Use 1/4" mono phone plugs. For stereo signals (such as from audio equipment), use the [L/MONO]/[R] jacks. For mono signals (such as from a microphone or guitar), use only the [L/MONO] jack.

For details about the Envelope Follower and ABS features, see the Reference Manual PDF document.

Setting Up

Power Supply

Connect the supplied AC power cord in the following order. Make sure the [STANDBY/ON] switch on the instrument is set to the Standby position.

- 1 Connect the supplied power cord to the AC IN on the instrument's rear panel.
- 2 Connect the other end of the power cord to an AC outlet.

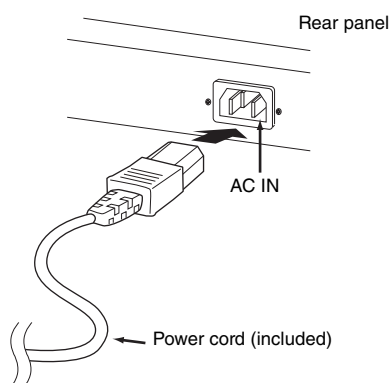

NOTE

Follow this procedure in reverse order when disconnecting the power cord.



WARNING

- Use only the AC power cord supplied with your instrument. The use of an inappropriate replacement can lead to overheating or electric shock.
- The power cord supplied with your instrument must not be used with other electrical equipment. Failure to observe this precaution can result in the equipment being damaged or cause a fire.
- Make sure your instrument the voltage requirement for the country or region in which it is being used.



CAUTION

The instrument remains charged and draws a small amount of power even when the [STANDBY/ON] switch is set to the Standby position. If you intend not to use it for an extended period of time, therefore, make sure to unplug the power cord from the wall outlet.

Connecting Speakers or Headphones

Since the instrument has no built-in speakers, you will need to monitor the sound of the instrument by using external equipment. Connect a set of headphones, powered speakers, or other playback equipment as illustrated below. When making connections, be sure that your cables have the appropriate ratings.

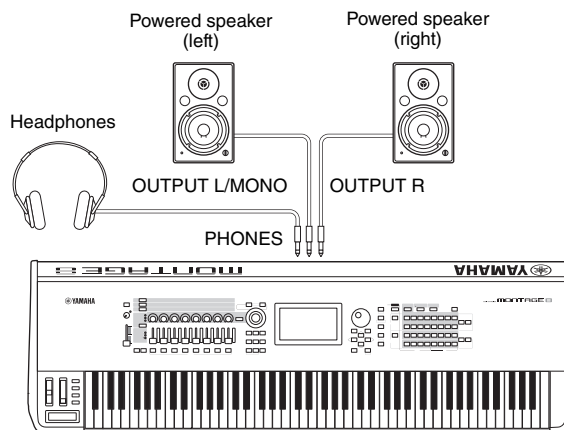

Powering Up the System

Make sure the volume settings of the instrument and external devices such as powered speakers are turned to the minimum before turning the power on. When connecting the instrument to powered speakers, turn on the power switch of each device in the following order.

When turning the power on:

First, the instrument (the display will turn on and the buttons will light), then the connected powered speakers.

When turning the power off:

First, the connected powered speakers, then the instrument (the display will turn off and the buttons will turn off).

Keep in mind that the [STANDBY/ON] switch is located at the right side (from the view of the keyboard) of the AC IN socket on the rear panel of the instrument.

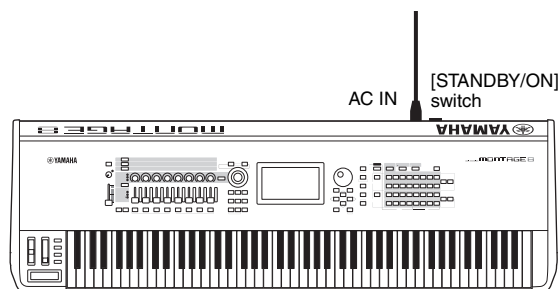

Auto Power Off function

To prevent unnecessary power consumption, this instrument features an Auto Power Off function that automatically turns the power off if the instrument is not operated for a specified period of time.

Auto Power Off Setting

The amount of time that elapses before the power is automatically turned off can be set.

| | |
|-------------------------|---|
| Instructions: | [UTILITY] → [Settings] → [System] → [Auto Power Off] |
| Setting Value (min.): | Off (disables Auto Power Off), 5, 10, 15, 30, 60, 120 |
| Default Setting (min.): | 30 |

Disabling Auto Power Off (simple method)

Turn the power on while holding down the lowest key on the keyboard. An “Auto power off disabled” message appears briefly and Auto Power Off is disabled. The setting is retained even if the power is turned off.

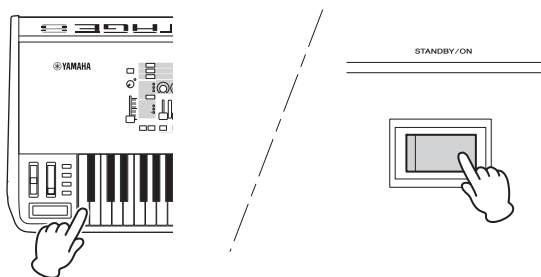

NOTICE

- Even when the power is turned off, electricity is still flowing to the instrument at the minimum level. To shut off the electricity completely, make sure you unplug the power cord from the wall AC outlet.
- Depending on the instrument status, the power may not turn off automatically, even after the elapse of the specified period of time. Always turn off the power manually when the instrument is not in use.
- When the instrument is not operated for a specified period of time while connected to an external device such as an amplifier, speaker or computer, make sure to follow the instructions in the Owner's Manual to turn off the power to the instrument and the connected devices in the proper sequence, in order to protect the devices from damage. If you do not want the power to turn off automatically when a device is connected, disable Auto Power Off.
- The setting will revert to its default value if not backed up before the power is turned off.
- When Auto Power Off is set to “off,” the value will be retained even if the backup data saved on another device is loaded to the instrument. When Auto Power Off is set to something other than “off,” the value will be overwritten with loaded data.

NOTE

- The setting time is approximate.
- To turn the power on after Auto Power Off has been executed, press the [STANDBY/ON] switch.
- When the factory settings are restored, the setting time is changed to the default value (30 min.).

Adjusting the Master Volume output

Adjust the overall level of this instrument by using the [MASTER VOLUME] slider.

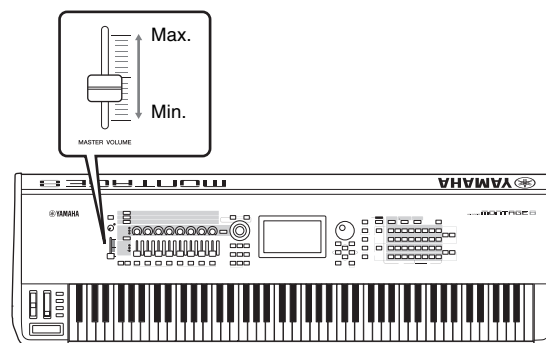

CAUTION

Do not listen with the headphones at high volume for long periods of time. Doing so may cause hearing loss.

Restoring the initial factory settings (Initialize All Data)

NOTICE

When the Initialize All Data operation is executed, all the Performance, Song, and any system settings you created on the Utility display will be erased. Make sure you are not overwriting any important data. Be sure to save all important data to your USB flash memory device before executing this procedure (page 53).

- 1 Press the [UTILITY] button or touch the UTILITY icon in the upper right of the screen to call up the Utility display.
- 2 Touch the [Settings] tab in the left of the screen and then touch the [System] tab. The entire system setting display appears.
- 3 Touch [Initialize All Data] in the lower right of the screen. The display prompts you for confirmation. To cancel this operation, touch the [Cancel No] in the screen or press the [DEC/NO] button on the panel.
- 4 Touch [Yes] in the screen or press the [INC/YES] button to execute the Initialize All Data operation.

Basic Operation and Displays

The MONTAGE features a convenient touch panel display. You can operate various settings and select desired parameters by directly touching the screen. Furthermore, you can use the data dial and other buttons for display operations.

Display (touch panel) configuration

This section explains the navigation bar and the display selecting tabs which are common to all types of displays. For the purpose of illustration, the Live Set display which appears when the MONTAGE is turned on and the Performance Play display (Home) are used as examples.

NOTE

You can change the start-up display (the display that first appears when the power is turned on). For details about the setting, see page 45.

Live Set display

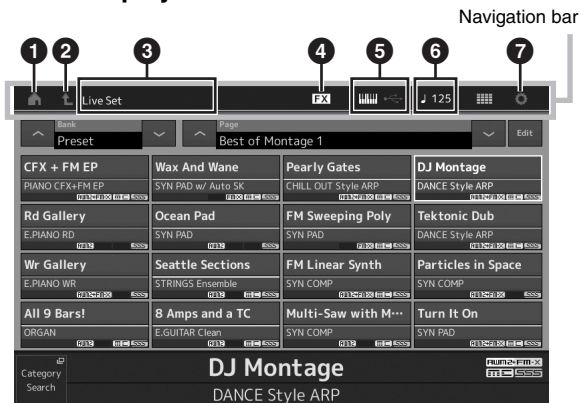

1 HOME icon

Moves to the Performance Play display.

2 EXIT icon

Functions same as the [EXIT] button on the panel. Press this icon to exit from the current display and return to the previous level in the hierarchy.

3 INFORMATION area

Displays helpful information, including the currently selected display name.

4 EFFECT icon

Touch the icon to call up the Effect switch display. The icon turns off when any of the Effect blocks (Insertion, System or Master) is off.

5 QUICK SETUP icon

Displays the settings of Local Control ON/OFF and MIDI IN/OUT.

The keyboard-shaped icon lights up when Local Control is set to ON and turns off when Local Control is set to OFF.

When MIDI is set as the MIDI IN/OUT setting, a MIDI connector-shaped icon appears. When USB is set as the MIDI IN/OUT setting, a USB connector-shaped icon appears.

Touch the desired icon to call up the corresponding quick setup display.

6 TEMPO SETTING icon

Displays the tempo of the currently selected Performance. Touch the icon to call up the Tempo setting display.

7 UTILITY icon

Touch the icon to call up the last opened display among the Utility displays.

Performance Play display



8 LIVE SET icon

Touch the icon to call up the Live Set display.

9 Display selecting tabs

Touch the desired tab to call up the corresponding display.

Moving the cursor

Use these four buttons to navigate the display, moving the cursor around the various selectable items and parameters in the screen. When selected, the relevant item is highlighted (the cursor appears as a dark block with inverse characters). You can change the value of the item (parameter) at which the cursor is located by using the data dial, [INC/YES] and [DEC/NO] buttons.

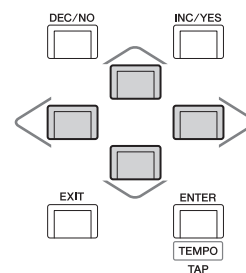

Changing (editing) parameter values

Rotating the Data dial to the right (clockwise) increases the value, while rotating it to the left (counter-clockwise) decreases it.

Pressing the [INC/YES] button increases a parameter value by one step, and pressing [DEC/NO] button decreases it. For parameters with large value ranges, you can increase the value by 10 by simultaneously holding down the [SHIFT] button and pressing the [INC/YES] button. To decrease by 10, simultaneously hold down the [SHIFT] button and press the [DEC/NO] button.

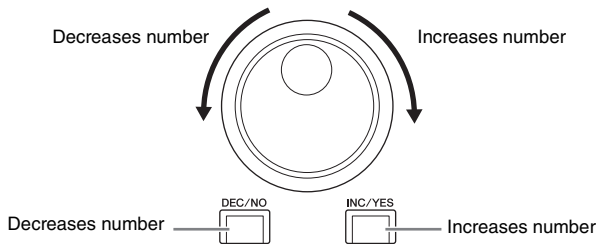

Naming (inputting characters)

You can freely name the data you've created, such as Performances, Songs, and files saved to a USB storage device. Touch the Naming parameter or move the cursor to the Naming parameter and press the [ENTER] button to call up the input character display.

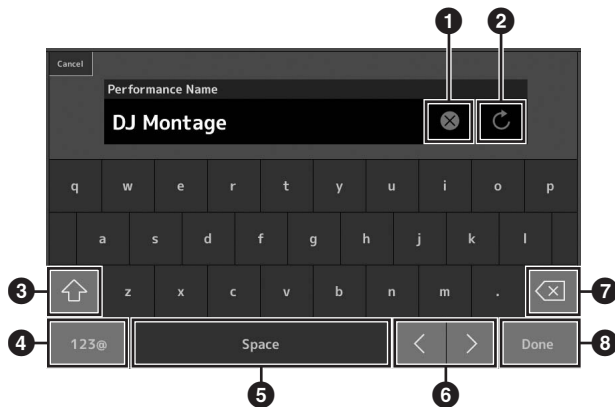

- 1 Deletes all characters.
- 2 Reverts to the default name.
- 3 Switches between uppercase and lowercase alphabetical characters.
- 4 Calls up the display for entering numbers, punctuation marks and miscellaneous characters.
- 5 Inserts a space (blank) at the cursor position. (You can also use the [INC/YES] button for the same operation.)
- 6 Moves the cursor position.
- 7 Deletes the previous character (backspace). (You can also use the [DEC/NO] button for the same operation.)
- 8 Completes the text input and closes the display.

Inputting using the keys on the keyboard and numeric keypad display

For some parameters, you can also enter the value directly, using the LCD display as a numeric keypad or using keys on the keyboard. Input via the keys can be activated when inputting parameters relating to note and velocity. Input via the numeric keypad display can be activated when inputting velocity-related parameters. Touch the desired parameter or move the cursor to the parameter and press the [ENTER] button to call up the display having the two input tabs (shown below).

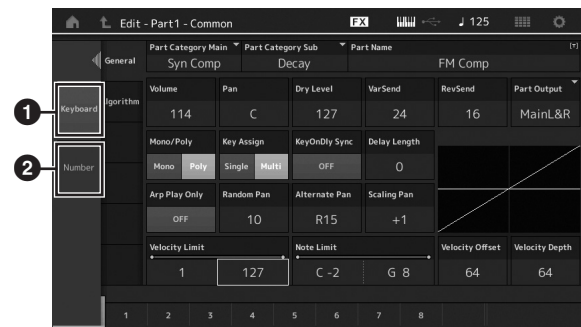

- 1 Enables keyboard input.
You can play any note on the keyboard and the note or velocity are input.
- 2 Enables numeric keypad input.
You can input a number directly by using the numeric keypad. You can also use the data dial, the [INC/YES] button, and the [DEC/NO] button to increase and decrease the input number.

Numeric keypad display

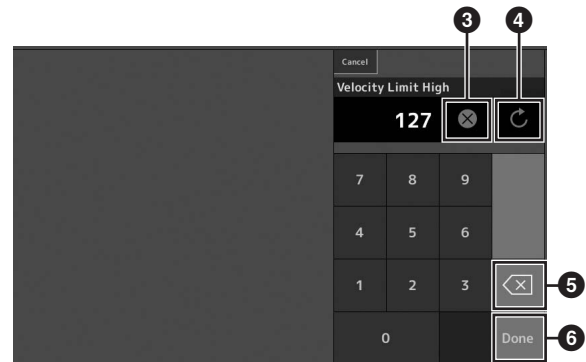

- 3 Erases all numbers.
- 4 Restores the value to the last setting.
- 5 Deletes the last digit of the number.
- 6 Completes the input operation and closes the numeric keypad display.

Quick Guide — Selecting Performances

The MONTAGE has 16 Parts and basic musical instrument sounds are assigned to each Part. A single set of these sounds is called a “Performance.” You can change sounds as desired by selecting the appropriate Performance.

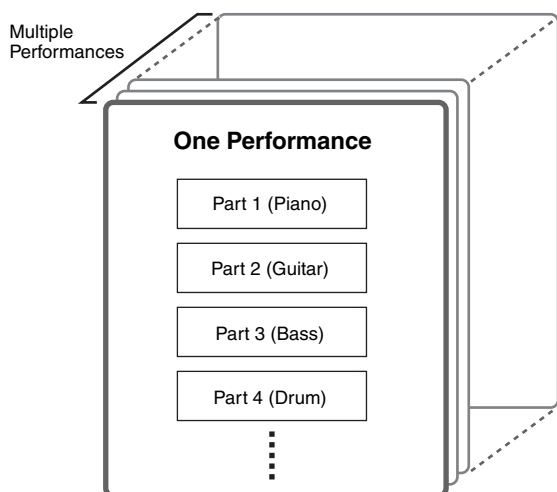

There are three Part types as follows.

Normal Parts (AWM2)

Normal Parts (AWM2) are mainly pitched musical instrument type sounds (piano, organ, guitar, synthesizer, etc.) that can be played over the full range of the keyboard.

Normal Parts (FM-X)

Normal Parts (FM-X) are powerful FM Synthesis system sounds. This sound is played conventionally from the keyboard, with standard pitches sounding for each key.

Drum Parts

Drum Parts are mainly percussion/drum sounds that are assigned to individual notes.

Performances can also be divided into two groups as follows.

Single Part Performances

A Single Part Performance contains only one Part. Select this if you want to play a single instrument.

Multi Part Performances

A Multi Part Performance contains multiple Parts. Select this if you want to play sounds of multiple instruments by using layering and splitting functions.

This instrument features Banks for memorizing Performances. There are basically four different types of Banks: Preset, User, Library, and GM. The contained Performances and features depend on the Bank as described below.

Preset Banks

The Preset Banks contain a full set of specially programmed Performances. Performances you've edited yourself cannot be saved in the Preset Banks.

User Banks

The User Banks contain the Performances you have edited and stored. The User Banks are initially empty.

NOTICE

If a Performance in a User Bank (User Performance) is overwritten or replaced, that User Performance will be lost. When you store an edited Performance, be careful not to overwrite any important User Performances.

Library Banks

The Library Banks contain the Performances you have added as Libraries. The Library Banks are initially empty. (A Library can be added by importing a library file.)

GM Bank

The GM Bank contains the Parts allocated according to the GM standard.

GM

GM (General MIDI) is a worldwide standard for Voice organization and MIDI functions of synthesizers and tone generators. It was designed primarily to ensure that any song data created with a specific GM device would sound virtually the same on any other GM device—no matter the manufacturer or the model. The GM bank on this synthesizer is designed to appropriately play back GM song data. However, keep in mind that the sound may not be exactly the same as played by the original tone generator.

Each of these Banks include Performances organized according to the Performance type.

NOTE

- For details about Performances, refer to “Basic Structure” in the Reference Manual PDF document.
- For lists of the Performances, refer to the separate Data List PDF.

When you turn on your instrument for the first time, a Live Set of the Preset Banks will be displayed in the top display. The Live Set is a list in which Performances can be freely arranged. Up to 16 Performances can be arranged over a single page. You can play various Performances selected from the Preset Live Sets.

Selecting a Performance from the Live Set

1 Press the [LIVE SET] button.

This calls up the Live Set display.

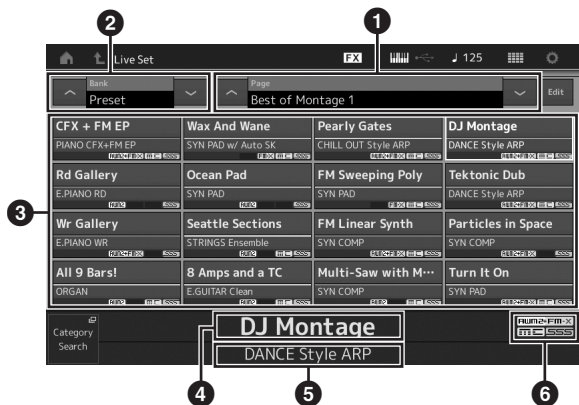

- 1 Page (Switched by pressing [Λ] [V] in the screen, the ELEMENT/OPERATOR [MUTE] button, or the [SOLO] button. Selected by pressing the Number A [5] – [8]/[13] – [16] buttons, the Number B [5] – [8] buttons, or the Number C [5] – [8] buttons.)
- 2 Preset Bank/User Bank (switched by pressing the [Λ] [V] in the screen, the PART [MUTE] button, or the [SOLO] button)
- 3 Performance list
- 4 Active Performance names
- 5 Slot name
- 6 Flag (see chart below)

| Flag | Definition |
|-----------|---|
| AWM2 | Performance comprised only of AWM2 Parts |
| FM-X | Performance comprised only of FM-X Parts |
| FM-X+AWM2 | Performance comprised of both AWM2 and FM-X Parts |
| MC | Performance featuring Motion Control |
| SSS | Performance featuring Seamless Sound Switching |

NOTE

“Seamless Sound Switching” is a feature that lets you switch Performances smoothly without any notes being cut off. The SSS feature is available for all Preset Bank Performances in this instrument. However, SSS is available only for the Performance containing Parts 1 – 8, not for the Performance with using Parts 9 – 16.

2 Touch the desired Performance on the screen.

NOTE

- You can select a Performance by pressing the Number A [1] – [4] and [9] – [12] buttons, the Number B [1] – [4] buttons, or the Number C [1] – [4] buttons.
- To arrange the order of the Performances registered in the Live Set, see page 30.

3 Play the keyboard.

Switching Performances

1 Press the [PERFORMANCE] button.

The Performance Play display appears, and the current Performance name is shown.



2 Move the cursor to the Performance name and select the desired Performance by using the data dial, the [INC/YES] button, or the [DEC/NO] button.

NOTE

- To quickly move forward through the Performance numbers in 10-step jumps, simultaneously hold down the [SHIFT] button and press the [INC/YES] button.
- To decrease by 10, do the opposite; simultaneously hold down the [SHIFT] button and press the [DEC/NO] button.

3 Play the keyboard.

Using the Category Search function

The Performances are conveniently divided into specific Categories, irrespective of their bank locations. The categories are divided based on the general instrument type or sound characteristics. The Category Search function gives you quick access to the sounds you want.

1 Press the [CATEGORY SEARCH] button while the Performance Play display is shown.

This calls up the Category Search display.

NOTE

You can open the Category Search display by selecting [Search] from the menu that is called up when the Performance name is touched.

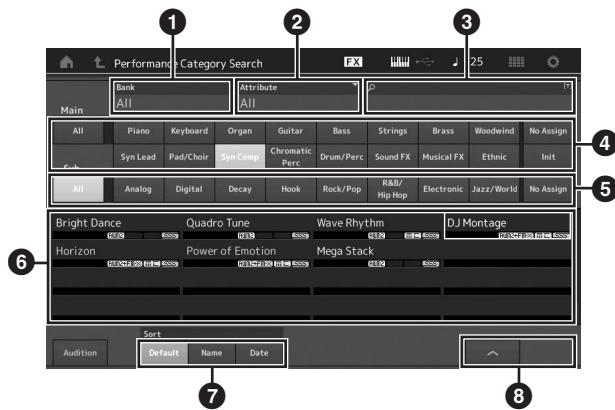

1 Bank

2 Attribute

NOTE

Attributes are Performance properties and sorted according to tone generator types or parts of Performances.

3 Keyword search

4 Main categories

5 Sub categories

6 Performance list of the selected category

NOTE

The selected Performance is displayed in white, Performances with a single part are in green, and Performances with multi parts are in blue.

7 For changing the sorting order

8 For changing the Performance list page

2 Touch and select the desired main category (4).

NOTE

- You can filter the Performance lists by touching [Bank] (1) and selecting the desired bank type from the list.
- You can also filter the Performance lists by touching [Attribute] (2) and selecting the desired attribute type from the list.
- You can also select the desired main category by using the Number A [1] – [16] buttons.

3 Touch and select the desired sub category (5).

This calls up the Performance lists of the selected category (6).

NOTE

You can also select the desired sub category by using the Number B [1] – [8] buttons.

4 Touch the desired Performance.

NOTE

You can also select the desired Performance by using the Number C [1] – [8] buttons.

5 Touch the HOME icon or EXIT icon to actually call up the selected Performance.

This closes the Category Search display.

NOTE

You can also use the [ENTER] button, the [EXIT] button, or the [PERFORMANCE] button to finalize the selection.

Below is a list of the Categories and their panel abbreviations.

| Abbreviation | Category |
|----------------|--|
| Piano | Piano |
| Keyboard | Keyboard instruments (Harpsichord, Clav, etc.) |
| Organ | Organ |
| Guitar | Guitar |
| Bass | Bass |
| Strings | Strings |
| Brass | Brass |
| Woodwind | Woodwind instruments |
| Syn Lead | Synth Lead |
| Pad/Choir | Synth Pad |
| Syn Comp | Synth Comp |
| Chromatic Perc | Chromatic Percussion (Marimba, Glockenspiel, etc.) |
| Drum/Perc | Drum/Percussion |
| Sound FX | Sound Effect |
| Musical FX | Musical Effect |
| Ethnic | Ethnic |
| No Assign | No Assign |
| Init | Initialize |

6 Play the keyboard.

Selecting an Initialized Performance

Follow the steps below to select an Initialized Performance.

- 1 Touch [Init] of the main category in the Category Search display.
- 2 Only initialized Performances are displayed in the Performance list.

The Initialized Performances are divided into three categories: [Initialized Perform] for the normal Parts (AWM2), [Initialized FM] for the normal Parts (FM-X), and [Initialized Drum] for the Drum Parts.

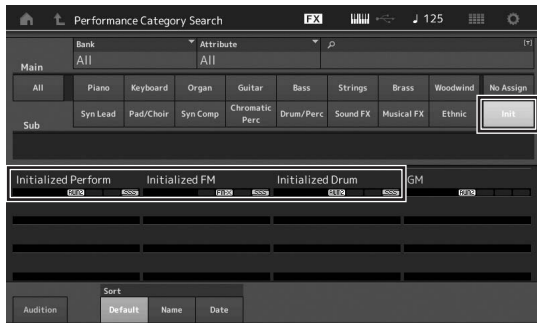

- 3 Select the desired Performance.

Selecting only Single Part Performances

You can filter out the Single Part Performances by using the Attribute function.

- 1 Touch [Attribute] in the Category Search display.
- 2 Touch [Single] from the menu in the left of the screen.

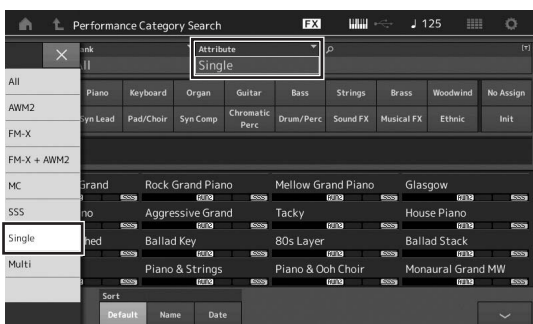

- 3 Only Single Part Performances are displayed in the Performance list, letting you select the desired one.

Playback Audition phrase

You can hear a sample of Performance sounds. The sample sound is referred to as "Audition phrase."

- 1 Touch [Audition] in the Category Search display.

The sample of the currently selected Performance plays.

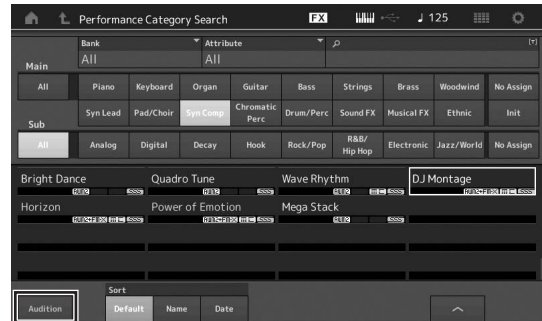

[Audition]

If you select a different Performance during Audition phrase playback, the audition phrase switches to that of the newly selected Performance.

- 2 Touch [Audition] again to stop playback.

NOTE

- You can also playback/stop the Audition phrase by pressing the [AUDITION] button on the front panel.
- You can playback/stop the Audition phrase by pressing the [AUDITION] button on the front panel while the Performance display or the Live Set display is shown.

Quick Guide — Playing the Keyboard

You can mix several different parts together in a layer, or split them across the keyboard, or even set up a combination layer/split. Each Performance can contain up to eight different Parts. Press the [PERFORMANCE] button before playing the keyboard.

Performance Play display

In this condition, playing the keyboard sounds the Performance indicated in the display. The parameters shown in the Performance Play display are briefly explained below. You can operate the icons by touching on the display.



- 1 Performance name
- 2 Flag
- 3 Functions assigned to knobs
- 4 Part names
- 5 Switching Motion Sequencer on/off for Parts
- 6 Switching Arpeggio on/off for Parts
- 7 Note Limit for Parts
- 8 Switching Keyboard Control on/off for Parts
- 9 Switching Mute on/off for Parts
- 10 Switching Solo on/off for Parts
- 11 Volume of Parts 1 – 8
- 12 Meter (Audio Output Level)

Switching a Part on/off

You can turn the eight Parts of the current Performance on or off as desired.

Turning specific Parts on/off (Mute function)

You can turn individual Parts on/off by using the Mute function.

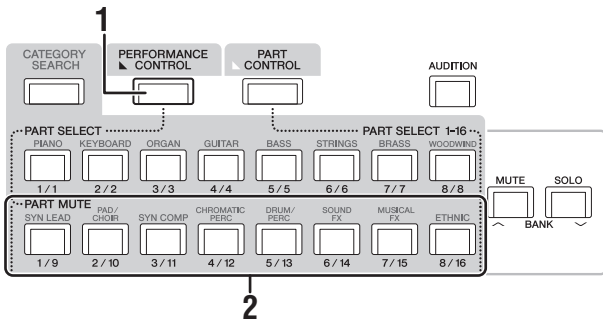

1 Press the [PERFORMANCE CONTROL] button.

The button lamp lights, indicating that each Part can be turned on/off.

2 Press any of the Number A [9] – [16] buttons. The corresponding buttons [1] – [8] of the pressed button will light dimly and the Part will be muted.

Press the same button again to turn the button on and disengage the mute function for that Part. You can turn multiple Parts on/off by pressing their buttons.

You can also mute parts by using the [PART CONTROL] button with the operation below.

1 Press the [PART CONTROL] button.

2 Press the [MUTE] button to turn the button on.

Among the Number A [1] – [16] buttons, only the buttons whose corresponding Parts have sounds assigned to them will light.

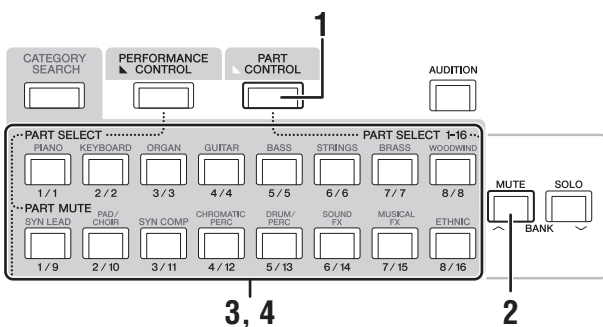

3 Press the desired Number A [1] – [16] button to mute the corresponding Part. The pressed button will change from fully lit to dimly lit.

You can turn multiple Parts on/off by pressing multiple buttons.

4 Press any of the dimly lit Number A [1] – [16] buttons. The pressed button will fully light again and the Mute function for that Part will be disengaged.

Soloing a specific Part

The Solo function is the opposite of Mute, and lets you instantly solo a specific Part and mute all others.

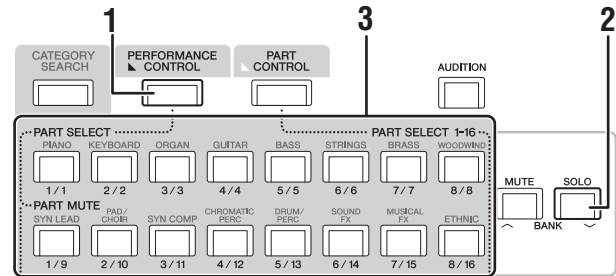

1 Press the [PERFORMANCE CONTROL] button.

2 Press the [SOLO] button.

The [SOLO] button lights, indicating that Solo is enabled.

3 Press any of the Number A [1] – [8] / [9] – [16] buttons.

The pressed button will light and only the corresponding Part among the Parts 1 – 8 will be sounded. (The Number A [1] – [8] and [9] – [16] buttons work in conjunction with each other.)

You can also solo a part by using the [PART CONTROL] button with the operation below.

1 Press the [PART CONTROL] button.

2 Press the [SOLO] button to turn the button on.

Among the Number A [1] – [16] buttons, only the buttons whose corresponding Parts have sounds assigned to them will light dimly.

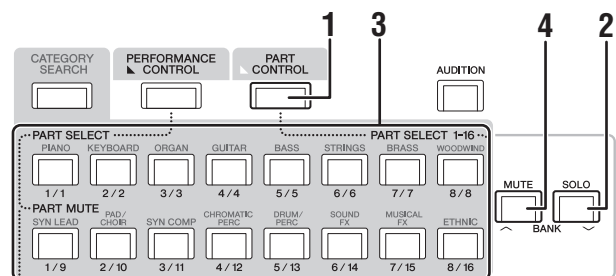

3 Press any of the Number A [1] – [16] buttons to solo the corresponding Part. The pressed button will change from being dimly lit to fully lit.

You can change the solo Part by pressing any other Number button.

4 Press the [MUTE] button to disengage the Solo function.

Using the Arpeggio function

This function lets you trigger rhythm patterns, riffs and phrases using the current Part by simply playing notes on the keyboard.

It not only provides inspiration and full rhythmic passages in your live performances, but it gives you fully formed instrumental backing parts of various music genres for ease in creating songs.

You can assign the desired eight Arpeggio Types to each Part and play back the Arpeggios of up to eight Parts simultaneously.

You can also set the Arpeggio playback method, Note range, Velocity range and Play Effects to create your own original grooves.

NOTE

For details about Arpeggio, see the Reference Manual PDF document.

Turning the Arpeggio on/off

To turn Arpeggio playback on or off, press the [ARP ON/OFF] button on the panel.

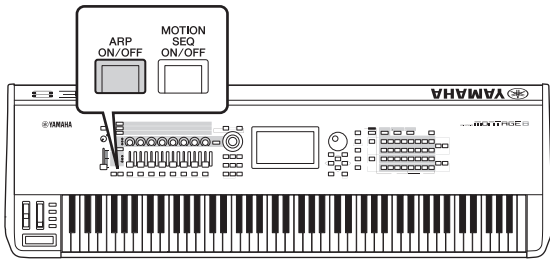

Changing the Arpeggio type

You can change the Arpeggio type by pressing the Number C [1] – [8] buttons as desired.

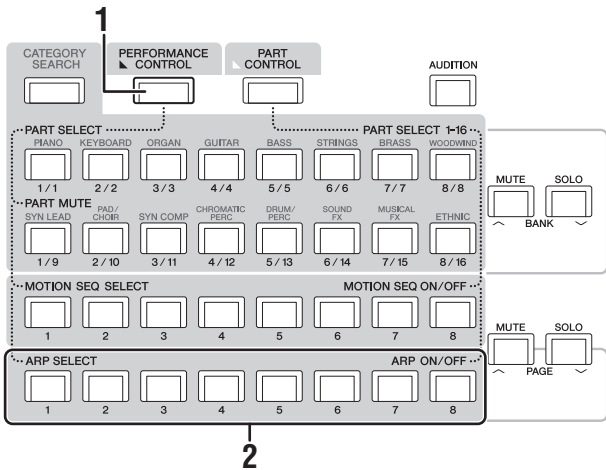

1 Press the [PERFORMANCE CONTROL] button.

The [PERFORMANCE CONTROL] button lights, indicating that Arpeggios can be selected by using the Number C [1] – [8] buttons.

2 Press any of the Number C [1] – [8] buttons to change the Arpeggio Type.

NOTE

For information on setting the Arpeggio Type, refer to page 37.

Turning Arpeggio playback on/off for each Part

You can turn Arpeggio playback on or off for eight Parts of the Performance as described below.

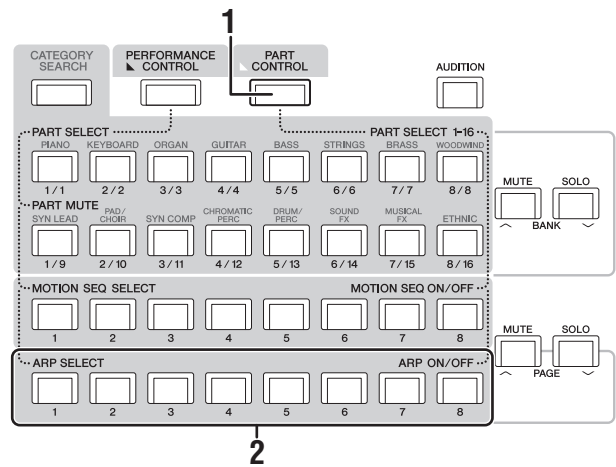

1 Press the [PART CONTROL] button.

The [PART CONTROL] button lights, indicating that Arpeggio playback for each Part can be turned on/off by using the Number C [1] – [8] buttons.

2 Pressing each of the Number C [1] – [8] buttons toggles Arpeggio playback on and off for each Part.

When Arpeggio playback is turned on, the corresponding button fully lights, and when turned off, the button lights dimly.

NOTE

You can turn Arpeggio playback on/off for each part by touching the [ARP ON/OFF] button on the display as well.

Using the Motion Sequencer function

The powerful Motion Sequencer feature lets you dynamically change sounds by operating Parameters depending on sequences created in advance.

It provides real time control for changing sounds depending on various sequences such as Tempo, Arpeggio, or the rhythm of external connected devices.

You can assign up to eight desired Sequence types for one Lane.

You can also set up to four Lanes corresponding to the Motion Sequencer function for one Part. Up to eight Lanes can be used at the same time for the entire Performance.

For the Motion Sequencer function, in addition to being able to set the Arpeggio playback method, you can also set the Velocity range, Play Effects, the amount of steps, and so on, to create your own original grooves.

NOTE

For details about the Motion Sequencer, see the Reference Manual PDF document.

Turning Motion Sequencer on/off

Press the [MOTION SEQ ON/OFF] button on the front panel to turn the Motion Sequencer on/off.

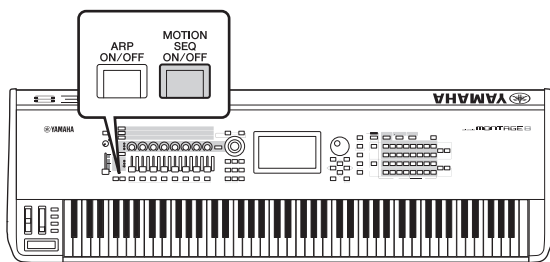

Changing Motion Sequences

Press the Number B [1] – [8] buttons to switch among the Motion Sequence types.

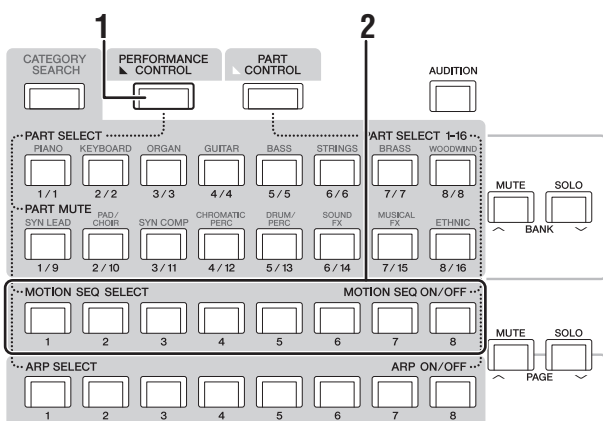

1 Press the [PERFORMANCE CONTROL] button.

The [PERFORMANCE CONTROL] button lights, indicating you can select the Motion Sequence types by using the Number B [1] – [8] buttons.

2 Press the Number B [1] – [8] buttons to change the Motion Sequences.

Select the desired Motion Sequence type assigned to each Number B button.

NOTE

For details about Motion Sequence edit, see the Reference Manual PDF document.

Turning Motion Sequencer on/off for each Part

Motion Sequencer can be turned on/off for each Part as follows.

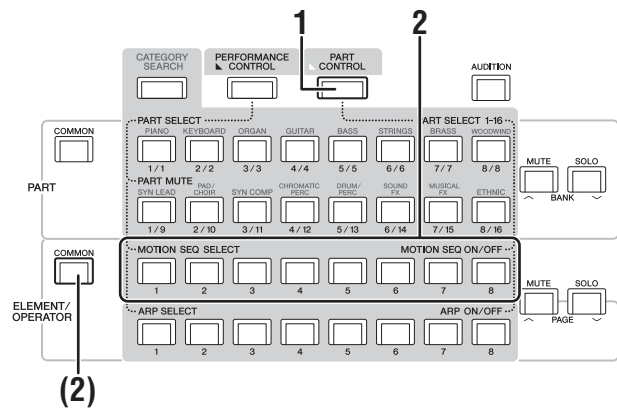

1 Press the [PART CONTROL] button.

The [PART CONTROL] lights, indicating that you can turn the Motion Sequencer on/off for each Part by using the Number B [1] – [8] buttons. In this condition, you can turn the common Motion Sequencer on/off by using the corresponding ELEMENT/OPERATOR [COMMON] buttons.

2 Press the Number B [1] – [8] buttons to turn Motion Sequencer on/off.

When Motion Sequencer is on, the corresponding button fully lights; when off, the corresponding button lights dimly. When all Lanes for the Part are in off status, the corresponding button lamp is off and is not active for this operation.

NOTE

You can also touch the [MS ON/OFF] on the screen to perform the same operation.

To turn the common Motion Sequencer on/off, press the ELEMENT/OPERATOR [COMMON] button.

When Motion Sequencer is on, the corresponding button fully lights; when off, the corresponding button lights dimly. When all Lanes for the Part are in off status, the corresponding button lamp is off and is not active for this operation.

NOTE

You can also touch [MS Cmm] on the screen to perform the same operation.

Using controllers to change the sound

The MONTAGE gives you an amazing amount of control options. In addition to the conventional Pitch Bend and Modulation Wheels, it also features an extensive array of special real time controls—including the Knobs, Super Knob, Sliders, Ribbon Controller and Assignable Switch buttons.

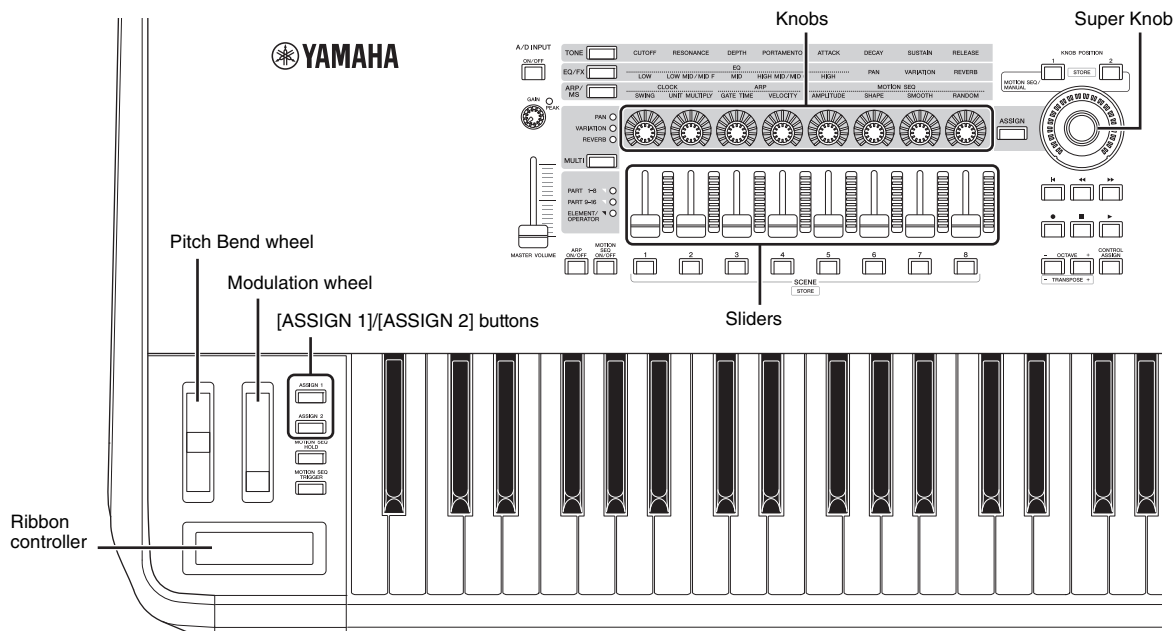

Using the Knobs to change the sound

Knobs 1 – 8 let you adjust a variety of parameters for the current Performance or Part, such as effect depth, attack/release characteristics, timbre, and others. The functions assigned to each Knob can be alternatively selected via the Knob Function buttons, the Multi Part Control button, or the Assign buttons. There are basically two ways in which the sound can be controlled: controlling the entire Performance or controlling the specific Part.

■ For controlling the entire Performance

Move the cursor to the desired Performance name from the Performance Play display. Or turn the PART [COMMON] button on and operate Knobs 1 – 8.

■ For controlling the desired Part

Move the cursor to the desired Part name from the Performance Play display. Or turn on any of the Number A [1] – [8] buttons and operate Knobs 1 – 8.

1 Press the knob function [TONE]/[EQ/FX]/[ARP/MS] button or the Knob Assign [ASSIGN] button, so that the button corresponding to the function you want to switch is lit.

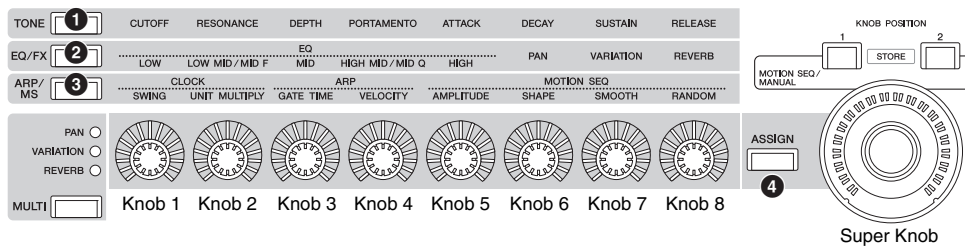

- ❶ [TONE]: Switches to functions related to sound settings
- ❷ [EQ/FX]: Switches to functions related to EQ and Effect settings
- ❸ [ARP/MS]: Switches to functions related to Arpeggio and Motion Sequencer settings
- ❹ [ASSIGN]: Switches to preset functions designed to bring out the best characteristics of each Performance

The functions currently assigned to the Knobs 1 – 8 and the parameter values of the functions are shown.



2 Turn a desired knob while playing the keyboard.

The value of the corresponding parameter changes and the function/effect is applied to the sound.

Using the Super Knob to change the sound

The Super Knob lets you simultaneously control all parameter values of the functions assigned to Knobs 1 – 8. You can create complex sounds by using the Super Knob together with the Motion Sequencer.

The Super Knob is always available for use. You don't have to press the Knob function button or the Knob Assign button before using the Super Knob.

This section covers the procedure to check the parameter values changed by the operation of the Super Knob.

1 Press the PART [COMMON] button.

The button lights, indicating that you can make common settings for all Parts.

2 Press the Knob Assign [ASSIGN] button to make the button light.

The functions currently assigned to Knobs 1 – 8 and the parameter values are shown.

3 Turn the Super Knob while playing the keyboard.

All relevant parameter values simultaneously change and all assigned functions are applied to the sound.

NOTE

For details about the Knob assignment and the Super Knob setting, see the Reference Manual PDF document.

Controlling the Super Knob by using a foot controller

You can control the Super Knob by using a foot controller (FC7).

- 1 Connect the foot controller (FC7) to the FOOT CONTROLLER [1]/[2] jack.
- 2 Move the cursor to the Performance name on the Performance Play display and then press the [EDIT] button.
- 3 Touch the [Control] tab in the left of the screen → [Control Number] tab.
- 4 Set “Foot Ctrl 1” or “Foot Ctrl 2” to “Super Knob”—depending on which jack you connected the foot controller (FC7).



Mixing

Each Mixing can contain up to 16 Parts and a separate Mixing can be created for each Part. You can adjust the various mixing related parameters for each Part: volume, pan, etc.

Basic procedure for Mixing

1 Touch the [Mixing] tab on the left side of the Performance Play display.

The Mixing display appears.



- 1 Main category for each Part
- 2 Switching displays between 3-band EQ / 2-band EQ
- 3 EQ setting for each Part
- 4 Parameter values for each Part
- 5 Changing the display for Parts 1 – 16
- 6 Changing the display for the audio Parts (Parts 9 – 16 are not displayed)

2 Press the [PART CONTROL] button → Number A [1] – [16] buttons to select the desired Part for which you want to adjust the parameter values.

NOTE

By touching [Audio] (6) on the screen, the audio Part are shown. You can set the parameters relating to the audio data (AD Part) input from the A/D INPUT [L/MONO]/[R] jack and the audio data (Digital Part)* input from the [USB TO HOST] terminal.

*The audio data which is set as “Digital L/R” among device ports

3 Move the cursor to the parameters for each Part and change the parameter values by turning the Data dial.

NOTE

- For more detailed parameter settings, press the [EDIT] button in the Mixing display to open the Edit display.
- For details about the Mixing parameters and Mixing Edit, see the Reference Manual PDF document.

Using the Scene function

You can store all parameter settings such as Arpeggio type, Motion Sequencer type, and the Part parameter values together as a “Scene.” There are eight Scenes and you can select them by pressing the [SCENE] button.

This is useful for simultaneously and drastically changing the Arpeggio type and the Motion Sequencer type while you are playing a single Performance.

Changing Scene settings

1 Touch the [Scene] tab on the left side of the Performance Play display.

The Scene display appears.

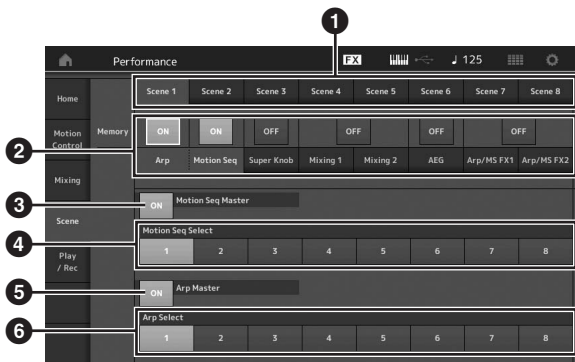

- 1 Switching among Scenes 1 – 8
- 2 Turning functions for each Scene on/off
- 3 Turning the Motion Sequencer for All Parts on/off
- 4 Motion Sequencer type of the currently selected Scene
- 5 Turning the Arpeggio for all Parts on/off
- 6 Arpeggio type of the currently selected Scene

NOTE

Sections 3 to 6 (see illustration above) are displayed only when “Arp” and “Motion Seq” are selected in section 2.

2 Set Scenes 1 – 8 as desired.

When [Memory] is turned on for the function, the Motion Sequencer type, or the Arpeggio type, the corresponding function information is automatically memorized to the currently selected [SCENE] button. By pressing one of the SCENE [1] – [8] buttons, the Scenes 1 – 8 are switched and stored information for each Scene is restored.

NOTE

You can also change Scene Settings from any other operation displays. To do this, press one of the SCENE [1] – [8] buttons while holding down the [SHIFT] button. Scenes 1 to 8 are assigned to each button.

3 Store the Performance as necessary (page 32).

NOTICE

If you select a different Performance or turn off the power without storing your edited Performance, all the edits you’ve made for the Scene will be erased.

Quick Guide — Creating Your Own Live Sets

The Live Set is ideal for live performance situations since it lets you instantly switch among desired Performances. You can create your own Live Set by simply grouping together your favorite Performances.

Registering a Performance to a Live Set

Follow the instructions below to store Performances to Live Sets.

NOTICE

- Before storing the currently editing Performance to the Live Set, store the Performance itself (page 32).
- If you select a different Performance or turn off the power without storing your edited Performance, all the edits you've made will be erased.

- 1 Select the Performance you want to use.
- 2 While any displays other than the Live Set display appear, hold down the [SHIFT] button and press the [LIVE SET] button. The Live Set display appears.
- 3 Touch one of the slots and press the [ENTER] button. The currently selected Performance will be registered in the slot.

NOTE

You can select the slot by using the Number A [1] – [4] and [9] – [12] buttons, the Number B [1] – [4] buttons, or the Number C [1] – [4] buttons.

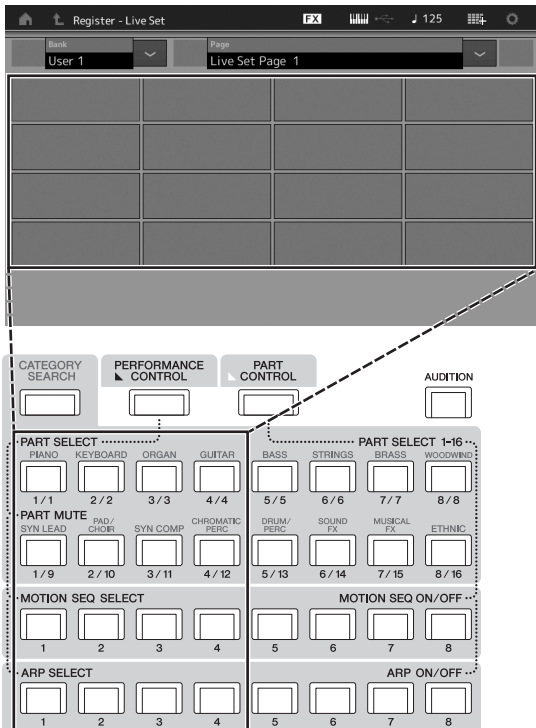

Live Set display

The performance registered in the slot An empty slot



Sorting registered Performances in a Live Set

You can change the order of the Performances registered to a Live Set on the Live Set Edit display.

- 1 Press the [EDIT] button while the Live Set display is shown.

The Live Set Edit display appears.

(The Live Set Edit display will not be shown if a Live Set of the preset bank/library bank is open.)

- 2 Select the slot containing the Performance you want to move and touch [Swap] on the screen.

The [Swap] lights up and now the slot can be changed.

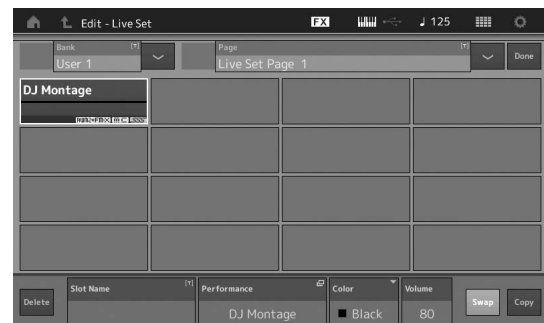

- 3 Select the desired destination slot.

The original slot and the destination slot are switched with each other.

Switching Performances stored in a Live Set by using the footswitch

You can switch the Performances by using a connected footswitch (FC4 or FC5). The setting for this operation is as follows.

- 1 Connect the footswitch (FC4 or FC5) to the FOOT SWITCH [ASSIGNABLE] jack.**
- 2 Press the [UTILITY] button to call up the Utility display, and then touch [Settings] tab → [MIDI I/O] tab at the left side of the screen.**
- 3 Set “FS Assign” to “Live Set +” or “Live Set -.”**

When “Live Set +” is selected, the Performances are switched in forward order. When “Live Set -” is selected, the Performances are switched in reverse order.

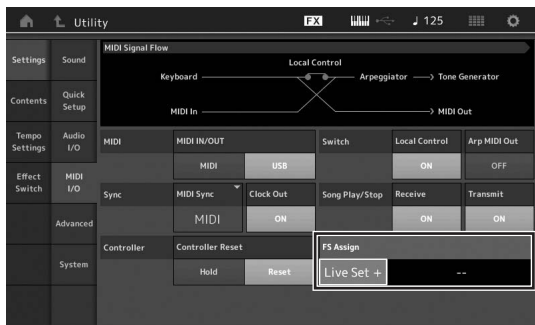

Quick Guide — Editing the Settings

This instrument has various edit displays for Parts, Performances, effects, and Arpeggios. This chapter explains how to create an original Performance by combining multiple Parts.

Performance Editing

“Performance Editing” refers to the process of creating a Performance by changing the parameters that make up the Performance. This can be done in the Performance Edit display.

Basic operations for editing a Performance

- 1 Move the cursor to the Performance name on the Performance Play display, then press the [EDIT] button.
- 2 Touch the [General] tab at the left side of the screen to edit the Performance.

Performance Edit display

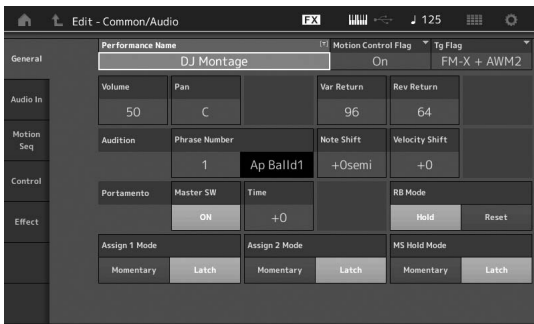

Storing the Performance

After editing, store the Performance to internal memory. Press the [STORE] button to store the Performance.

NOTICE

- The edited Performance will be lost when selecting a different Performance or turning the power off.
- If you overwrite a Performance in the User bank, it will be permanently deleted. When you store the edited Performance, be careful not to overwrite any important User Performances. Important data should always be saved to a USB flash memory device connected to the [USB TO DEVICE] terminal. For detailed instructions on saving, see page 53.

NOTE

You can select any desired Part by using the Number A [1] – [16] buttons during editing of the Performances, and edit the selected Part.

- 1 Press the [STORE] button to call up the Store display.

Storing a new Performance

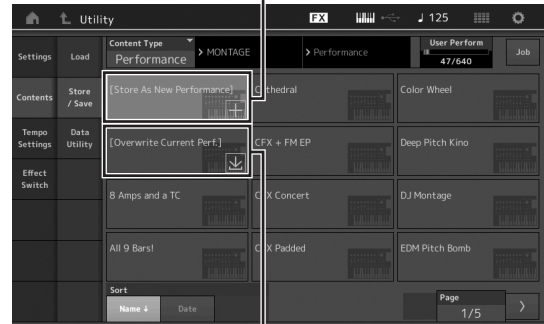

Performance previously stored

- 2 Set the destination for storing the Performance.

To store the newly edited Performance, touch “+” in the [Store As New Performance] section.

NOTE

To overwrite the previously stored Performance, touch [Overwrite Current Perf.] or the Performance to be overwritten.

- 3 The Text Input display appears. Input the name of the stored Performance.

For detailed instructions on inputting characters, see “Naming (character inputting)” in “Basic Operation and Displays” (page 17).

- 4 Select “Done” on the Text Input display to actually execute the Store operation.

NOTE

If you are overwriting the previously stored file, a confirmation display appears after Step 2. Select “YES” to execute the Store operation.

Part Editing

“Part Editing” refers to the process of creating a Part by changing the parameters that make up the Part. This can be done in the Element Common/Key Common/Operator Common Edit display and the Element/Key/Operator Edit display. The actual parameters that are available differ depending on the Part type.

Normal Part (AWM2) Edit

A Normal Part (AWM2) (having pitched musical instrument sounds) can consist of up to eight Elements. An Element is the basic, smallest unit for a Part. There are two types of Normal Part (AWM2) Edit displays: Element Common Edit display, for editing settings common to all eight Elements; and Element Edit display, for editing individual Elements.

An Element is created by applying various parameters (Effect, EG, etc.) to the waveform of the instrument sound. A Normal Part of this instrument (AWM2) consists of up to eight Elements.

Normal Part (FM-X) Edit

A Normal Part (FM-X) (assigned FM-X sounds) can consist of up to eight Operators. There are two types of Normal Part (FM-X) Edit displays: Operator Common Edit display, for editing settings common to all eight Operators; and Operator Edit display, for editing individual Operators.

The abbreviation “FM” of FM-X stands for “frequency modulation,” which is special tone generation system that uses one waveform’s frequency to modulate another waveform, to produce a completely new one. Waveforms are generated by “operators,” of which the MONTAGE has eight. An operator that generates a fundamental waveform is a “carrier,” and an operator that modulates these waveforms is a “modulator.” Each of the eight operators can be used as either a carrier or a modulator. By changing the way operators are combined and controlling the modulation with other parameters such as levels and envelopes, you can create richly textured sounds that change in a highly complex fashion.

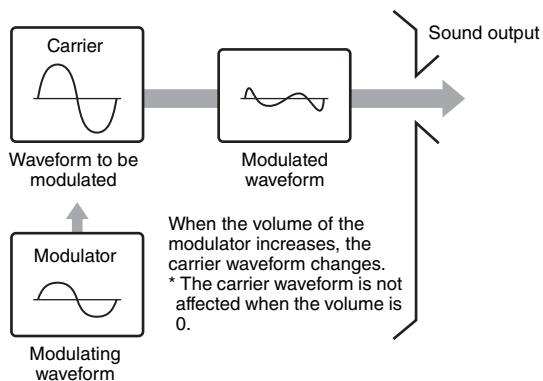

Drum Part Edit

There are two types of Drum Part Edit displays: Key Common Edit display, for editing the settings that apply to all Drum keys; and Key Edit display, for editing individual keys.

Drum Parts are mainly percussion/drum sounds that are assigned to individual Keys. You can create various drum Parts by changing assigned sound types and adjusting the pitch and EQ. Drum Parts of this instrument consist of up to 73 Keys.

Basic operation of Part Edit

- 1 Move the cursor to the Part you want to edit in the Performance Play display, then press the [EDIT] button.
- 2 Make sure that the ELEMENT/OPERATOR [COMMON] button is turned on, and then touch the [Part Settings] tab at the left side of the screen → [General] tab to edit the desired Part.

■ For Normal Parts (AWM2)

For Element Common Editing, press the ELEMENT/OPERATOR [COMMON] button.

For Element Editing, press the corresponding Number button of the element to be edited from among the Number B [1] – [8] buttons.

■ For Drum Parts

For Key Common Editing, press the ELEMENT/OPERATOR [COMMON] button.

For Key Editing, press the Number B [1] – [8] button corresponding to the Drum Part you want to edit (BD, SD, etc.).

You can switch the Keys of each instrument sound (assigned to C1 to C#2) by using the Number B [1] – [8] buttons. For selecting Keys other than the Keys assigned to C1 to C#2, turn on “Keyboard Select” on the display and play the note assigned the Key to be edited.

■ For Normal Parts (FM-X)

For Operator Common Editing, press the ELEMENT/OPERATOR [COMMON] button.

For Operator Editing, press the corresponding Number button of the operator to be edited from among the Number B [1] – [8] buttons.

NOTE

For details about the Part parameters, see the Reference Manual PDF document.

■ Element Common Edit display

Indicates that the Element Common Edit display is active.

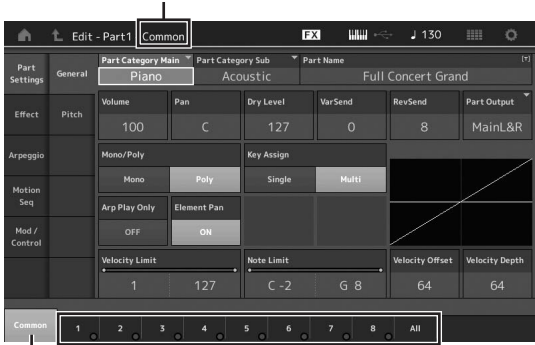

Switches between Element Common Edit and Element Edit.

The structure of the display is the same as for the Key/Operator Common Edit display.

■ Element Edit display

Indicates that the Element Edit display is active.



The structure of the display is the same as for the Key/Operator Edit display.

3 Store the Performance as necessary.

NOTE

You can select any desired Performance by pressing the PART [COMMON] button during editing the Part, and edit the selected Performance.

Part Effect Editing

This instrument features a wide variety of Effects, letting you add Variation and Reverb processing to the selected Part for your keyboard performance. Simply changing the Effect type applied to the preset Part lets you instantly come up with different sounds. The instructions below explain how to set the Effect type and the related parameters applied to the Part, and then store the settings as a User Performance.

- 1 Move the cursor to the Part to be edited on the Performance Play display, and then press the [EDIT] button.
- 2 Press the ELEMENT/OPERATOR [COMMON] button.
- 3 Touch the [Effect] tab in the left of the screen → [Routing] tab.

The Effect display for Element Common Edit appears.

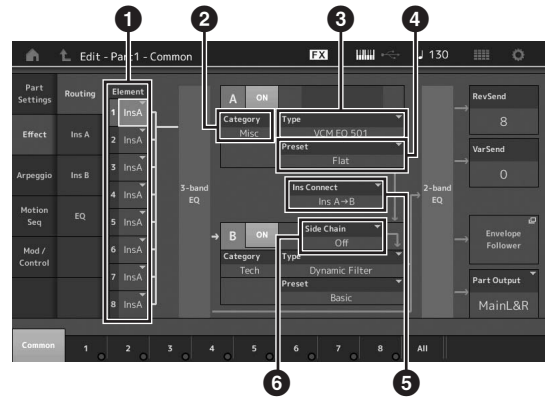

- 1 Output of each Element/Key
 - 2 Category of Insertion Effect A
 - 3 Type of Insertion Effect A
 - 4 Preset of Insertion Effect A
 - 5 Connection method between Insertion Effects A and B
 - 6 Selection of Side Chain/Modulator
- 4 Set the output of each Element/Key (1).
 - 5 Select the parameters (Effect category (2), Effect type (3), and Effect preset (4)) corresponding to Insertion Effect A.
 - 6 Set the connection method between Insertion Effects A and B (5).
 - 7 Set the Side Chain/Modulator of Insertion Effect B (6).

NOTE

The Side Chain/Modulator uses the output from one track to control an effect in a different track. You can specify the Effect type for activating the feature so that input signals for Parts other than the selected Part or the audio input signal can control the specified Effect.

This trigger is called "Side Chain" or "Modulator" depending on the Effect Type.

8 Touch the [Ins A] tab at the left side of the screen.

The display for editing effect parameters selected in Step 4 appears.

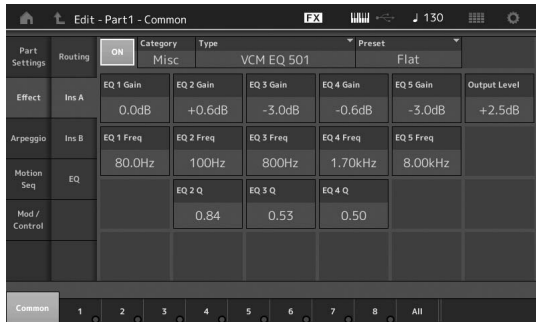

9 Set the parameters as necessary.

Try narrowing in on your desired sound by finely editing the parameters provided for each Effect Type.

Compare function

The Compare function lets you switch between the just-edited sound and its original, unedited condition, allowing you to hear how your edits affect the sound.

Press the [EDIT] button while the Edit display is shown, so that the [EDIT] button flashes. In this status, the sound settings prior to editing will temporarily be reinstated for comparison purposes. Press the [EDIT] button again to return to the original status.

10 Edit Insertion Effect B by using the same operation.

11 Store the Performance as necessary.

How Parts are assigned to a Performance

By default (when shipped from the factory), various types of Performances are provided in the Preset Banks. For some of these Performances, it may not be immediately obvious how to play them or use them, since they are quite complicated. In this section, you'll learn the typical ways in which Performances are created, and thus better understand how to play and use them. This section covers the typical four Part assignments.

Performance Structure

Layer

This method lets you play multiple (two or more) Parts simultaneously by pressing any notes.

For example, you can create a thicker sound by combining two similar Parts—for example, two different Strings Parts, each with a different attack speed.

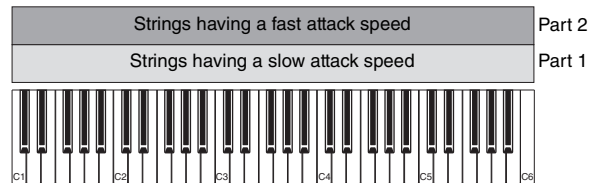

Performance Structure

Split by Note range

This method lets you play different Parts with your left hand and right hand. By assigning a Strings Part to the lower range and assigning a Flute to the higher range separately as illustrated below, you can play Strings accompaniment with your left hand and while playing Flute melody with your right hand.

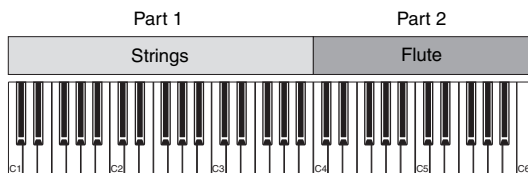

Performance Structure

Split by Velocity range

This method lets you trigger different Parts depending on your playing strength (velocity). In this example below, playing notes at low velocities triggers Strings sounds with a slow attack speed. Playing notes at middle velocities triggers Strings sounds with a fast attack speed. Playing notes at high velocities triggers Orchestra Hits.

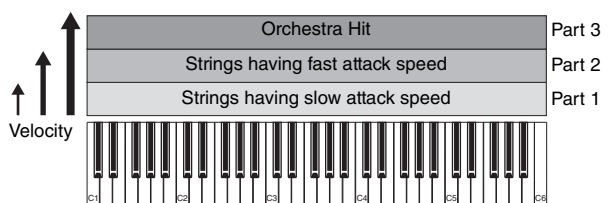

Performance Structure**Using Arpeggios**

With this method, you can play all the parts of a band by yourself. This type of Performance also uses different Arpeggio types assigned to the individual Parts, making it even easier to sound like a full band. In the example below, the Drum pattern (by Arpeggio) will be played back indefinitely even when you release the notes, the Bass line (by Arpeggio) will be played back by your left hand performance, and the Guitar backing (by Arpeggio) or Piano Arpeggio will be played back by your right hand performance. In addition, you can change the Arpeggio Type assignment for each Part by pressing any of the Number C [1] – [8] buttons.

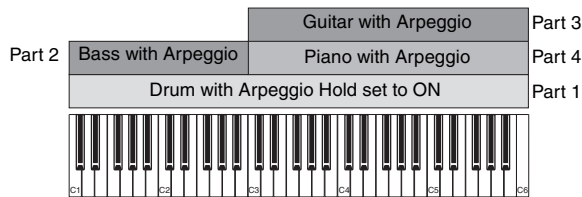

Using or combining the four methods described above gives you the ability to create a rich variety of Performances. By default, many Performances stored in the Preset Banks have been created via the above methods. Try out various Performances and see which method is used for each.

Creating a Performance by combining Parts

After checking out the pre-programmed Performances in the Preset Banks, try creating your own original Performance. In this section, we'll create a Performance by combining two Parts.

Selecting a Performance

For demonstration purposes, we'll assign a piano sound to Part 1.

- 1 Move the cursor to the Part name of the Part 1 on the Performance Play display and press the [CATEGORY SEARCH] button while holding down the [SHIFT] button.**

The Part Category Search display appears.

- 2 Select [Full Concert Grand] from the Performance list.**

- 3 Press the [EXIT] button.**

Playing several Parts together (Layer)

Try combining two Parts by assigning a favorite Part to Part 2.

- 1 Move the cursor to the Part name of the Part 2 on the Performance Play display and select the desired sound by pressing the [CATEGORY SEARCH] button while holding down the [SHIFT] button.**

- 2 Play the keyboard.**

The Part 1 (Piano) and Part 2 (the sound you have selected above) are sounded simultaneously in a layer.

- 3 Press the [EXIT] button.**

Next, let's play different Parts with the left and right hands.

Split

You can play different Parts with the left and right hands by assigning one Part to Part 1, with a note range in the lower section of the keyboard, and a different Part to Part 2, with a note range in the higher section of the keyboard.



- 1 Note Limit Low (the lowest note of the range for the Part)
- 2 Note Limit High (the highest note of the range for the Part)

- 1 Touch the Note Limit High (2) of Part 1 or move the cursor to 2 and press the [ENTER] button.
- 2 Touch the [Keyboard] menu at the left side of the screen to turn it on.
- 3 Set the highest note of Part 1 by pressing the corresponding key.
The note number in the Range section of Part 1 changes.
- 4 Touch the Note Limit Low (1) of Part 2 or move the cursor to 1 and press the [ENTER] button.
- 5 Set the lowest note of Part 2 by pressing the corresponding key.
The note number in the Range section of Part 2 changes.
- 6 Touch the [Keyboard] menu at the left side of the screen to turn it off.
- 7 Play the keyboard.
The notes you play with your left hand sound the Piano Part (Part 1), while the notes you play with your right hand sound the different Part (Part 2) you have selected.

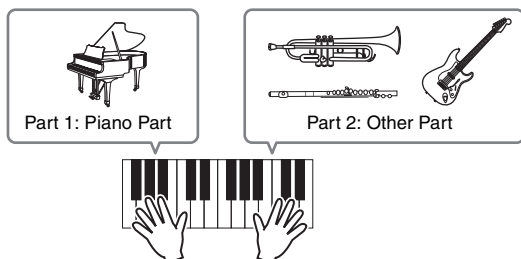

- 8 Turn the [PART CONTROL] button on and adjust the volume settings of Parts 1 and 2 by using Control Sliders 1 and 2.

Changing the note range of the split Part to one octave lower

Change the note range of Part 2 to one octave lower.

- 1 Move the cursor to Part 2 and press the [EDIT] button for Part edit.
- 2 Touch the [Part setting] tab at the left side of the screen → [Pitch] tab.

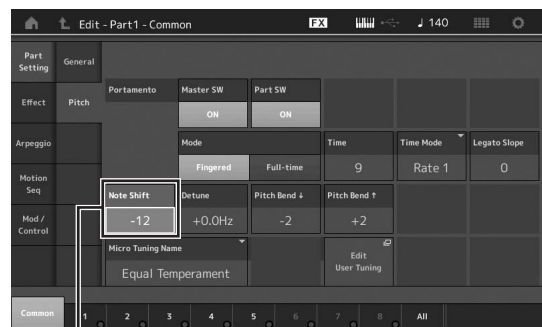

Note Shift

- 3 Select “Note Shift” to adjust the Pitch.
The pitch is shifted in semitone steps. Set “-12” to make the note range one octave lower.
- 4 Play the keyboard.

Changing the Arpeggio settings for each Part

Try changing the Arpeggio settings for each Part. You can assign the rhythm or backing pattern that best matches the desired style of music to the Performance.

- 1 Move the cursor to Part 1 and press the [EDIT] button to call up the Element Common Edit display.
- 2 Touch the [Arpeggio] tab at the left side of the screen → [Common] tab (near the top of the display).
The display for setting common Arpeggio parameters for all Arpeggio type appears.
Note that the Arpeggio Hold parameter is useful as well as the Arpeggio type selection. When this parameter is set to “on,” the Arpeggio playback continues even if the note is released. This parameter should be set to “on” when a Drum sound is assigned to the Part and you wish to have playback of the Arpeggio (rhythm pattern) continue regardless of whether you hold the note or not.



- 3 Touch the [Individual] tab to call up the setting display for each Arpeggio Type.
- 4 Touch the Arpeggio type and select the [Search] menu at the left side of the screen. (Alternately, you can press the [CATEGORY SEARCH] button.)

The Category determines the instrument type and the Sub Category determines the music type.

Setting of Arpeggio type

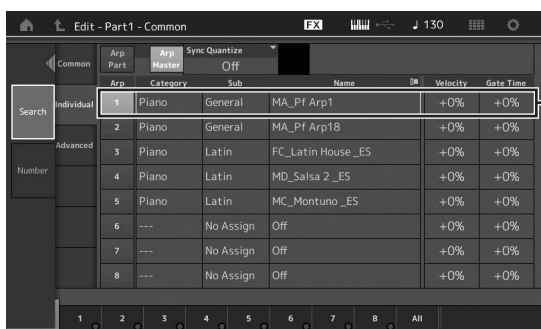

Go on and assign other Arpeggio types in the same way as desired.

- 5 Store the Performance as necessary.

Recording and Playback

You can record MIDI data as Songs on this instrument itself or record your performance (audio data) on a USB flash memory device plugged into the MONTAGE.

Terminology

Song

A Song on this instrument is effectively the same as a song on a MIDI sequencer, and playback automatically stops at the end of the recorded data. The MONTAGE can store up to 64 Songs.

Track

This is a memory location on the sequencer where your musical performances (made up of MIDI events) are stored. The MONTAGE provides 16 tracks, which correspond to the 16 Mixing Parts.

Realtime Recording

The instrument records the performance data as it is played along with a metronome. Realtime Recording features three available methods: Replace, Overdub and Punch In/Out.

- Replace lets you overwrite an already recorded Track with new data, erasing the previously recorded data.
- Overdub lets you add more data to a Track that already contains data—in other words, recording new notes on top of the previous ones.
- Punch In/Out lets you re-record selectively over a specific area of the Track.

MIDI Recording

This instrument features a Performance Recorder (built-in multi Track sequencer) for recording your keyboard performance as MIDI data. This function allows you to instantly store your phrase which comes to your mind. You can create full, complex multi-instrument arrangements and complete Songs, using DAW.

Recording to a track

In this section, you'll learn how to record your keyboard performance, by recording a part to Track 1. However, you'll first need to set up the MONTAGE for recording.

1 Touch the [Play/Rec] tab in the left of the Performance Play display.

The recording display appears.

2 Touch the [MIDI] tab in the left of the screen.

3 Press the [●] (Record) button.

The Record Setup display appears.

NOTE

Alternately, you can simply press the [●] (Record) button in the Performance display, to perform Steps 1 – 3 at once.

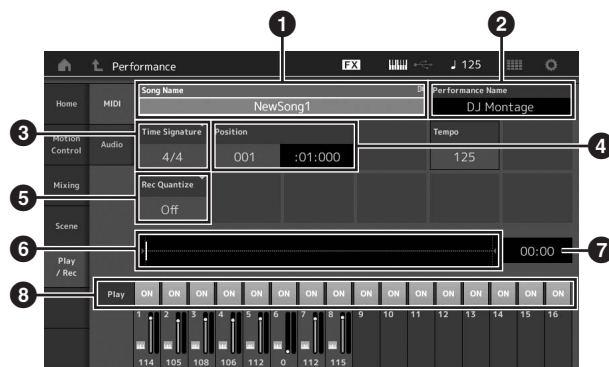

- 1 Song name
- 2 Currently selected Performance name
- 3 Time Signature (Meter)
- 4 Position (starting position of Recording/Playback)
- 5 Quantize
- 6 Position corresponding to the entire sequence
- 7 Recorded time of the entire sequence
- 8 Playback on/off for each track

4 Set the following parameters on the Record Setup display.

- 4-1 Move the cursor to Time Signature (Meter) (3), and then set the value. For this example, set this to "4/4."
- 4-2 Set Quantize to "240 (8th note)" in Record Quantize (5). This convenient feature lets you automatically quantize (or "clean up" the timing of) the notes in real time, as you record. Quantize aligns the timing of note events to the nearest beat. Normally, the smallest note value in the notation (if you're playing from sheet music) should be set.

5 After completing recording setup, press the [▶] (Play) button to start recording.

Press the [▶] (Play) button, then actually start recording after the count-in.

6 When you've finished playing, press the [■] (Stop) button to stop recording.

If you've played any wrong notes, press the [■] (Stop) button, then try recording again.

Recording with the click

Follow the steps below to use the click during MIDI recording.

- 1 Press the [UTILITY] button and touch [Tempo Settings] on the screen to call up the Tempo setting display. Set the Click “Mode” to “Rec.”

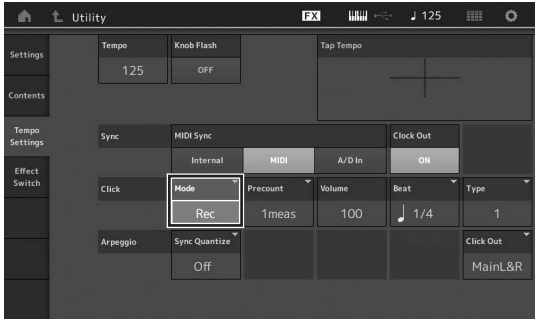

NOTE

When “Rec/Play” is set, the click sounds during MIDI recording and playback. When “Always” is set, the click will always sound.

Re-recording a specific part of a Song (Punch In/Out)

Use the Punch In/Out recording method to record over only a specific portion of the Track. If you set the start point (Punch In) and end point (Punch Out), and then start recording from the top of the Song, the actual recording will be done only between the Punch In and Punch Out points. In the eight-measure example below, only the third through the fifth measures are re-recorded.

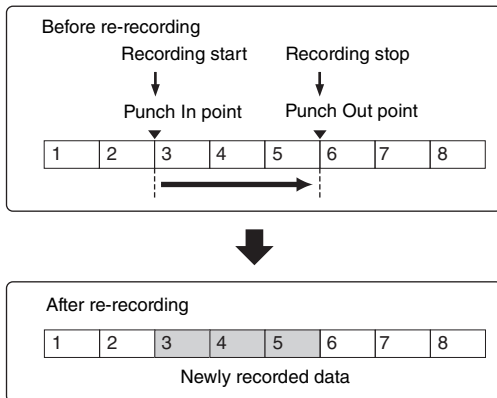

NOTE

Note that the Punch In/Out method always replaces (destroys) the original data over the specified area.

To execute Punch In/Punch Out recording in the above condition, set the following parameters beforehand on the Record Setup display.

- 1 “Record Type”: “punch”
- 2 Punch In: 003:01
Playback of the recording Track is turned off from this point, and your keyboard performance will be recorded to the Track.

- 3 Punch Out: 006:01
Recording ends at this point and normal playback of the recording Track starts.

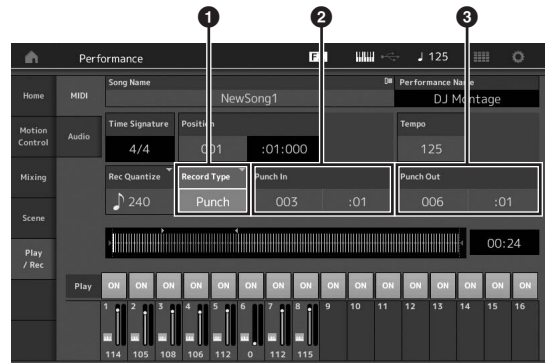

Cancelling your most recent recording (Undo/Redo)

The Undo Job cancels the changes you made in your most recent recording session and restores the data to its previous state. Redo is available only after using Undo, and lets you restore the changes you made before undoing them.

- 1 Undo (This display is not available if nothing has been recorded.)
When [Undo] is touched, the display prompts you for confirmation. Selecting Undo cancels the previous recording.



- 2 Redo (This display is not available if Undo has not been operated.)
When [Redo] is touched, the display prompts you for confirmation. Selecting Redo restores the change you made.



Playing a Song

In this section, you'll learn how to use convenient mute/solo functions while playing back a recorded song.

Song playback

1 Press the [▶] (Play) button to start the Song.

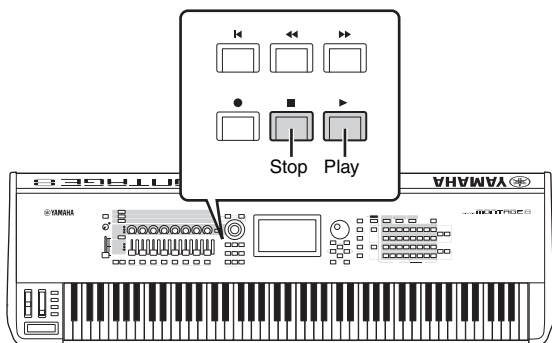

NOTE

To adjust the volume level of the Songs, use the [MASTER VOLUME] slider.

2 Press the [■] (Stop) button to stop the Song.

Adjusting the volume of each Part

You can adjust the volume for each of eight Parts, using the panel sliders.

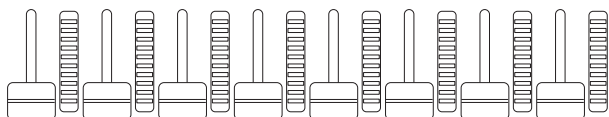

When one of Tracks 1 – 8 is currently selected, the eight sliders are used to adjust the volume for Parts 1 – 8. When one of Tracks 9 – 16 is selected, the sliders are used to adjust the volume for Parts 9 – 16. The track can be selected by turning the [PART CONTROL] button on and pressing the desired Number button among the Number A [9] – [16] buttons.

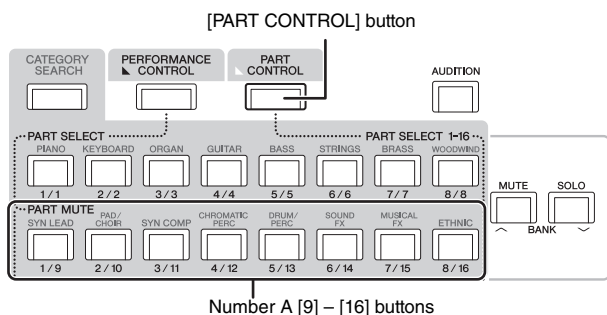

In addition to sliders, the Knobs 1 – 8 can be used to affect the Part setting of the Song playback in real time. For details, refer to the Reference Manual PDF document.

Recording your performance as audio

Your performances on the MONTAGE can be recorded as WAV format (44.1-kHz, 24-bit, stereo) audio files to a USB flash memory device. The recording level is fixed, and it is possible to record continuously for up to 74 minutes (assuming that the USB storage device has sufficient free memory).

NOTICE

The MONTAGE or the selected storage device should never be turned off during recording, playback, or while the recorded audio file is being saved. Turning off either device at that time may make it impossible to subsequently access the storage device.

1 Connect a USB flash memory device to the [USB TO DEVICE] terminal of the MONTAGE.

2 Touch the [Play/Rec] tab in the left of the Performance Play display.

The recording display appears.

3 Touch the [Audio] tab in the left of the screen.

4 Press the [●] (Record) button to setup the audio recording.

The Record Setup display appears.

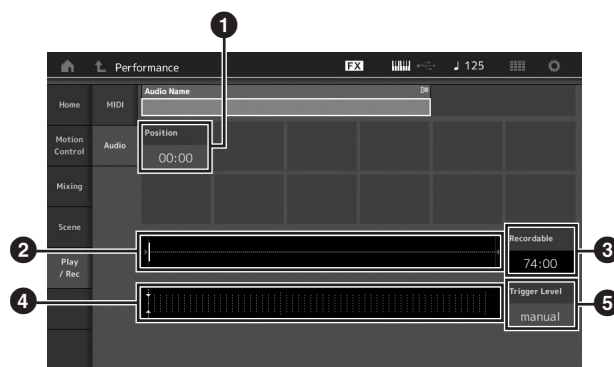

- 1 Play position
- 2 Current play position in the entire audio data
- 3 Available recording time
- 4 Level meter
- 5 Trigger level

5 Set the required trigger level (5).

If you set the trigger level to "manual," recording will begin whenever you press the [▶] (Play) button. Alternatively, if you set a value between 1 and 127, recording will begin automatically whenever the playback volume exceeds that level. The level set here will be indicated by blue triangles in the level meter (4). For best results, set this parameter as low as possible to capture the entire signal, but not so low as to record unwanted noise.

6 Press the [▶] (Play) button.

If you have set the trigger level to “manual,” recording will begin immediately right after you press the [▶] (Play) button. While the recording, the [●] (Record) button will light red and the [▶] (Play) button will light green. If you have set a value between 1 and 127 as the trigger level, the recording will begin automatically whenever the playback volume exceeds that level.

7 Play the keyboard.

If you set the trigger level to a value between 1 and 127, recording will begin automatically whenever the playback volume exceeds that level.

8 When you have finished playing, press the [■] (Stop) button.

The recorded audio file will be saved on the selected device.

Playing an audio file

As described below, the MONTAGE can play audio files (.wav) from a USB flash memory device, regardless of whether they have been created by the instrument itself or come from another source.

- 1 Connect a USB flash memory device to the [USB TO DEVICE] terminal of the MONTAGE.
- 2 Touch the [Play/Rec] tab → [Audio] tab at the left side of the Performance display.
- 3 Touch “Audio Name” and then select [Load] menu at the left side of the screen.
- 4 Select the source USB flash memory device and folder.
- 5 Select the desired file (.wav) on the USB flash memory device to execute the Load operation.

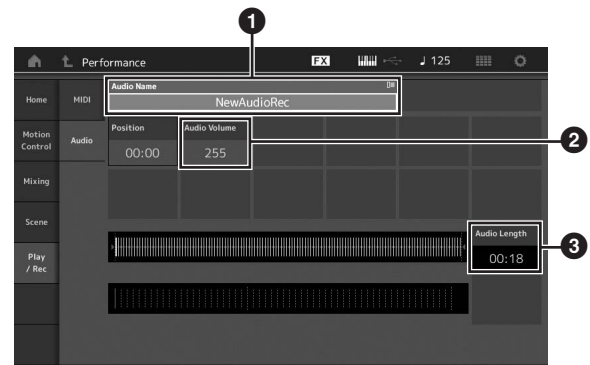

- 1 Audio name
- 2 Audio volume
- 3 Audio length

6 Press the [▶] (Play) button.

The audio file will begin playing.

7 Move the cursor to “Audio Volume” (2), and then adjust the playback volume by using the data dial.

8 Press the [■] (Stop) button to stop playback.

NOTE

Keep in mind that you can also play a selected Performance on the keyboard during audio playback.

Using as a Master Keyboard

The Master Keyboard function lets you assign up to eight separate Zones in each Performance for use as a master keyboard controller.

You can call up the settings for controlling an external MIDI device instantly anytime you need by combining with the Live Sets. Accordingly, you can change and control the connected external MIDI tone generator in sequence while performing live.

Making settings for use as a master keyboard—Zone

When you use the MONTAGE as a master keyboard, you can divide the keyboard into a maximum of eight independent areas (called “Zones”). Different MIDI channels and different functions of the Knobs and Control Sliders can be assigned to each Zone. This makes it possible to control several Parts of the internal multi-timbral tone generator simultaneously by a single keyboard, or control Performances of an external MIDI instrument over several different channels in addition to the internal Performances of this synthesizer itself—letting you use the MONTAGE to effectively do the work of several keyboards. You can set the parameters related to the eight Zones and store the settings.

First, set the MONTAGE as a master keyboard by activating the Zone settings.

- 1 Press the [UTILITY] button to call up the Utility display.
- 2 Touch the [Settings] tab → [Advanced] tab at the left side of the screen.
- 3 Touch [Zone Master] to turn it on.

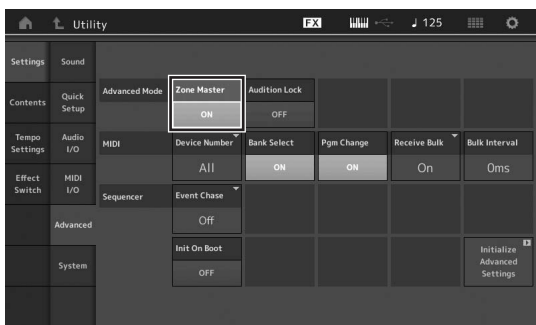

- 4 Press the [EXIT] button. This stores the setting and returns to the previous display.

Next, make settings according to the Master Keyboard (Zone) for each Performance.

- 1 Press the [PERFORMANCE] button to call up the Performance Play display.
- 2 Move the cursor to the desired Part of the currently selected Performance and press the [EDIT] button to edit the Part.
- 3 Touch the [Part Settings] tab → [Zone Settings] tab at the left side of the screen.
- 4 Touch [Zone] to turn it on.
- 5 Set the Zone related parameters such as MIDI transmit channel and Note Limit.

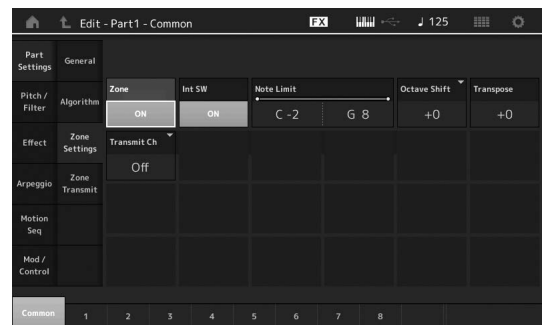

- 6 Touch the [Zone Transmit] tab to set the transmit switches as desired.

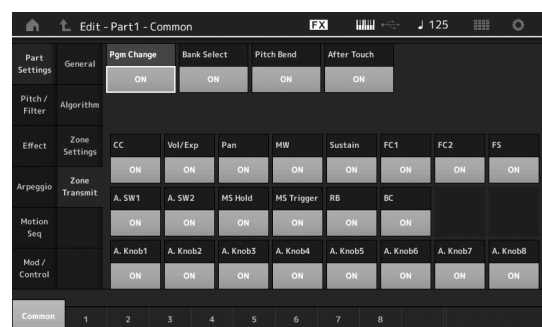

After completing these settings, press the [STORE] button to store the Performances.

For details about Zone settings, see the Reference Manual PDF document.

Connecting a Microphone or Audio Equipment

Playing the keyboard along with the sound input from the A/D INPUT [L/MONO]/[R] jacks

You can have the A/D input sound—such as your voice through a microphone, a CD player, or a synthesizer—assigned as an Audio Input Part. Various parameters such as volume, pan, and effects can be set to this Part and the sound is output together with the sound of your keyboard performance.

- 1 Make sure to turn off the power of this instrument and set the A/D INPUT [GAIN] knob to the minimum.
- 2 Connect the audio equipment or the microphone to the A/D INPUT [L/MONO]/[R] jack on the rear panel.

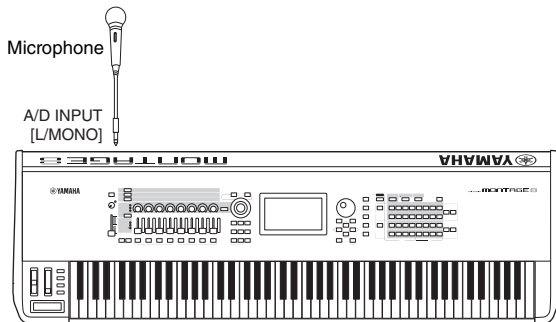
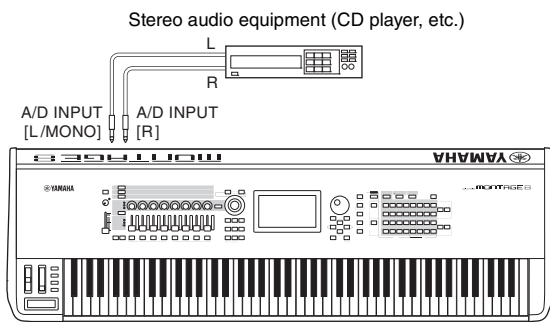

NOTE

A standard dynamic microphone is recommended. (This instrument does not support phantom-powered condenser microphones.)

- 3 Turn on the connected audio equipment, then turn on the MONTAGE.
- 4 Press the [UTILITY] button to call up the Utility display, and touch the [Settings] tab → [Audio I/O] tab at the left side of the screen.

- 5 Set the “Mic/Line” parameter according to the particular equipment connected to the A/D INPUT [L/MONO]/[R] jacks.

When connecting equipment of low output level such as a microphone, set this parameter to “Mic.” When connecting equipment of high output level (such as a synthesizer keyboard, CD player, portable music player), set this parameter to “Line.”

- 6 Press the A/D INPUT [ON/OFF] button so that its lamp lights.

This setting enables audio signals to be input from the connected audio device.

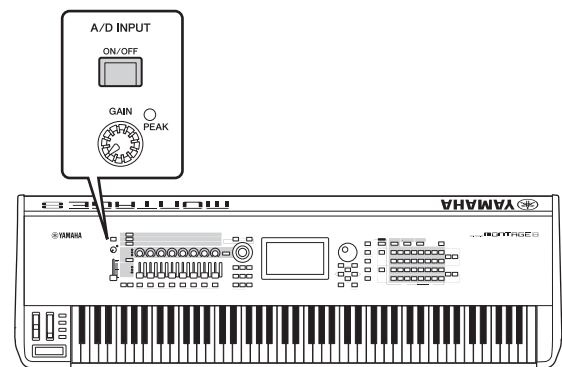

- 7 Adjust the input level by using the [GAIN] knob.

NOTE

Adjust the input level with the [GAIN] knob so that the PEAK LED lights briefly only at the loudest input sounds.

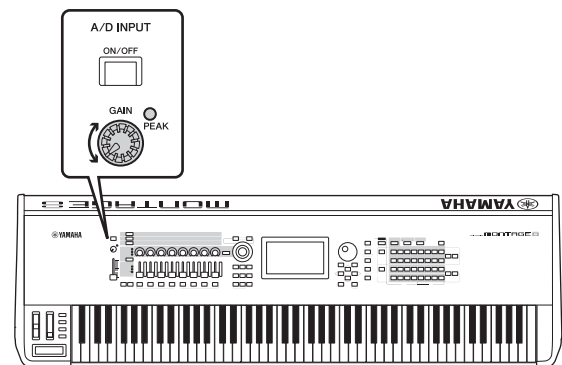

- 8 Press the [PERFORMANCE] button, and then select the desired Performance.

Play the keyboard while you sing into the microphone or play back the audio equipment.

Making Global System Settings

You can set various parameters in the Utility display. In particular, you can set the parameters that apply to the entire system of this instrument by touching the [Settings] tab. The changes you make in the Utility display are activated once you press the [EXIT] button to return to the original display. This section describes some useful functions related to the entire system settings.

Setting automatic power-on tasks

You can determine which display is automatically called up when power is turned on: the Live Set display or the Performance Play display.

- 1 Press the [UTILITY] button to call up the Utility display, then touch [Settings] tab → [System] tab.
- 2 In [Power on Mode], select “Live Set” (Live Set display) or “Perform” (Performance Play display) as the start-up display.

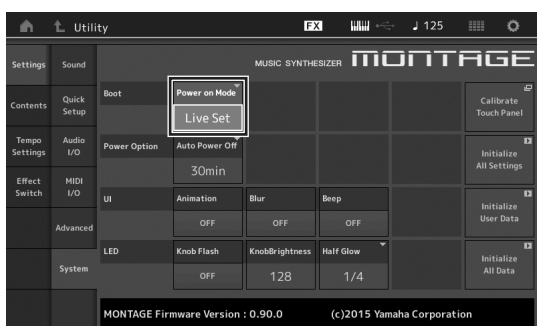

- 3 Press the [EXIT] button.
This stores the setting and returns to the previous display.

Setting button lamp behavior

You can control the dimming of the button lamps.

- 1 Press the [UTILITY] button to call up the Utility display, then touch [Settings] tab → [System] tab.
- 2 Set “Half Glow” to “Off,” “1/4,” or “1/2.”
When “Off” is selected, the dimming function is turned off.
When “1/4” is selected, the brightness of the button in the dimly lit condition is reduced to 25% of the fully lit condition. This lighting level is suitable for dark surroundings, such as a stage.
When “1/2” is selected, the brightness of the button in the dimly lit condition is reduced to 50% of the fully lit condition. This lighting level is useful in bright surroundings (such as outdoors) when it is hard to distinguish whether the button is dimly lit or off.
- 3 Press the [EXIT] button.
This stores the setting and returns to the previous display.

Turning various functions on/off

You can set various functions by touching the [System] tab on the Utility display.

Turning animation on/off

You can turn the animation of screen transition on/off as follows.

- 1 Press the [UTILITY] button to call up the Utility display, then touch [Settings] tab → [System] tab.
- 2 Select “ON” or “OFF” in “Animation” to turn the animation on or off.



- 3 Press the [EXIT] button.
This stores the setting and returns to the previous display.

Turning display blur effect on/off

When any display is selected, the display previously selected is blurred. You can turn the function on/off as follows.

- 1 Press the [UTILITY] button to call up the Utility display, then touch [Settings] tab → [System] tab.
- 2 Set “Blur” to “ON” or “OFF” to turn the blur effect on or off.
- 3 Press the [EXIT] button.
This stores the setting and returns to the previous display.

Turning the beep sound on/off

You can turn the beep sound (that confirms operations, menu/parameter selection, etc.) on/off as follows.

- 1 Press the [UTILITY] button to call up the Utility display, then touch [Settings] tab → [System] tab.
- 2 Set “Beep” to “ON” or “OFF” to turn the beep on or off.
- 3 Press the [EXIT] button.
This stores the setting and returns to the previous display.

Turning the flashing of the Super Knob on/off

In the default setting, the Super Knob flashes at the current beat. You can turn this flashing on/off as follows. When the function is turned off, the Super Knob remains lit continuously.

- 1 Press the [UTILITY] button to call up the Utility display, then touch [Settings] tab → [System] tab.
- 2 Select “ON” or “OFF” in “Knob Flash” to turn the flashing on or off.

Touch panel calibration

Calibration of the touch panel may be necessary if the touch panel seems occasionally unresponsive or the response is erratic.

- 1 Hold down the [UTILITY] button and press the PART [COMMON] button.
The Utility display appears, with the [Calibrate Touch Panel] selected.
- 2 Press the [ENTER] button.
- 3 A white square appears. Touch the square to calibrate the touch panel, and continue with subsequent white squares until the operation is finished.

NOTE

Alternately, you can touch [UTILITY] → [Settings] → [System] to call up the System setting display and touch [Calibrate Touch Panel].

Changing the Master Tuning

You can adjust the tuning of the MONTAGE. This is useful when playing in an ensemble to match the pitch of other instruments which cannot be easily tuned (such as a piano).

- 1 Press the [UTILITY] button to call up the Utility display, then touch [Settings] tab → [Sound] tab.



- 2 Select “Tune” and change the parameter by using the Data dial.

In this example, we'll change the value from “440 Hz” to “442 Hz.” Since the Tune parameter is actually adjusted in cents (1 cent = 1/100th of a semitone), the corresponding value in Hertz is shown at right. Turn the data dial to change the value to “+8.0.” Use a tuner for the more accurate tuning as necessary.

- 3 Press the [EXIT] button.

This stores the setting and returns to the previous display.

Changing the Velocity Curve

These five curves determine how the actual velocity will be generated and transmitted according to the velocity (strength) with which you play notes on the keyboard. The graph shown in the display indicates the velocity response curve. (The horizontal line represents the received velocity values (strength of your playing), while the vertical line represents the actual velocity values transmitted to the internal/external tone generators.)

- 1 Press the [UTILITY] button to call up the Utility display, then touch [Settings] tab → [Sound] tab.

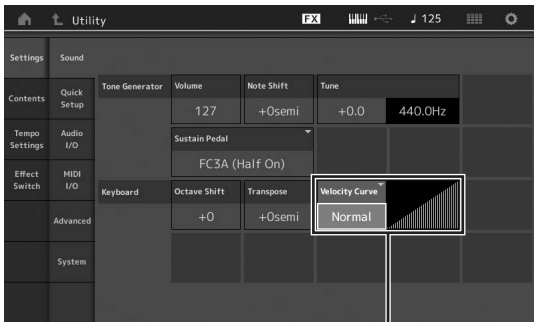

Velocity Curve

- 2 Select “Velocity Curve” and change the curve setting as desired, from the pop-up menu at the left of the display.

| | |
|---------------|---|
| Normal | This linear “curve” produces one-to-one correspondence between the strength of your keyboard playing (velocity) and the actual sound change. |
| Soft | This curve provides increased response, especially for lower velocities. |
| Hard | This curve provides increased response, especially for higher velocities. |
| Wide | This curve accentuates your playing strength by producing lower velocities in response to softer playing and louder velocities in response to harder playing. As such, you can use this setting to expand your dynamic range. |
| Fixed | This setting produces the same amount of sound change (set in Fixed Velocity below), no matter what your playing strength. |

When the parameter of the Velocity Curve is set to “Fixed”

The velocity of the note you play is fixed at the value set here.

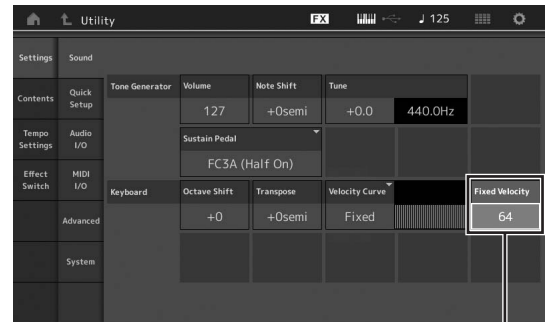

Setting the Fixed Velocity value

- 3 Press the [EXIT] button.

This stores the setting and returns to the previous display.

Setting Local Control on/off

Local Control is usually set to on; however, in some cases (when using with a computer and sequencer program), you may want to turn it off so that the keyboard does not play the internal Parts, but the appropriate MIDI information is still transmitted via the MIDI OUT terminal when notes are played on the keyboard. Also, the input MIDI information is appropriately processed in this instrument.

- 1 Press the [UTILITY] button to call up the Utility display and touch the [Settings] tab at the left side of the screen → [MIDI I/O] tab.

- 2 Set “Local Control” to either “ON” or “OFF.”

- 3 Press the [EXIT] button.

This stores the setting and returns to the previous display.

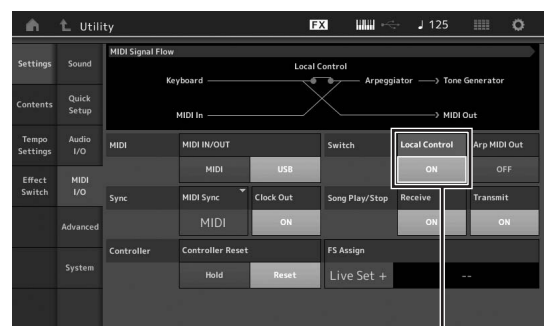

Local Control

Connecting External MIDI Instruments

With a standard MIDI cable (available separately), you can connect an external MIDI instrument, and control it from the MONTAGE. Likewise, you can use an external MIDI device (such as a keyboard or sequencer) to control the sounds on the MONTAGE. Below are several different MIDI connection examples; use the one most similar to your intended setup.

NOTE

Either of the built-in interfaces, the MIDI terminals, or the [USB TO HOST] terminal, can be used for MIDI data transmission/reception; however, they cannot be used at the same time. Select which terminal is to be used for MIDI data transfer by pressing the [UTILITY] button → [Settings] tab → [MIDI I/O] tab. As you work through the explanations in this chapter, set "MIDI IN/OUT" to "MIDI" since MIDI is used as the example connection here.

Controlling the MONTAGE from an external MIDI keyboard or synthesizer

Use an external keyboard or synthesizer to remotely select and play the Performances of the MONTAGE.

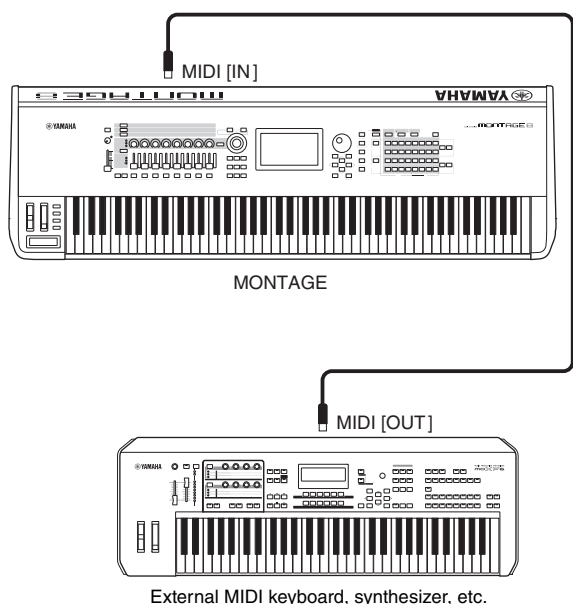

MIDI Transmit and Receive Channels

Make sure to match the MIDI Transmit Channel of the external MIDI instrument with the MIDI Receive Channel of the MONTAGE. For details on setting the MIDI Transmit Channel of the external MIDI instrument, refer to the owner's manual of that instrument. Each MIDI Receive Channel number of the MONTAGE corresponds to each Part number such as Channel 1 for Part 1, Channel 2 for Part 2, and so on.

Controlling an external MIDI keyboard or synthesizer from the MONTAGE

This connection lets you sound an external MIDI tone generator (synthesizer, tone generator module, etc.) by playing the MONTAGE or playing back Songs from the

MONTAGE. Use this connection when you wish to sound the other instrument as well as the MONTAGE.

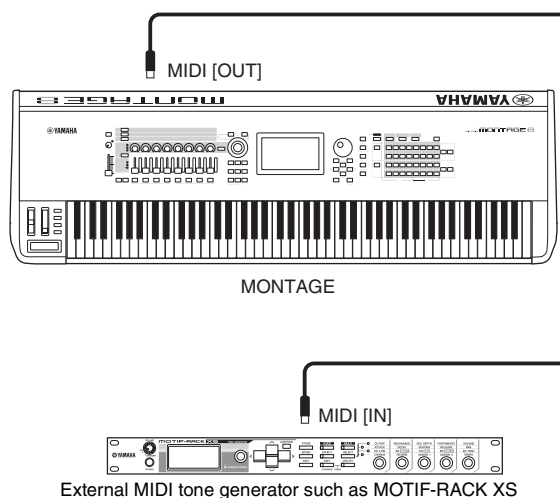

Splitting the sound between the MONTAGE and an external tone generator by MIDI channel

Using the connection example shown above, you can play both instruments and have them separately sound different parts—for example, having your keyboard performance sound the external instrument while the Song plays the sounds of the MONTAGE. To use this feature, you must set the MONTAGE's transmit channel and the external tone generator's receive channel to the same channel number. Each MIDI transmit channel number of the MONTAGE corresponds to each Part number such as Channel 1 for Part 1 or Channel 2 for Part 2. However, you can choose the desired transmit channel by the following steps. Press [UTILITY] → [Settings] → [Advanced], then set "Zone Master" to "ON." For editing the Part, touch [Part Settings] → [Zone Settings] to call up the Zone setting display. Check the MIDI transmit channel in "Zone Transmit," then change this parameter, if necessary. When you wish to sound only the external tone generator, set the master volume of the MONTAGE down or set "Local Control" to "off" with the following operation: [UTILITY] → [Settings] → [MIDI I/O] to call up the MIDI setting display, then set "Local Control" to "off." For information on how to set the MIDI Receive Channel of the external MIDI instrument, refer to the owner's manual of that particular MIDI instrument.

Using a Connected Computer

By connecting the MONTAGE to your computer, you can use a DAW or sequence software on the computer to create your own original songs.

NOTE

The acronym DAW (digital audio workstation) refers to music software for recording, editing and mixing audio and MIDI data. The main DAW applications are Cubase, Logic, Ableton Live, and ProTools.

Connecting to a computer

A USB cable and the Yamaha Steinberg USB Driver are necessary to connect the MONTAGE to the computer. Follow the instructions below. Note that both audio data and MIDI data can be transmitted through a USB cable.

1 Download the latest Yamaha Steinberg USB Driver from our website.

After clicking the Download button, extract the compressed file.

<http://download.yamaha.com/>

NOTE

- Information on system requirements is also available at the above website.
- The Yamaha Steinberg USB Driver may be revised and updated without prior notice. Make sure to check and download the latest version from the above site.

2 Install the Yamaha Steinberg USB Driver to the computer.

For instructions on installing, refer to the online Installation Guide included in the downloaded file package. When connecting this instrument to a computer, connect the USB cable to the [USB TO HOST] terminal of this instrument and the USB terminal of the computer as shown below.

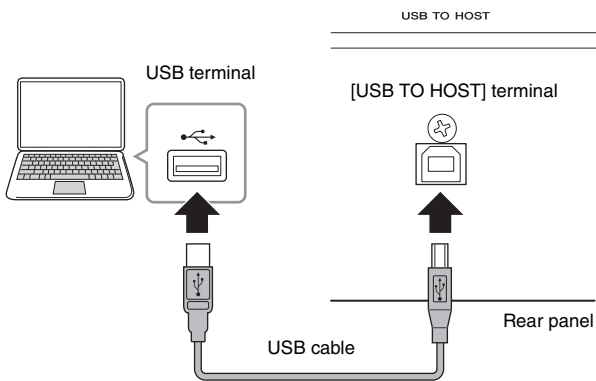

3 Press the [UTILITY] button to call up the Utility display.

4 Touch [Settings] tab → [MIDI I/O] tab at the left side of the display.

5 Set “MIDI IN/OUT” to “USB.”

Make sure that the [USB TO HOST] terminal of this instrument is enabled.

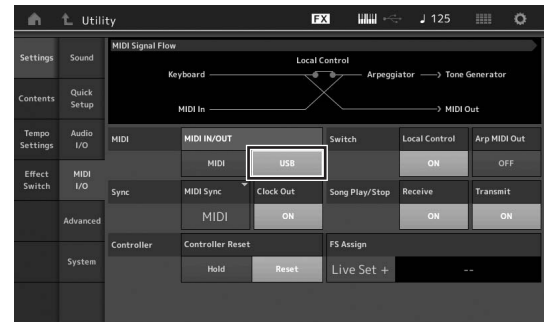

6 Set the input and output settings for audio data as desired to suit your personal preferences.

The change can be made from [UTILITY] → [Settings] → [Audio I/O].

Using the Quick Setup function to change parameters related to audio and MIDI data, lets you instantly reconfigure the MONTAGE for different computer/sequencer related applications by simply calling up specially programmed presets.

To do this, touch [Settings] tab → [Quick Setup] tab at the left side of the display to call up the Quick Setup display.

Touch [Store Current Settings] to store the desired setting in any of the 1 to 3 Quick Setups.

NOTE

For details on the parameters available for setting with the Quick Setup function, see the Reference Manual PDF document.

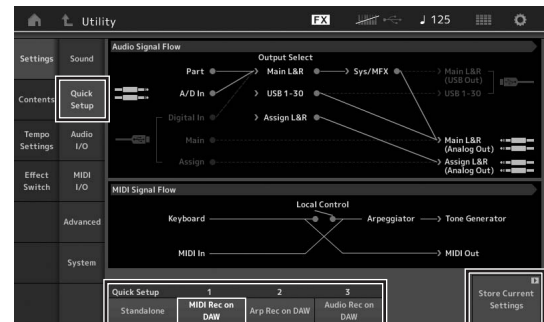

Quick Setups 1 to 3

Precautions when using the [USB TO HOST] terminal

When connecting the computer to the [USB TO HOST] terminal, make sure to observe the following points. Failing to do so risks freezing the computer and corrupting or losing the data.

If the computer or the instrument freezes, restart the application software or the computer OS, or turn the power to the instrument off then on again.

NOTICE

- Use an AB type USB cable.
- Before connecting the computer to the [USB TO HOST] terminal, exit from any power-saving mode of the computer (such as suspend, sleep, standby).
- Before turning on the power to the instrument, connect the computer to the [USB TO HOST] terminal.
- Execute the following before turning the power to the instrument on/off or plugging/unplugging the USB cable to/from the [USB TO HOST] terminal.
 - Quit any open application software on the computer.
 - Make sure that data is not being transmitted from the instrument. (Data is transmitted only by playing notes on the keyboard or playing back a song.)
- While the computer is connected to the instrument, you should wait for six seconds or more between these operations: (1) when turning the power of the instrument off then on again, or (2) when alternately connecting/disconnecting the USB cable.

MIDI channels and MIDI ports

MIDI data is assigned to one of sixteen channels, and this synthesizer is capable of simultaneously playing sixteen separate Parts, via the sixteen MIDI channels. However, the sixteen-channel limit can be overcome by using separate MIDI "ports," each supporting sixteen channels. While a single MIDI cable is equipped to handle data over up to sixteen channels simultaneously, a USB connection is capable of handling far more—thanks to the use of MIDI ports. Each MIDI port can handle sixteen channels, and the USB connection allows up to eight ports, letting you use up to 128 channels (8 ports x 16 channels) on your computer.

When connecting this instrument to a computer using a USB cable, the MIDI ports are defined as follows:

Port 1

The tone generator block in this instrument can recognize and use only this port. When playing the MONTAGE as a tone generator from the external MIDI instrument or computer, you should set the MIDI Port to 1 on the connected MIDI device or computer.

Port 3

This port is used as the MIDI Thru Port. The MIDI data received over Port 3 via the [USB TO HOST] terminal will be re-transmitted to an external MIDI device via the MIDI [OUT] terminal.

The MIDI data received over Port 3 via the MIDI [IN] terminal will be re-transmitted to an external device (computer, etc.) via the [USB TO HOST] terminal. When using a USB connection, make sure to match the MIDI transmit port and the MIDI receive port as well as the MIDI transmit channel and the MIDI receive channel. Make sure to set the MIDI port of the external device connected to this instrument according to the above information.

Audio channels

The audio signals of the MONTAGE can be output to the [USB TO HOST] terminal and the OUTPUT [L/MONO]/[R] jacks.

When connecting to a computer, use the [USB TO HOST] terminal. In this case, up to 32 audio channels (16 stereo channels) are available when the sampling frequency is 44.1 kHz, and up to eight audio channels (four stereo channels) are available when the sampling frequency is between 44.1 kHz and 192kHz. The output-to-channel assignments are made as follows: [EDIT] → [Part Settings] → "Part Output" in the [General] display.

The audio signals of the MONTAGE can be input from the [USB TO HOST] terminal and the A/D INPUT [L/MONO]/[R] jacks.

Up to six channels (three stereo channels) of audio can be input to the [USB TO HOST] terminal. Set the output level in the Mixing display or the Performance edit display. The signals are output to the OUTPUT [L/MONO]/[R] jack (two channels.) Also, up to two audio channels (one stereo channel) can be input to the A/D INPUT [L/MONO]/[R] jacks. The signal is sent to the A/D input part of the MONTAGE. For more details, see the Reference Manual PDF document.

Creating a Song with a computer

By using the MONTAGE with DAW software on a computer connected to the MONTAGE, you can take advantage of the following functions and applications.

- MIDI recording and audio recording of your MONTAGE performance to the DAW software.
- Playing back a song from the DAW software by using the MONTAGE tone generator.

This section contains an overview on how to use DAW software on the computer with the MONTAGE after connecting (page 49).

Recording your performance on the MONTAGE to computer as MIDI data (no Arpeggio playback recorded)

In this method, you record your performance on the MONTAGE to DAW simply as MIDI data. Keep in mind that Arpeggio playback cannot be recorded.

Setting up the MONTAGE

- 1 Press the [UTILITY] button to call up the Utility display.
- 2 Touch [Settings] tab → [Quick Setup] tab at the left side of the display to call up the Quick Setup display.
- 3 Select “1 (MIDI Rec on DAW)” of “Quick Setup.”

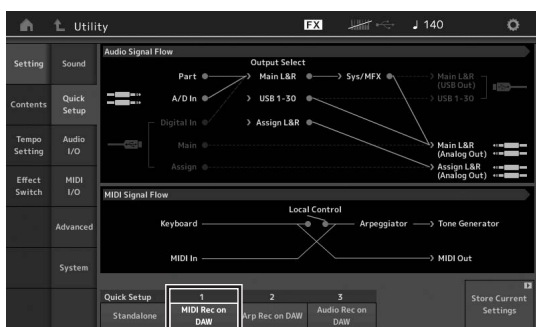

- 4 Press the [EXIT] button to select the Performance you want to record.

Setting up the DAW software

- 1 Set MIDI Thru to “on” on the DAW software.

By setting MIDI Thru to “on,” the MIDI data generated by playing the keyboard and transmitted to the computer will be returned back to the MONTAGE. As shown in the example below, the MIDI data transmitted from the MONTAGE then recorded to the computer via MIDI channel 1 will be returned back from the computer to the MONTAGE via MIDI channel 3 according to the setting of the recording Track. As a result, the tone generator of the

MONTAGE will sound the MIDI data generated by playing the keyboard as MIDI data from channel 3.

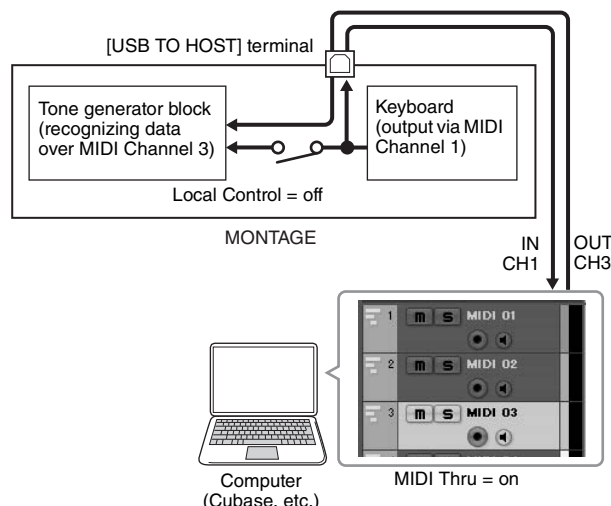

- 2 Record your MONTAGE performance on the DAW software.

Recording your performance on the MONTAGE to computer as MIDI data (with Arpeggio playback recorded)

In this method you can record Arpeggio playback on the MONTAGE to DAW as MIDI data.

Setting up the MONTAGE

- 1 Press the [UTILITY] button to call up the Utility display.
- 2 Touch [Settings] tab → [Quick Setup] tab at the left side of the display to call up the Quick Setup display.
- 3 Select “2 (Arp Rec on DAW)” of “Quick Setup.”

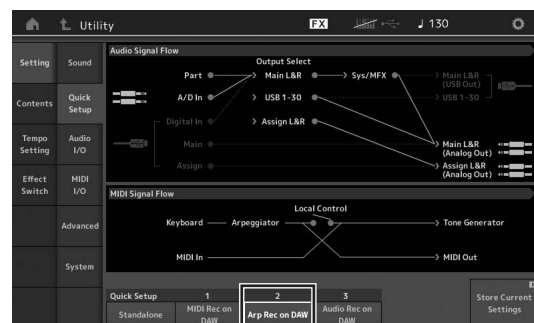

- 4 Press the [EXIT] button to select the Performance you want to record.

Setting up the DAW software

Follow the same operations in “Recording your performance on the MONTAGE to computer as MIDI data (no Arpeggio playback recorded).”

Song playback from a computer using the MONTAGE as a tone generator

The instructions below show how to use this instrument as a MIDI tone generator. In this case, actual MIDI sequence data is transmitted from DAW software on the computer, letting you take advantage of the dynamic sounds of the MONTAGE, while giving you the added benefit of saving processing power on your computer by avoiding the use of software synths.

Setting up the MONTAGE

- 1 Select the Performance to be edited.**
- 2 Touch the [Mixing] tab on the Performance Play display to call up the Mixing display.**
- 3 Set up the Mixing for Parts 1 – 16 as necessary.**

Setting up the DAW software

- 1 Set the MIDI output port of the Tracks for playing the MONTAGE to Port 1 of the MONTAGE.**
- 2 Enter the MIDI data to each Track of the DAW software on the computer.**

The tone generator settings of the part corresponding to the MIDI Track will be set in the Mixing display on the MONTAGE.

Saving/Loading Data

The Utility display provides tools for transferring the entire system setting and data (such as Performances and Live Sets) between the MONTAGE and an external USB flash memory device connected to the [USB TO DEVICE] terminal. This section explains how to save/load all the data on the user memory of this instrument as a “User” file.

Saving the settings to a USB flash memory device

- 1 Connect a USB flash memory device to the [USB TO DEVICE] terminal of this instrument.
- 2 Press the [UTILITY] button to call up the Utility display, and then touch the [Contents] tab → [Store/Save] tab in the left of the display.
- 3 Set “Content Type” to “User File.”



- 4 Select the desired directory of the USB flash memory device.

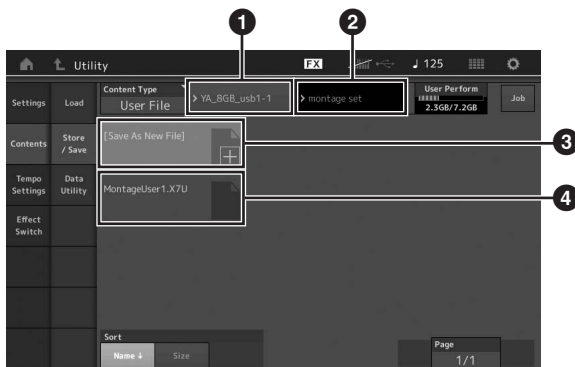

- 1 Parent folder
- 2 Store-destination folder in the USB flash memory device
- 3 New store destination
- 4 Existing files

- 5 Touch “+” in [Save As New File].

NOTE

To overwrite the existing file, touch the file name.

- 6 The Text input display appears. Input the file name to be stored.

For detailed instructions on entering a name, see “Naming (inputting characters)” in “Basic Operation and Displays” (page 17).

- 7 Touch [Done] on the Text input display to actually execute the Store operation.

NOTE

To overwrite the existing file, select “YES” on the display which prompts you for confirmation.

Loading the settings from a USB flash memory device

NOTICE

The Load operation overwrites any data previously existing in this instrument. Important data should always be saved to a USB flash memory device connected to the [USB TO DEVICE] terminal.

- 1 Connect a USB flash memory device to the [USB TO DEVICE] terminal of this instrument.
- 2 Press the [UTILITY] button to call up the Utility display, and then touch [Contents] tab → [Load] tab at the left side of the display.
- 3 Set “Content Type” to “User File.”
- 4 Select the desired folder of the USB flash memory device.
- 5 Select the file (extension: .X7U) of the memory to execute the Load operation.

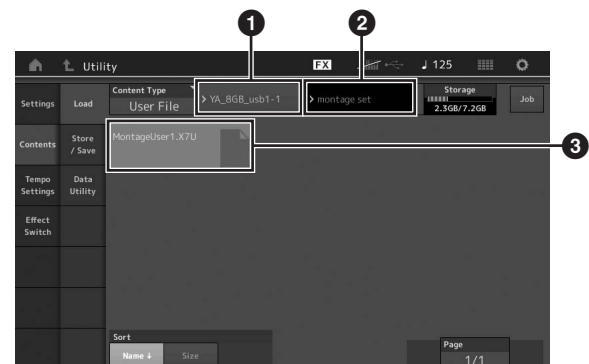

- 1 Source USB flash memory device
- 2 Source folder in the USB flash memory device
- 3 Existing files

Precautions when using the [USB TO DEVICE] terminal

This instrument features a built-in [USB TO DEVICE] terminal. When connecting a USB device to the terminal, be sure to handle the USB device with care. Follow the important precautions below.

NOTE

For more information about the handling of USB devices, refer to the owner's manual of the USB device.

Compatible USB devices

- USB flash drive

Other USB devices such as a USB hub, computer keyboard or mouse cannot be used.

The instrument does not necessarily support all commercially available USB devices. Yamaha cannot guarantee operation of USB devices that you purchase. Before purchasing a USB device for use with this instrument, please visit the following web page:
<http://download.yamaha.com/>

Although USB devices 1.1 to 3.0 can be used on this instrument, the amount of time for saving to or loading from the USB device may differ depending on the type of data or the status of the instrument.

NOTE

The rating of the USB TO DEVICE terminal is a maximum of 5V/500mA. Do not connect USB devices having a rating above this, since this can cause damage to the instrument itself.

Connecting USB device

When connecting a USB device to the [USB TO DEVICE] terminal, make sure that the connector on the device is appropriate and that it is connected in the proper direction.

NOTICE

- **Avoid connecting or disconnecting the USB device during playback/recording and file management operations (such as Save, Copy, Delete and Format), or when accessing the USB device. Failure to observe this may result in "freezing" of the operation of the instrument or corruption of the USB device and the data.**
- **When connecting then disconnecting the USB device (and vice versa), make sure to wait a few seconds between the two operations.**

Using USB flash drives

By connecting the instrument to a USB flash drive, you can save data you've created to the connected device, as well as read data from the connected device.

Maximum number of USB flash drives allowed

Up to only one USB flash drive can be connected to the [USB TO DEVICE] terminal.

Formatting USB flash drive

You should format the USB flash drive only with this instrument. A USB flash drive formatted on another device may not operate properly.

NOTICE

The format operation overwrites any previously existing data. Make sure that the USB flash drive you are formatting does not contain important data.

NOTE

For details about the format, see the Reference Manual PDF document.

To protect your data (write-protect)

To prevent important data from being inadvertently erased, apply the write-protect provided with each USB flash drive. If you are saving data to the USB flash drive, make sure to disable write-protect.

Turning off the instrument

When turning off the instrument, make sure that the instrument is NOT accessing the USB flash drive by playback/recording or file management (such as during Save, Copy, Delete and Format operations). Failure to do so may corrupt the USB flash drive and the data.

Shift Function List

Some of the important functions and operations on the instrument can be executed with convenient panel control shortcuts. Simply hold down the [SHIFT] button and press the indicated button (as described below).

| Operation | Function |
|-----------------------------------|---|
| [SHIFT] + KNOB POSITION [1] | Stores Assign 1 – 8 assigned to Knobs in Value 1. |
| [SHIFT] + KNOB POSITION [2] | Stores Assign 1 – 8 assigned to Knobs in Value 2. |
| [SHIFT] + OCTAVE [-] | Decreases the transpose value by 1. |
| [SHIFT] + OCTAVE [+] | Increases the transpose value by 1. |
| [SHIFT] + OCTAVE [-] + OCTAVE [+] | Resets the transpose value to 0. |
| [SHIFT] + [DEC/NO] | Decreases the selected parameter value by 10. |
| [SHIFT] + [INC/YES] | Increases the selected parameter value by 10. |
| [SHIFT] + [ENTER] | Calls up the Tempo Setting display. |
| [SHIFT] + [PERFORMANCE] | Calls up the Overview display. |
| [SHIFT] + [LIVE SET] | Calls up the Live Set Register display. |
| [SHIFT] + [UTILITY] | Calls up the Quick Setup display. |
| [SHIFT] + [CATEGORY SEARCH] | Calls up the Part Category Search display for the currently selected Part. |
| [SHIFT] + [PERFORMANCE CONTROL] | Sets for Performance Control. Selects Part 9 if any Part other than Part 9 has been selected. |
| [SHIFT] + SCENE [1] – [8] | Stores SCENE 1 – 8 in SCENE [1] – [8] buttons. |
| [SHIFT] + Number A [1] | Selects the 1st row and the 1st column of the left tab. |
| [SHIFT] + Number A [2] | Selects the 1st row and the 2nd column of the left tab. |
| [SHIFT] + Number A [3] | Selects the 1st row and the 3rd column of the left tab. |
| [SHIFT] + Number A [4] | Selects the 1st row and the 4th column of the left tab. |
| [SHIFT] + Number A [5] | Selects the 1st row and the 5th column of the left tab. |
| [SHIFT] + Number A [6] | Selects the 1st row and the 6th column of the left tab. |
| [SHIFT] + Number A [9] | Selects the 2nd row and the 1st column of the left tab. |
| [SHIFT] + Number A [10] | Selects the 2nd row and the 2nd column of the left tab. |
| [SHIFT] + Number A [11] | Selects the 2nd row and the 3rd column of the left tab. |
| [SHIFT] + Number A [12] | Selects the 2nd row and the 4th column of the left tab. |
| [SHIFT] + Number A [13] | Selects the 2nd row and the 5th column of the left tab. |
| [SHIFT] + Number A [14] | Selects the 2nd row and the 6th column of the left tab. |
| [UTILITY] + [PART COMMON] | Calls up the Touch Panel Calibration Setting display. |

Display Messages

| LCD indication | Description |
|---|--|
| ** will be deleted. | This message appears when the specified operation you are about to execute will cause the specified data to be deleted. |
| ** will be overwritten. | This message appears when a file/folder having the same name as the one you are about to save already exists. |
| Activate the source controller to assign. | You can assign the parameter to the controller you are about to activate. |
| Advanced settings will be initialized. | All settings executed in [Advanced] tab will be initialized. |
| All data and libraries will be initialized. Unsaved user data will be lost. | All data and libraries will be initialized. Unsaved user data will be lost. |
| All data is initialized upon power-on. | All data is initialized upon power-on. |
| All settings will be initialized. User data is kept. | All settings will be initialized. User data is kept. |
| All sound will be stopped during optimization. | This message appears before the internal memory is restored. All sound will be stopped during the optimization. |
| All user data will be initialized. Unsaved user data will be lost. | All user data will be initialized. Unsaved user data will be lost. |
| Are you sure? | Confirms whether you want to execute a specified operation or not. |
| Audio Rec stopped due to lack of memory space. | The USB flash memory device is full and no more audio recording data can be saved. Use a new USB flash memory device, or make space by erasing unwanted data from the USB flash memory device. |
| Auto power off disabled. | This message appears before Auto Power Off is disabled. |
| Bulk data protected. | Bulk data cannot be received because of the setting. |
| Can't process. | The MONTAGE cannot process a requested operation. |
| Completed. | The specified load, save, format, or other Job has been completed. |
| Connecting to USB device... | Currently recognizing the USB flash memory device connected to the [USB TO DEVICE] terminal. |
| Copy protected. | You have attempted to export or save a copy-protected digital audio source. |
| Current user data will be overwritten by **. | This message appears when saving a file, and user data under that name already exists. |
| Data memory full. | The internal memory is full, preventing storing of the recorded data in the Library. |
| Device number is off. | Bulk data cannot be transmitted/received since the device number is off. |
| Device number mismatch. | Bulk data cannot be transmitted/received since the device numbers do not match. |
| File is not found. | The specified file was not found during a Load operation. |
| File or folder already exists. | A file/folder having the same name as the one you are about to save already exists. |
| File or folder path is too long. | The file or folder you tried to access cannot be accessed because the maximum amount of characters indicating the path has been exceeded. |
| Folder is not empty. | You have attempted to delete a folder that contains data. |
| Illegal bulk data. | An error occurred while receiving a Bulk data or Bulk Request message. |
| Illegal file name. | The specified file name is invalid. Try entering a different name. |
| Illegal file. | The specified file is unusable by this synthesizer or cannot be loaded. |
| Keybank full. | The maximum overall number of Key Banks has been exceeded when executing a Load operation. |
| Library full. | The maximum overall number of Libraries has been exceeded when executing the related operations. |
| MIDI buffer full. | Failed to process the MIDI data because too much data was received at one time. |
| MIDI checksum error. | An error occurred when receiving bulk data. |
| No data. | This message appears when the selected track or range contains no data. Select an appropriate track or range. |

| LCD indication | Description |
|---|---|
| No read/write authority to the file. | Indicates that you do not have the authority to read/write the file. |
| Now initializing all data... | Indicates this synthesizer is restoring the factory-programmed settings. |
| Now initializing... | Indicates that the specified data is being initialized. |
| Now loading... | Indicates that a file is being loaded. |
| Now receiving MIDI bulk data... | Indicates this synthesizer is receiving MIDI bulk data. |
| Now saving... | Indicates that a file is being saved. |
| Now transmitting MIDI bulk data... | Indicates this synthesizer is transmitting MIDI bulk data. |
| Please connect USB device. | Connect the USB device to the [USB TO DEVICE] terminal for audio recording. |
| Please keep power on. | The data is being written to Flash ROM. Never attempt to turn off the power while data is being written to Flash ROM. Turning the power off while this message is shown results in loss of all user data and may cause the system to freeze (due to corruption of data in the Flash ROM). This may also result in the MONTAGE being unable to properly start up the next time the power is turned on. |
| Please reboot to enable the new Audio I/O Mode. | Please reboot this synthesizer to activate the change of the input/output settings for audio data. |
| Please reboot to maintain internal memory. | Please reboot this synthesizer to restore the internal memory. |
| Please stop audio play/rec. | The operation you have attempted to execute cannot be done during audio recording or playback. |
| Please stop sequencer. | The operation you have attempted to execute cannot be done during Song playback. |
| Please wait... | Indicates this synthesizer is executing the specified operation. |
| Recall latest edits. | If you are editing a Performance and select a different Performance without storing your edited one, all the edits you've made will be erased. If this happens, you can use Recall to restore the Performance with your latest edits intact. |
| Redo last recording. | Confirms whether you want to redo the operation you have undone. |
| Sample is protected. | The sample data cannot be overwritten. |
| Sample is too long. | The Sample size is too large and the Load operation cannot be executed. |
| Sample memory full. | The Sample memory is full and further Load operations cannot be executed. |
| Scene stored. | The Scene has been stored to one of the [SCENE] buttons. |
| Song data overload. | The Song size is too large for playback. |
| Song full. | The maximum overall number of Songs has been exceeded when executing the related operations. |
| Touch the white square. | This message appears when you need to touch the displayed white rectangle during touch panel calibration. |
| Turn on Memory Switch to memorize ** into this scene. | When the [Memory] (Memory Switch) is turned on for the function, the corresponding function information is automatically stored in the currently selected [SCENE] button. |
| Undo last recording. | Confirms whether you want to undo the most recent recording. |
| Unsupported USB device. | This message appears when an unsupported USB device has been connected. |
| USB connection terminated. | A break in the connection with the USB flash memory device has occurred because of an abnormal electric current. Disconnect the USB flash memory device from the [USB TO DEVICE] terminal, and then press any of the panel buttons. |
| USB device is full. | The USB flash memory device is full and no more data can be saved. Use a new USB flash memory device, or make space by erasing unwanted data from the storage device. |
| USB device is write-protected. | This message appears when you have attempted to write to a protected USB flash memory device. |
| USB device read/write error. | An error occurred while reading or writing to/from a USB flash memory device. |
| USB device will be formatted. | This message appears before the USB device is formatted. |
| Waveform full. | The maximum overall number of Waveforms has been exceeded when executing the related operations. |

Troubleshooting

No sound? Wrong sound? When a problem like this occurs, please check the following points before assuming that the product is faulty. Many problems can be solved by executing Data Initialization (page 15), after backing up your data to an USB flash memory device (page 53). If the problem persists, consult your Yamaha dealer.

Touch panel does not respond correctly.

- Is the point you touch on the touch panel lined up properly with the target item in the display underneath?
Calibrate the touch panel.

[UTILITY] + PART [COMMON] → [ENTER]

[UTILITY] → [Settings] → [System] → [Calibrate Touch Panel]

No Sound.

- Are all sliders set to appropriate levels (other than zero or minimum)?
- Is the MONTAGE properly connected to related external equipment (e.g., amplifier, speaker, headphones) via audio cables?
Since the MONTAGE has no built-in speakers, you will need an external audio system or a set of stereo headphones to properly monitor it (page 14).
- Is the power of this synthesizer and any external equipment connected to this synthesizer turned on?
- Have you made all the appropriate level settings—including the Master Volume on this synthesizer and the volume settings on any connected external equipment?
When the Foot Controller is connected to the [FOOT CONTROLLER] jack, press the Foot Controller down.
- Is the Local Control parameter set to off?
When the Local Control parameter is set to off, no sound is produced even if you play the keyboard.

[UTILITY] → [Settings] → [MIDI I/O] → "Local Control"

- Is a blank Part selected?
If so, assign any sound to the Part or select another Part.
- Is the Mute switch for each Part turned on?
When the Mute switch is turned on, no sound is produced even if you play the keyboard.

[PERFORMANCE] → Part selection → "Mute"

- Is the Keyboard Control of each Part turned off?

[PERFORMANCE] → Part selection → "Kbd Ctrl"

- Is the "Arp Play Only" parameter of each Part turned on?
When this parameter is turned on, the corresponding Part produces sound only via Arpeggio playback.

[EDIT] → Part selection → ELEMENT/OPERATOR [COMMON] → [Part Settings] → [General] → "Arp Play Only"

[EDIT] → Part selection → ELEMENT/OPERATOR [COMMON] → [Arpeggio] → [Common] → "Arp Play Only"

- Are the MIDI volume or MIDI expression settings too low when using the external controller?
- Are the effect and filter settings appropriate?
If you are using a filter, try changing the cutoff frequency. Some cutoff settings may filter out all of the sound.

[EDIT] → PART [COMMON] → [Effect]

[EDIT] → Part selection → ELEMENT/OPERATOR [COMMON] → [Effect]

- In case of Normal Part (AWM2) and Drum Part

[EDIT] → Part selection → Element/Key selection → [Filter]

- In case of Normal Part (FM-X)

[EDIT] → Part selection → ELEMENT/OPERATOR [COMMON] → [Pitch/Filter]

- Is "Vocoder" selected as the Insertion Effect Type of the Part?
If so, set the parameters related to the A/D INPUT [L/MONO]/[R] jack to the appropriate values then play the keyboard while inputting your voice into the microphone connected to the MONTAGE. Check whether or not the A/D INPUT [GAIN] Knob on the rear panel is set to the minimum position.

[EDIT] → Part selection → ELEMENT/OPERATOR [COMMON] → [Effect] → [Routing]

- Are the volume or expression settings too low?
 - [UTILITY] → [Settings] → [Sound] → Tone Generator "Volume"
 - [EDIT] → PART [COMMON] → [General] → "Volume"
 - [EDIT] → Part selection → ELEMENT/OPERATOR [COMMON] → [Part Settings] → [General] → "Volume"
 - [EDIT] → Part selection → ELEMENT/OPERATOR [COMMON] → [Part Settings] → [General] → "Dry Level"
- In case of Normal Part (AWM2) and Drum Part
 - [EDIT] → Part selection → Element/Key selection → [Amplitude] → [Level/Pan] → "Level"
- In case of Normal Part (FM-X)
 - [EDIT] → Part selection → Operator selection → [Level] → "Level"
- Are the parameter settings such as Element Switch, Note Limit, Velocity Limit, and Velocity Offset appropriate?
 - In case of Normal Part (AWM2) and Drum Part
 - [EDIT] → Part selection → ELEMENT/OPERATOR [COMMON] → [Part Settings] → [General]
 - [EDIT] → Part selection → Element/Key selection → [Osc/Tune]
 - In case of Normal Part (FM-X)
 - [EDIT] → Part selection → ELEMENT/OPERATOR [COMMON] → [Part Settings] → [General]
- Is the Mute switch for each Element/Operator of Part turned on?
 - [EDIT] → Part selection → Mute Switch of each Element/Operator
- In case of Normal Part (FM-X), is the Carrier Level is set to "0"?
 - [EDIT] → Part selection → Operator selection → [Level] → "Level"
- Is the output parameter of each Part turned off?
 - [EDIT] → Part selection → ELEMENT/OPERATOR [COMMON] → [Part Settings] → [General] → "Part Output"

No sound from the A/D INPUT jack.

- Is the switch of the microphone turned on?
- Check the microphone type. Make sure to use a dynamic microphone.
- Is the cable between the microphone or audio equipment and this instrument properly connected?
- Is the A/D INPUT [GAIN] knob turned to the minimum?
- Is the A/D INPUT [ON/OFF] button turned on?
- Check whether or not the connection status of the A/D INPUT [L/MONO]/[R] matches the "Mono/Stereo" parameter.
 - [EDIT] → PART [COMMON] → [Audio In] → [Mixing] → A/D In "Input Mode"
- Check whether or not the "Mic/Line" parameter is set to the appropriate value.

When the output level of the connected equipment (such as a microphone) is low, set this parameter to "Mic." When the output level of the connected equipment (such as a synthesizer keyboard, CD player) is high, set this parameter to "Line."

 - [UTILITY] → [Settings] → [Audio I/O] → "A/D Input"
- Are the volume settings of the A/D Input Part too low?
 - [EDIT] → PART [COMMON] → [Audio In] → [Mixing] → A/D In "Volume"
- Are the effect settings appropriate?
 - [EDIT] → PART [COMMON] → [Audio In] → [Routing]
- Is the output setting of the A/D Input Part set appropriately?
 - [UTILITY] → [Settings] → [Audio I/O] → Output
- Check whether or not the Vocoder Effect is selected.

When Vocoder is selected as the Insertion Effect for the current Part, the audio signal input from the A/D INPUT [L/MONO]/[R] jacks may not produce any sound depending on the parameter settings.

 - [EDIT] → Part selection → ELEMENT/OPERATOR [COMMON] → [Effect] → [Routing]

Playback continues without stopping.

- When the [ARP ON/OFF] button is turned on, press it so that the button is turned off.
- When in the Song display, press the [■] (Stop) button.
- When the effect sound such as Delay continues, check the effect setting or select the Performance again.
- When the click sound continues, check the following parameter setting. Set this parameter to something other than “always,” since this setting always plays back the click sound regardless of the sequencer status.

[UTILITY] → [Tempo Settings] → Click “Mode”

Distorted sound.

- Are the effect settings appropriate?
Use of an effect at certain settings may produce distortion.

[EDIT] → Part selection → ELEMENT/OPERATOR [COMMON] → [Effect]

- Are the filter settings appropriate?
Excessively high filter resonance settings can cause distortion.

- In case of Normal Part (AWM2) and Drum Part

[EDIT] → Part selection → Element/Key selection → [Filter]

- In case of Normal Part (FM-X)

[EDIT] → Part selection → ELEMENT/OPERATOR [COMMON] → [Pitch/Filter]

- Are any of the following volume parameters set so high that clipping is occurring?

[UTILITY] → [Settings] → [Sound] → Tone Generator “Volume”

[UTILITY] → [Settings] → [Audio I/O] → “Output”

[EDIT] → PART [COMMON] → [General] → “Volume”

[EDIT] → Part selection → ELEMENT/OPERATOR [COMMON] → [Part Settings] → [General] → “Volume”

- In case of Normal Part (AWM2) and Drum Part

[EDIT] → Part selection → Element/Key selection → [Amplitude] → [Level/Pan] → “Level”

- In case of Normal Part (FM-X)

[EDIT] → Part selection → Operator selection → [Level] → “Level”

Sound is cut off.

- Is the entire sound (via your keyboard playback and Song/Part/Arpeggio playback) exceeding the maximum polyphony (128 for each of AWM2 and FM-X) of the MONTAGE?

Only one note sounds at a time.

- When this situation occurs, the Mono/Poly parameter in the current mode is set to “mono.”
If you wish to play chords, set this parameter to “poly.”

[EDIT] → Part selection → ELEMENT/OPERATOR [COMMON] → [Part Settings] → [General] → “Mono/Poly”

Pitch or intervals are wrong.

- Is the Master Tune parameter of each Part set to a value other than “0”?

[UTILITY] → [Settings] → [Sound] → Tone Generator “Tune”

- Is the Note Shift parameter of each Part set to a value other than “0”?

- In case of Normal Part (AWM2) and Drum Part

[EDIT] → Part selection → ELEMENT/OPERATOR [COMMON] → [Part Settings] → [Pitch] → “Note Shift”

[EDIT] → Part selection → ELEMENT/OPERATOR [COMMON] → [Part Settings] → [Pitch] → “Detune”

- In case of Normal Part (FM-X)

[EDIT] → Part selection → ELEMENT/OPERATOR [COMMON] → [Pitch/Filter] → [Pitch] → “Note Shift”

[EDIT] → Part selection → ELEMENT/OPERATOR [COMMON] → [Pitch/Filter] → [Pitch] → “Detune”

■ When the Part produces a wrong pitch, is the appropriate tuning system selected from the Micro Tuning parameter?

- In case of Normal Part (AWM2) and Drum Part

[EDIT] → Part selection → ELEMENT/OPERATOR [COMMON] → [Part Settings] → [Pitch] → “Micro Tuning Name”

- In case of Normal Part (FM-X)

[EDIT] → Part selection → ELEMENT/OPERATOR [COMMON] → [Pitch/Filter] → [Pitch] → “Micro Tuning Name”

■ When the Part produces a wrong pitch, is the LFO Pitch Modulation Depth set too high?

- In case of Normal Part (AWM2)

[EDIT] → Part selection → Element selection → [Element LFO] → “Pitch Mod”

- In case of Normal Part (FM-X)

[EDIT] → Part selection → ELEMENT/OPERATOR [COMMON] → [Mod/Control] → [2nd LFO] → “Pitch Modulation”

■ When a Part produces a wrong pitch, are Coarse tune and Fine tune settings appropriate?

- In case of Normal Part (AWM2) and Drum Part

[EDIT] → Part selection → Element/Key selection → [Osc/Tune] → “Coarse”

[EDIT] → Part selection → Element/Key selection → [Osc/Tune] → “Fine”

- In case of Normal Part (FM-X)

[EDIT] → Part selection → Operator selection → [Form/Freq] → “Coarse”

[EDIT] → Part selection → Operator selection → [Form/Freq] → “Fine”

■ When the Part seems to produce the wrong pitch, is the destination of the controller set to “Pitch”?

[EDIT] → Part selection → [Mod/Control] → [Control Assign] → “Destination”

No effect is applied.

■ Is the Effect Switch turned off?

[UTILITY] → [Effect Switch]

■ Is the Variation Send or Reverb Send set to a value other than “0”?

[EDIT] → Part selection → ELEMENT/OPERATOR [COMMON] → [Effect] → [Routing] → “Var Send”

[EDIT] → Part selection → ELEMENT/OPERATOR [COMMON] → [Effect] → [Routing] → “Rev Send”

■ Is the Variation Return or Reverb Return set to a value other than “0”?

[EDIT] → PART [COMMON] → [Effect] → [Routing] → “Var Return”

[EDIT] → PART [COMMON] → [Effect] → [Routing] → “Rev Return”

■ Have any or all of the Element/Keys' Insertion Effect Output parameters been set to “thru” in the effect setting?

[EDIT] → Part selection → ELEMENT/OPERATOR [COMMON] → [Effect] → [Routing] → “Element 1-8”

■ In case of System Effect, have any or all of the effect types been set to “No Effect”?

■ In case of Insertion Effect, have any or all of the effect types been set to “Thru”?

■ Check whether the Insertion Switch parameters are set properly or not.

[EDIT] → Part selection → ELEMENT/OPERATOR [COMMON] → [Effect] → [Ins A]/[Ins B]

Cannot start the Arpeggio.

■ Check whether the [ARP ON/OFF] button is turned on or off.

■ Count the number of Parts whose Arpeggio switches are turned on.
You can play back the Arpeggios of up to eight Parts simultaneously.

■ Are the Arpeggio related parameters such as Note Limit and Velocity Limit set appropriately?

[EDIT] → Part selection → ELEMENT/OPERATOR [COMMON] → [Arpeggio] → [Common]

■ Is the Arpeggio Type parameter set to “off”?

[EDIT] → Part selection → [Arpeggio] → [Individual] → “Name”

- Check the Arpeggio Switch parameter.

If this parameter for the current Part is set to off, Arpeggio playback will not be triggered by your keyboard performance even if the [ARP ON/OFF] button is turned on.

[PERFORMANCE] → Part selection → "Arp On"

Cannot stop the Arpeggio.

- When Arpeggio playback does not stop even if you release the key, set the Arpeggio Hold parameter to "off."

[EDIT] → Part selection → ELEMENT/OPERATOR [COMMON] → [Arpeggio] → [Common] → "Hold"

The Song cannot be started even when pressing the [▶] (Play) button.

- Does the selected Song actually contain data?

Song cannot be recorded.

- Is there enough free memory for recording?

MONTAGE memory can record up to 64 Songs. If the memory becomes full, no more recording is possible.

Data communication between the computer and the MONTAGE does not work properly.

- Check whether the Port settings on the computer are appropriate or not.
- Check whether or not the MIDI IN/OUT parameter is set to the appropriate value.

[UTILITY] → [Settings] → [MIDI I/O] → MIDI "MIDI IN/OUT"

MIDI bulk data transmission/reception does not work properly.

- Is the Receive Bulk parameter set to off?

Set the Receive Bulk parameter to on.

[UTILITY] → [Settings] → [Advanced] → MIDI "Receive Bulk"

- When receiving MIDI bulk data transmitted via the Bulk Dump function and recorded to the external MIDI device, you need to set the MIDI Device Number to the same value as when transmitting.

[UTILITY] → [Settings] → [Advanced] → MIDI "Device Number"

When transmission does not work properly, is the device number of the MIDI instrument connected to the MONTAGE set to match the Device Number parameter?

[UTILITY] → [Settings] → [Advanced] → MIDI "Device Number"

Cannot save data to the external USB flash memory device.

- Is the USB flash memory device being used write protected? (Write-protect should be set to off for saving data.)

- Is there enough free space on the USB flash memory device?

In the Contents display, set the device to the USB flash memory device. Check the amount of currently available (unused) memory of the USB flash memory device indicated at the right top of the display.

[UTILITY] → [Contents] → [Load]/[Store/Save]

- Is operation of the particular USB flash memory device guaranteed by Yamaha?
For details, see page 54.

In the display, there are some black points (unlit) or white points (always lit).

- These are the result of defective pixels and occasionally occur in LCDs; they do not indicate a problem in operation.

Specifications

| | | | |
|-----------------------------|------------------------|---|--|
| Keyboards | | MONTAGE8: 88 keys, Balanced Hammer Effect Keyboard (Initial Touch/Aftertouch) MONTAGE7: 76 keys, FSX Keyboard (Initial Touch/Aftertouch) MONTAGE6: 61 keys, FSX Keyboard (Initial Touch/Aftertouch) | |
| Tone Generator block | Tone Generator | Motion Control Synthesis Engine AWM2: 8 Elements FM-X: 8 Operators, 88 Algorithms | |
| | Polyphony | AWM2: 128 (max.; stereo/mono waveforms) FM-X: 128 (max.) | |
| | Multi Timbral Capacity | 16 Parts (internal), Audio Input Parts (A/D ^{*1} , USB ^{*1}) *1 stereo Part | |
| | Waveforms | Preset: 5.67 GB (when converted to 16-bit linear format), User: 1.75 GB | |
| | Performances | Approx. 1,900 | |
| | Filters | 18 types | |
| | Effect System | Reverb x 12 types, Variation x 76 types, Insertion (A, B) x 76 types ^{*2} , Master Effect x 15 types *2 A/D part insertion x 71 types <Preset settings for parameters of each effect type are provided as templates> Master EQ (5 bands), 1st part EQ (3 bands), 2nd part EQ (2 bands) | |
| Sequencer block | Note Capacity | Approx. 130,000 notes | |
| | Note Resolution | 480 ppq (parts per quarter note) | |
| | Tempo (BPM) | 5 – 300 | |
| | Performance Recorder | Songs | 64 songs |
| | | Tracks | 16 Sequence tracks, Tempo track, Scene track |
| | | Recording type | Real time replace, Real time overdub, Real time punch in/out |
| | Sequence Format | MONTAGE original format, SMF formats 0, 1 | |
| | Arpeggio | Part | 8 Parts simultaneous (max.) |
| | | Preset | Approx. 10,000 types |
| | | User | 256 types |
| Motion Sequencer | Lane | 8 + 1 Lanes (max.) | |
| Others | Live Sets | Preset: 128 and more, User: 2,048 | |
| | Controllers | Master Volume, AD Input Gain knob, Pitch Bend wheel, Modulation wheel, Ribbon Controller, Control Sliders x 8, Knobs x 8, Super Knob, Data dial | |
| | Display | 7" TFT Color Wide VGA LCD touch screen | |
| | Connectors | [USB TO DEVICE], [USB TO HOST], MIDI [IN]/[OUT]/[THRU], FOOT CONTROLLER [1]/[2], FOOT SWITCH [ASSIGNABLE]/[SUSTAIN], OUTPUT (BALANCED) [L/MONO]/[R] (6.3 mm, Balanced TRS jacks), ASSIGNABLE OUTPUT (BALANCED) [L]/[R] (6.3 mm, Balanced TRS jacks), [PHONES] (6.3 mm, standard stereo phone jack), A/D INPUT [L/MONO]/[R] (6.3 mm, standard phone jacks) | |
| | Dimensions, Weight | MONTAGE8: 1,450 (W) x 470 (D) x 160 (H) mm (57-1/16" x 18-1/2" x 6-5/16"), 29 kg (63 lbs., 15 oz.) MONTAGE7: 1,244 (W) x 396 (D) x 131 (H) mm (49" x 15-9/16" x 5-3/16"), 17 kg (37 lbs., 8 oz.) MONTAGE6: 1,037 (W) x 396 (D) x 131 (H) mm (40-13/16" x 15-9/16" x 5-3/16"), 15 kg (33 lbs., 1 oz.) | |
| | Accessories | AC Power cord, Owner's Manual (this book), Cubase AI Download Information | |

Specifications and descriptions in this owner's manual are for information purposes only. Yamaha Corp. reserves the right to change or modify products or specifications at any time without prior notice. Since specifications, equipment or options may not be the same in every locale, please check with your Yamaha dealer. Visit the web page for information on the latest Owner's manual.

Index

A

| | |
|---|--------|
| A/D INPUT [GAIN] knob | 7 |
| A/D INPUT [L/MONO]/[R] jacks | 12, 44 |
| A/D INPUT [ON/OFF] button | 7 |
| ABS (Audio Beat Sync) | 12, 13 |
| [AC IN] (AC Power Cord Socket) | 12 |
| [ARP ON/OFF] (Arpeggio on/off) button | 7, 24 |
| Arpeggio | 24 |
| Arpeggio type | 38 |
| [ASSIGN] button | 8 |
| [ASSIGN 1] and [ASSIGN 2] buttons (Assignable switches 1 and 2) | 6 |
| ASSIGNABLE OUTPUT (BALANCED) [L] and [R] jacks (TRS balanced output) | 12 |
| Audio channels | 50 |
| Audio Recording | 41 |
| [AUDITION] button | 10, 21 |
| Audition phrase | 21 |

C

| | |
|---|--------|
| Carrier | 33 |
| Category Search | 20 |
| [CATEGORY SEARCH] button | 9 |
| Click | 40 |
| Compare function | 35 |
| Connecting a Computer | 49 |
| Connecting external MIDI instrument | 48 |
| [CONTROL ASSIGN] button | 8 |
| Control Sliders | 8 |
| Controllers | 26 |
| Cubase | 49, 63 |
| Cursor | 9, 16 |

D

| | |
|------------------------|-------|
| Data dial | 8 |
| DAW software | 51 |
| [DEC/NO] button | 9, 17 |
| Display Messages | 56 |
| Drum Parts | 18 |

E

| | |
|--|----|
| [EDIT] button | 9 |
| Effect | 34 |
| EFFECT icon | 16 |
| Element | 33 |
| Element Common Edit | 33 |
| Element Edit | 33 |
| ELEMENT/OPERATOR [COMMON] button | 10 |
| ELEMENT/OPERATOR [MUTE] button | 10 |
| ELEMENT/OPERATOR [SOLO] button | 10 |
| [ENTER] button | 9 |
| Envelope Follower | 12 |
| [EXIT] button | 9 |

F

| | |
|------------|----|
| Flag | 19 |
|------------|----|

| | |
|--|----|
| FOOT CONTROLLER [1]/[2] jack | 12 |
| FOOT SWITCH [ASSIGNABLE]/[SUSTAIN] jacks | 12 |
| Format | 54 |

G

| | |
|---------------|----|
| GM Bank | 18 |
|---------------|----|

H

| | |
|------------------|----|
| Headphones | 14 |
|------------------|----|

I

| | |
|--|-------|
| [INC/YES] button | 9, 17 |
| Inputting characters | 17 |
| Inputting using the keys on the keyboard | 17 |

K

| | |
|---|-------|
| Key Common Edit | 33 |
| Key Edit | 33 |
| Keyboard | 6 |
| Knob Function | 7, 27 |
| KNOB POSITION [1] and [2] buttons | 8 |
| Knobs | 8, 27 |

L

| | |
|-------------------------|----|
| Layer | 35 |
| Library Banks | 18 |
| Live Set | 19 |
| [LIVE SET] button | 9 |
| Load | 53 |

M

| | |
|--|-------|
| Master Keyboard | 43 |
| [MASTER VOLUME] slider | 6, 15 |
| Microphone | 44 |
| MIDI channels | 50 |
| MIDI [IN], [OUT], [THRU] terminal | 12 |
| MIDI ports | 50 |
| MIDI Recording | 39 |
| MIDI Transmit Channel | 48 |
| Mixing | 28 |
| Modulation wheel | 6 |
| [MOTION SEQ HOLD] (Motion Sequencer hold) button | 6 |
| [MOTION SEQ ON/OFF] (Motion Sequencer on/off) button | 7, 25 |
| [MOTION SEQ TRIGGER] (Motion Sequencer trigger) button | 6 |
| Motion Sequencer | 25 |
| [MULTI] (Multi Part control) button | 7 |
| Mute | 23 |

N

| | |
|-----------------------------------|----|
| Name | 17 |
| Normal Parts (AWM2) | 18 |
| Normal Parts (FM-X) | 18 |
| Number A [1] – [16] buttons | 10 |
| Number B [1] – [8] buttons | 10 |
| Number C [1] – [8] buttons | 10 |
| Numeric keypad display | 17 |

O

| | |
|---|----|
| OCTAVE [-] and [+] button | 8 |
| Operator Common Edit | 33 |
| Operator Edit | 33 |
| Operators | 33 |
| OUTPUT (BALANCED) [L/MONO] and [R] jacks (TRS balanced output) | 12 |

P

| | |
|------------------------------------|-------|
| Part | 23 |
| PART [COMMON] button | 10 |
| [PART CONTROL] button | 9 |
| Part Editing | 33 |
| PART [MUTE] button | 10 |
| PART [SOLO] button | 10 |
| [PERFORMANCE] button | 9, 22 |
| [PERFORMANCE CONTROL] button | 9 |
| Performance Editing | 32 |
| Performance Play | 22 |
| [PHONES] (Headphone) jack | 12 |
| Pitch Bend wheel | 6 |
| Power on Mode | 45 |
| Power Supply | 14 |
| Preset Banks | 18 |
| Punch In/Out | 40 |

Q

| | |
|-------------------|----|
| Quick Setup | 49 |
|-------------------|----|

R

| | |
|--|----|
| Record | 39 |
| Restoring the initial factory settings | 15 |
| Ribbon Controller | 6 |

S

| | |
|-------------------------------|-------|
| Save | 53 |
| SCENE [1] – [8] buttons | 8, 29 |
| Scene function | 29 |
| SEQ TRANSPORT button | 8 |
| [SHIFT] button | 9 |
| Shift Function List | 55 |
| Solo | 23 |
| Song | 39 |
| Split | 35 |
| SSS | 19 |
| [STANDBY/ON] switch | 12 |
| Store | 32 |
| [STORE] button | 9 |
| Super Knob | 8, 28 |

T

| | |
|-----------------------|----|
| Touch panel LCD | 8 |
| Track | 39 |

U

| | |
|--------------------------------|--------|
| USB flash memory device | 53 |
| [USB TO DEVICE] terminal | 12, 54 |
| [USB TO HOST] terminal | 12, 50 |
| User Banks | 18 |
| [UTILITY] button | 9 |
| Utility display | 45 |

V

| | |
|--------------|----|
| Volume | 15 |
|--------------|----|

Y

| | |
|-----------------------------------|----|
| Yamaha Steinberg USB Driver | 49 |
|-----------------------------------|----|

GNU GENERAL PUBLIC LICENSE

Version 2, June 1991

Copyright © 1989, 1991 Free Software Foundation, Inc., 51 Franklin Street, Fifth Floor, Boston, MA 02110-1301 USA
Everyone is permitted to copy and distribute verbatim copies of this license document, but changing it is not allowed.

Preamble

The licenses for most software are designed to take away your freedom to share and change it. By contrast, the GNU General Public License is intended to guarantee your freedom to share and change free software—to make sure the software is free for all its users. This General Public License applies to most of the Free Software Foundation's software and to any other program whose authors commit to using it. (Some other Free Software Foundation software is covered by the GNU Lesser General Public License instead.) You can apply it to your programs, too.

When we speak of free software, we are referring to freedom, not price. Our General Public Licenses are designed to make sure that you have the freedom to distribute copies of free software (and charge for this service if you wish), that you receive source code or can get it if you want it, that you can change the software or use pieces of it in new free programs; and that you know you can do these things.

To protect your rights, we need to make restrictions that forbid anyone to deny you these rights or to ask you to surrender the rights. These restrictions translate to certain responsibilities for you if you distribute copies of the software, or if you modify it.

For example, if you distribute copies of such a program, whether gratis or for a fee, you must give the recipients all the rights that you have. You must make sure that they, too, receive or can get the source code. And you must show them these terms so they know their rights.

We protect your rights with two steps: (1) copyright the software, and (2) offer you this license which gives you legal permission to copy, distribute and/or modify the software.

Also, for each author's protection and ours, we want to make certain that everyone understands that there is no warranty for this free software. If the software is modified by someone else and passed on, we want its recipients to know that what they have is not the original, so that any problems introduced by others will not reflect on the original authors' reputations.

Finally, any free program is threatened constantly by software patents. We wish to avoid the danger that redistributors of a free program will individually obtain patent licenses, in effect making the program proprietary. To prevent this, we have made it clear that any patent must be licensed for everyone's free use or not licensed at all.

The precise terms and conditions for copying, distribution and modification follow.

GNU GENERAL PUBLIC LICENSE TERMS AND CONDITIONS FOR COPYING, DISTRIBUTION AND MODIFICATION

0. This License applies to any program or other work which contains a notice placed by the copyright holder saying it may be distributed under the terms of this General Public License. The "Program", below, refers to any such program or work, and a "work based on the Program" means either the Program or any derivative work under copyright law: that is to say, a work containing the Program or a portion of it, either verbatim or with modifications and/or translated into another language. (Hereinafter, translation is included without limitation in the term "modification".) Each licensee is addressed as "you".

Activities other than copying, distribution and modification are not covered by this License; they are outside its scope. The act of running the Program is not restricted, and the output from the Program is covered only if its contents constitute a work based on the Program (independent of having been made by running the Program). Whether that is true depends on what the Program does.

1. You may copy and distribute verbatim copies of the Program's source code as you receive it, in any medium, provided that you conspicuously and appropriately publish on each copy an appropriate copyright notice and disclaimer of warranty; keep intact all the notices that refer to this License and to the absence of any warranty; and give any other recipients of the Program a copy of this License along with the Program.

You may charge a fee for the physical act of transferring a copy, and you may at your option offer warranty protection in exchange for a fee.

2. You may modify your copy or copies of the Program or any portion of it, thus forming a work based on the Program, and copy and distribute such modifications or work under the terms of Section 1 above, provided that you also meet all of these conditions:

- a)** You must cause the modified files to carry prominent notices stating that you changed the files and the date of any change.
- b)** You must cause any work that you distribute or publish, that in whole or in part contains or is derived from the Program or any part thereof, to be licensed as a whole at no charge to all third parties under the terms of this License.
- c)** If the modified program normally reads commands interactively when run, you must cause it, when started running for such interactive use in the most ordinary way, to print or display an announcement including an appropriate copyright notice and a notice that there is no warranty (or else, saying that you provide a warranty) and that users may redistribute the program under these conditions, and telling the user how to view a copy of this License. (Exception: if the Program itself is interactive but does not normally print such an announcement, your work based on the Program is not required to print an announcement.)

These requirements apply to the modified work as a whole. If identifiable sections of that work are not derived from the Program, and can be reasonably considered independent and separate works in themselves, then this License, and its terms, do not apply to those sections when you distribute them as separate works. But when you distribute the same sections as part of a whole which is a work based on the Program, the distribution of the whole must be on the terms of this License, whose permissions for other licensees extend to the entire whole, and thus to each and every part regardless of who wrote it.

Thus, it is not the intent of this section to claim rights or contest your rights to work written entirely by you; rather, the intent is to exercise the right to control the distribution of derivative or collective works based on the Program.

In addition, mere aggregation of another work not based on the Program with the Program (or with a work based on the Program) on a volume of a storage or distribution medium does not bring the other work under the scope of this License.

3. You may copy and distribute the Program (or a work based on it, under Section 2) in object code or executable form under the terms of Sections 1 and 2 above provided that you also do one of the following:

- a)** Accompany it with the complete corresponding machine-readable source code, which must be distributed under the terms of Sections 1 and 2 above on a medium customarily used for software interchange; or,
- b)** Accompany it with a written offer, valid for at least three years, to give any third party, for a charge no more than your cost of physically performing source distribution, a complete machine-readable copy of the corresponding source code, to be distributed under the terms of Sections 1 and 2 above on a medium customarily used for software interchange; or,
- c)** Accompany it with the information you received as to the offer to distribute corresponding source code. (This alternative is allowed only for noncommercial distribution and only if you received the program in object code or executable form with such an offer, in accord with Subsection b above.)

The source code for a work means the preferred form of the work for making modifications to it. For an executable work, complete source code means all the source code for all modules it contains, plus any associated interface definition files, plus the scripts used to control compilation and installation of the executable. However, as a special exception, the source code distributed need not include anything that is normally distributed (in either source or binary form) with the major components (compiler, kernel, and so on) of the operating system on which the executable runs, unless that component itself accompanies the executable.

If distribution of executable or object code is made by offering access to copy from a designated place, then offering equivalent access to copy the source code from the same place counts as distribution of the source code, even though third parties are not compelled to copy the source along with the object code.

4. You may not copy, modify, sublicense, or distribute the Program except as expressly provided under this License. Any attempt otherwise to copy, modify, sublicense or distribute the Program is void, and will automatically terminate your rights under this License. However, parties who have received copies, or rights, from you under this License will not have their licenses terminated so long as such parties remain in full compliance.
5. You are not required to accept this License, since you have not signed it. However, nothing else grants you permission to modify or distribute the Program or its derivative works. These actions are prohibited by law if you do not accept this License. Therefore, by modifying or distributing the Program (or any work based on the Program), you indicate your acceptance of this License to do so, and all its terms and conditions for copying, distributing or modifying the Program or works based on it.
6. Each time you redistribute the Program (or any work based on the Program), the recipient automatically receives a license from the original licensor to copy, distribute or modify the Program subject to these terms and conditions. You may not impose any further restrictions on the recipients' exercise of the rights granted herein. You are not responsible for enforcing compliance by third parties to this License.
7. If, as a consequence of a court judgment or allegation of patent infringement or for any other reason (not limited to patent issues), conditions are imposed on you (whether by court order, agreement or otherwise) that contradict the conditions of this License, they do not excuse you from the conditions of this License. If you cannot distribute so as to satisfy simultaneously your obligations under this License and any other pertinent obligations, then as a consequence you may not distribute the Program at all. For example, if a patent license would not permit royalty-free redistribution of the Program by all those who receive copies directly or indirectly through you, then the only way you could satisfy both it and this License would be to refrain entirely from distribution of the Program.

If any portion of this section is held invalid or unenforceable under any particular circumstance, the balance of the section is intended to apply and the section as a whole is intended to apply in other circumstances.

It is not the purpose of this section to induce you to infringe any patents or other property right claims or to contest validity of any such claims; this section has the sole purpose of protecting the integrity of the free software distribution system, which is implemented by public license practices. Many people have made generous contributions to the wide range of software distributed through that system in reliance on consistent application of that system; it is up to the author/donor to decide if he or she is willing to distribute software through any other system and a licensee cannot impose that choice.

This section is intended to make thoroughly clear what is believed to be a consequence of the rest of this License.

8. If the distribution and/or use of the Program is restricted in certain countries either by patents or by copyrighted interfaces, the original copyright holder who places the Program under this License may add an explicit geographical distribution limitation excluding those countries, so that distribution is permitted only in or among countries not thus excluded. In such case, this License incorporates the limitation as if written in the body of this License.
9. The Free Software Foundation may publish revised and/or new versions of the General Public License from time to time. Such new versions will be similar in spirit to the present version, but may differ in detail to address new problems or concerns.
Each version is given a distinguishing version number. If the Program specifies a version number of this License which applies to it and "any later version", you have the option of following the terms and conditions either of that version or of any later version published by the Free Software Foundation. If the Program does not specify a version number of this License, you may choose any version ever published by the Free Software Foundation.
10. If you wish to incorporate parts of the Program into other free programs whose distribution conditions are different, write to the author to ask for permission. For software which is copyrighted by the Free Software Foundation, write to the Free Software Foundation; we sometimes make exceptions for this. Our decision will be guided by the two goals of preserving the free status of all derivatives of our free software and of promoting the sharing and reuse of software generally.

NO WARRANTY

11. BECAUSE THE PROGRAM IS LICENSED FREE OF CHARGE, THERE IS NO WARRANTY FOR THE PROGRAM, TO THE EXTENT PERMITTED BY APPLICABLE LAW. EXCEPT WHEN OTHERWISE STATED IN WRITING THE COPYRIGHT HOLDERS AND/OR OTHER PARTIES PROVIDE THE PROGRAM "AS IS" WITHOUT WARRANTY OF ANY KIND, EITHER EXPRESSED OR IMPLIED, INCLUDING, BUT NOT LIMITED TO, THE IMPLIED WARRANTIES OF MERCHANTABILITY AND FITNESS FOR A PARTICULAR PURPOSE. THE ENTIRE RISK AS TO THE QUALITY AND PERFORMANCE OF THE PROGRAM IS WITH YOU. SHOULD THE PROGRAM PROVE DEFECTIVE, YOU ASSUME THE COST OF ALL NECESSARY SERVICING, REPAIR OR CORRECTION.
12. IN NO EVENT UNLESS REQUIRED BY APPLICABLE LAW OR AGREED TO IN WRITING WILL ANY COPYRIGHT HOLDER, OR ANY OTHER PARTY WHO MAY MODIFY AND/OR REDISTRIBUTE THE PROGRAM AS PERMITTED ABOVE, BE LIABLE TO YOU FOR DAMAGES, INCLUDING ANY GENERAL, SPECIAL, INCIDENTAL OR CONSEQUENTIAL DAMAGES ARISING OUT OF THE USE OR INABILITY TO USE THE PROGRAM (INCLUDING BUT NOT LIMITED TO LOSS OF DATA OR DATA BEING RENDERED INACCURATE OR LOSSES SUSTAINED BY YOU OR THIRD PARTIES OR A FAILURE OF THE PROGRAM TO OPERATE WITH ANY OTHER PROGRAMS), EVEN IF SUCH HOLDER OR OTHER PARTY HAS BEEN ADVISED OF THE POSSIBILITY OF SUCH DAMAGES.

END OF TERMS AND CONDITIONS

How to Apply These Terms to Your New Programs

If you develop a new program, and you want it to be of the greatest possible use to the public, the best way to achieve this is to make it free software which everyone can redistribute and change under these terms.

To do so, attach the following notices to the program. It is safest to attach them to the start of each source file to most effectively convey the exclusion of warranty; and each file should have at least the "copyright" line and a pointer to where the full notice is found.

```
<one line to give the program's name and a brief idea of what it does.>
```

```
Copyright © <year> <name of author>
```

This program is free software; you can redistribute it and/or modify it under the terms of the GNU General Public License as published by the Free Software Foundation; either version 2 of the License, or (at your option) any later version.

This program is distributed in the hope that it will be useful, but WITHOUT ANY WARRANTY; without even the implied warranty of MERCHANTABILITY or FITNESS FOR A PARTICULAR PURPOSE. See the GNU General Public License for more details.

You should have received a copy of the GNU General Public License along with this program; if not, write to the Free Software Foundation, Inc., 51 Franklin Street, Fifth Floor, Boston, MA 02110-1301 USA.

Also add information on how to contact you by electronic and paper mail.

If the program is interactive, make it output a short notice like this when it starts in an interactive mode:

```
Gnomovision version 69, Copyright © year name of author
Gnomovision comes with ABSOLUTELY NO WARRANTY; for details
type 'show w'. This is free software, and you are welcome to
redistribute it under certain conditions; type 'show c' for details.
```

The hypothetical commands 'show w' and 'show c' should show the appropriate parts of the General Public License. Of course, the commands you use may be called something other than 'show w' and 'show c'; they could even be mouse-clicks or menu items—whatever suits your program.

You should also get your employer (if you work as a programmer) or your school, if any, to sign a "copyright disclaimer" for the program, if necessary. Here is a sample; alter the names:

```
Yoyodyne, Inc., hereby disclaims all copyright interest in the program
'Gnomovision' (which makes passes at compilers) written by James
Hacker.
```

```
<signature of Ty Coon>, 1 April 1989
Ty Coon, President of Vice
```

This General Public License does not permit incorporating your program into proprietary programs. If your program is a subroutine library, you may consider it more useful to permit linking proprietary applications with the library. If this is what you want to do, use the GNU Lesser General Public License instead of this License.

GNU LESSER GENERAL PUBLIC LICENSE

Version 2.1, February 1999

Copyright © 1991, 1999 Free Software Foundation, Inc., 51 Franklin Street, Fifth Floor, Boston, MA 02110-1301 USA
Everyone is permitted to copy and distribute verbatim copies of this license document, but changing it is not allowed.

[This is the first released version of the Lesser GPL.

It also counts as the successor of the GNU Library Public License, version 2, hence the version number 2.1.]

Preamble

The licenses for most software are designed to take away your freedom to share and change it. By contrast, the GNU General Public Licenses are intended to guarantee your freedom to share and change free software—to make sure the software is free for all its users.

This license, the Lesser General Public License, applies to some specially designated software packages—typically libraries—of the Free Software Foundation and other authors who decide to use it. You can use it too, but we suggest you first think carefully about whether this license or the ordinary General Public License is the better strategy to use in any particular case, based on the explanations below.

When we speak of free software, we are referring to freedom of use, not price. Our General Public Licenses are designed to make sure that you have the freedom to distribute copies of free software (and charge for this service if you wish); that you receive source code or can get it if you want it; that you can change the software and use pieces of it in new free programs; and that you are informed that you can do these things.

To protect your rights, we need to make restrictions that forbid distributors to deny you these rights or to ask you to surrender these rights. These restrictions translate to certain responsibilities for you if you distribute copies of the library or if you modify it.

For example, if you distribute copies of the library, whether gratis or for a fee, you must give the recipients all the rights that we gave you. You must make sure that they, too, receive or can get the source code. If you link other code with the library, you must provide complete object files to the recipients, so that they can relink them with the library after making changes to the library and recompiling it. And you must show them these terms so they know their rights.

We protect your rights with a two-step method: (1) we copyright the library, and (2) we offer you this license, which gives you legal permission to copy, distribute and/or modify the library.

To protect each distributor, we want to make it very clear that there is no warranty for the free library. Also, if the library is modified by someone else and passed on, the recipients should know that what they have is not the original version, so that the original author's reputation will not be affected by problems that might be introduced by others.

Finally, software patents pose a constant threat to the existence of any free program. We wish to make sure that a company cannot effectively restrict the users of a free program by obtaining a restrictive license from a patent holder. Therefore, we insist that any patent license obtained for a version of the library must be consistent with the full freedom of use specified in this license.

Most GNU software, including some libraries, is covered by the ordinary GNU General Public License. This license, the GNU Lesser General Public License, applies to certain designated libraries, and is quite different from the ordinary General Public License. We use this license for certain libraries in order to permit linking those libraries into non-free programs.

When a program is linked with a library, whether statically or using a shared library, the combination of the two is legally speaking a combined work, a derivative of the original library. The ordinary General Public License therefore permits such linking only if the entire combination fits its criteria of freedom. The Lesser General Public License permits more lax criteria for linking other code with the library.

We call this license the “Lesser” General Public License because it does Less to protect the user's freedom than the ordinary General Public License. It also provides other free software developers Less of an advantage over competing non-free programs. These disadvantages are the reason we use the ordinary General Public License for many libraries. However, the Lesser license provides advantages in certain special circumstances.

For example, on rare occasions, there may be a special need to encourage the widest possible use of a certain library, so that it becomes a de-facto standard. To achieve this, non-free programs must be allowed to use the library. A more frequent case is that a free library does the same job as widely used non-free libraries. In this case, there is little to gain by limiting the free library to free software only, so we use the Lesser General Public License.

In other cases, permission to use a particular library in non-free programs enables a greater number of people to use a large body of free software. For example, permission to use the GNU C Library in non-free programs

enables many more people to use the whole GNU operating system, as well as its variant, the GNU/Linux operating system.

Although the Lesser General Public License is Less protective of the users' freedom, it does ensure that the user of a program that is linked with the Library has the freedom and the wherewithal to run that program using a modified version of the Library.

The precise terms and conditions for copying, distribution and modification follow. Pay close attention to the difference between a “work based on the library” and a “work that uses the library”. The former contains code derived from the library, whereas the latter must be combined with the library in order to run.

GNU LESSER GENERAL PUBLIC LICENSE TERMS AND CONDITIONS FOR COPYING, DISTRIBUTION AND MODIFICATION

0. This License Agreement applies to any software library or other program which contains a notice placed by the copyright holder or other authorized party saying it may be distributed under the terms of this Lesser General Public License (also called “this License”). Each licensee is addressed as “you”.

A “library” means a collection of software functions and/or data prepared so as to be conveniently linked with application programs (which use some of those functions and data) to form executables.

The “Library”, below, refers to any such software library or work which has been distributed under these terms. A “work based on the Library” means either the Library or any derivative work under copyright law: that is to say, a work containing the Library or a portion of it, either verbatim or with modifications and/or translated straightforwardly into another language. (Hereinafter, translation is included without limitation in the term “modification”).

“Source code” for a work means the preferred form of the work for making modifications to it. For a library, complete source code means all the source code for all modules it contains, plus any associated interface definition files, plus the scripts used to control compilation and installation of the library.

Activities other than copying, distribution and modification are not covered by this License; they are outside its scope. The act of running a program using the Library is not restricted, and output from such a program is covered only if its contents constitute a work based on the Library (independent of the use of the Library in a tool for writing it). Whether that is true depends on what the Library does and what the program that uses the Library does.

1. You may copy and distribute verbatim copies of the Library's complete source code as you receive it, in any medium, provided that you conspicuously and appropriately publish on each copy an appropriate copyright notice and disclaimer of warranty; keep intact all the notices that refer to this License and to the absence of any warranty; and distribute a copy of this License along with the Library.

You may charge a fee for the physical act of transferring a copy, and you may at your option offer warranty protection in exchange for a fee.

2. You may modify your copy or copies of the Library or any portion of it, thus forming a work based on the Library, and copy and distribute such modifications or work under the terms of Section 1 above, provided that you also meet all of these conditions:

- The modified work must itself be a software library.
- You must cause the files modified to carry prominent notices stating that you changed the files and the date of any change.
- You must cause the whole of the work to be licensed at no charge to all third parties under the terms of this License.
- If a facility in the modified Library refers to a function or a table of data to be supplied by an application program that uses the facility, other than as an argument passed when the facility is invoked, then you must make a good faith effort to ensure that, in the event an application does not supply such function or table,

the facility still operates, and performs whatever part of its purpose remains meaningful.

(For example, a function in a library to compute square roots has a purpose that is entirely well-defined independent of the application. Therefore, Subsection 2d requires that any application-supplied function or table used by this function must be optional: if the application does not supply it, the square root function must still compute square roots.)

These requirements apply to the modified work as a whole. If identifiable sections of that work are not derived from the Library, and can be reasonably considered independent and separate works in themselves, then this License, and its terms, do not apply to those sections when you distribute them as separate works. But when you distribute the same sections as part of a whole which is a work based on the Library, the distribution of the whole must be on the terms of this License, whose permissions for other licensees extend to the entire whole, and thus to each and every part regardless of who wrote it.

Thus, it is not the intent of this section to claim rights or contest your rights to work written entirely by you; rather, the intent is to exercise the right to control the distribution of derivative or collective works based on the Library.

In addition, mere aggregation of another work not based on the Library with the Library (or with a work based on the Library) on a volume of a storage or distribution medium does not bring the other work under the scope of this License.

3. You may opt to apply the terms of the ordinary GNU General Public License instead of this License to a given copy of the Library. To do this, you must alter all the notices that refer to this License, so that they refer to the ordinary GNU General Public License, version 2, instead of to this License. (If a newer version than version 2 of the ordinary GNU General Public License has appeared, then you can specify that version instead if you wish.) Do not make any other change in these notices.

Once this change is made in a given copy, it is irreversible for that copy, so the ordinary GNU General Public License applies to all subsequent copies and derivative works made from that copy.

This option is useful when you wish to copy part of the code of the Library into a program that is not a library.

4. You may copy and distribute the Library (or a portion or derivative of it, under Section 2) in object code or executable form under the terms of Sections 1 and 2 above provided that you accompany it with the complete corresponding machine-readable source code, which must be distributed under the terms of Sections 1 and 2 above on a medium customarily used for software interchange.

If distribution of object code is made by offering access to copy from a designated place, then offering equivalent access to copy the source code from the same place satisfies the requirement to distribute the source code, even though third parties are not compelled to copy the source along with the object code.

5. A program that contains no derivative of any portion of the Library, but is designed to work with the Library by being compiled or linked with it, is called a "work that uses the Library". Such a work, in isolation, is not a derivative work of the Library, and therefore falls outside the scope of this License.

However, linking a "work that uses the Library" with the Library creates an executable that is a derivative of the Library (because it contains portions of the Library), rather than a "work that uses the library". The executable is therefore covered by this License. Section 6 states terms for distribution of such executables.

When a "work that uses the Library" uses material from a header file that is part of the Library, the object code for the work may be a derivative work of the Library even though the source code is not. Whether this is true is especially significant if the work can be linked without the Library, or if the work is itself a library. The threshold for this to be true is not precisely defined by law.

If such an object file uses only numerical parameters, data structure layouts and accessors, and small macros and small inline functions (ten lines or less in length), then the use of the object file is unrestricted, regardless of whether it is legally a derivative work. (Executables containing this object code plus portions of the Library will still fall under Section 6.)

Otherwise, if the work is a derivative of the Library, you may distribute the object code for the work under the terms of Section 6. Any executables containing that work also fall under Section 6, whether or not they are linked directly with the Library itself.

6. As an exception to the Sections above, you may also combine or link a "work that uses the Library" with the Library to produce a work containing portions of the Library, and distribute that work under terms of your choice, provided that the terms permit modification of the work for the customer's own use and reverse engineering for debugging such modifications.

You must give prominent notice with each copy of the work that the Library is used in it and that the Library and its use are covered by this License. You must supply a copy of this License. If the work during execution displays copyright notices, you must include the copyright notice for the Library among them, as well as a reference directing the user to the copy of this License. Also, you must do one of these things:

- a) Accompany the work with the complete corresponding machine-readable source code for the Library including whatever changes were used in the work (which must be distributed under Sections 1 and 2 above); and, if the work is an executable linked with the Library, with the complete machine-readable "work that uses the Library", as object code and/or source code, so that the user can modify the Library and then relink to produce a modified executable containing the modified Library. (It is understood that the user who changes the contents of definitions files in the Library will not necessarily be able to recompile the application to use the modified definitions.)
- b) Use a suitable shared library mechanism for linking with the Library. A suitable mechanism is one that (1) uses at run time a copy of the library already present on the user's computer system, rather than copying library functions into the executable, and (2) will operate properly with a modified version of the library, if the user installs one, as long as the modified version is interface-compatible with the version that the work was made with.
- c) Accompany the work with a written offer, valid for at least three years, to give the same user the materials specified in Subsection 6a, above, for a charge no more than the cost of performing this distribution.
- d) If distribution of the work is made by offering access to copy from a designated place, offer equivalent access to copy the above specified materials from the same place.
- e) Verify that the user has already received a copy of these materials or that you have already sent this user a copy.

For an executable, the required form of the "work that uses the Library" must include any data and utility programs needed for reproducing the executable from it. However, as a special exception, the materials to be distributed need not include anything that is normally distributed (in either source or binary form) with the major components (compiler, kernel, and so on) of the operating system on which the executable runs, unless that component itself accompanies the executable.

It may happen that this requirement contradicts the license restrictions of other proprietary libraries that do not normally accompany the operating system. Such a contradiction means you cannot use both them and the Library together in an executable that you distribute.

7. You may place library facilities that are a work based on the Library side-by-side in a single library together with other library facilities not covered by this License, and distribute such a combined library, provided that the separate distribution of the work based on the Library and of the other library facilities is otherwise permitted, and provided that you do these two things:
 - a) Accompany the combined library with a copy of the same work based on the Library, uncombined with any other library facilities. This must be distributed under the terms of the Sections above.
 - b) Give prominent notice with the combined library of the fact that part of it is a work based on the Library, and explaining where to find the accompanying uncombined form of the same work.
8. You may not copy, modify, sublicense, link with, or distribute the Library except as expressly provided under this License. Any attempt otherwise to copy, modify, sublicense, link with, or distribute the Library is void, and will automatically terminate your rights under this License. However, parties who have received copies, or rights, from you under this License will not have their licenses terminated so long as such parties remain in full compliance.
9. You are not required to accept this License, since you have not signed it. However, nothing else grants you permission to modify or distribute the Library or its derivative works. These actions are prohibited by law if you do not accept this License. Therefore, by modifying or distributing the Library (or any work based on the Library), you indicate your acceptance of this License to do so, and all its terms and conditions for copying, distributing or modifying the Library or works based on it.
10. Each time you redistribute the Library (or any work based on the Library), the recipient automatically receives a license from the original licensor to copy, distribute, link with or modify the Library subject to these terms and conditions. You may not impose any further restrictions on the recipients' exercise of the rights granted herein. You are not responsible for enforcing compliance by third parties with this License.

11. If, as a consequence of a court judgment or allegation of patent infringement or for any other reason (not limited to patent issues), conditions are imposed on you (whether by court order, agreement or otherwise) that contradict the conditions of this License, they do not excuse you from the conditions of this License. If you cannot distribute so as to satisfy simultaneously your obligations under this License and any other pertinent obligations, then as a consequence you may not distribute the Library at all. For example, if a patent license would not permit royalty-free redistribution of the Library by all those who receive copies directly or indirectly through you, then the only way you could satisfy both it and this License would be to refrain entirely from distribution of the Library.

If any portion of this section is held invalid or unenforceable under any particular circumstance, the balance of the section is intended to apply, and the section as a whole is intended to apply in other circumstances.

It is not the purpose of this section to induce you to infringe any patents or other property right claims or to contest validity of any such claims; this section has the sole purpose of protecting the integrity of the free software distribution system which is implemented by public license practices. Many people have made generous contributions to the wide range of software distributed through that system in reliance on consistent application of that system; it is up to the author/donor to decide if he or she is willing to distribute software through any other system and a licensee cannot impose that choice.

This section is intended to make thoroughly clear what is believed to be a consequence of the rest of this License.

12. If the distribution and/or use of the Library is restricted in certain countries either by patents or by copyrighted interfaces, the original copyright holder who places the Library under this License may add an explicit geographical distribution limitation excluding those countries, so that distribution is permitted only in or among countries not thus excluded. In such case, this License incorporates the limitation as if written in the body of this License.

13. The Free Software Foundation may publish revised and/or new versions of the Lesser General Public License from time to time. Such new versions will be similar in spirit to the present version, but may differ in detail to address new problems or concerns.

Each version is given a distinguishing version number. If the Library specifies a version number of this License which applies to it and "any later version", you have the option of following the terms and conditions either of that version or of any later version published by the Free Software Foundation. If the Library does not specify a license version number, you may choose any version ever published by the Free Software Foundation.

14. If you wish to incorporate parts of the Library into other free programs whose distribution conditions are incompatible with these, write to the author to ask for permission. For software which is copyrighted by the Free Software Foundation, write to the Free Software Foundation; we sometimes make exceptions for this. Our decision will be guided by the two goals of preserving the free status of all derivatives of our free software and of promoting the sharing and reuse of software generally.

NO WARRANTY

15. BECAUSE THE LIBRARY IS LICENSED FREE OF CHARGE, THERE IS NO WARRANTY FOR THE LIBRARY, TO THE EXTENT PERMITTED BY APPLICABLE LAW. EXCEPT WHEN OTHERWISE STATED IN WRITING THE COPYRIGHT HOLDERS AND/OR OTHER PARTIES PROVIDE THE LIBRARY "AS IS" WITHOUT WARRANTY OF ANY KIND, EITHER EXPRESSED OR IMPLIED, INCLUDING, BUT NOT LIMITED TO, THE IMPLIED WARRANTIES OF MERCHANTABILITY AND FITNESS FOR A PARTICULAR PURPOSE. THE ENTIRE RISK AS TO THE QUALITY AND PERFORMANCE OF THE LIBRARY IS WITH YOU. SHOULD THE LIBRARY PROVE DEFECTIVE, YOU ASSUME THE COST OF ALL NECESSARY SERVICING, REPAIR OR CORRECTION.

16. IN NO EVENT UNLESS REQUIRED BY APPLICABLE LAW OR AGREED TO IN WRITING WILL ANY COPYRIGHT HOLDER, OR ANY OTHER PARTY WHO MAY MODIFY AND/OR REDISTRIBUTE THE LIBRARY AS PERMITTED ABOVE, BE LIABLE TO YOU FOR DAMAGES, INCLUDING ANY GENERAL, SPECIAL, INCIDENTAL OR CONSEQUENTIAL DAMAGES ARISING OUT OF THE USE OR INABILITY TO USE THE LIBRARY (INCLUDING BUT NOT LIMITED TO LOSS OF DATA OR DATA BEING RENDERED INACCURATE OR LOSSES SUSTAINED BY YOU OR THIRD PARTIES OR A FAILURE OF THE LIBRARY TO OPERATE WITH ANY OTHER SOFTWARE), EVEN IF SUCH HOLDER OR OTHER PARTY HAS BEEN ADVISED OF THE POSSIBILITY OF SUCH DAMAGES.

END OF TERMS AND CONDITIONS

How to Apply These Terms to Your New Libraries

If you develop a new library, and you want it to be of the greatest possible use to the public, we recommend making it free software that everyone can redistribute and change. You can do so by permitting redistribution under these terms (or, alternatively, under the terms of the ordinary General Public License).

To apply these terms, attach the following notices to the library. It is safest to attach them to the start of each source file to most effectively convey the exclusion of warranty; and each file should have at least the "copyright" line and a pointer to where the full notice is found.

<one line to give the library's name and a brief idea of what it does.>
Copyright © <year> <name of author>

This library is free software; you can redistribute it and/or modify it under the terms of the GNU Lesser General Public License as published by the Free Software Foundation; either version 2.1 of the License, or (at your option) any later version.

This library is distributed in the hope that it will be useful, but WITHOUT ANY WARRANTY; without even the implied warranty of MERCHANTABILITY or FITNESS FOR A PARTICULAR PURPOSE. See the GNU Lesser General Public License for more details.

You should have received a copy of the GNU Lesser General Public License along with this library; if not, write to the Free Software Foundation, Inc., 51 Franklin Street, Fifth Floor, Boston, MA 02110-1301 USA

Also add information on how to contact you by electronic and paper mail.

You should also get your employer (if you work as a programmer) or your school, if any, to sign a "copyright disclaimer" for the library, if necessary. Here is a sample; alter the names:

Yoyodyne, Inc., hereby disclaims all copyright interest in the library 'Frob' (a library for tweaking knobs) written by James Random Hacker.

<signature of Ty Coon>, 1 April 1990
Ty Coon, President of Vice

That's all there is to it!

libpng

This copy of the libpng notices is provided for your convenience. In case of any discrepancy between this copy and the notices in the file png.h that is included in the libpng distribution, the latter shall prevail.

COPYRIGHT NOTICE, DISCLAIMER, and LICENSE:

If you modify libpng you may insert additional notices immediately following this sentence.

This code is released under the libpng license.

libpng versions 1.0.7, July 1, 2000, through 1.6.18, July 23, 2015, are Copyright © 2000-2002, 2004, 2006-2015 Glenn Randers-Pehrson, and are distributed according to the same disclaimer and license as libpng-1.0.6 with the following individuals added to the list of Contributing Authors:

Simon-Pierre Cadieux
Eric S. Raymond
Mans Rullgard
Cosmin Truta
Gilles Vollant
James Yu

and with the following additions to the disclaimer:

There is no warranty against interference with your enjoyment of the library or against infringement. There is no warranty that our efforts or the library will fulfill any of your particular purposes or needs. This library is provided with all faults, and the entire risk of satisfactory quality, performance, accuracy, and effort is with the user.

libpng versions 0.97, January 1998, through 1.0.6, March 20, 2000, are Copyright © 1998-2000 Glenn Randers-Pehrson, and are distributed according to the same disclaimer and license as libpng-0.96, with the following individuals added to the list of Contributing Authors:

Tom Lane
Glenn Randers-Pehrson
Willem van Schaik

libpng versions 0.89, June 1996, through 0.96, May 1997, are Copyright © 1996-1997 Andreas Dilger, and are distributed according to the same disclaimer and license as libpng-0.88, with the following individuals added to the list of Contributing Authors:

John Bowler
Kevin Bracey

Sam Bushell
Magnus Holmgren
Greg Roelofs
Tom Tanner

libpng versions 0.5, May 1995, through 0.88, January 1996, are Copyright © 1995-1996 Guy Eric Schalnat, Group 42, Inc.

For the purposes of this copyright and license, "Contributing Authors" is defined as the following set of individuals:

Andreas Dilger
Dave Martindale
Guy Eric Schalnat
Paul Schmidt
Tim Wegner

The PNG Reference Library is supplied "AS IS". The Contributing Authors and Group 42, Inc. disclaim all warranties, expressed or implied, including, without limitation, the warranties of merchantability and of fitness for any purpose. The Contributing Authors and Group 42, Inc. assume no liability for direct, indirect, incidental, special, exemplary, or consequential damages, which may result from the use of the PNG Reference Library, even if advised of the possibility of such damage.

Permission is hereby granted to use, copy, modify, and distribute this source code, or portions hereof, for any purpose, without fee, subject to the following restrictions:

1. The origin of this source code must not be misrepresented.
2. Altered versions must be plainly marked as such and must not be misrepresented as being the original source.
3. This Copyright notice may not be removed or altered from any source or altered source distribution.

The Contributing Authors and Group 42, Inc. specifically permit, without fee, and encourage the use of this source code as a component to supporting the PNG file format in commercial products. If you use this source code in a product, acknowledgment is not required but would be appreciated.

A "png_get_copyright" function is available, for convenient use in "about" boxes and the like:

```
printf("%s", png_get_copyright(NULL));
```

Also, the PNG logo (in PNG format, of course) is supplied in the files "pngbar.png" and "pngbar.jpg" (88x31) and "pngnow.png" (98x31).

libpng is OSI Certified Open Source Software. OSI Certified Open Source is a certification mark of the Open Source Initiative. OSI has not addressed the additional disclaimers inserted at version 1.0.7.

Glenn Randers-Pehrson
glennrp at users.sourceforge.net
July 23, 2015

libuuid

Copyright: 1996, 1997, 1998, 1999, 2007 Theodore Ts'o.
1999 Andreas Dilger (adilger@enel.ucalgary.ca)

Redistribution and use in source and binary forms, with or without modification, are permitted provided that the following conditions are met:

1. Redistributions of source code must retain the above copyright notice, and the entire permission notice in its entirety, including the disclaimer of warranties.
2. Redistributions in binary form must reproduce the above copyright notice, this list of conditions and the following disclaimer in the documentation and/or other materials provided with the distribution.
3. The name of the author may not be used to endorse or promote products derived from this software without specific prior written permission.

THIS SOFTWARE IS PROVIDED "AS IS" AND ANY EXPRESS OR IMPLIED WARRANTIES, INCLUDING, BUT NOT LIMITED TO, THE IMPLIED WARRANTIES OF MERCHANTABILITY AND FITNESS FOR A PARTICULAR PURPOSE, ALL OF WHICH ARE HEREBY DISCLAIMED. IN NO EVENT SHALL THE AUTHOR BE LIABLE FOR ANY DIRECT, INDIRECT, INCIDENTAL, SPECIAL, EXEMPLARY, OR CONSEQUENTIAL DAMAGES (INCLUDING, BUT NOT LIMITED TO, PROCUREMENT OF SUBSTITUTE GOODS OR SERVICES; LOSS OF USE, DATA, OR PROFITS; OR BUSINESS INTERRUPTION) HOWEVER CAUSED AND ON ANY THEORY OF LIABILITY, WHETHER IN CONTRACT, STRICT LIABILITY, OR TORT (INCLUDING NEGLIGENCE OR OTHERWISE) ARISING IN ANY WAY OUT OF THE USE OF THIS SOFTWARE, EVEN IF ADVISED OF THE POSSIBILITY OF SUCH DAMAGE.

- Qt

```
/*  
**  
** Copyright (C) 2013 Digia Plc and/or its subsidiary(-ies).  
** Contact: http://www.qt-project.org/legal  
**  
** This file is part of the examples of the Qt Toolkit.  
**  
** $QT_BEGIN_LICENSE:BSD$  
** You may use this file under the terms of the BSD license as follows:  
**  
** Redistribution and use in source and binary forms, with or without  
** modification, are permitted provided that the following conditions are  
** met:  
** * Redistributions of source code must retain the above copyright  
** notice, this list of conditions and the following disclaimer.  
** * Redistributions in binary form must reproduce the above copyright  
** notice, this list of conditions and the following disclaimer in  
** the documentation and/or other materials provided with the  
** distribution.  
** * Neither the name of Digia Plc and its Subsidiary(-ies) nor the names  
** of its contributors may be used to endorse or promote products  
** derived  
** from this software without specific prior written permission.  
**  
** THIS SOFTWARE IS PROVIDED BY THE COPYRIGHT HOLDERS AND  
** CONTRIBUTORS  
** "AS IS" AND ANY EXPRESS OR IMPLIED WARRANTIES, INCLUDING,  
** BUT NOT  
** LIMITED TO, THE IMPLIED WARRANTIES OF MERCHANTABILITY AND  
** FITNESS FOR  
** A PARTICULAR PURPOSE ARE DISCLAIMED. IN NO EVENT SHALL  
** THE COPYRIGHT  
** OWNER OR CONTRIBUTORS BE LIABLE FOR ANY DIRECT,  
** INDIRECT, INCIDENTAL,  
** SPECIAL, EXEMPLARY, OR CONSEQUENTIAL DAMAGES  
** (INCLUDING, BUT NOT  
** LIMITED TO, PROCUREMENT OF SUBSTITUTE GOODS OR  
** SERVICES; LOSS OF USE,  
** DATA, OR PROFITS; OR BUSINESS INTERRUPTION) HOWEVER  
** CAUSED AND ON ANY  
** THEORY OF LIABILITY, WHETHER IN CONTRACT, STRICT LIABILITY,  
** OR TORT  
** (INCLUDING NEGLIGENCE OR OTHERWISE) ARISING IN ANY WAY  
** OUT OF THE USE  
** OF THIS SOFTWARE, EVEN IF ADVISED OF THE POSSIBILITY OF  
** SUCH DAMAGE."  
** $QT_END_LICENSE$  
**  
***/
```

Note on source code distribution

For three years after the final factory shipment, you may request from Yamaha the source code for any portions of the product which are licensed under the GNU General Public License or GNU Lesser General Public License by writing to the following address:

Synth Marketing Section, ProMusic Department, Musical Instruments
Sales and Marketing Division, YAMAHA Corporation
10-1 Nakazawa-cho, Naka-ku, Hamamatsu, 430-8650, JAPAN

The source code will be provided at no charge; however, we may require you to reimburse Yamaha for the cost of delivering the source code to you.

- Note that we shall bear no responsibility whatsoever for any damage arising from changes (additions/ deletions) made to the software for this product by a third party other than Yamaha (or party authorized by Yamaha).
- Note that re-use of source code released to the public domain by Yamaha is unguaranteed, and Yamaha shall not bear any responsibility whatsoever for the source code.
- The source code can be downloaded from the following address:
<http://download.yamaha.com/sourcecodes/synth/>

Important Notice: Guarantee Information for customers in European Economic Area (EEA) and Switzerland

| | |
|--|-----------------------|
| Important Notice: Guarantee Information for customers in EEA* and Switzerland For detailed guarantee information about this Yamaha product, and Pan-EEA* and Switzerland warranty service, please either visit the website address below (Printable file is available at our website) or contact the Yamaha representative office for your country. * EEA: European Economic Area | English |
| Wichtiger Hinweis: Garantie-Information für Kunden in der EWR* und der Schweiz Für nähere Garantie-Information über dieses Produkt von Yamaha, sowie über den Pan-EWR*- und Schweizer Garantieservice, besuchen Sie bitte entweder die folgend angegebene Internetadresse (eine druckfähige Version befindet sich auch auf unserer Webseite), oder wenden Sie sich an den für Ihr Land zuständigen Yamaha-Vertrieb. *EWR: Europäischer Wirtschaftsraum | Deutsch |
| Remarque importante: informations de garantie pour les clients de l'EEE et la Suisse Pour des informations plus détaillées sur la garantie de ce produit Yamaha et sur le service de garantie applicable dans l'ensemble de l'EEE ainsi qu'en Suisse, consultez notre site Web à l'adresse ci-dessous (le fichier imprimable est disponible sur notre site Web) ou contactez directement Yamaha dans votre pays de résidence. * EEE : Espace Economique Européen | Français |
| Belangrijke mededeling: Garantie-informatie voor klanten in de EER* en Zwitserland Voor gedetailleerde garantie-informatie over dit Yamaha-product en de garantieservice in heel de EER* en Zwitserland, gaat u naar de onderstaande website (u vindt een afdrukbaar bestand op onze website) of neemt u contact op met de vertegenwoordiging van Yamaha in uw land. * EER: Europese Economische Ruimte | Nederlands |
| Aviso importante: información sobre la garantía para los clientes del EEE* y Suiza Para una información detallada sobre este producto Yamaha y sobre el soporte de garantía en la zona EEE* y Suiza, visite la dirección web que se incluye más abajo (la versión del archivo para imprimir esta disponible en nuestro sitio web) o póngase en contacto con el representante de Yamaha en su país. * EEE: Espacio Económico Europeo | Español |
| Avviso importante: informazioni sulla garanzia per i clienti residenti nell'EEA* e in Svizzera Per informazioni dettagliate sulla garanzia relativa a questo prodotto Yamaha e l'assistenza in garanzia nei paesi EEA* e in Svizzera, potete consultare il sito Web all'indirizzo riportato di seguito (è disponibile il file in formato stampabile) oppure contattare l'ufficio di rappresentanza locale della Yamaha. * EEA: Area Economica Europea | Italiano |
| Aviso importante: informações sobre as garantias para clientes da AEE* e da Suíça Para obter uma informação pormenorizada sobre este produto da Yamaha e sobre o serviço de garantia na AEE* e na Suíça, visite o site a seguir (o arquivo para impressão está disponível no nosso site) ou entre em contato com o escritório de representação da Yamaha no seu país. * AEE: Área Económica Européia | Português |
| Σημαντική σημείωση: Πληροφορίες εγγύησης για τους πελάτες στον ΕΟΧ* και Ελλάδα Για λεπτομερείς πληροφορίες εγγύησης σχετικά με το παρόν προϊόν της Yamaha και την κάλυψη εγγύησης σε όλες τις χώρες του ΕΟΧ και την Ελλάδα, επισκεφτείτε την παρακάτω ιστοσελίδα (Εκτυπώσιμη μορφή είναι διαθέσιμη στην ιστοσελίδα μας) ή απευθυνθείτε στην αντιπροσωπεία της Yamaha στη χώρα σας. * ΕΟΧ: Ευρωπαϊκός Οικονομικός Χώρος | Ελληνικά |
| Viktigt: Garantiinformation för kunder i EES-området* och Schweiz För detaljerad information om denna Yamahaprodukt samt garantiservice i hela EES-området* och Schweiz kan du antingen besöka nedanstående webbadress (en utskriftsvänlig fil finns på webbplatsen) eller kontakta Yamahas officiella representant i ditt land. * EES: Europeiska Ekonomiska Samarbetsområdet | Svenska |
| Viktig merknad: Garantiinformasjon for kunder i EØS* og Sveits Detaljert garantiinformasjon om dette Yamaha-produktet og garantiservice for hele EØS-området* og Sveits kan fås enten ved å besøke nettstedene nedenfor (utskriftsversjon finnes på våre nettsider) eller kontakte Yamahas kontoret i landet der du bor. *EØS: Det europeiske økonomiske samarbeidsområdet | Norsk |
| Vigtig oplysning: Garantioplysninger til kunder i EØ* og Schweiz De kan finde detaljerede garantioplysninger om dette Yamaha-produkt og den fælles garantiserviceordning for EØ* (og Schweiz) ved at besøge det websted, der er angivet nedenfor (der findes en fil, som kan udskrives, på vores websted), eller ved at kontakte Yamahas nationale repræsentationskontor i det land, hvor De bor. * EØ: Det Europæiske Økonomiske Område | Dansk |
| Tärkeä ilmoitus: Takuutiedot Euroopan talousalueen (ETA)* ja Sveitsin asiakkaille Tämän Yamaha-tuotteen sekä ETA-alueen ja Sveitsin takuuta koskevat yksityiskohtaiset tiedot saatte alla olevasta nettiosoitteesta. (Tulostettava tiedosto saatavissa sivustollamme.) Voitte myös ottaa yhteyttä paikalliseen Yamaha-edustajaan. *ETA: Euroopan talousalue | Suomi |
| Ważne: Warunki gwarancyjne obowiązujące w EOG* i Szwajcarii Aby dowiedzieć się więcej na temat warunków gwarancyjnych tego produktu firmy Yamaha i serwisu gwarancyjnego w całym EOG* i Szwajcarii, należy odwiedzić wskazaną poniżej stronę internetową (Plik gotowy do wydruku znajduje się na naszej stronie internetowej) lub skontaktować się z przedstawicielstwem firmy Yamaha w swoim kraju. * EOG — Europejski Obszar Gospodarczy | Polski |
| Důležité oznámení: Záruční informace pro zákazníky v EHS* a ve Švýcarsku Podrobné záruční informace o tomto produktu Yamaha a záručním servisu v celém EHS* a ve Švýcarsku naleznete na níže uvedené webové adrese (soubor k tisku je dostupný na našich webových stránkách) nebo se můžete obrátit na zastoupení firmy Yamaha ve své zemi. * EHS: Evropský hospodářský prostor | Česky |
| Fontos figyelmeztetés: Garancia-információk az EGT* területén és Svájcban élő vásárlók számára A jelen Yamaha termékre vonatkozó részletes garancia-információk, valamint az EGT*-re és Svájcra kiterjedő garanciális szolgáltatás tekintetében keresse fel webhelyünket az alábbi címen (a webhelyen nyomtatható fájl is található), vagy pedig lépjen kapcsolatba az országában működő Yamaha képviselői irodával. * EGT: Európai Gazdasági Térség | Magyar |
| Oluline märkus: Garantiiteave Euroopa Majanduspiirkonna (EMP)* ja Šveitsi klientidele Täpsemate teabe saamiseks selle Yamaha toote garantii ning kogu Euroopa Majanduspiirkonna ja Šveitsi garantiiteeninduse kohta, külastage palun veebisaiti alljärgneval aadressil (meie saidil on saadaval prinditav fail) või pöörduge Teie regiooni Yamaha esinduse poole. * EMP: Euroopa Majanduspiirkond | Eesti keel |
| Svarīgs paziņojums: garantijas informācija klientiem EEZ* un Šveicē Lai saņemtu detalizētu garantijas informāciju par šo Yamaha produktu, kā arī garantijas apkalpošanu EEZ* un Šveicē, lūdzu, apmeklējiet zemāk norādīto tīmekļa vietnes adresi (tīmekļa vietnē ir pieejams drukājams fails) vai sazinieties ar jūsu valsti apkalpojošo Yamaha pārstāvniecību. * EEZ: Eiropas Ekonomikas zona | Latviešu |
| Dėmesio: informacija dėl garantijos pirkėjams EEE* ir Šveicarijoje Jei reikia išsamios informacijos apie šį „Yamaha“ produktą ir jo techninę priežiūrą visoje EEE* ir Šveicarijoje, apsilankykite mūsų svetainėje toliau nurodytu adresu (svetainėje yra spausdintinas failas) arba kreipkitės į „Yamaha“ atstovybę savo šaliai. *EEE – Europos ekonominė erdvė | Lietuvių kalba |
| Dôležité upozornenie: Informácie o záruke pre zákazníkov v EHP* a Švajčiarsku Podrobné informácie o záruke týkajúce sa tohto produktu od spoločnosti Yamaha a garančnom servise v EHP* a Švajčiarsku nájdete na webovej stránke uvedenej nižšie (na našej webovej stránke je k dispozícii súbor na tlač) alebo sa obráťte na zástupcu spoločnosti Yamaha vo svojej krajine. * EHP: Európsky hospodársky priestor | Slovenčina |
| Pomembno obvestilo: Informacije o garanciji za kupce v EGP* in Švici Za podrobnejše informacije o tem Yamahinem izdelku ter garancijskem servisu v celotnem EGP in Švici, obiščite spletno mesto, ki je navedeno spodaj (natisljiva datoteka je na voljo na našem spletnem mestu), ali se obrnite na Yamahinega predstavnika v svoji državi. * EGP: Evropski gospodarski prostor | Slovenščina |
| Важно съобщение: Информация за гаранцията за клиенти в ЕИП* и Швейцария За подробна информация за гаранцията за този продукт на Yamaha и гаранционното обслужване в паневропейската зона на ЕИП* и Швейцария или посетете посочения по-долу уеб сайт (на нашия уеб сайт има файл за печат), или се свържете с представителния офис на Yamaha във вашата страна. * ЕИП: Европейско икономическо пространство | Български език |
| Notificare importantă: Informații despre garanție pentru clienții din SEE* și Elveția Pentru informații detaliate privind acest produs Yamaha și serviciul de garanție Pan-SEE* și Elveția, vizitați site-ul la adresa de mai jos (fișierul imprimabil este disponibil pe site-ul nostru) sau contactați biroul reprezentanței Yamaha din țara dumneavoastră. * SEE: Spațiul Economic European | Limba română |

<http://europe.yamaha.com/warranty/>

LIMITED WARRANTY ON

Music Production Products

Thank you for selecting a YAMAHA product. YAMAHA products are designed and manufactured to provide a high level of defect-free performance. Yamaha Corporation of America ("YAMAHA") is proud of the experience and craftsmanship that goes into each and every YAMAHA product. YAMAHA sells its products through a network of reputable, specially authorized dealers and is pleased to offer you, the Original Owner, the following Limited Warranty, which applies only to products that have been (1) directly purchased from YAMAHA's authorized dealers in the fifty states of the USA and District of Columbia (the "Warranted Area") and (2) used exclusively in the Warranted Area. YAMAHA suggests that you read the Limited Warranty thoroughly, and invites you to contact your authorized YAMAHA dealer or YAMAHA Customer Service if you have any questions.

**THIS WARRANTY COVERS THE LISTED PRODUCTS
AGAINST DEFECTS IN MATERIALS OR WORKMANSHIP
FOR THE FOLLOWING PERIODS:**

Warranty Term

| Type of Product | Duration of Warranty from Date of Purchase by or for the Original Owner |
|------------------------------|---|
| SYNTHESIZERS | 1 year |
| MOBILE MINI KEYBOARD | 1 year |
| MONITOR SPEAKERS | 1 year |
| AUDIO INTERFACES | 1 year |
| MIDI CONTROLLERS | 1 year |
| WIND MIDI CONTROLLERS | 1 year |
| MUSIC PRODUCTION ACCESSORIES | 1 year |

Coverage: YAMAHA will, at its option, repair or replace the product covered by this warranty if it becomes defective, malfunctions or otherwise fails to conform with this warranty under normal use and service during the term of this warranty, without charge for labor or materials. Repairs may be performed using new or refurbished parts that meet or exceed YAMAHA specifications for new parts. If YAMAHA elects to replace the product, the replacement may be a reconditioned unit. You will be responsible for any installation or removal charges and for any initial shipping charges if the product(s) must be shipped for warranty service. However, YAMAHA will pay the return shipping charges to any destination within the USA if the repairs are covered by the warranty. This warranty does not cover (a) damage, deterioration or malfunction resulting from accident, negligence, misuse, abuse, improper installation or operation or failure to follow instructions according to the Owner's Manual for this product; any shipment of the product (claims must be presented to the carrier); repair or attempted repair by anyone other than YAMAHA or an authorized YAMAHA Service Center; (b) any unit which has been altered or on which the serial number has been defaced, modified or removed; (c) normal wear, and any periodic maintenance; (d) deterioration due to perspiration, corrosive atmosphere or other external causes such as extremes in temperature or humidity; (e) damages attributable to power line surge or related electrical abnormalities, lightning damage or acts of God; or (f) RFI/EMI (Interference/noise) caused by improper grounding or the improper use of either certified or uncertified equipment, if applicable. Any evidence of alteration, erasing or forgery of

proof-of-purchase documents will cause this warranty to be void. This warranty covers only the Original Owner and is not transferable.

In Order to Obtain Warranty Service: Warranty service will only be provided for defective products within the Warranted Area. Contact your local authorized YAMAHA dealer who will advise you of the procedures to be followed. If this is not successful, contact YAMAHA at the address, telephone number or website shown below. YAMAHA may request that you send the defective product to a local authorized YAMAHA Servicer or authorize return of the defective product to YAMAHA for repair. If you are uncertain as to whether a dealer has been authorized by YAMAHA, please contact YAMAHA's Service Department at the number shown below, or check Yamaha's website at <http://usa.yamaha.com>. Product(s) shipped for service should be packed securely and must be accompanied by a detailed explanation of the problem(s) requiring service, together with the original or a machine reproduction of the bill of sale or other dated, proof-of-purchase document describing the product, as evidence of warranty coverage. Should any product submitted for warranty service be found ineligible therefore, an estimate of repair cost will be furnished and the repair will be accomplished only if requested by you and upon receipt of payment or acceptable arrangement for payment.

Limitation of Implied Warranties and Exclusion of Damages: ANY IMPLIED WARRANTIES, INCLUDING WARRANTIES OF MERCHANTABILITY AND FITNESS FOR A PARTICULAR PURPOSE SHALL BE LIMITED IN DURATION TO THE APPLICABLE PERIOD OF TIME SET FORTH ABOVE. YAMAHA SHALL NOT BE RESPONSIBLE FOR INCIDENTAL OR CONSEQUENTIAL DAMAGES OR FOR DAMAGES BASED UPON INCONVENIENCE, LOSS OF USE, DAMAGE TO ANY OTHER EQUIPMENT OR OTHER ITEMS AT THE SITE OF USE OR INTERRUPTION OF PERFORMANCES OR ANY CONSEQUENCES. YAMAHA'S LIABILITY FOR ANY DEFECTIVE PRODUCT IS LIMITED TO REPAIR OR REPLACEMENT OF THE PRODUCT, AT YAMAHA'S OPTION. SOME STATES DO NOT ALLOW LIMITATIONS ON HOW LONG AN IMPLIED WARRANTY LASTS OR THE EXCLUSION OR LIMITATION OF INCIDENTAL OR CONSEQUENTIAL DAMAGES, SO THE ABOVE LIMITATION OR EXCLUSION MAY NOT APPLY TO YOU. This Warranty gives you specific legal rights, and you may also have other rights which vary from state to state. This is the only express warranty applicable to the product specified herein; Yamaha neither assumes nor authorizes anyone to assume for it any other express warranty.

If you have any questions about service received or if you need assistance in locating an authorized YAMAHA Servicer, please contact:

Customer Service
Yamaha Corporation of America
6600 Orangethorpe Avenue, Buena Park, CA 90620-1373
Telephone: 800-854-1569 usa.yamaha.com



**Do not return any product to the above address without a written
Return Authorization issued by YAMAHA.**

For details of products, please contact your nearest Yamaha representative or the authorized distributor listed below.

Pour plus de détails sur les produits, veuillez-vous adresser à Yamaha ou au distributeur le plus proche de vous figurant dans la liste suivante.

Die Einzelheiten zu Produkten sind bei Ihrer unten aufgeführten Niederlassung und bei Yamaha Vertragshändlern in den jeweiligen Bestimmungsländern erhältlich.

Para detalles sobre productos, contacte su tienda Yamaha más cercana o el distribuidor autorizado que se lista debajo.

NORTH AMERICA

CANADA

Yamaha Canada Music Ltd.
135 Milner Avenue, Toronto, Ontario M1S 3R1,
Canada
Tel: +1-416-298-1311

U.S.A.

Yamaha Corporation of America
6600 Orangethorpe Avenue, Buena Park, CA 90620,
U.S.A.
Tel: +1-714-522-9011

CENTRAL & SOUTH AMERICA

MEXICO

Yamaha de México, S.A. de C.V.
Av. Insurgentes Sur 1647 Piso 9, Col. San José
Insurgentes, Delegación Benito Juárez, México,
D.F., C.P. 03900
Tel: +52-55-5804-0600

BRAZIL

Yamaha Musical do Brasil Ltda.
Rua Fidêncio Ramos, 302 – Cj 52 e 54 – Torre B –
Vila Olímpia – CEP 04551-010 – São Paulo/SP,
Brazil
Tel: +55-11-3704-1377

ARGENTINA

**Yamaha Music Latin America, S.A.,
Sucursal Argentina**
Olga Cossettini 1553, Piso 4 Norte,
Madero Este-C1107CEK,
Buenos Aires, Argentina
Tel: +54-11-4119-7000

VENEZUELA

Yamaha Musical de Venezuela, C.A.
AV. Manzanares, C.C. Manzanares Plaza,
Piso 4, Oficina 0401, Baruta, Caracas, Venezuela
Tel: +58-212-943-1877

PANAMA AND OTHER LATIN

AMERICAN COUNTRIES/ CARIBBEAN COUNTRIES

Yamaha Music Latin America, S.A.
Edif. Torre Banco General, F7, Urb. Marbella,
Calle 47 y Aquilino de la Guardia, Panama,
P.O.Box 0823-05863, Panama, Rep.de Panama
Tel: +507-269-5311

EUROPE

THE UNITED KINGDOM/IRELAND

Yamaha Music Europe GmbH (UK)
Sherbourne Drive, Tilbrook, Milton Keynes,
MK7 8BL, U.K.
Tel: +44-1908-366700

GERMANY

Yamaha Music Europe GmbH
Siemensstrasse 22-34, 25462 Rellingen, Germany
Tel: +49-4101-303-0

SWITZERLAND/LIECHTENSTEIN

**Yamaha Music Europe GmbH, Rellingen,
Branch Switzerland in Zürich**
Seefeldstrasse 94, 8008 Zürich, Switzerland
Tel: +41-44-3878080

AUSTRIA

Yamaha Music Europe GmbH, Branch Austria
Schleiergasse 20, 1100 Wien, Austria
Tel: +43-1-60203900

CZECH REPUBLIC/HUNGARY/ ROMANIA/SLOVAKIA/SLOVENIA

Yamaha Music Europe GmbH, Branch Austria
Schleiergasse 20, 1100 Wien, Austria
Tel: +43-1-60203900

POLAND/LITHUANIA/LATVIA/ ESTONIA

Yamaha Music Europe GmbH
Sp.z o.o. Oddzial w Polsce
ul. Wrotkowa 14, 02-553 Warsaw, Poland
Tel: +48-22-880-08-88

BULGARIA

Dinacord Bulgaria LTD.
Bul. Iskarsko Schose 7 Targowski Zentar Ewropa
1528 Sofia, Bulgaria
Tel: +359-2-978-20-25

MALTA

Olimpus Music Ltd.
Valletta Road, Mosta MST9010, Malta
Tel: +356-2133-2093

NETHERLANDS/BELGIUM/ LUXEMBOURG

Yamaha Music Europe, Branch Benelux
Clarissenhof 5b, 4133 AB Vianen, The Netherlands
Tel: +31-347-358040

FRANCE

Yamaha Music Europe
7 rue Ambroise Croizat, Zone d'activités de Pariest,
77183 Croissy-Beaubourg, France
Tel: +33-1-6461-4000

ITALY

Yamaha Music Europe GmbH, Branch Italy
Viale Italia 88, 20020, Lainate (Milano), Italy
Tel: +39-02-93577-1

SPAIN/PORTUGAL

**Yamaha Music Europe GmbH Ibérica, Sucursal
en España**
Ctra. de la Coruna km. 17,200, 28231
Las Rozas de Madrid, Spain
Tel: +34-91-639-88-88

GREECE

Philippos Nakas S.A. The Music House
19th klm. Leof. Lavriou 190 02 Peania – Attiki,
Greece
Tel: +30-210-6686260

SWEDEN

**Yamaha Music Europe GmbH Germany filial
Scandinavia**
JA Wettergrensgata 1, 400 43 Göteborg, Sweden
Tel: +46-31-89-34-00

DENMARK

**Yamaha Music Denmark,
Filiat of Yamaha Music Europe GmbH, Tyskland**
Generatorvej 8C, ST. TH., 2860 Søborg, Denmark
Tel: +45-44-92-49-00

FINLAND

F-Musiikki Oy
Antaksentie 4
FI-01510 Vantaa, Finland
Tel: +358 (0)96185111

NORWAY

**Yamaha Music Europe GmbH Germany -
Norwegian Branch**
Grini Næringspark 1, 1332 Østerås, Norway
Tel: +47-6716-7800

ICELAND

Hljóðfaerahusid Ehf.
Sidumula 20
IS-108 Reykjavik, Iceland
Tel: +354-525-5050

CROATIA

Euro Unit D.O.O.
Slakovec 73
40305 Nedelisce
Tel: +38540829400

RUSSIA

Yamaha Music (Russia) LLC.
Room 37, entrance 7, bld. 7, Kievskaya street,
Moscow, 121059, Russia
Tel: +7-495-626-5005

OTHER EUROPEAN COUNTRIES

Yamaha Music Europe GmbH
Siemensstrasse 22-34, 25462 Rellingen, Germany
Tel: +49-4101-303-0

AFRICA

Yamaha Music Gulf FZE
JAFZA-16, Office 512, P.O.Box 17328,
Jebel Ali FZE, Dubai, UAE
Tel: +971-4-801-1500

MIDDLE EAST

TURKEY

Yamaha Music Europe GmbH
Merkezi Almanya Türkiye İstanbul Şubesi
Maslak Meydan Sodak, Spring Giz Plaza Bagimsiz
Böl. No:3, Sariyer Istanbul, Turkey
Tel: +90-212-999-8010

CYPRUS

Nakas Music Cyprus Ltd.
Nikis Ave 2k
1086 Nicosia
Tel: + 357-22-511080

Major Music Center
21 Ali Riza Ave. Ortakoy
P.O.Box 475 Nicosia, Cyprus
Tel: (392) 227 9213

OTHER COUNTRIES

Yamaha Music Gulf FZE
JAFZA-16, Office 512, P.O.Box 17328,
Jebel Ali FZE, Dubai, UAE
Tel: +971-4-801-1500

ASIA

THE PEOPLE'S REPUBLIC OF CHINA

Yamaha Music & Electronics (China) Co., Ltd.
2F, Yunhedasha, 1818 Xinzha-lu, Jingan-qu,
Shanghai, China
Tel: +86-400-051-7700

HONG KONG

Tom Lee Music Co., Ltd.
11/F., Silvercord Tower 1, 30 Canton Road,
Tsimshatsui, Kowloon, Hong Kong
Tel: +852-2737-7688

INDIA

Yamaha Music India Private Limited
Spazedge Building, Ground Floor, Tower A,
Sector-47, Gurgaon- Sohna Road, Gurgaon-122002,
Haryana, India
Tel: +91-124-485-3300

INDONESIA

PT. Yamaha Musik Indonesia (Distributor)
Yamaha Music Center Bldg, Jalan Jend. Gatot
Subroto Kav. 4, Jakarta 12930, Indonesia
Tel: +62-21-520-2577

KOREA

Yamaha Music Korea Ltd.
8F, Dongsung Bldg. 21, Teheran-ro 87-gil,
Gangnam-gu, Seoul, 135-880, Korea
Tel: +82-2-3467-3300

MALAYSIA

Yamaha Music (Malaysia) Sdn. Bhd.
No.8, Jalan Perbandaran, Kelana Jaya, 47301
Petaling Jaya, Selangor, Malaysia
Tel: +60-3-78030900

SINGAPORE

Yamaha Music (Asia) Private Limited
Block 202 Hougang Street 21, #02-00,
Singapore 530202, Singapore
Tel: +65-6740-9200

TAIWAN

Yamaha Music & Electronics Taiwan Co., Ltd.
2F., No.1, Yuandong Rd. Banqiao Dist.
New Taipei City 22063, Taiwan, R.O.C.
Tel: +886-2-7741-8888

THAILAND

Siam Music Yamaha Co., Ltd.
3, 4, 15, 16th Fl., Siam Motors Building,
891/1 Rama 1 Road, Wangmai,
Pathumwan, Bangkok 10330, Thailand
Tel: +66-2215-2622

VIETNAM

Yamaha Music Vietnam Company Limited
15th Floor, Nam A Bank Tower, 201-203 Cach
Mang Thang Tam St., Ward 4, Dist.3,
Ho Chi Minh City, Vietnam
Tel: +84-8-3818-1122

OTHER ASIAN COUNTRIES

<http://asia.yamaha.com>

OCEANIA

AUSTRALIA

Yamaha Music Australia Pty. Ltd.
Level 1, 99 Queensbridge Street, Southbank,
VIC 3006, Australia
Tel: +61-3-9693-5111

NEW ZEALAND

Music Works LTD
P.O.BOX 6246 Wellesley, Auckland 4680,
New Zealand
Tel: +64-9-634-0099

COUNTRIES AND TRUST TERRITORIES IN PACIFIC OCEAN

<http://asia.yamaha.com>

MEMO



ZR61040

Manual Development Department
© 2016 Yamaha Corporation

Published 05/2016 MWTO-B0
Printed in Japan

ZR61040