



Product specification (design and specification subject to change without notice)

■DISPLAY PANEL

Screen Size (Diagonal)	49-inch (1232.0 mm / 48.5inch)
Panel type / Backlight	IPS / Edge LED
Aspect ratio	16:9
Effective Display Area (W x H)	42.27" / 23.77" (1073.8 mm / 604.0 mm)
Resolution (H x V)	3840 x 2160
Brightness (typ)	500 cd/m ²
Contrast Ratio (typ)	1100:1
Dynamic Contrast Ratio	50000:1
Max. Display Colors	Approx. 1.07 Billion
Response Time (typ)	8.0 ms (G to G)
Viewing Angle (Horizontal / Vertical)	178° / 178° (CR≥10)
Panel Life Time*1 (typ)	Approx. 50000 hours
Panel Surface Treatment	Anti glare type (Haze 28%)

*1 When the panel lifetime is at 50% of the brightness under the condition of 25 degrees Celsius (+/- 2 degrees Celsius).

■CONNECTION TERMINAL

HDMI IN	HDMI Type A Connector x 2 (Compatible with HDCP 2.2)	AUDIO: Linear PCM (Sampling frequency : 48 kHz/44.1 kHz/32 kHz)
Display Port Input	Display Port x 1 (Compatible with HDCP 2.2)	AUDIO: Linear PCM (Sampling frequency : 48 kHz/44.1 kHz/32 kHz)
Display Port Output	Display Port x 1 (Compatible with HDCP 1.4)*	
DVI-D IN	DVI-D 24-pin x 1	Compliance with DVI Revision 1.0 Compatible with HDCP 1.1
PC IN	Mini D-Sub 15-pin (DDC2B) x 1	Y/G : with sync 1.0 V [p-p] (75 Ω) : without sync 0.7 V [p-p] (75 Ω) P _B /C _B /B : without sync 0.7 V [p-p] (75 Ω) P _R /C _R /R : without sync 0.7 V [p-p] (75 Ω) HD/VD : HD/VD TTL (high impedance)
SERIAL IN	D-sub 9-pin x 1, RS-232C Compatible	
IR IN / IR OUT	Stereo Mini Jack (M3) x 1 / x 1	
AUDIO IN	Stereo Mini Jack (M3) x 2	0.5 V [rms]
AUDIO OUT	Stereo Mini Jack (M3) x 1	0.5 V [rms]
LAN	RJ45 x 1 compatible with PLink™ RJ45 10BASE-T/100BASE-TX	
DIGITAL LINK / LAN	RJ45 x 1 compatible with PLink™ 100BASE-TX, compatible with Long reach mode (HDCP 2.2)	
USB	USB Connector (Type A) x 2, DC 5 V/2A, DC 5 V/1A (USB 3.0 is supported)	
SLOT	Intel® SDM specification Corresponding size SDM-S / SDM-L, Supply power 3.3 V / 1.1 A, 12 V / 5.5 A	

■AUDIO

Built in Speaker	20 W [10 W + 10 W]
External Speaker Out	30 W [15 W + 15 W] 10%THD

■ELECTRICAL

Power Requirements	AC 110 - 127 Hz / 60 Hz 220 - 240 V 50 Hz / 60 Hz
Power Consumption	285 W
On Mode Average Power Consumption*	147 W
Power Off Condition	Approx. 0.3 W
Stand-by Condition	Approx. 0.5 W
Apparent power	296 W

*Based on IEC 62087 Ed.2 measurement method

■MECHANICAL

Dimension (W x H x D) including handles	1104 mm x 637 mm x 74 mm (W 43.48" x H 25.08" x D 2.91")
not including handles	1104 mm x 637 mm x 66 mm (W 43.48" x H 25.08" x D 2.58")
Weight	21 kg / 46.3 lbs
Bezel Color	Black
Bezel Width	T/B: 14.2 mm, L/R: 12.9 mm (T/B: 0.56", L/R: 0.51")
Carton Dimensions (W x H x D)	1248 mm x 800 mm x 185 mm (W 49.2" x H 31.5" x D 7.3")
Gross Weight	27 kg / 59.6 lbs
Cabinet Color / Material	Front, Back : Metal Side : Plastic
Pitch for Wall-Hanging	VESA Compliant W 400 x H 400 mm (Installed by: M6 screws / Screw hole depth 11 mm)

■INSTALLATION

Orientation	Landscape / Portrait
Tilting Angle	Landscape : 0 - 45 degrees forward / backward Portrait : 0 - 45 degrees forward / backward

*Please contact your sales representative with regard to the tilt angle before installation.

*When installing the Display vertically, be sure that the Power Indicator comes to the upper side

■ENVIRONMENTAL

Operating Environment	Temperature	: 0°C to 40°C (32°F to 104°F) ¹ : 0°C to 35°C (32°F to 95°F) ²
	Humidity	: 20% to 80% (No condensation)
	Altitude	: 0 to 2800 m (0 to 9186 ft)
Storage Environment	Temperature	: -20°C to 60°C (-4°F to 140°F)
	Humidity	: 20% to 80% (No condensation)

¹ : for up to 1400 m (4593 ft) altitude ² : for between 1400 m (4593 ft) and 2800 m (9186 ft) altitude

• Depending on the temperature or humidity conditions, uneven brightness may be observed. This is not a malfunction.

• This unevenness will disappear while applying current continuously. If not, consult the distributor.

MAIN FEATURE

USB Media Player	Yes (4K is supported)
Failover/Failback	Yes
Data Cloning	Yes
Digital Zoom	Yes
Multi display settings	Yes
Power on Screen Delay	Yes
Auto setting	Yes
Screen Saver	Yes
Power Management	Yes (HDMI/DP/DVI-D/PC/DIGITAL LINK)
Power save	Yes
Button Lock	Yes
Controller user level	Yes
Input search	Yes
6,12-segment colour management	Yes
Dynamic contrast	Yes
Color enhancement	Yes
Refine enhancer	Yes
Gradation smoother	Yes
Dynamic backlight control	Yes
Set up timer	Yes
Content management Software compatible	Yes
Image settings	Yes
HDMI CEC Compatible	Yes
Memory Viewer	Yes
Operating Time*1	24h / day
AMX D.D.	Yes
Crestron Connected™	Yes
Extron XTP	Yes
WEB Browser control	Yes
PJLink™	Yes
Screen Transfer compatible	Yes
Multi Monitoring & Control Software compatible	Yes
Video Wall Manager compatible	Yes
Content management Software compatible	Yes
Auto vertical and horizontal determination (Accelerometer)	Yes

*In case of running for a long time, the moving image is recommended to be displayed. If you display a still picture for an extended period, the image retention might remain on the screen. However, image retention can gradually disappear by displaying a moving images.

REMOTE CONTROL TRANSMITTER

Power Requirements	DC 3 V (2 x AAA Size batteries)
Operating distance	Approx. 7 m (23 ft)*
Weight	Approx. 63 g (2.2 oz) including batteries
Dimensions (W x H x D)	48 x 134 x 20 mm (1.9" x 5.3" x 0.8")

*When operated directly in front of receptor.

DIMENSIONS

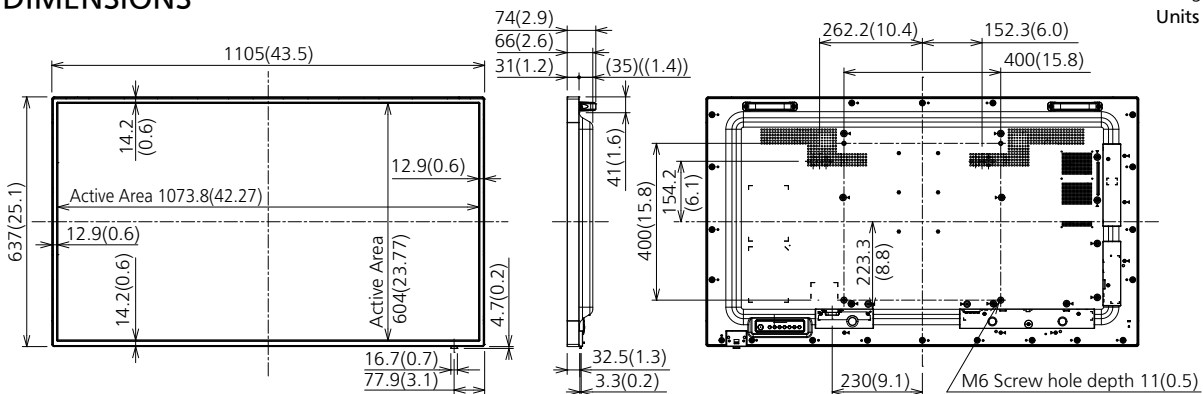

CONNECTION TERMINAL

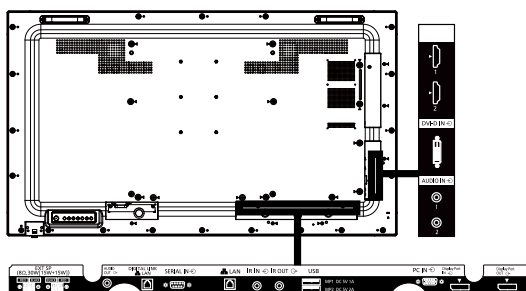

STANDARD (CERTIFICATIONS)

SAFETY REGULATIONS	UL ANSI / UL 62368-1: 2014 , 2nd Edition UL60950-1, 2nd Edition, 2014-10-14 CAN / CSA-C22.2 No. 62368-1-14, 2nd Edition Mexico: NOM
	CB IEC 62368-1: 2014 (Second Edition) IEC 60950-1: 2005 (Second Edition) + Am 1: 2009 + Am 2: 2013 BEAB)
	BEAB) EU Deviation (EN62368-1:2014) (Second Edition) (EN60950-1:2006 + A11:2009 + A1:2010 + A12:2011+A2:2013) BEAB approval
RADIATION REGULATIONS	RCM) AS/NZS Deviation (AS/NZS 62368-1:2018 , Second Edition)
	FCC) FCC CFR 47, Part 15, Subpart B 2015 Class A ANSI C63.4-2014 ICES-003 Issue6: 2016
	CE) EN55032: 2012 EN55024: 2010, EN55035 EN61000-3-2: 2014 EN61000-3-3: 2013
	RCM) AS / NZS CISPR32:2013 RCM Mark

INCLUDED ACCESSORIES

- Remote Control
- Batteries (AAA size) x 2
- Clamper x 3
- USB memory cover x 1
- SDM-S attachment x 1
- AC cord (approx. 2.0 m (79"))
- CD-ROM / User Manual
- Operating Instruction Book

OPTIONAL ACCESSORIES

Pedestal Stand	TY-ST43PE9
Early Warning Software	ET-SWA 100 / 105series
Video wall manager	TY-VUK10
Automatic Display Adjustment Upgrade Kit	

* Specifications and appearance are subject to change without notice.

Correspondence signal	Resolution (dot)	Scan rate		Dot clock rate (MHz)	Format*2	Plug and play compatible signal*5						
		Horizontal (kHz)	Vertical (Hz)			HDMI				DL	DP	DVI-D/PC
						1	2	3	4			
1366 x 768/60	1366 x 768	48.00	60.00	72.00	R/D/H/DL/DP	-	-	-	-	-	-	-
1366 x 768/50	1366 x 768	39.56	49.89	69.00	R/D/H/DL/DP	-	-	-	-	-	-	-
1366 x 768/60	1366 x 768	47.71	59.79	85.50	R/D/H/DL/DP	-	-	-	-	-	-	-
1400 x 1050/60	1400 x 1050	65.22	60.00	122.61	D/H/DL/DP	-	-	-	-	-	-	-
1400 x 1050/75	1400 x 1050	82.20	75.00	155.85	R/D/H/DL/DP	-	-	-	-	-	-	-
1440 x 900/60	1440 x 900	55.47	59.90	88.75	R/D/H/DL/DP	-	-	-	-	-	-	-
1440 x 900/60	1440 x 900	55.92	60.00	106.47	R/D/H/DL/DP	-	-	-	-	-	-	-
1600 x 900/50	1600 x 900	46.30	50.00	97.05	R/D/H/DL/DP	-	-	-	-	-	-	-
1600 x 900/60	1600 x 900	60.00	60.00	108.00	D/H/DL/DP	-	-	-	-	-	-	-
1600 x 900/60	1600 x 900	55.99	59.95	118.25	D/H/DL/DP	-	-	-	-	-	-	-
1600 x 900/60	1600 x 900	55.92	60.00	119.00	D/H/DL/DP	-	-	-	-	-	○	○
1600 x 1200/60	1600 x 1200	75.00	60.00	162.00	R/D/H/DL/DP	-	-	-	-	-	-	-
1680 x 1050/60	1680 x 1050	65.29	59.95	146.25	R/D/H/DL/DP	-	-	-	-	-	-	-
1920 x 1080/60	1920 x 1080 ^{*3}	66.59	59.93	138.50	R/D/H/DL/DP	-	-	-	-	-	-	-
1920 x 1080/60	1920 x 1080	67.50	60.00	148.50	R/D/H/DL/DP	○	○	○	○	○	○	○
1920 x 1200/60	1920 x 1200	74.04	59.95	154.00	R/D/H/DL/DP	○	○	○	○	○	○	○
1920 x 2160/60	1920 x 2160	133.29	59.99	277.25	H/DL/DP	-	-	-	-	-	-	-
1920 x 2160/60	1920 x 2160	135.00	60.00	297.00	H/DL/DP	-	-	-	-	-	-	-
2560 x 1440/60	2560 x 1440	88.79	59.95	241.50	H/DL/DP	-	-	○	-	○	○	-
2560 x 1600/50	2560 x 1600	82.37	49.95	286.00	H/DL/DP	-	-	-	-	-	-	-
2560 x 1600/60	2560 x 1600	98.71	59.97	268.50	H/DL/DP	-	-	-	-	-	-	-
3840 x 1080/60	3840 x 1080	66.63	59.97	266.50	H/DL/DP	-	-	-	-	-	-	-
3840 x 2160/60	3840 x 2160	133.31	60.00	533.25	H/DL/DP	-	-	-	-	-	○	-
3840 x 2160/30	3840 x 2160	65.69	29.98	262.75	H/DL/DP	-	-	-	-	-	○	-

*1 : Pixel-Repetition signal (dot clock frequency 27.0 MHz) only

*2 : Signals to represent formats are as follows.

V : CVBS (AV IN)
R : D-sub RGB (PC IN)
Y : YCbCr/YPbPr (PC IN)
D : DVI-D (DVI-D IN)
H : HDMI (HDMI 1, HDMI 2)
DL : DIGITAL LINK (DIGITAL LINK)
DP : Display Port (Display Port)

*3 : Based on VESA CVT-RB (Reduced Blanking) standard

*4 : YCbCr420 format only supported

*5 : Signals with ○ in the Plug and Play-supported signal column are the ones written in EDID (Extended Display Identification Data) of this unit.
For signals without ○ in the Plug and Play-supported signal column, resolutions may not be selected on the PC side even if this unit supports those signals.

Note

- An auto detected signal format may be differently displayed from the actual input signal.
- [i] shown after the number of dots of resolution means the interlace signal.
- When 1080/30PsF signal and 1080/25PsF signal are input, they are processed as 1080/60i signal and 1080/50i signal, and then displayed.

Drawing of terminals

View from back

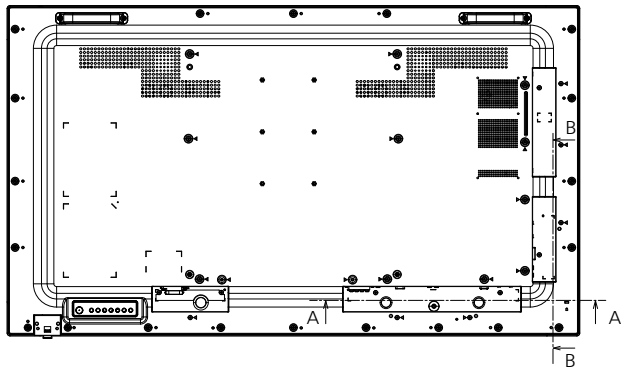

Magnified figure of terminal b

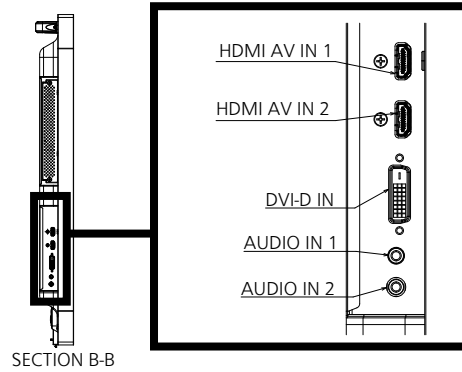

Magnified figure of terminal a

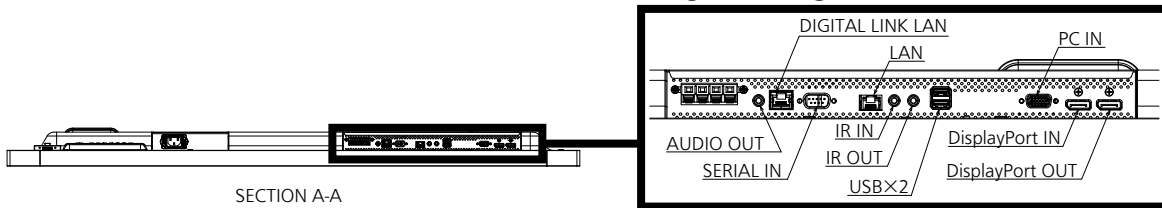

Sectional view of terminal a

(AUDIO OUT / DIGITAL LINK LAN / SERIAL IN / LAN / IR IN / IR OUT / USB / PC IN / DisplayPort IN / DisplayPort OUT)

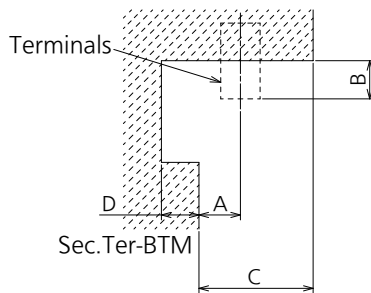

Terminal a
49SQ1W Terminal (Bottom)

Units : mm (inch)

	AUDIO OUT	DIGITAL LINK LAN	SERIAL IN	LAN	IR IN	IR OUT	USB		PC IN	DisplayPort IN	DisplayPort OUT
							USB:1	USB:2			
A	13 (0.51)	13 (0.52)	13 (0.50)	11 (0.42)	13 (0.51)	13 (0.51)	11 (0.42)	19 (0.75)	13 (0.50)	10 (0.39)	10 (0.39)
B	3 (0.10)	—	5 (0.20)	—	3 (0.11)	3 (0.11)	—	—	5 (0.20)	—	—
C											
D											

Sectional view of terminal b

(HDMI AV IN (1/2) / DVI-D IN / AUDIO IN (1/2))

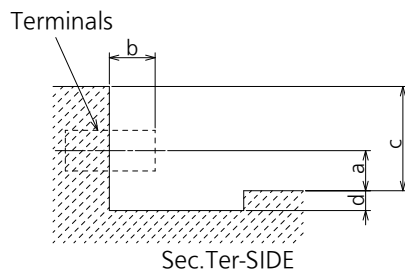

Terminal b
49SQ1W Terminal (Side)

Units : mm (inch)

	HDMI AV IN 1/2	DVI-D IN	AUDIO IN 1/2
A	10 (0.39)	11 (0.45)	13 (0.51)
B	—	6 (0.22)	3 (0.11)
C	35 (1.39)		
D	5 (0.18)		

*Due to the construction of terminal, some types of connecting cable or USB memory device cannot be used. Be sure to use connecting cable or USB memory device after confirmation in this drawing.