

Interactive Flat Panel



TABLE OF CONTENTS

SAFETY.....	4
Safety Instructions.....	4
Copyright.....	5
Disclaimer.....	5
Trademark Recognition.....	5
FCC.....	5
Declaration of Conformity for EU Countries.....	6
WEEE.....	6
INTRODUCTION.....	7
Package Contents.....	7
Standard Accessories.....	7
Optional Accessories.....	7
Product Overview.....	8
Front View.....	8
Rear View.....	9
Remote Control.....	10
SETUP AND INSTALLATION.....	12
Wall Mounting Installation.....	12
Wall Mount Specifications.....	12
Installing an External Mini Computer.....	15
Stand Mounting Installation (Optional).....	16
Using the Remote Control.....	19
Installing/Replacing the Remote Control Batteries.....	19
Remote Control Operating Range.....	20
Making Connection.....	21
Connecting to Power.....	21
Connecting External Devices.....	21
USING THE DEVICE.....	25
Turning the Power On/Off.....	25
Setup Wizard.....	26
BASIC OPERATIONS.....	28
Home Screen Overview.....	28
General Settings.....	29
Selecting an Input Source.....	30
Activating the Low Blue Light Function.....	30
Adjusting the Volume Level.....	31
Adjusting the Backlight Level.....	31
Configuring the Audio Settings.....	32

Configuring the Screen Settings.....	32
Configuring the Display Settings	33
Configure the Adjust Settings (for VGA input only).....	33
Side Toolbar.....	34
Viewing the Recent Tasks	34
Annotations Tool.....	35
Screen Freezing.....	36
Other Utilities.....	37
Cloud Drive.....	42
Advanced Settings.....	43
Configuring the Network Settings.....	44

USING THE APPS..... 46

Note	47
Advanced Options	51
Screenshare	52
ShareSender App Compatibility Table.....	52
Mobile Device.....	52
Computer.....	54
Finder	56
Managing the Files	56
Playing Multimedia Files.....	57
Screen Lock	62
Browser	64
Keeper	64
System Update	65

ADDITIONAL INFORMATION..... 69

Specifications	69
Dimensions.....	71
65-inch.....	71
75-inch.....	72
86-inch.....	73
Supported Timing List.....	74
RS232 Protocol Function List.....	75
RS232 Pin Assignments.....	75
RS232 RJ45 Control Connection	75
SET Command.....	76
GET Command	78
LED Indicator.....	80
Troubleshooting	80
Maintenance.....	81
Cleaning the Screen.....	81
Clean the Front Frame	81
Optoma Global Offices	82

SAFETY

Please follow all warnings, precautions and maintenance as recommended in this user manual.

Safety Instructions

- Only use attachments/accessories specified by the manufacturer.
- Do not block any ventilation openings. To ensure reliable operation of the device and to protect from over heating, it is recommended to install the device in a location that does not block ventilation. Do not put the device in an enclosure such as a book case or a cabinet that restricts air flow.
- Do not use the device near water or moisture. To reduce the risk of fire and/or electric shock, do not expose the device to rain or moisture.
- Do not install near heat sources such as radiators, heaters, stoves or any other apparatus such as amplifiers that emits heat.
- Do not let objects or liquids enter the device. They may touch dangerous voltage ports or short out parts that could result in fire or electric shock.
- Do not place the device on an unstable surface. The device may fall over resulting in injury or the device may become damaged.
- Do not setup the device in places where it might be subjected to vibration or shock.
- Do not use any hard or sharp object to operate the touch screen.
- Do not use the device if it has been physically damaged or abused. Physical damage/abuse would be (but not limited to):
 - The device has been dropped.
 - Power supply cord or plug has been damaged.
 - Liquid has been spilled on to the device.
 - The device has been exposed to rain or moisture.
 - Something has fallen in the device or something is loose inside.
- Do not attempt to service the device yourself. Opening or removing covers may expose you to dangerous voltages or other hazards. Please call Optoma before you send the device for repair.
- Disconnect the power plug from AC outlet if the device is not being used for a long period of time.
- Remove the batteries from the remote control before storage. If the batteries are left in the remote for long periods, they may leak.
- Turn off and unplug the power plug from the AC outlet before cleaning the device.
- Use a soft dry cloth with mild detergent to clean the display housing. Do not use abrasive cleaners, waxes or solvents to clean the device.
- See the device enclosure for safety related markings.
- The device should only be repaired by appropriate service personnel.

Copyright

This publication, including all photographs, illustrations and software, is protected under international copyright laws, with all rights reserved. Neither this manual, nor any of the material contained herein, may be reproduced without written consent of the author.

© Copyright 2018

Disclaimer

The information in this document is subject to change without notice. The manufacturer makes no representations or warranties with respect to the contents hereof and specifically disclaims any implied warranties of merchantability or fitness for any particular purpose. The manufacturer reserves the right to revise this publication and to make changes from time to time in the content hereof without obligation of the manufacturer to notify any person of such revision or changes.

Trademark Recognition

Kensington is a U.S. registered trademark of ACCO Brand Corporation with issued registrations and pending applications in other countries throughout the world.

HDMI, the HDMI Logo, and High-Definition Multimedia Interface are trademarks or registered trademarks of HDMI Licensing LLC in the deviceeeced States and other countries.

Google, the Google logo, and Google Drive are trademarks or registered trademarks of Google LLC.

OneDrive is a trademark and brand of Microsoft Corporation.

All other product names used in this manual are the properties of their respective owners and are Acknowledged.

FCC

This device has been tested and found to comply with the limits for a Class B digital device pursuant to Part 15 of the FCC rules. These limits are designed to provide reasonable protection against harmful interference in a residential installation. This device generates, uses and can radiate radio frequency energy and, if not installed and used in accordance with the instructions, may cause harmful interference to radio communications.

However, there is no guarantee that interference will not occur in a particular installation. If this device does cause harmful interference to radio or television reception, which can be determined by turning the device off and on is encouraged to try to correct the interference by one or more of the following measures:

- Reorient or relocate the receiving antenna.
- Increase the separation between the device and receiver.
- Connect the device into an outlet on a circuit different from that to which the receiver is connected.
- Consult the dealer or an experienced radio/television technician for help.

Notice: Shielded cables

All connections to other computing devices must be made using shielded cables to maintain compliance with FCC regulations.

Caution

Changes or modifications not expressly approved by the manufacturer could void the user's authority, which is granted by the Federal Communications Commission, to operate this projector.

Operation Conditions

This device complies with Part 15 of the FCC Rules. Operation is subject to the following two conditions:

1. This device may not cause harmful interference and
2. This device must accept any interference received, including interference that may cause undesired operation.

Notice: Canadian users

This Class B digital apparatus complies with Canadian ICES-003.

Remarque à l'intention des utilisateurs canadiens

Cet appareil numérique de la classe B est conforme à la norme NMB-003 du Canada.

Declaration of Conformity for EU Countries

- EMC Directive 2014/30/EC (including amendments)
- Low Voltage Directive 2014/35/EC
- R & TTE Directive 1999/5/EC (if product has RF function)

WEEE**Disposal instructions**

Do not throw this electronic device into the trash when discarding. To minimize pollution and ensure utmost protection of the global environment, please recycle it.

INTRODUCTION

Package Contents

Carefully unpack and verify that you have the items listed below under standard accessories. Some of the items under optional accessories may not be available depending on the model, specification and your region of purchase. Please check with your place of purchase. Some accessories may vary from region to region.

The warranty card is only supplied in some specific regions. Please consult your dealer for detailed information.

Standard Accessories

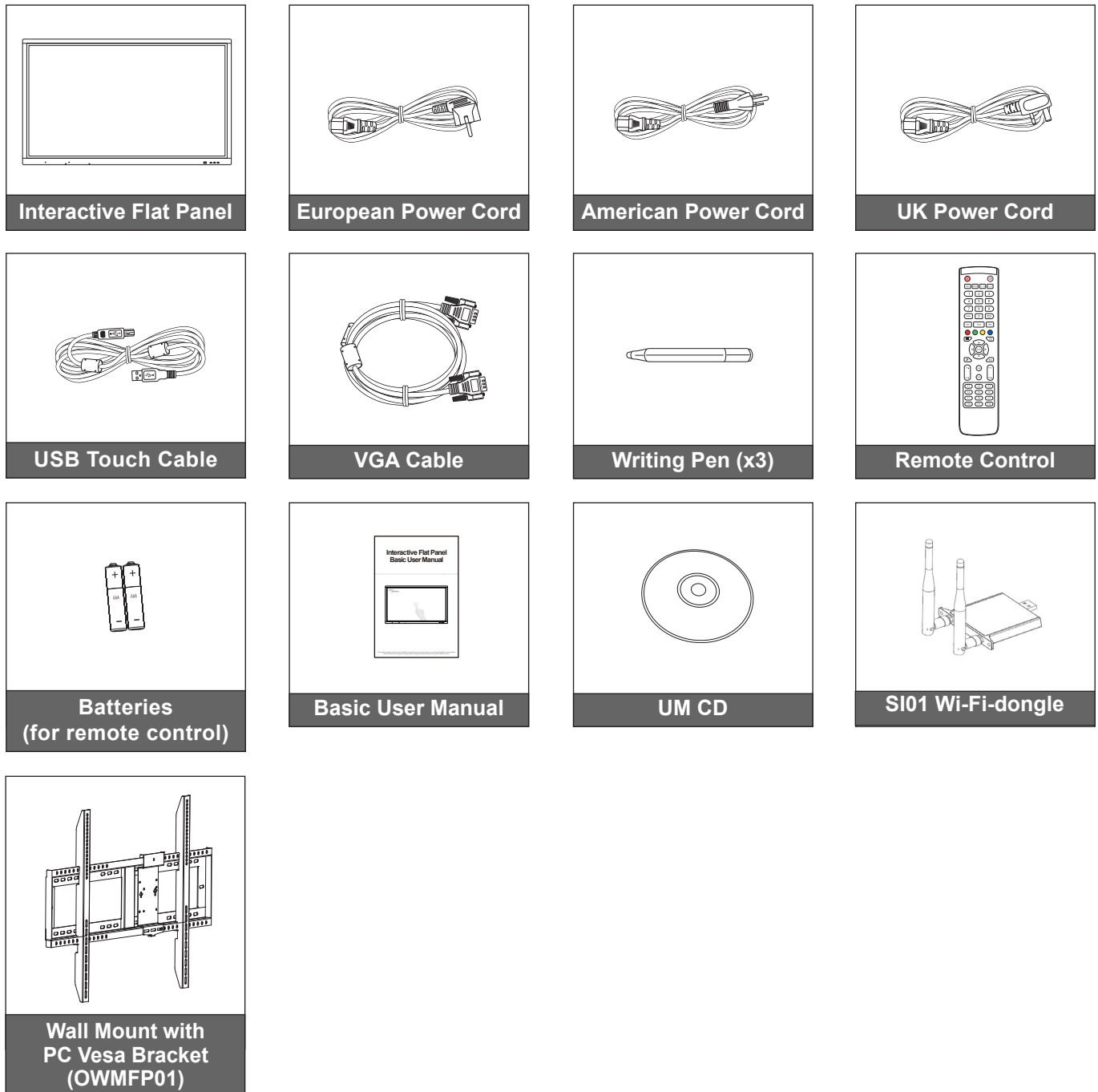

Optional Accessories

- ST01 (Stand)
- OMPC-i5 (slot in PC, intel i5 CPU, 8G RAM, 128G SSD)
- OMPC-i7 (slot in PC, intel i7 CPU, 8G RAM, 256G SSD)

Note: For European warranty Information, please visit www.optoma.com.

INTRODUCTION

Product Overview

Front View

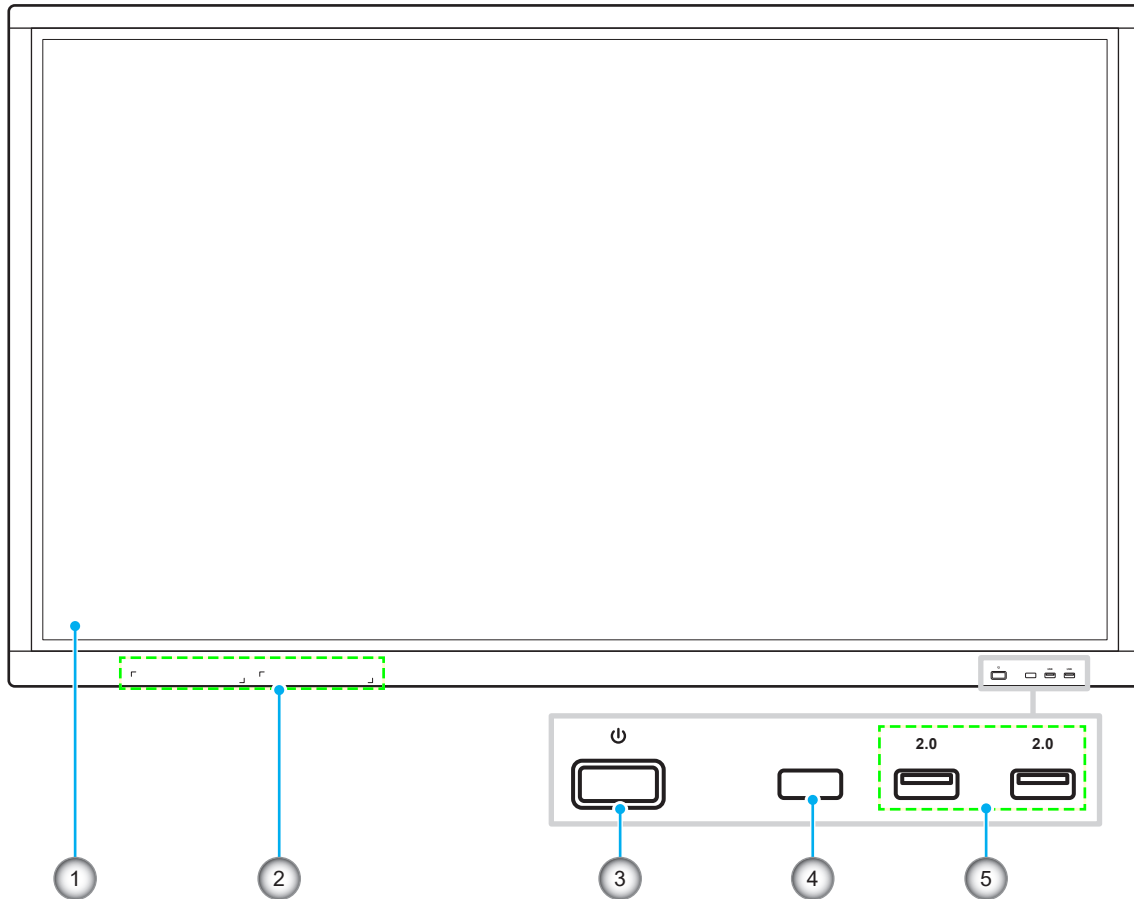

No.	Item
1.	Touch screen
2.	Writing pen placements (x2)
3.	Power button with LED indicator

No.	Item
4.	IR receiver
5.	USB 2.0 ports (x2)

Note: The front USB 2.0 ports are full channel USB ports. USB ports can be used irrespective of the chosen input source.

INTRODUCTION

Rear View

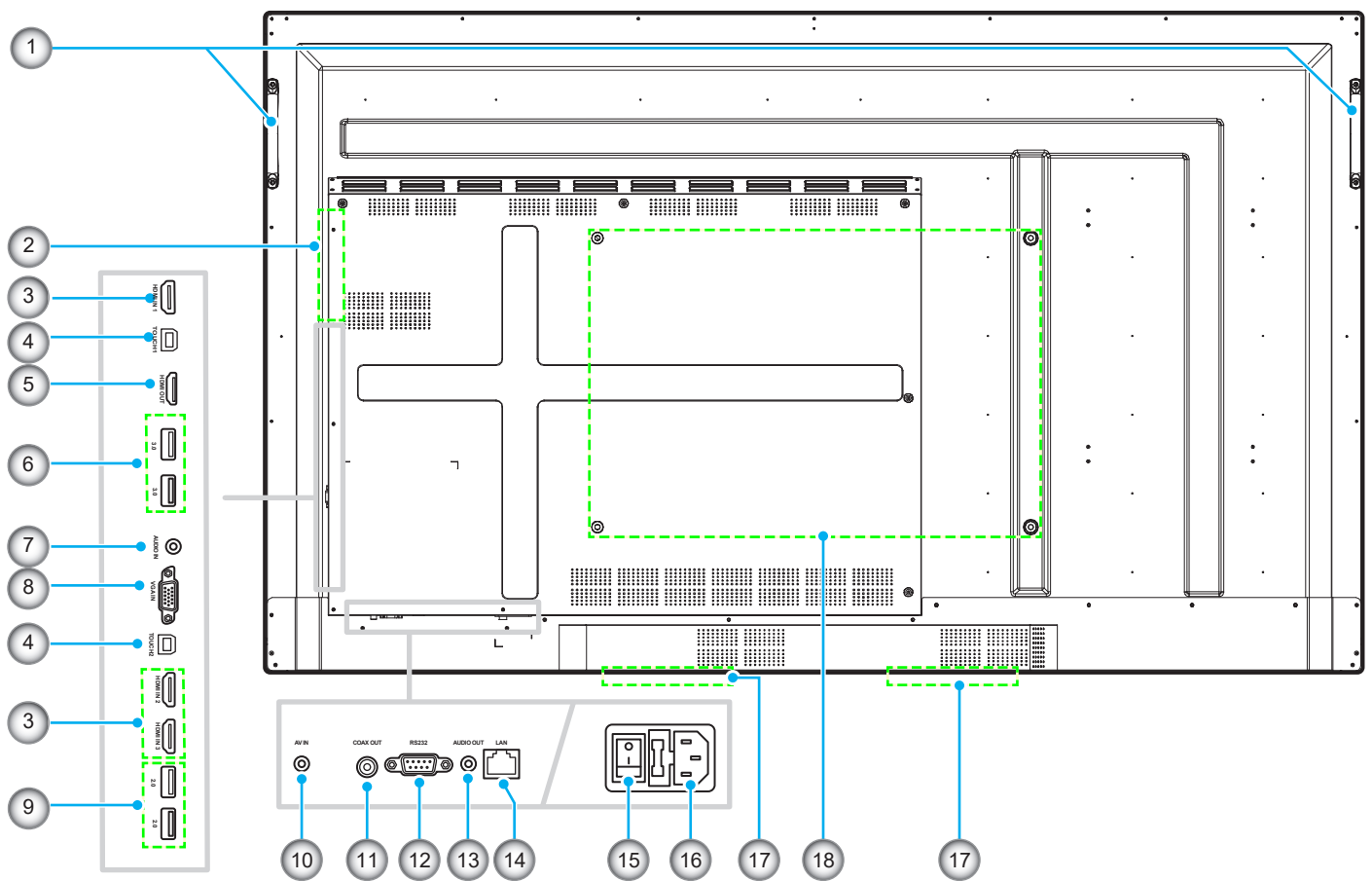

No.	Item
1.	Handles (x2)
2.	OPS slot
3.	HDMI 2.0 ports (x3)
4.	Touch USB ports (x2)
5.	HDMI Out port
6.	USB 3.0 ports (x2)
7.	Audio In jack
8.	VGA port
9.	USB 2.0 ports (x2)

No.	Item
10.	Composite Video jack
11.	Coaxial Out jack
12.	RS232 port
13.	Audio Out jack
14.	LAN port
15.	Power switch
16.	AC In socket
17.	12W speakers (x2)
18.	Mounting holes for wall mount

INTRODUCTION

Remote Control

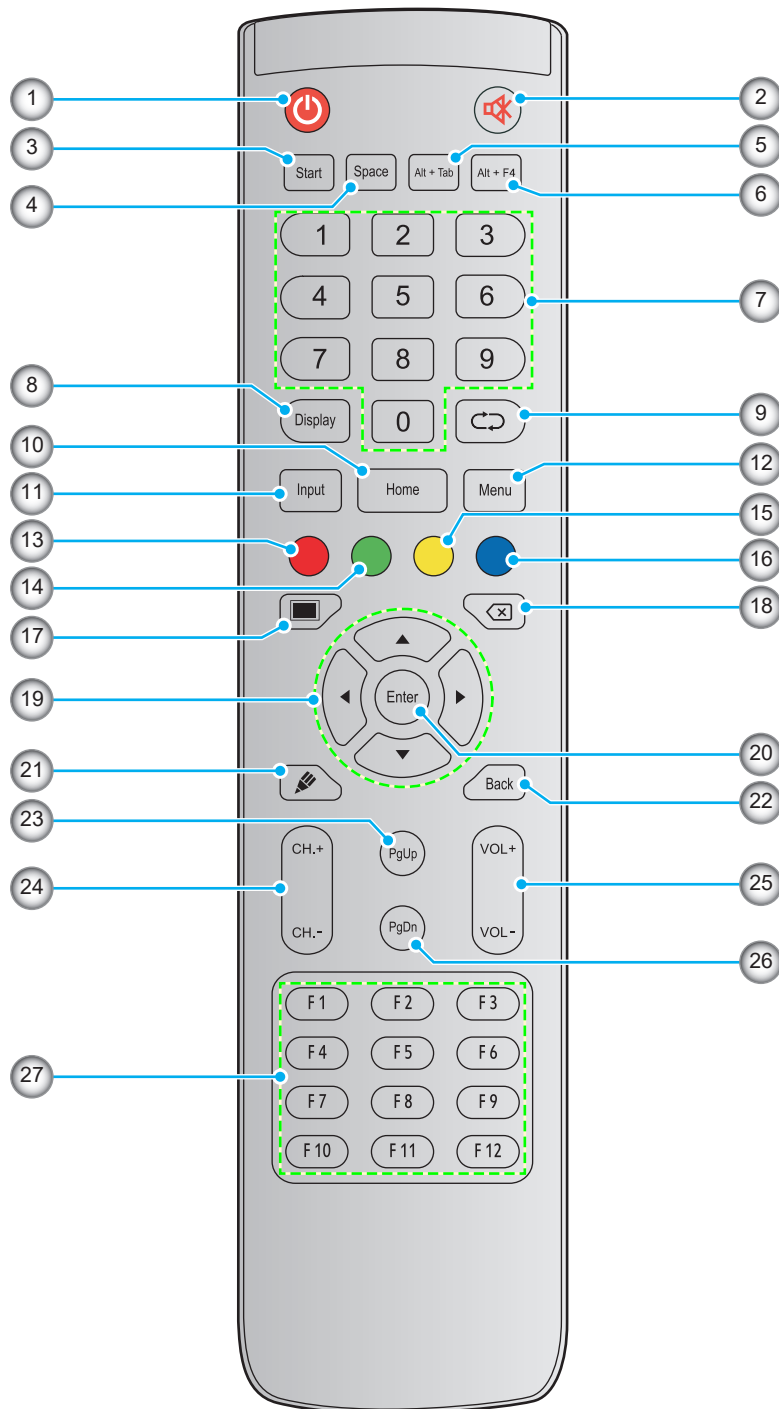

No.	Button	Description
1.	Power (🔌)	Turn on/off the device.
2.	Mute (🔇)	Turn off the sound temporarily.
3.	Start	Perform the same function as the Windows key on a computer keyboard.
4.	Space	Perform the same function as the Space key on a computer keyboard.
5.	Alt+Tab	Perform the same function as the Alt and Tab keys on a computer keyboard. Pressing both keys, you can switch between all open applications (windows).

INTRODUCTION

No.	Button	Description
6.	Alt+F4	Perform the same function as the Alt and F4 keys on a computer keyboard. Pressing both keys, you can close the current window.
7.	Numeric keys	Numeric input keys
8.	Display	Show the current input source and information.
9.	Repeat (↵)	No function.
10.	Home	Return to the Home screen.
11.	Input	Select the input source.
12.	Menu	Display or hide the OSD menu.
13.	Red (●)	Lock or unlock the Power button (on the device) and touch functions.
14.	Green (●)	Lock or unlock the Power button (on the device) function.
15.	Yellow (●)	Lock or unlock the touch function.
16.	Blue (●)	Freeze the screen.
17.	Blank (■)	Blank the screen.
18.	Backspace (⌫)	Perform the same function as the Backspace key on a computer keyboard.
19.	Navigation keys (▲▼◀▶)	Select an item or option.
20.	Enter	Confirm the selection.
21.	Note(📝)	Launch the Note app.
22.	Back	Return to the previous screen.
23.	PgUp	Perform the same function as the PgUp key on a computer keyboard.
24.	Channel keys	No function.
25.	Volume keys	Adjust the volume level.
26.	PgDn	Perform the same function as the PgDn key on a computer keyboard.
27.	Function keys (F1 ~ F12)	Perform the same function as the F1 ~ F12 function keys on a computer keyboard.

Note: If the PC module is not installed into the OPS slot, all computer-related keys will have no function.

SETUP AND INSTALLATION

Wall Mounting Installation

Use only the supplied wall mount kit. It includes the following items:

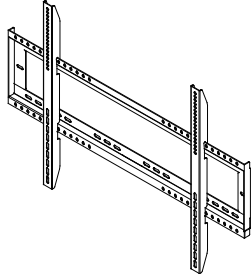

Dual mounting brackets and wall mount



Screw A (x4)



Screw B (x8)



Screw C (x2)



Anchor (x8)



Washer (x8)

Wall Mount Specifications

Model Name	VESA Grid	Screw Type & Length
65-inch	600 x 400 mm	M8*25L
75-inch	800 x 400 mm	M8*25L
86-inch	800 x 600 mm	M8*25L

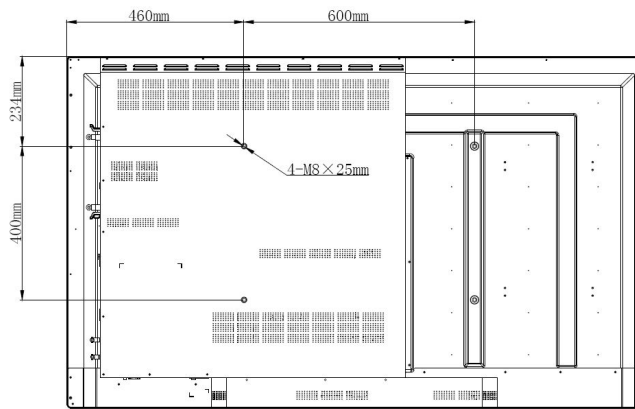

65-inch

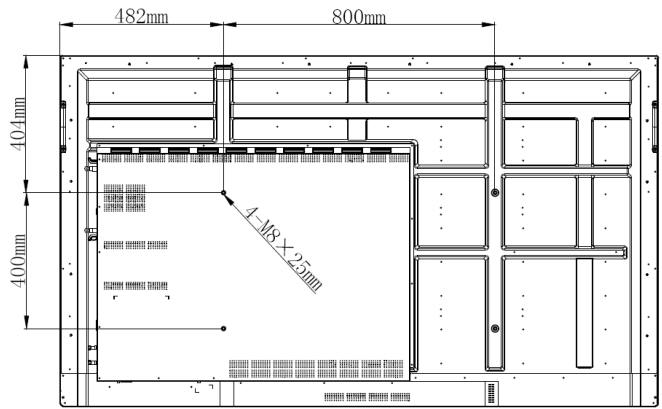

75-inch

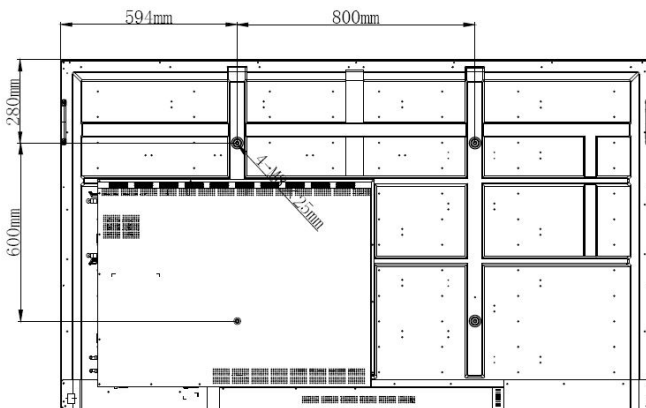

86-inch

SETUP AND INSTALLATION

To mount the device on the wall, complete the following steps:

1. Install the dual mounting brackets on the rear of the device. Then secure the brackets with four screws (A).

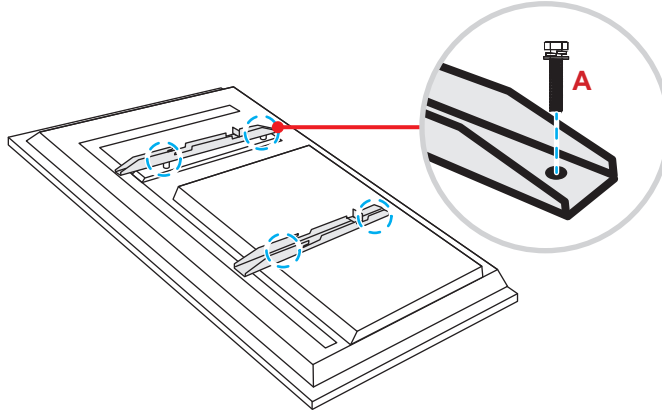

2. Drill eight small holes on the mounting location and insert the anchors into the holes.

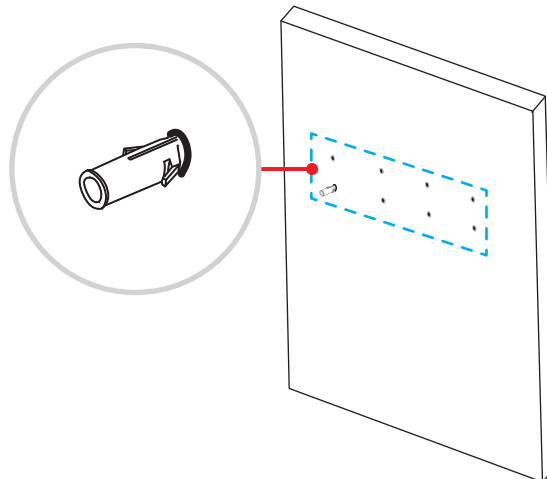

3. Position the wall mount on the wall. Then secure the wall mount with eight screws (B) through the washers into the installed anchors on the wall.

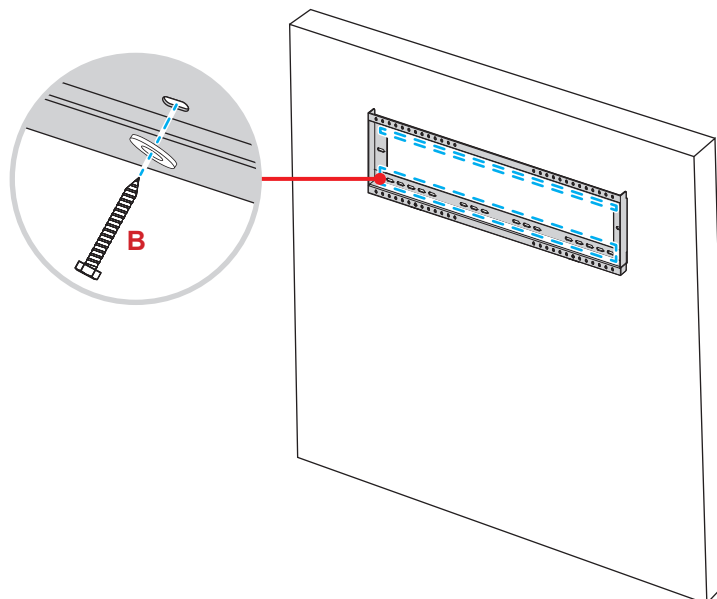

SETUP AND INSTALLATION

4. Align and hook the dual mounting brackets to the wall mount.

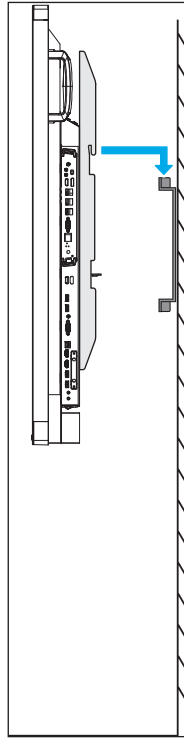

5. Secure the dual mounting brackets and the wall mount with two screws (C).

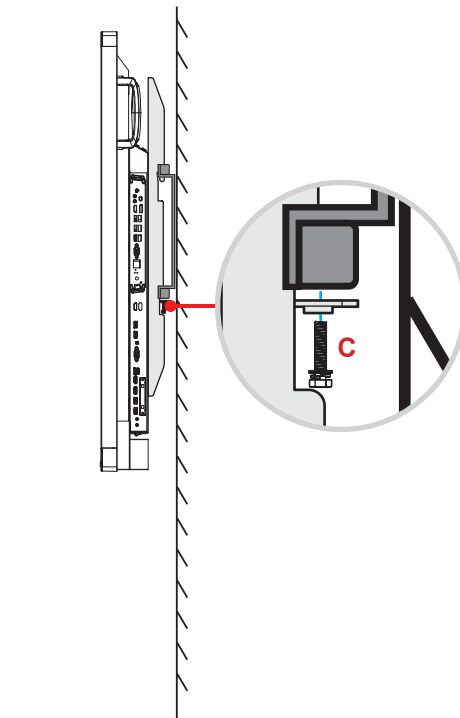

Note:

- The maximum wall mount kit load capacity: 160kg (352lbs).
- The wall mount should be installed into concrete wall to ensure installation firmness.
- Screws must be tightly secured. However, to avoid damage to the mounting brackets, wall mount, or device, do not overtighten the screws.
- The installation should only be performed by qualified technicians. Improper installation may cause the device to fall or malfunction.
- Please note that damage resulting from incorrect installation will void the warranty.

SETUP AND INSTALLATION

Installing an External Mini Computer

Install the mini PC bracket on the rear side of the wall mount. Then complete one of the following to install the mini computer:

- Install the screws onto the mini computer. Then align and hook the mini computer to the mini PC bracket.
- Align and install the mini computer to the mini PC bracket. Then secure it with four screws.

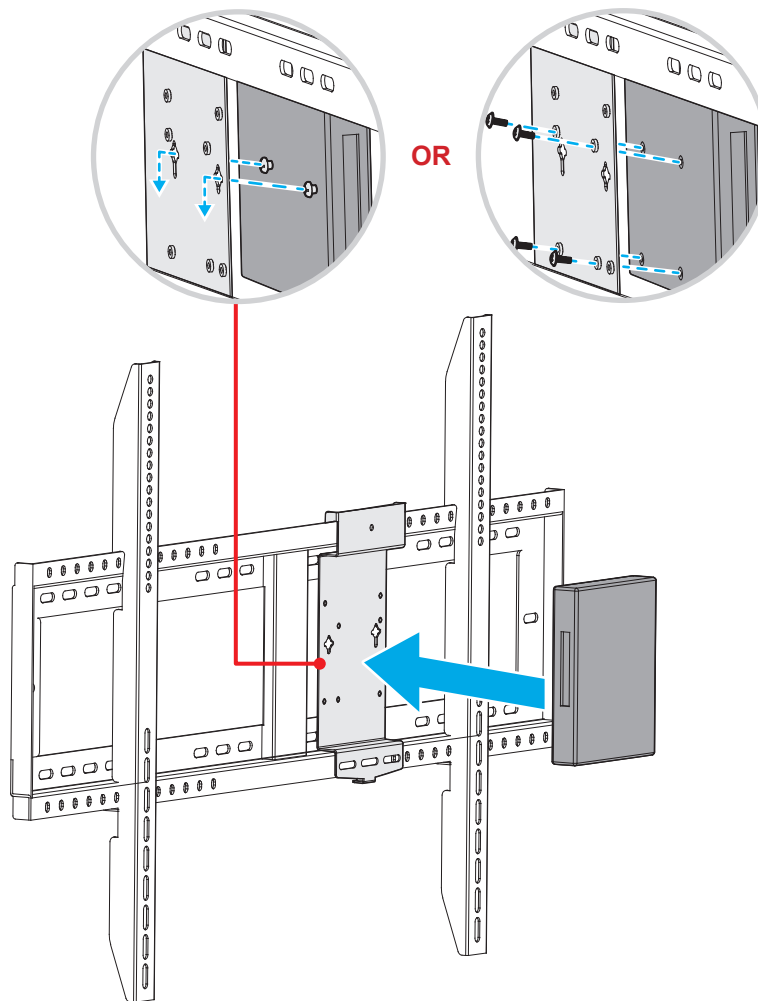

SETUP AND INSTALLATION

Stand Mounting Installation (Optional)

The stand mount kit includes the following items:

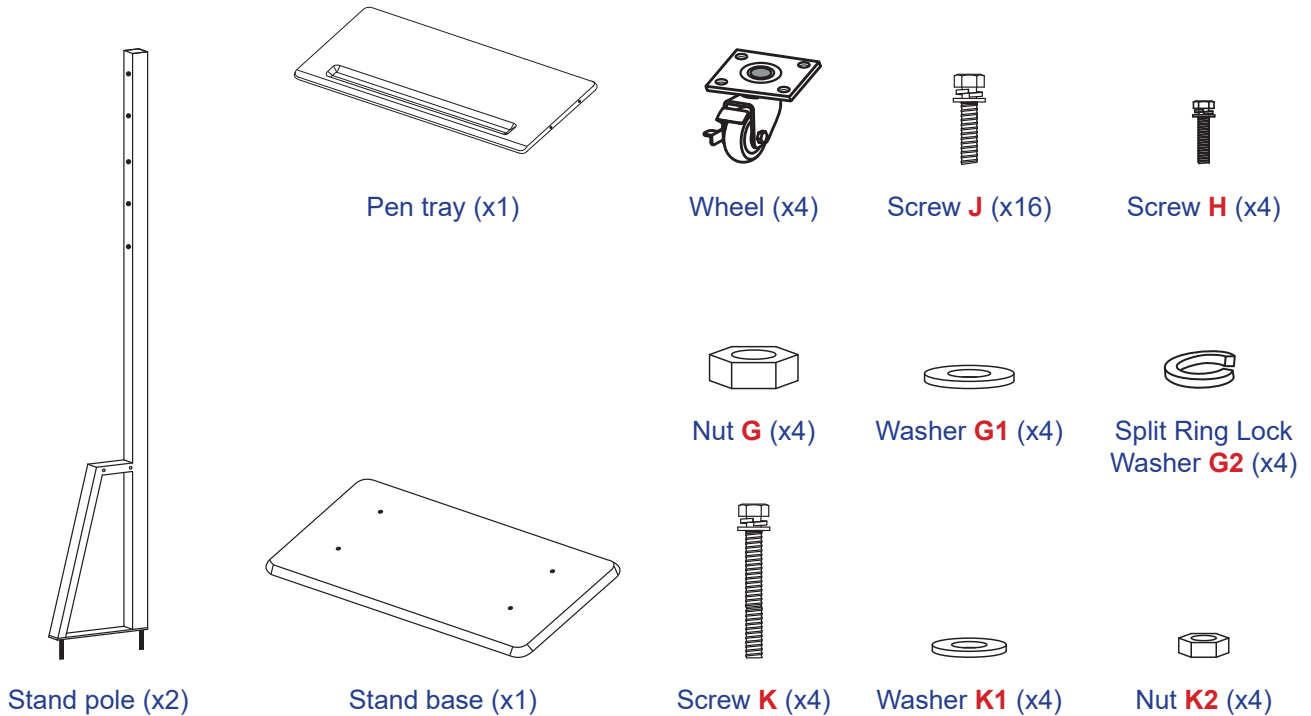

To mount the device on the stand, complete the following steps:

1. Install the dual mounting brackets on the rear of the device. Then secure the brackets with four screws (A).

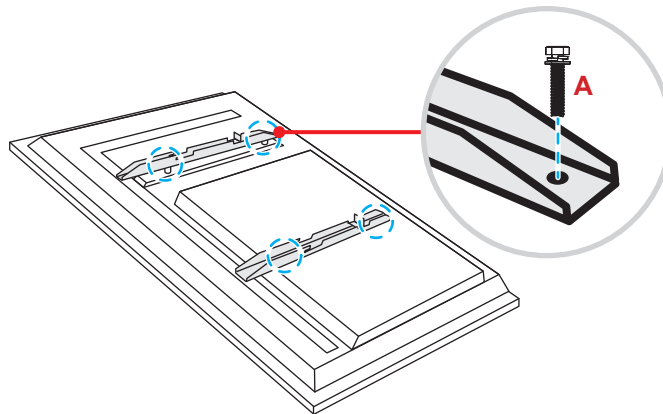

Note: Dual mounting brackets, wall mount, and screws (A) are included in the wall mount kit. Refer to “Wall Mounting Installation” on page 12.

SETUP AND INSTALLATION

2. Flip the stand base so that you can see the screw holes for the wheel. Then install the wheel onto its slot and secure it with four screws (**J**).
Repeat the same procedure to install the remaining three wheels.

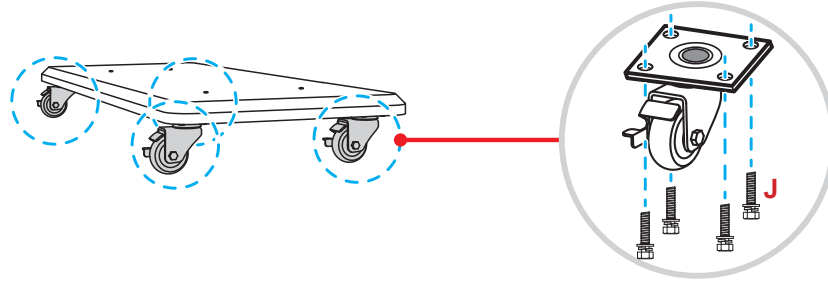

3. Place the stand base on the stable surface. Then install the stand pole onto its slot and secure both standoffs with two nuts (**G**) through the washers (**G2** and **G1**).
Repeat the same procedure to install another stand pole.

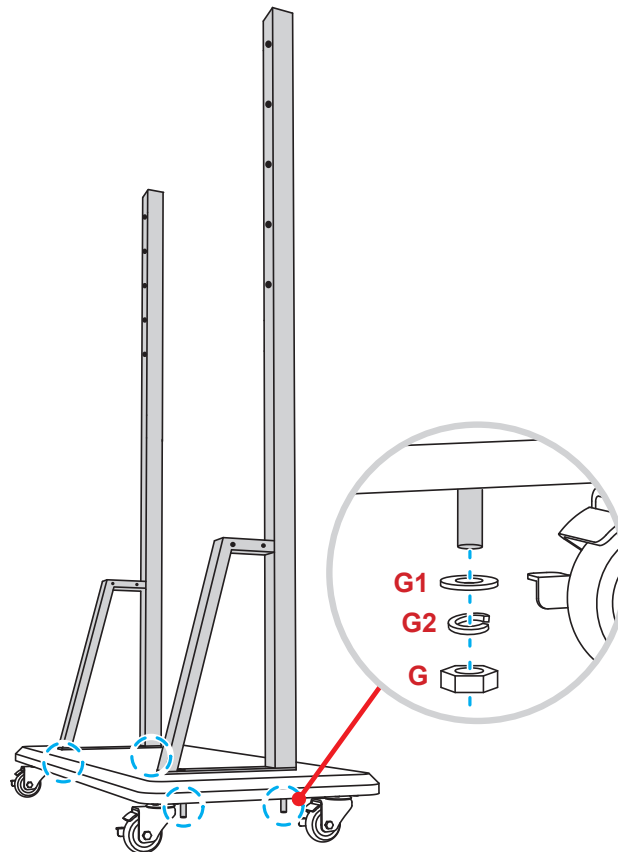

SETUP AND INSTALLATION

4. Align the pen tray with the screw holes on the middle part of the poles. Then secure the pen tray with four screws (**H**).
5. Install the wall mount on the upper part of the poles. Then insert the screws (**K**) through the screw holes from the rear side of the poles.
6. Place the washers (**K1**) and the nuts (**K2**) into the screws. Then tighten the nuts (**K2**) to secure the wall mount in place.

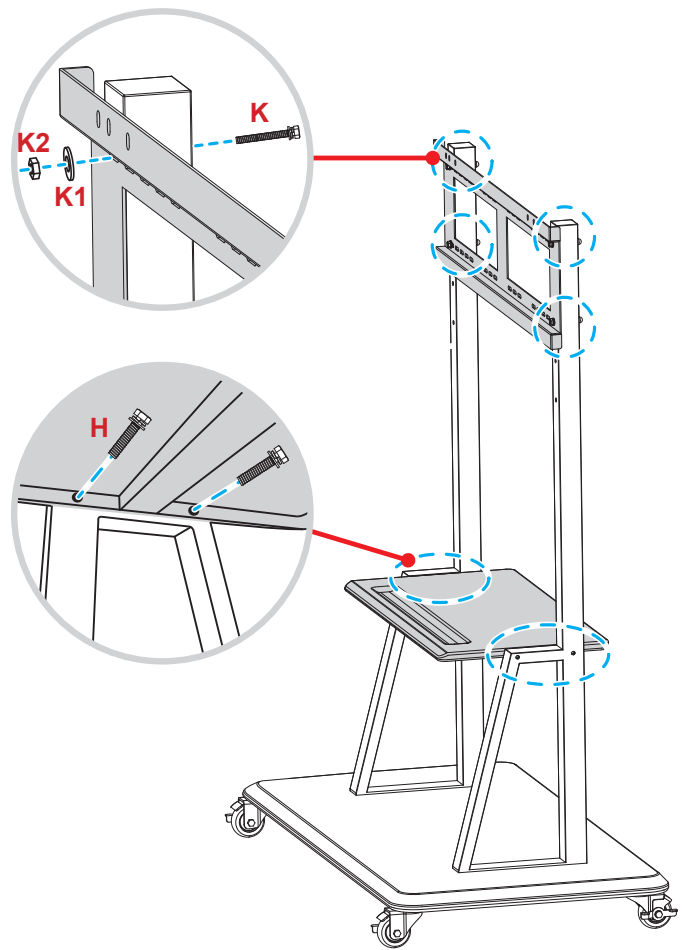

7. Align and hook the dual mounting brackets to the installed wall mount on the stand poles.

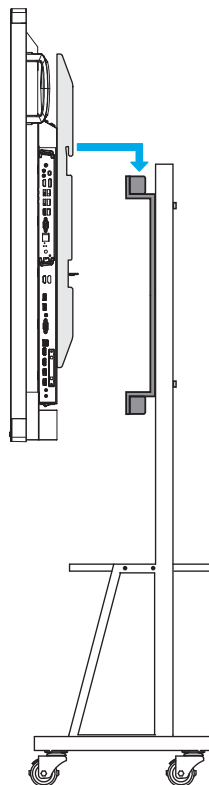

SETUP AND INSTALLATION

Using the Remote Control

Installing/Replacing the Remote Control Batteries

Two AAA size batteries are supplied for the remote control.

IMPORTANT! *Replace only with the same or equivalent type batteries.*

1. Remove the cover of the battery compartment.

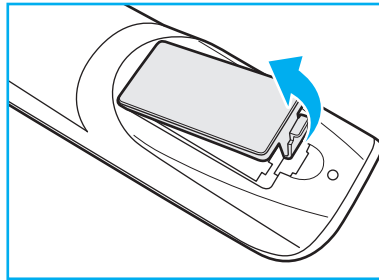

2. Insert the two batteries with correct polarity (+/-) as shown inside the battery compartment.

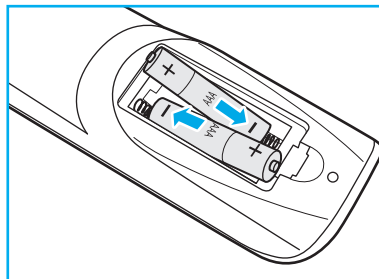

3. Replace the cover.

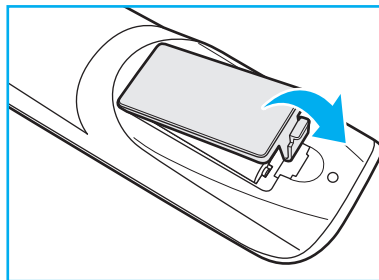

CAUTION

Improper use of batteries can result in chemical leakage or explosion. Be sure to follow the instructions below.

- Do not mix batteries of different types. Different types of batteries have different characteristics.
- Do not mix old and new batteries. Mixing old and new batteries can shorten the life of new batteries or cause chemical leakage in old batteries.
- Remove batteries as soon as they are depleted. Chemicals that leak from batteries that come in contact with skin can cause a rash. If you find any chemical leakage, wipe thoroughly with a cloth.
- The batteries supplied with this product may have a shorter life expectancy due to storage conditions.
- If you will not be using the remote control for an extended period of time, remove the batteries.
- When you dispose of the batteries, you must obey the law in the relative area or country.

SETUP AND INSTALLATION

Remote Control Operating Range

When using the remote control, make sure to point it within $\pm 30^\circ$ to the IR receiver on the device. The distance between the remote control and the IR sensor window should not be longer than 8 meters.

- Make sure that there are no obstacles between the remote control and the IR sensor window on the device that might obstruct the infra-red beam.
- Make sure the IR transmitter of the remote control is not being used in sunlight or fluorescent lamps directly.
- If the remote control is closed to Inverter-Type fluorescent lamps, it might become ineffective from time to time.
- If the remote control and the device are within a very short distance, the remote control might become ineffective.

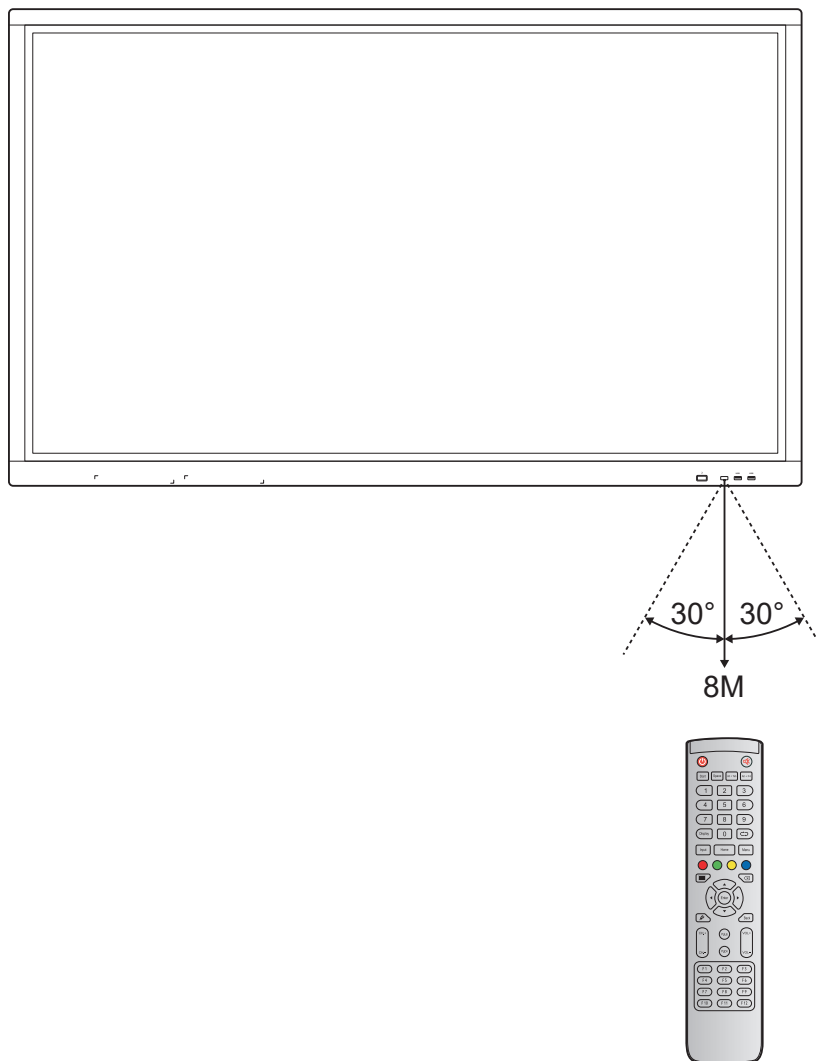

SETUP AND INSTALLATION

Making Connection

Connecting to Power

1. Connect one end of the power cord to the AC In socket of the device.
2. Connect the other end of the power cord to a power outlet or a power supply.
3. Set the **Power** switch to ON (I). The device will automatically enter standby mode.



Connecting External Devices

IMPORTANT! To use the touch screen function, make sure to connect one end of the USB cable to the Touch USB port of the device and the other end of the cable to the USB port of your external device.

HDMI input connection

- Connect your computer to the device using an HDMI cable.

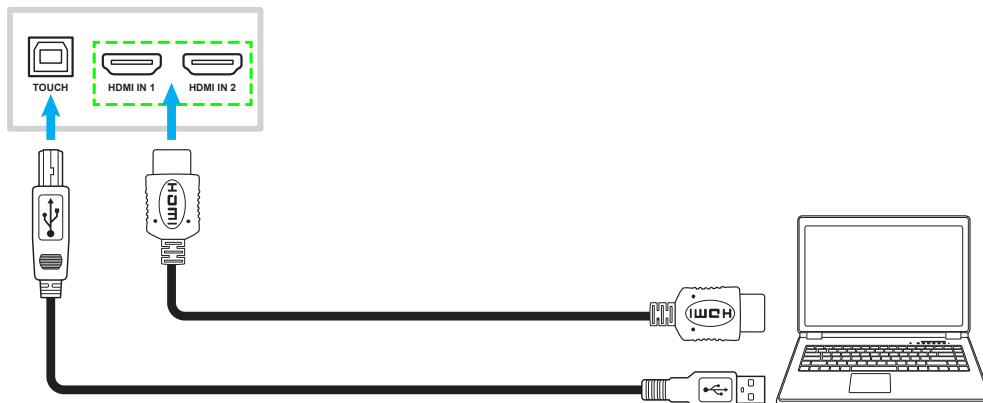

- Connect your video source to the device using an HDMI cable.



SETUP AND INSTALLATION

VGA input connection

Connect your computer to the device using a VGA cable.

Note: For audio input, connect one end of an audio cable to the Audio In jack of the device and the other end of the cable to the audio jack of your computer.

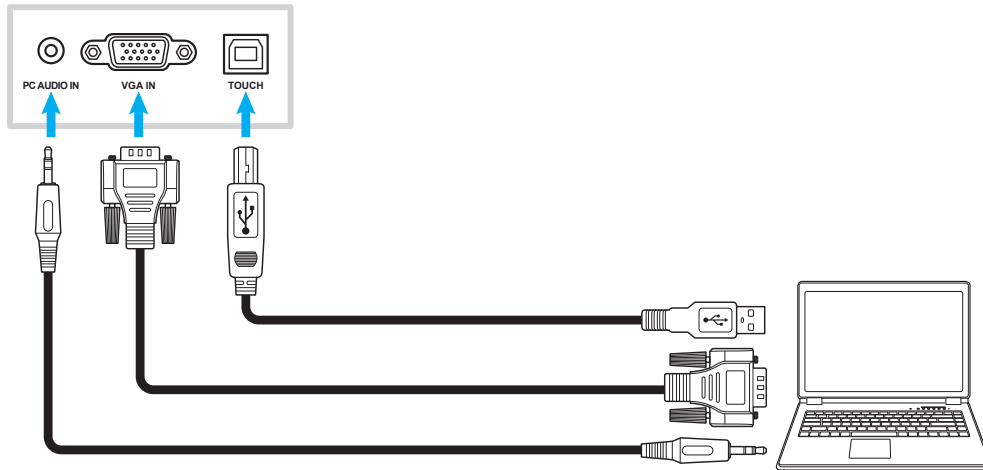

AV input connection

Connect your A/V device to the device using an appropriate video cable.

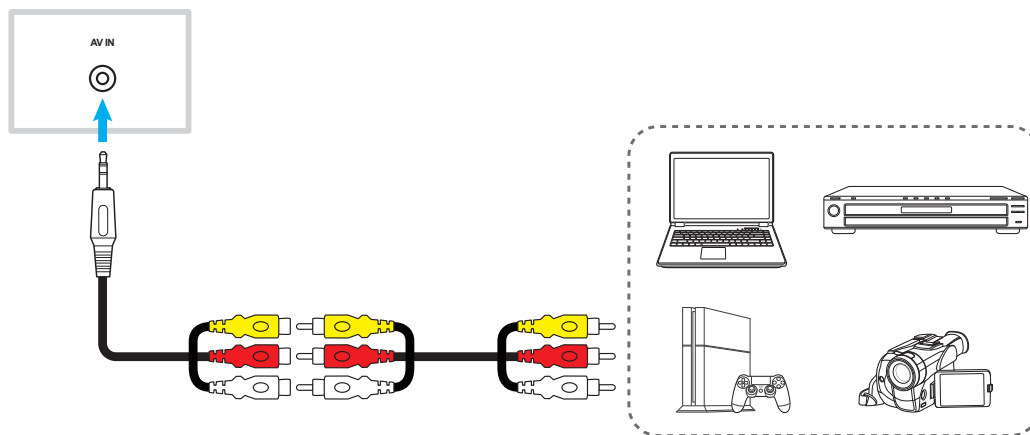

Audio output connection

Connect your external speakers to the device using an audio cable.



SETUP AND INSTALLATION

Coaxial output connection

Connect your audio equipment to the device using a coaxial cable.

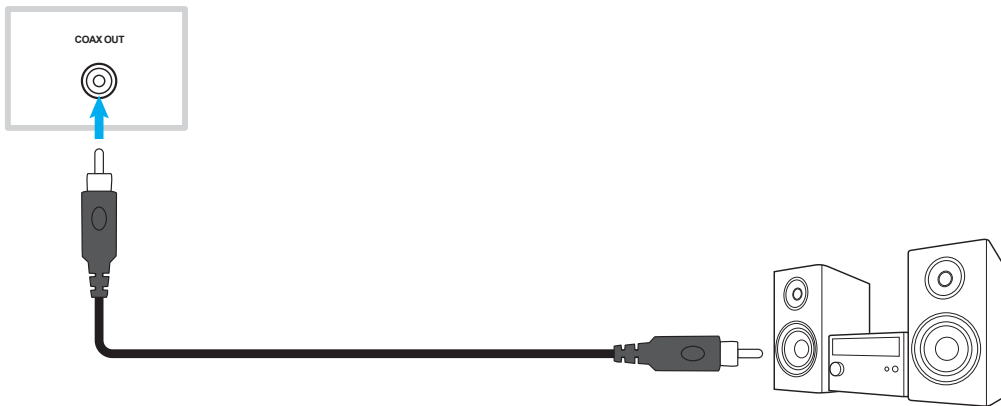

HDMI output connection

Connect your projector to the device using an HDMI cable.

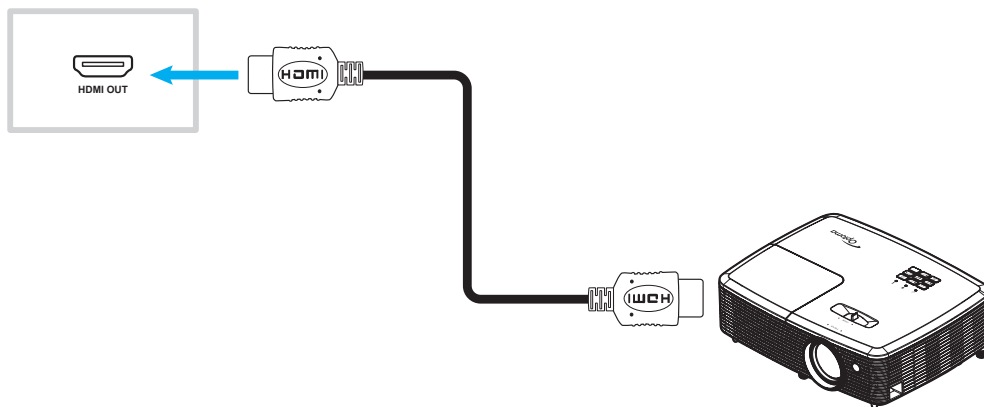

USB connection

Connect your USB peripheral device to the device using a USB cable.

Note: For the USB disk drive or Wi-Fi dongle connection, simply plug it into one of the available USB ports.

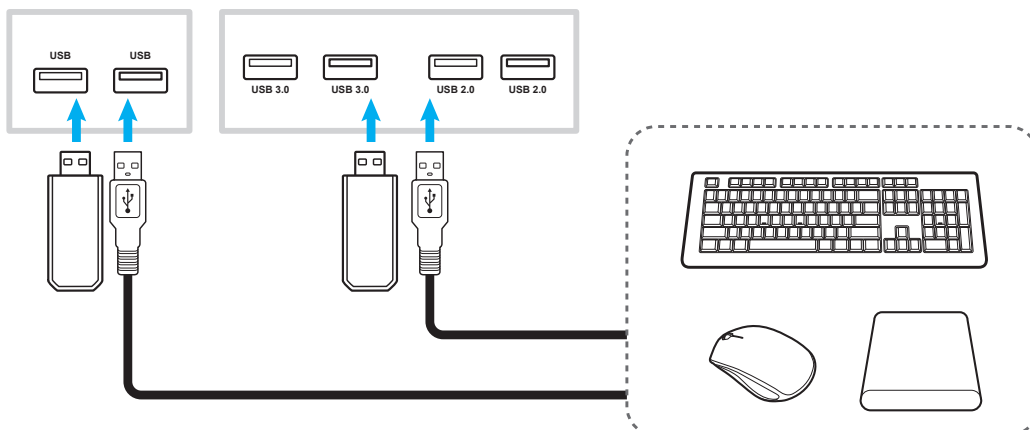

SETUP AND INSTALLATION

RS232 connection

Connect your computer to the device using a RS232 cable.



LAN connection

Connect your router to the device using an Ethernet cable.



Wi-Fi connection

Plug the Wi-Fi dongle into one of the rear USB ports. It can receive the signal in the area where there is Wi-Fi network.

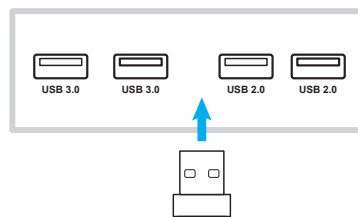

USING THE DEVICE

Turning the Power On/Off

Powering on

Note: After the power cord is properly connected, make sure the **Power** switch to ON (I).



Press the **Power** button to turn on the device. The LED indicator lights blue, indicating it is ready to use.

Note: You can also press the  button on the remote control to turn on the device.

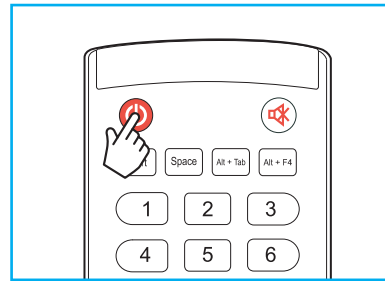
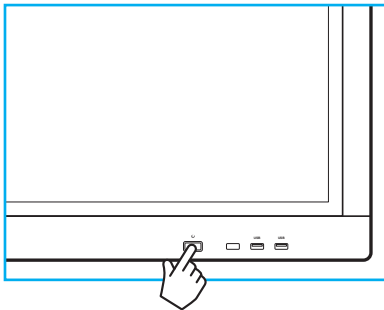

Powering off

Press the **Power** button for 3 seconds to turn off the device. When the LED indicator lights red, this indicates the device has entered standby mode.

Note:

- You can also press the  button on the remote control to turn off the device.
- The device still consumes power when it is in standby mode. It is highly recommended to unplug the power cord from the power outlet if the device will not be used for an extended period of time.

USING THE DEVICE

Setup Wizard

The Setup Wizard will appear on the screen when you turn on your device for the first time.

Note: This device is equipped with a touch-sensitive screen. You can simply tap the touch screen to operate your device.

1. Select the language for the on-screen display (OSD) menu.

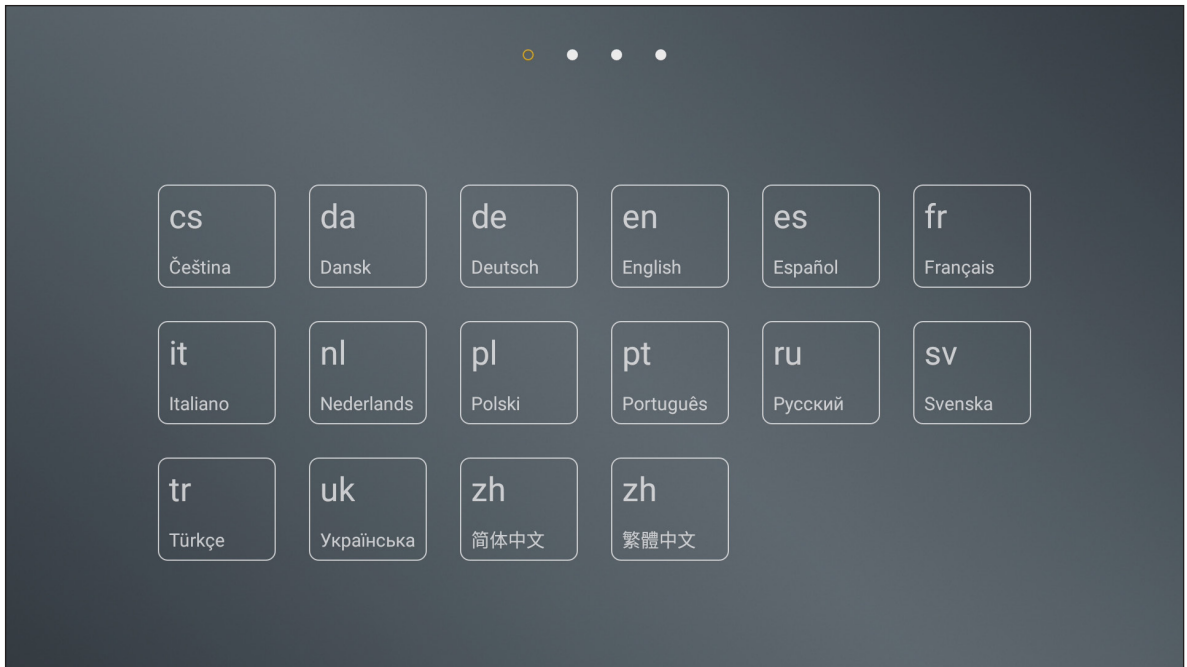

2. If you want to connect your device to the Internet, select one of the available networks and tap **CONNECT**. Otherwise, select **SKIP**.

IMPORTANT!

- To connect to a wireless network, make sure the Wi-Fi dongle is properly plugged into one of the USB ports.
- If you connect to a secure network, you have to enter the password at first-time connection only.

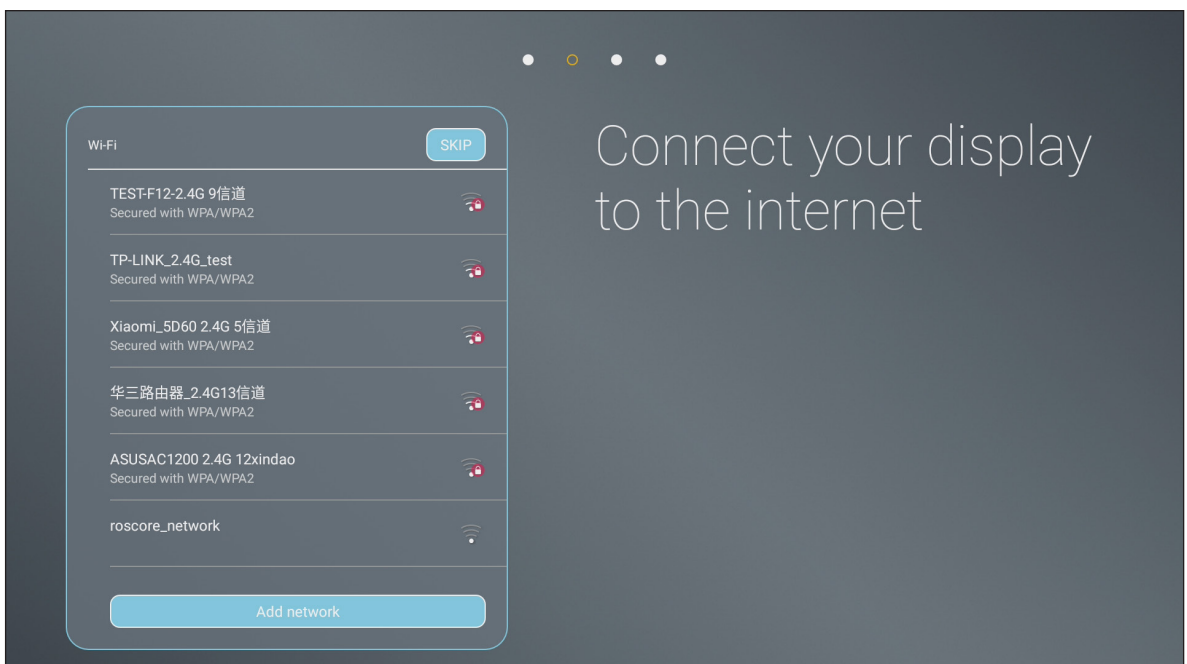

USING THE DEVICE

3. Configure the date and time related settings. Then select **NEXT** to continue.



4. Read Optoma practices, including Terms and Conditions of Use, Privacy Policy, and Cookie Policy. Then tap **AGREE** to complete setup. The device is now ready to use.

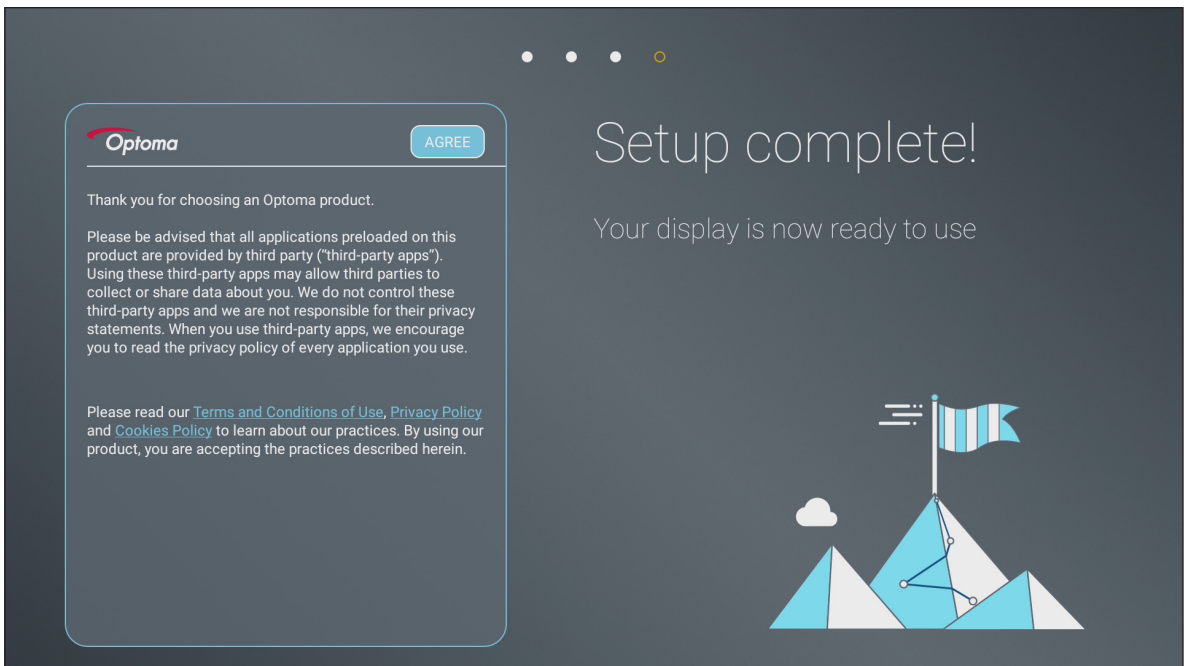

BASIC OPERATIONS

Home Screen Overview

The Home screen is displayed every time you start the device.

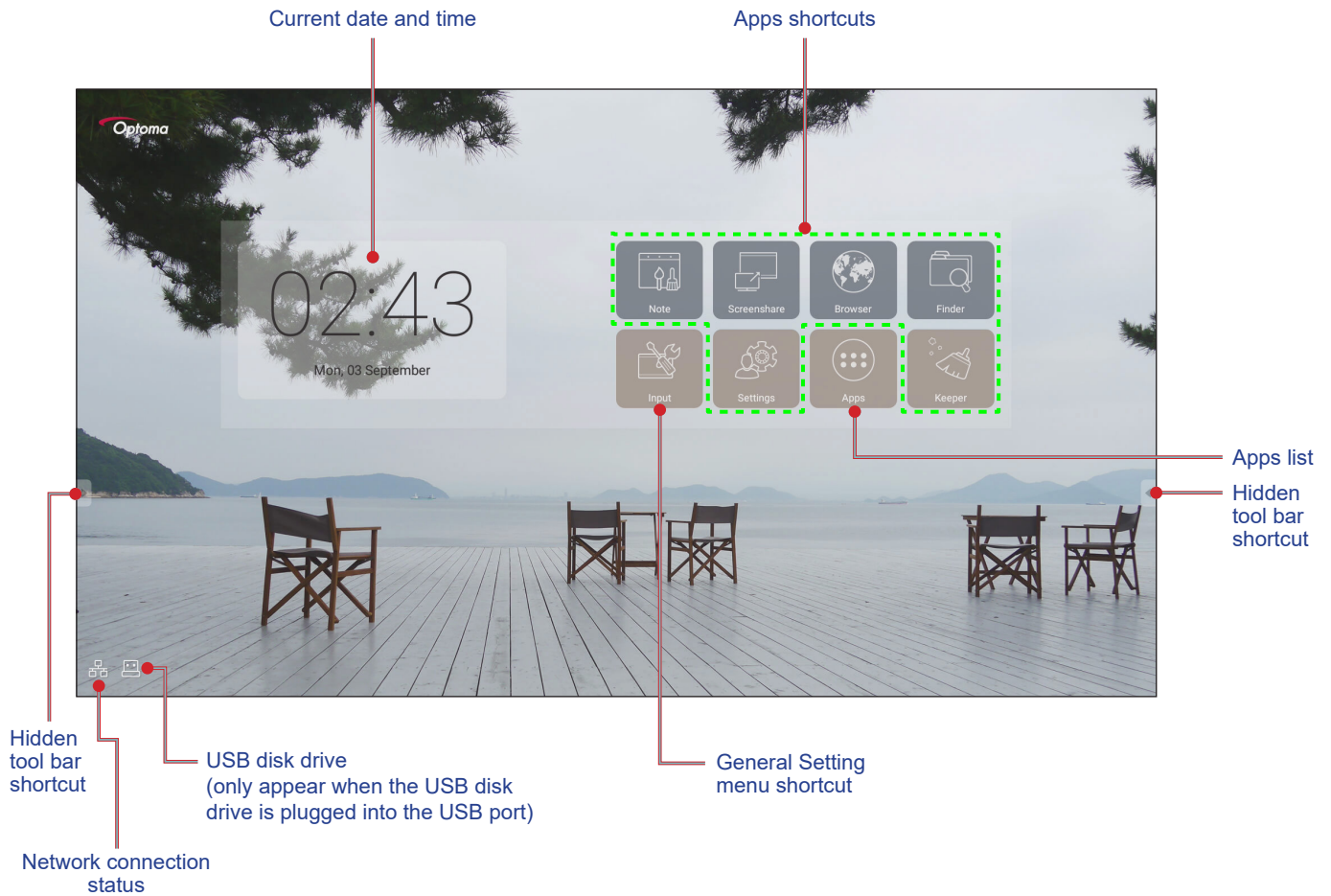

To navigate the Home screen, you can do the following:

- Select an option: simply tap the desired item.
- Adjust the setting: drag the slider to the left/right or clockwise/counter-clockwise.
- Open the hidden toolbar: tap **◀** or **▶** on the left/right side on the screen.

Note:

- *Unless otherwise specified, this section describes the device operations using the touch gesture.*
- *As an alternative, you can also use the remote control to operate the device.*

BASIC OPERATIONS

General Settings

For the Home screen, tap **Input** to open the **General Setting** menu. The **General Setting** menu consists of 2 pages.

To switch to the second page, tap ●●● on the top right of the main page.

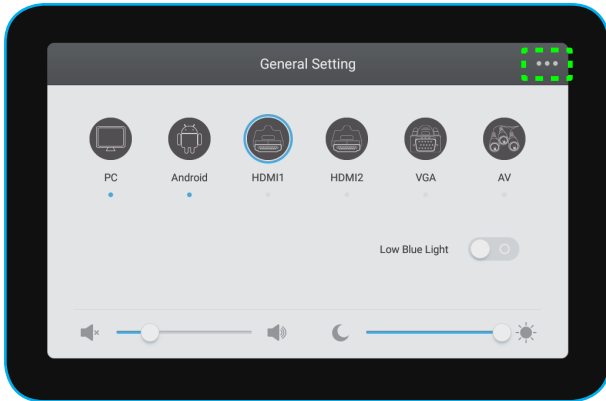

Main Page

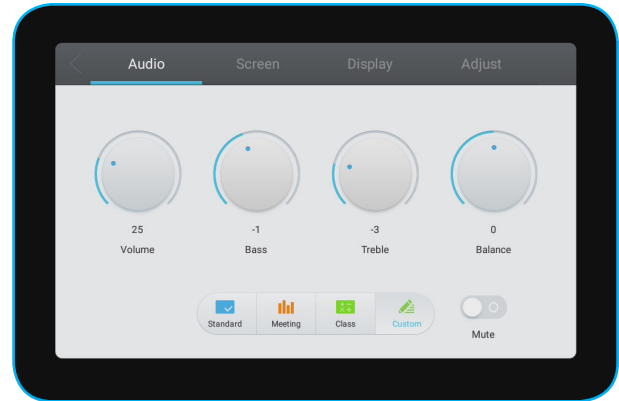

Second Page

Note: You can also access the **General Setting** menu regardless of what page you are on. Simply drag the bottom of the screen upwards.

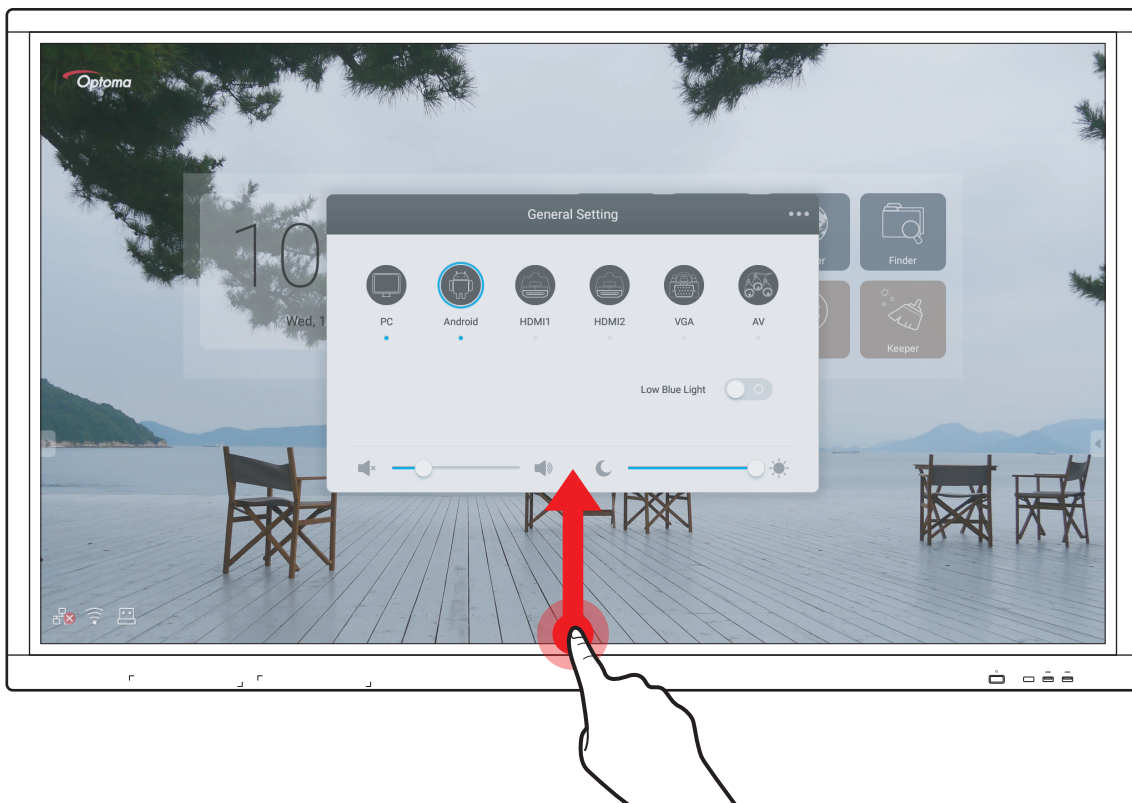

BASIC OPERATIONS

Selecting an Input Source

On the **General Setting** main page, the available the input source is indicated by the ● icon. To change the input source, simply tap the desired input source.

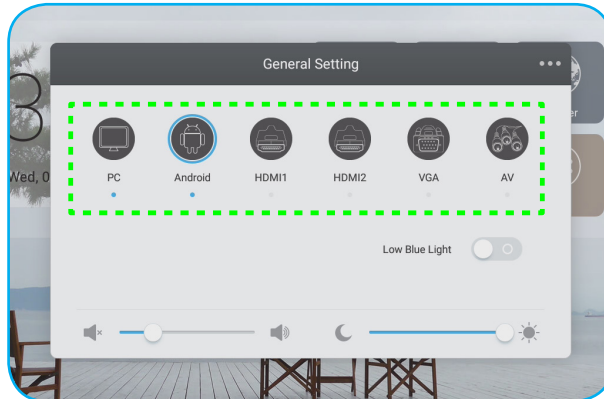

Note:

- For more information about the device connections, refer to the “Making Connection” section.
- The PC option is only available if the PC module is properly installed into the OPS slot of the device.

Activating the Low Blue Light Function

IMPORTANT! Studies have shown that just as the ultra-violet rays can cause eye damage, the shortwave-length blue light rays from the displays can cause eyestrain, retina damage, and affect vision over time. Optoma Low Blue Light is an eye protection feature that can reduce the blue light.

On the **General Setting** main page, slide the **Low Blue Light** switch to the right to enable the function.

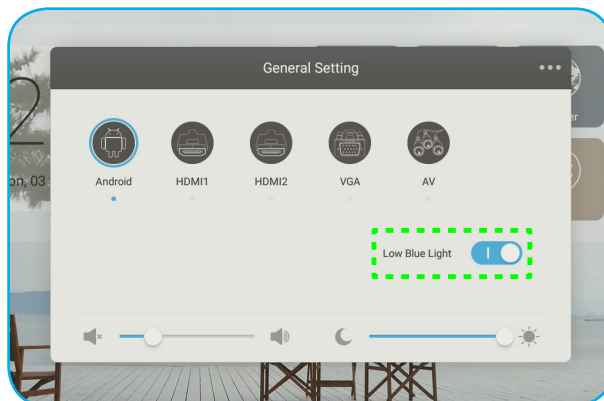

Note: For protecting your eyes against prolonged display use, we highly recommend you to do the following:

- Letting your eyes idle for 10 minutes after 2 hours continuous use.
- Roll your eyes upward towards your eyebrows, and then roll your eyes in a large circle every few hours.
- For every 20 minutes of display viewing, look into the distance for 20 seconds.
- When your eyes get sore, close your eyes for a minute.

BASIC OPERATIONS

Adjusting the Volume Level

On the **General Setting** main page, drag the slider bar to the right/left to adjust the volume level.

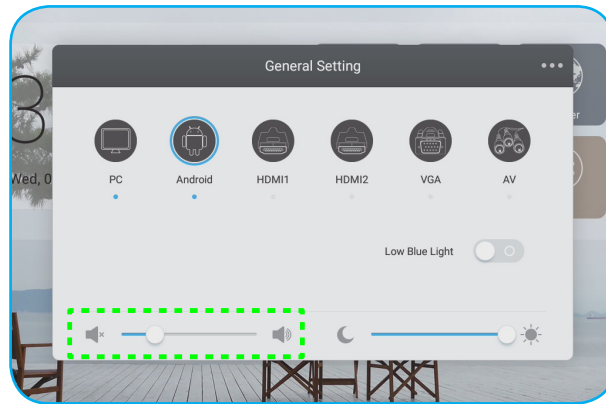

Adjusting the Backlight Level

On the **General Setting** main page, drag the slider bar to the right/left to adjust the backlight level.

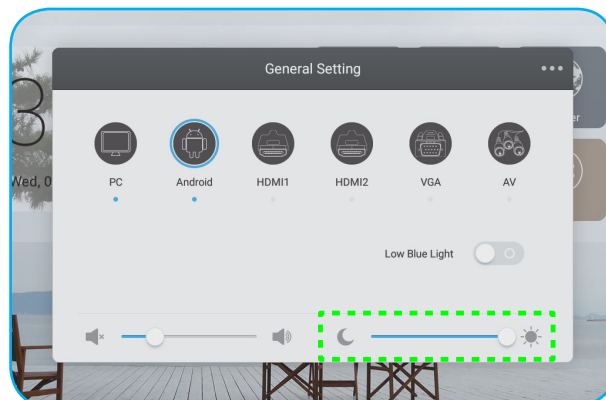

BASIC OPERATIONS

Configuring the Audio Settings

On the **General Setting** second page, select **Audio** to configure the audio settings. Then complete the following steps:

- Select the desired sound mode from one of the available options: Standard, Meeting, Class, or Custom.
Note: If the sound mode setting is set to **Custom**, you can customize the audio settings by adjusting the volume, bass, treble, or balance level according to your preference.
- Slide the **Mute** switch to the right to enable the mute function.

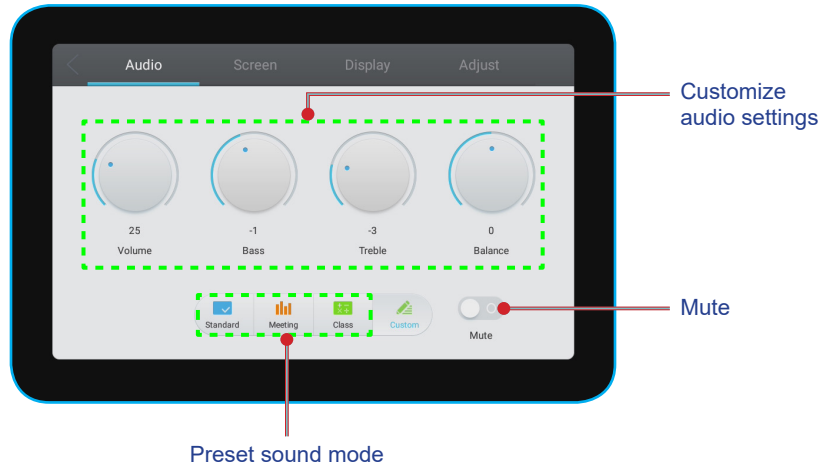

Configuring the Screen Settings

On the **General Setting** second page, select **Screen** to configure the screen settings. Then complete the following steps:

- Select the desired aspect ratio from one of the available options: 4:3, 16:9, or PTP.
- Slide the **Pixel Shift** switch to the right to enable the pixel shift function.
Note: When the function is enabled, it helps to prevent image retention.



BASIC OPERATIONS

Configuring the Display Settings

On the **General Setting** second page, select **Display** to configure the display settings. Then complete the following steps:

- Select the desired display mode from one of the available options: Standard, Bright, Soft, or Custom.
Note: If the display mode setting is set to **Custom**, you can customize the display settings by adjusting the brightness, contrast, hue (available for AV input only), or sharpness (available for AV input only) level according to your preference.
- Select the desired color temperature from one of the available options: Standard, Cold, or Warm.

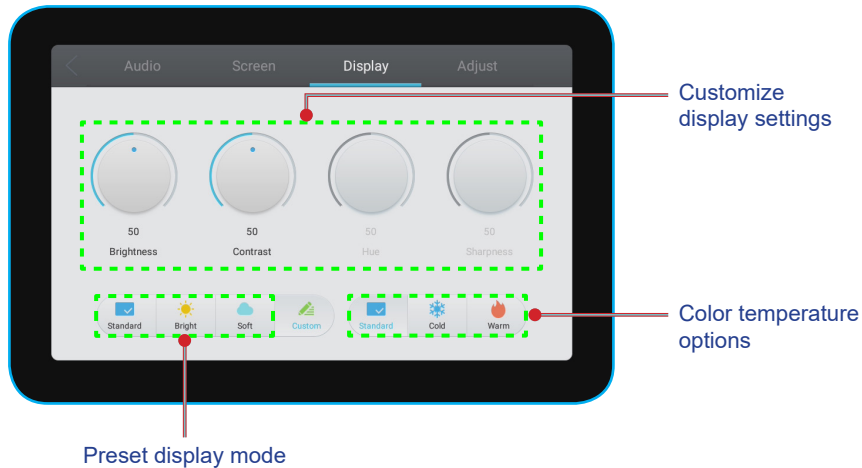

Configure the Adjust Settings (for VGA input only)

On the **General Setting** second page, select **Adjust** to configure the screen settings for the VGA input source. Then complete the following steps:

- Select **H Position** or **V Position** to adjust the horizontal position and the vertical position of the image.
- Select **Clock** to adjust the vertical noise of the image.
- Select **Phase** to adjust the horizontal noise of the image.
- Select **Auto** to automatically adjust the image to its optimized position, clock, and phase.

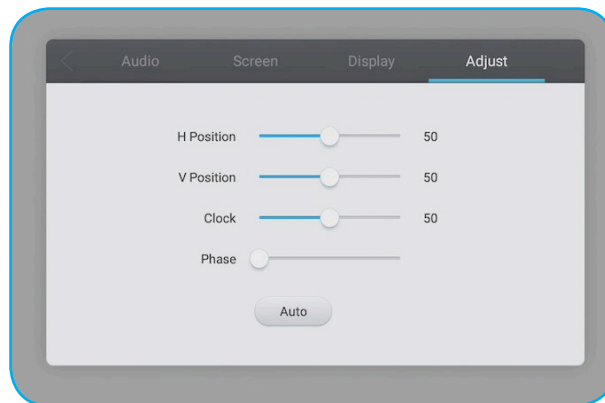





BASIC OPERATIONS

Side Toolbar

Tap  or  to open the side toolbar. You can drag the panel to change its position on the screen.





Side toolbar

- To hide the toolbar, tap .
- To return to the previous screen, tap .
- To return to the Home screen, tap .
- To access the **General Setting** menu, tap .

Viewing the Recent Tasks

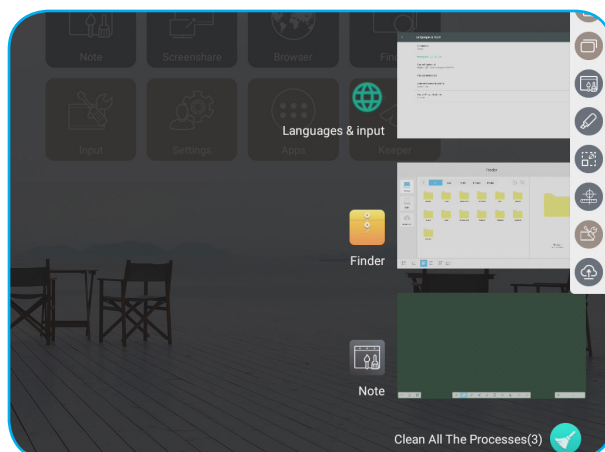
Tap  to view all of your recently used apps.



- Tap on the app you want to launch.
- To remove the app from the list, swipe it left or right.
- To clear the list, tap .





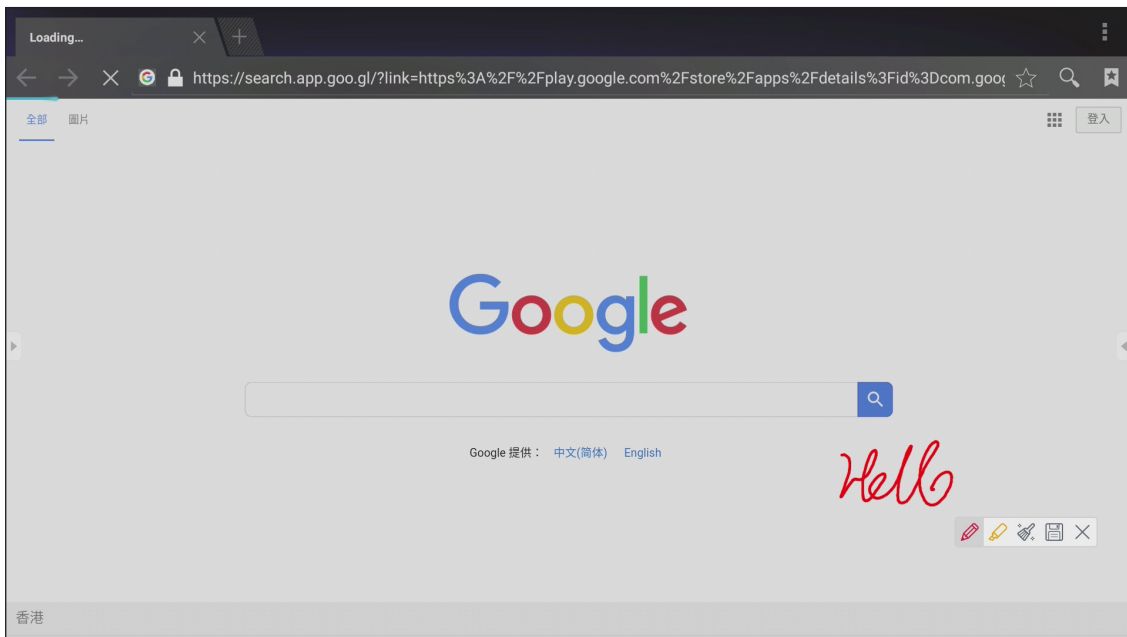

BASIC OPERATIONS

Annotations Tool

Tap  to open the annotation tool.



In this mode, you can do the following:

- Tap  to write and draw on the screen.
Note: You can change the pen color by tapping  repeatedly.
- Tap  to highlight the item on the screen.
Note: You can change the highlighter color by tapping  repeatedly.
- To erase all annotations on the screen, tap .
Note: You can also use the palm of your hand to erase the areas of your written texts or drawings.
- To capture a screenshot of the entire screen, tap .
- To exit the current mode, tap .



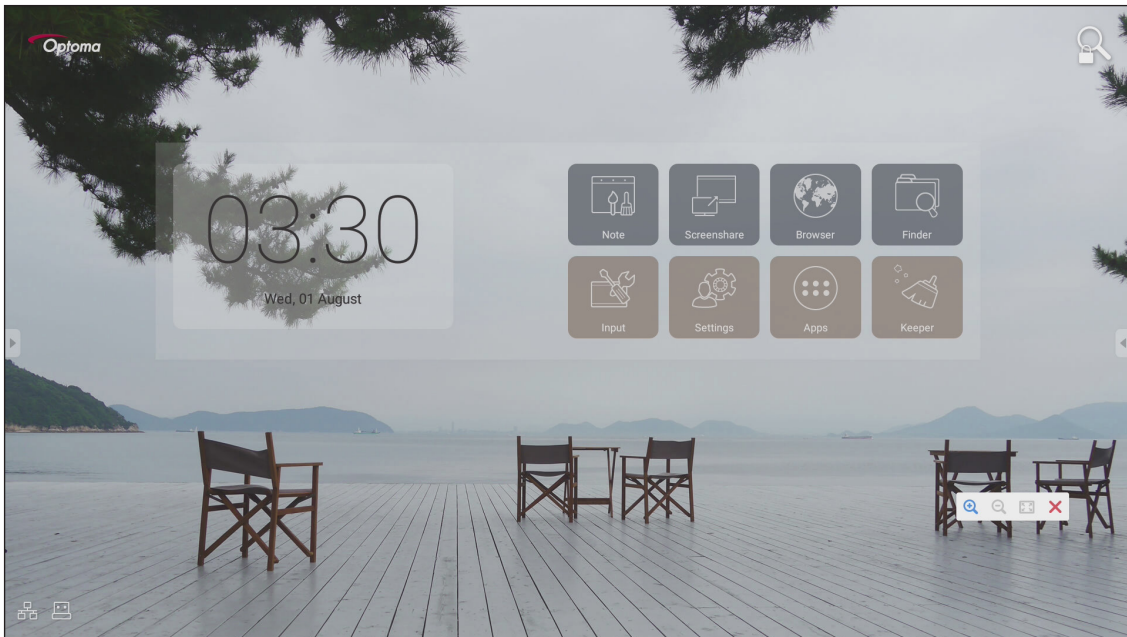

BASIC OPERATIONS

Screen Freezing

Tap  to freeze the current screen.



In this mode, you can do the following:



- To zoom in, tap . Then you can pan and move around the image.
Note: *Each tap increases the magnification.*
- To zoom out, tap .
- To restore the image to its original size, tap .
- To exit the current mode, tap .

BASIC OPERATIONS

Other Utilities

Tap  to access other utilities such as Spotlight, Countdown, Stopwatch, and AirShare.



- Tap  to activate the spotlight function. The spotlight can be used to direct the audience's focus to a specific part of the board.
- Tap  to use the countdown function.
- Tap  to use the stopwatch function.

AirShare

Tap  to enter AirShare. A QR code appears on the screen.



To join the virtual classroom, complete the following steps:

1. Connect the device to an available network.
2. On your mobile device, enable the Wi-Fi function. Then connect to the same network as the device.

IMPORTANT!

- *The device and your mobile device must be connected to the same Wi-Fi network.*
- *During the operation, make sure that you have access to the internet.*

BASIC OPERATIONS

3. Scan the QR code. Then enter your name and tap **Enter** to join the class.

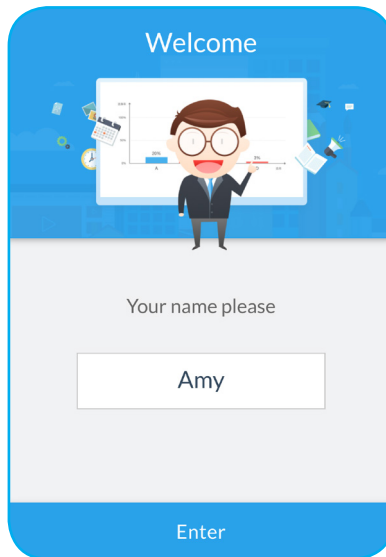

4. On the device, tap **ENTER THE CLASS** to start the class session.

To participate in the class, do the following:

Launch the **Note** app to open virtual blackboard. Then you can use the following functions:

a. Voter

1. Tap  to enter the Voter interface.
2. Select **Single choice** or **Multiple choice** to define the answer type.

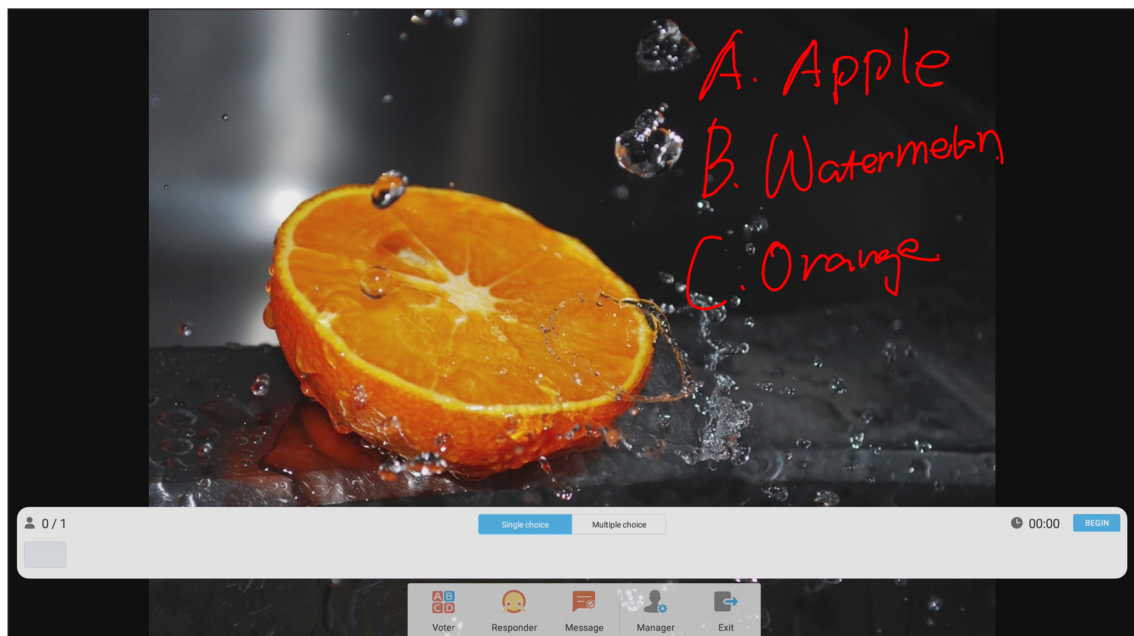

BASIC OPERATIONS

3. Tap **BEGIN** to start answering question.

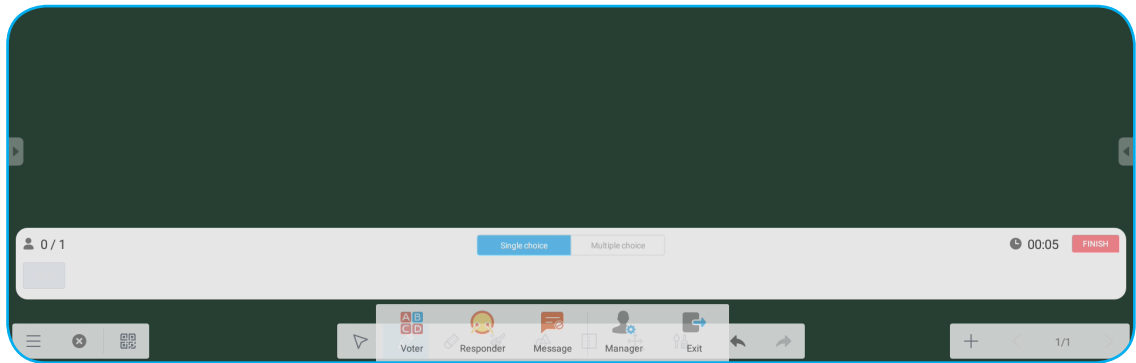

4. The participant can respond by selecting the answer on the mobile device screen and tap **OK**.

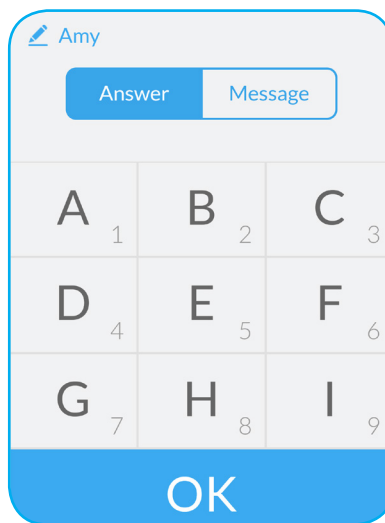

5. To close the answering session, tap **FINISH**. The Answer statistics will be displayed on the screen.

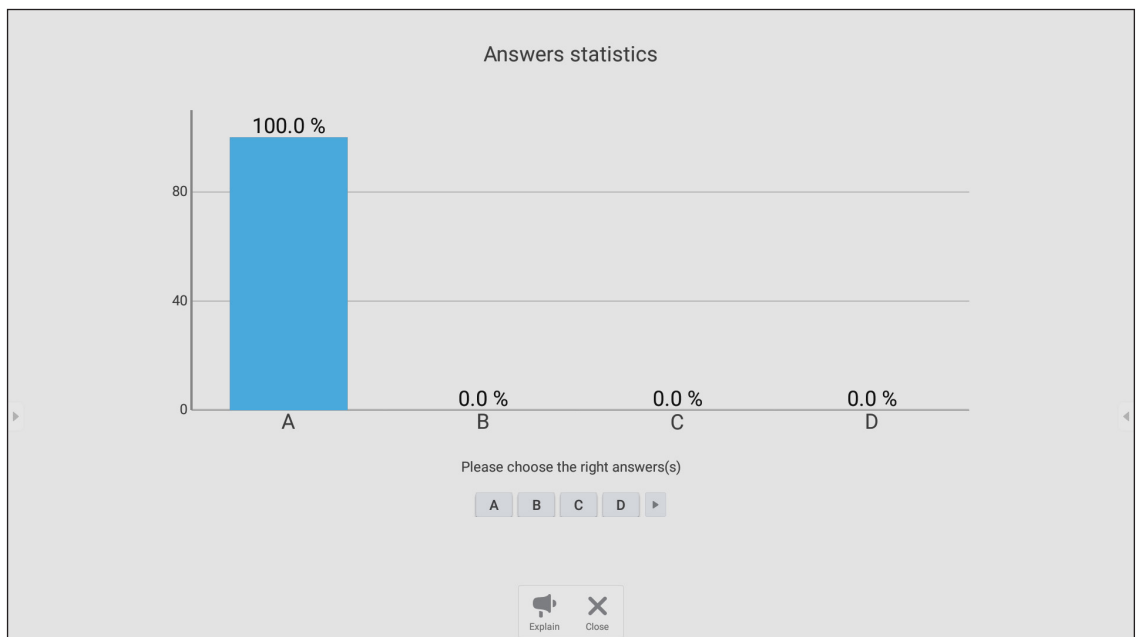

- Tap to switch to the explanation session. Then the instructor can explain to the participant(s) the solution for the question.
- Tap to close the Answer statistics page.

BASIC OPERATIONS

b. Responder

1. Tap 🗨️ to enter the Responder mode. Then tap **GO!** to start the Answer mode.

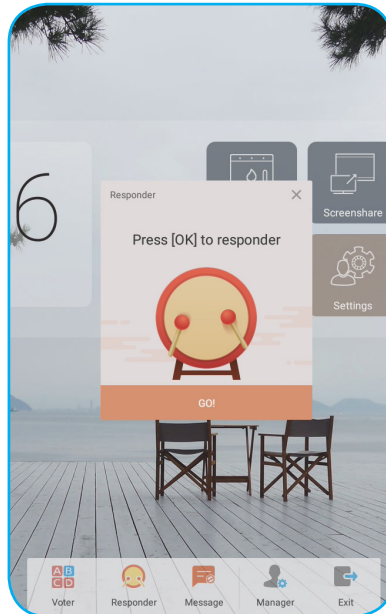

2. When the function is activated, the person who taps **OK** first will get the right to answer. For example, if Sawyer first taps **OK**, then he gets the right to answer the question.

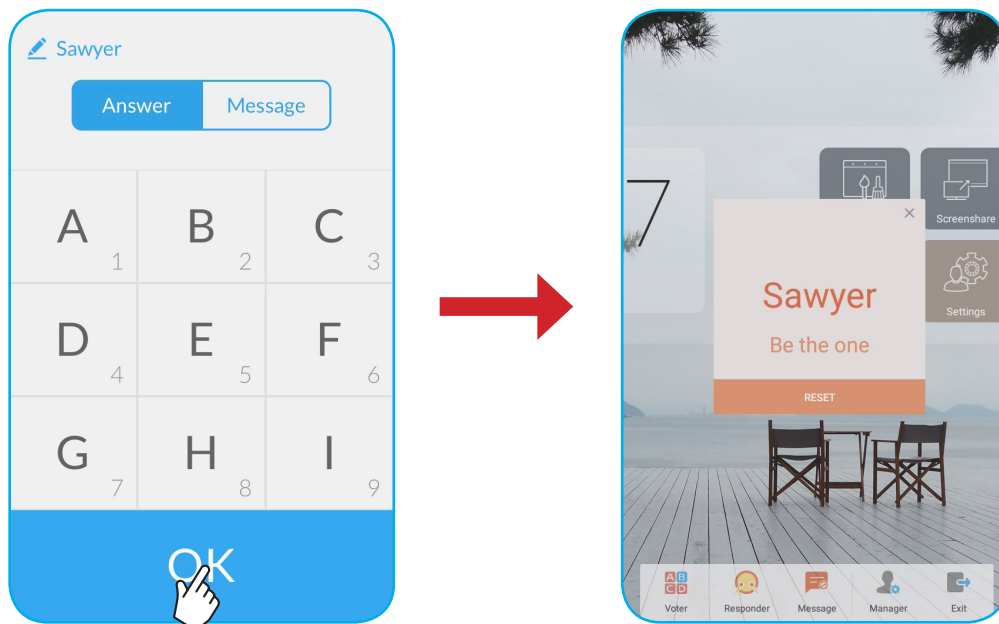

BASIC OPERATIONS

c. Message



1. Tap  to enable the message function. By default, this function is disabled.
2. On the mobile device, tap **Message** to switch to the Message screen. Then enter your message in the comment text box and tap **Send**.

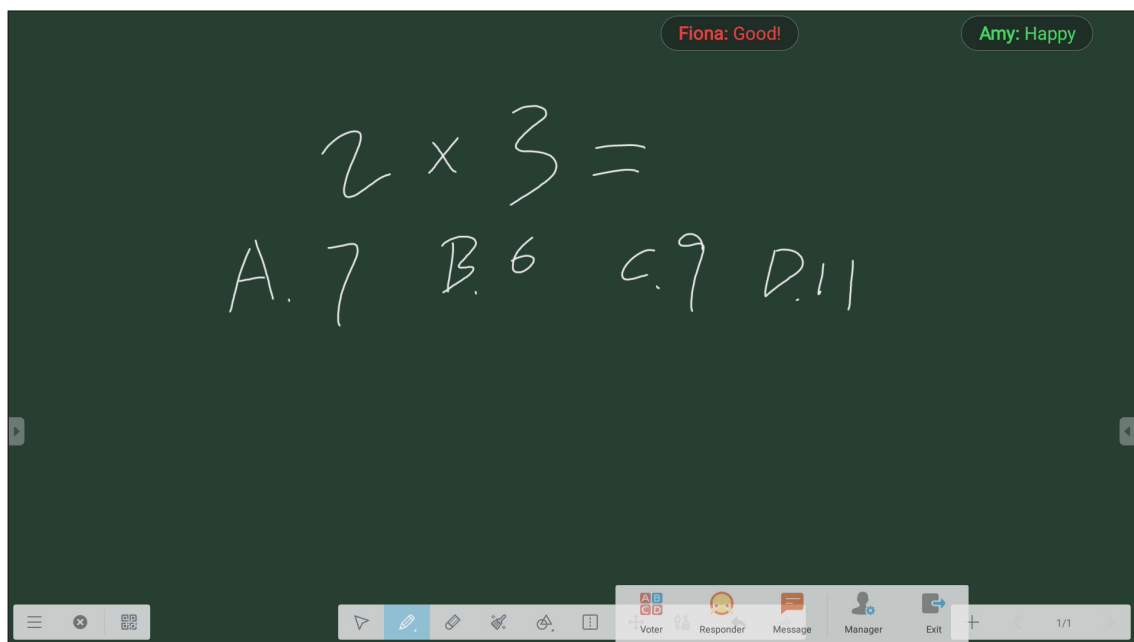

The broadcast message will appear on the device screen.



Note:

- Tap  to display the QR code and allow more participants to join the class.
- Tap  to exit AirShare.

BASIC OPERATIONS

Cloud Drive

Tap  to create an account to access the Cloud Drive.

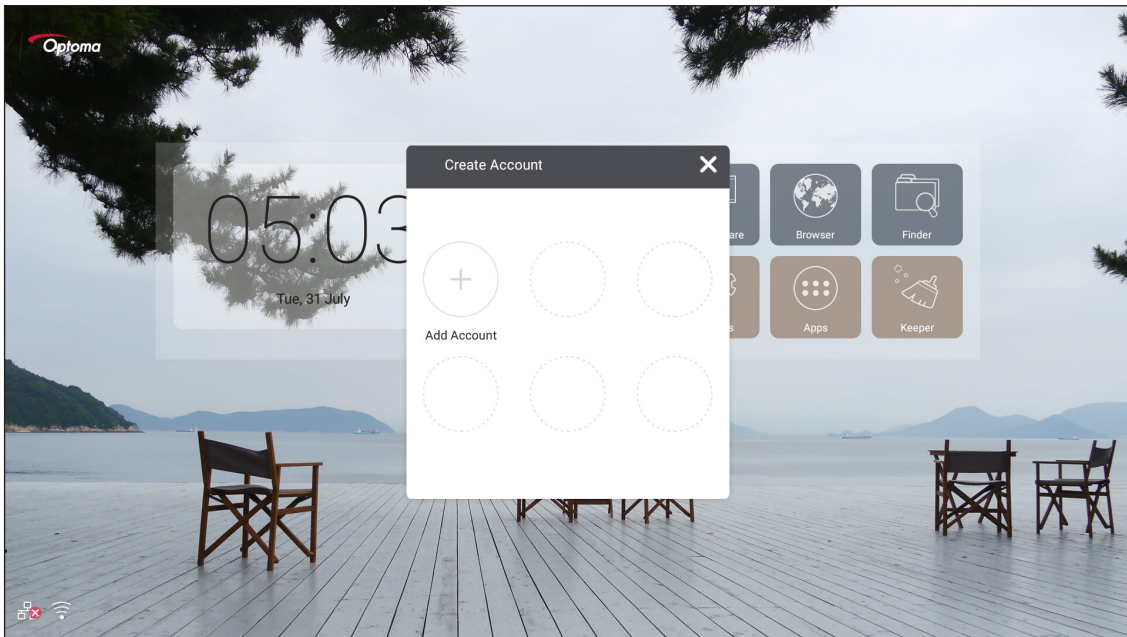

To create an account:

1. Tap **Add Account**.
2. Select the drive type.

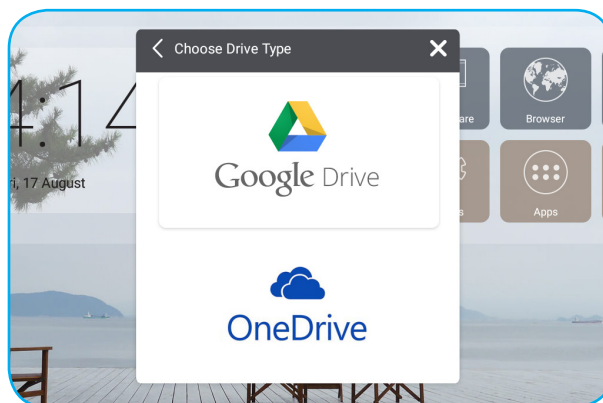

3. Follow the on-screen instructions to create an account or sign in to your existing account. Your account will appear in the list after successful login.

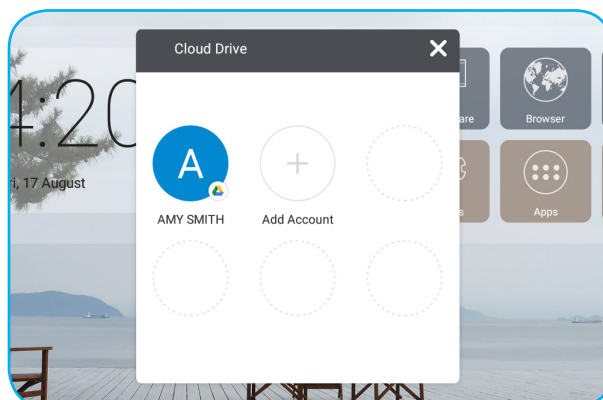

Note: To protect your personal data, you will be logged out automatically from Google Drive/OneDrive when the device is turned off.

BASIC OPERATIONS

Advanced Settings

For the Home screen, tap **Settings** to open the **Settings** menu.

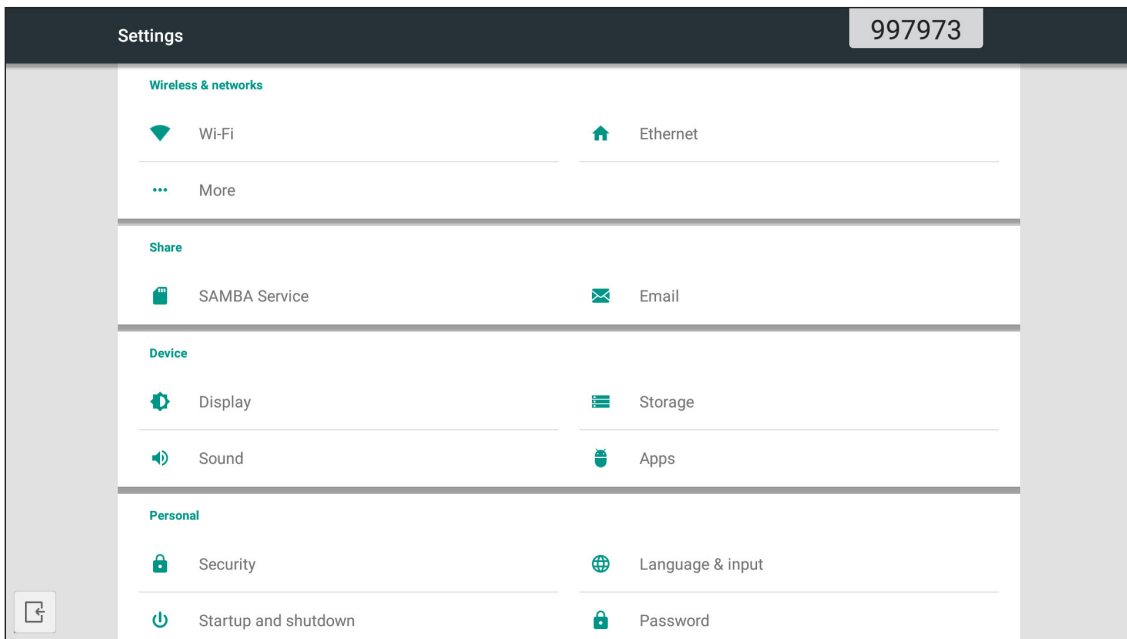

Category	Options	Description
Wireless & Network	Wi-Fi	Configure the wireless network settings.
	Ethernet	Configure the wired network settings.
	More	Access more functions.
Share	SAMBA	Enable/Disable the SAMBA service. When enabled, you can share the folders in IFPs to other devices under the same network. To download data in IFPs to PCs, you have to establish a connection through the IP address. Then you can set a password for the account for security.
	Email	Configure the SMTP mail server settings.
Device	Display	Set the wallpaper and execute the pixel shift function.
	Storage	View the total space/free space of the device/portable storage.
	Sound	Turn on or off the touch sound.
	Apps	View the memory usage, permissions, and other information for each app.
Personal	Security	Access the advanced security settings and set the third party apps installation authority.
	Language & input	Set the on-screen display language and configure other input options.
	Startup and shutdown	Configure the Startup channel, Standby after startup, and set schedule timer to turn on/off the device regularly.
	Password	Set or change screen lock password.
	Input Setting	Change the name of input sources.
	Other Settings	Configure the side toolbar channel and Note writing settings.
System	Date & Time	Configure the date and time settings.
	About device	View the system information.

Note: Tap  to exit the **Settings** menu.

BASIC OPERATIONS

Configuring the Network Settings

Wireless network

IMPORTANT! To connect to a wireless network, make sure the Wi-Fi dongle is properly plugged into one of the rear USB ports.

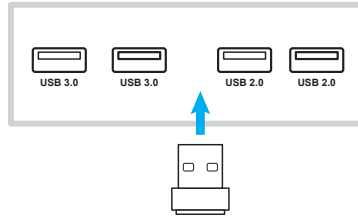

1. From the Home screen, select **Settings** → **Wi-Fi**. Then slide the **Wi-Fi** switch to right to enable the Wi-Fi function.



2. Select one of the available network and tap **CONNECT**.

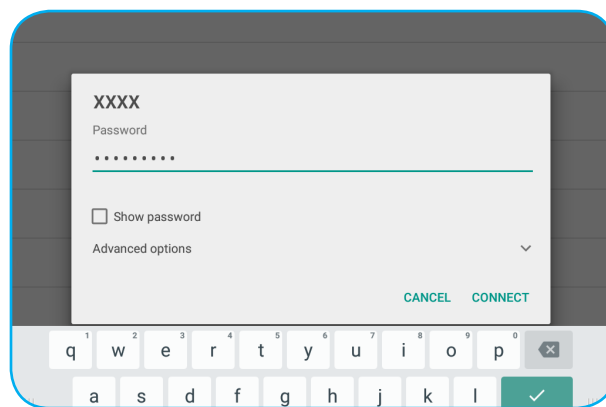

Note: If you connect to a secure network, you have to enter the password at first-time connection only.

BASIC OPERATIONS

Wired network

1. Connect one end of the Ethernet cable to the LAN port of the device.
2. Connect the other end of the Ethernet cable to the router.



3. From the Home screen, select **Settings** → **Ethernet**. Then slide the **Ethernet** switch to right to enable the wired network function.
4. Configure the necessary network settings.
 - Select the **DHCP** checkbox to allow the device to obtain an IP address automatically from your network.
 - Select the **Static IP** checkbox to configure the IP address, gateway, netmask, DNS, and proxy parameters manually.

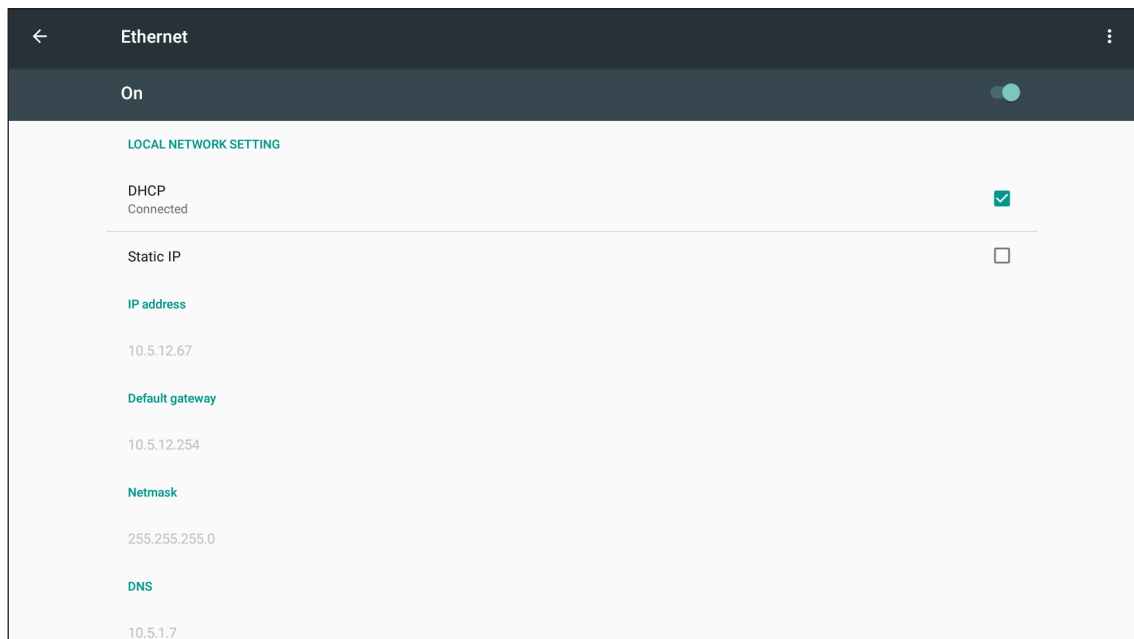

USING THE APPS

From the Home screen, tap **Apps** to view the Apps list.

IMPORTANT! *The embedded Android 7.0 operation system is not standard Android. As such, Google Play is not available in the Apps list. The installed third party application might not work properly if it is not designed for IFP. Optoma will not guarantee that these self-installed Apps can work.*

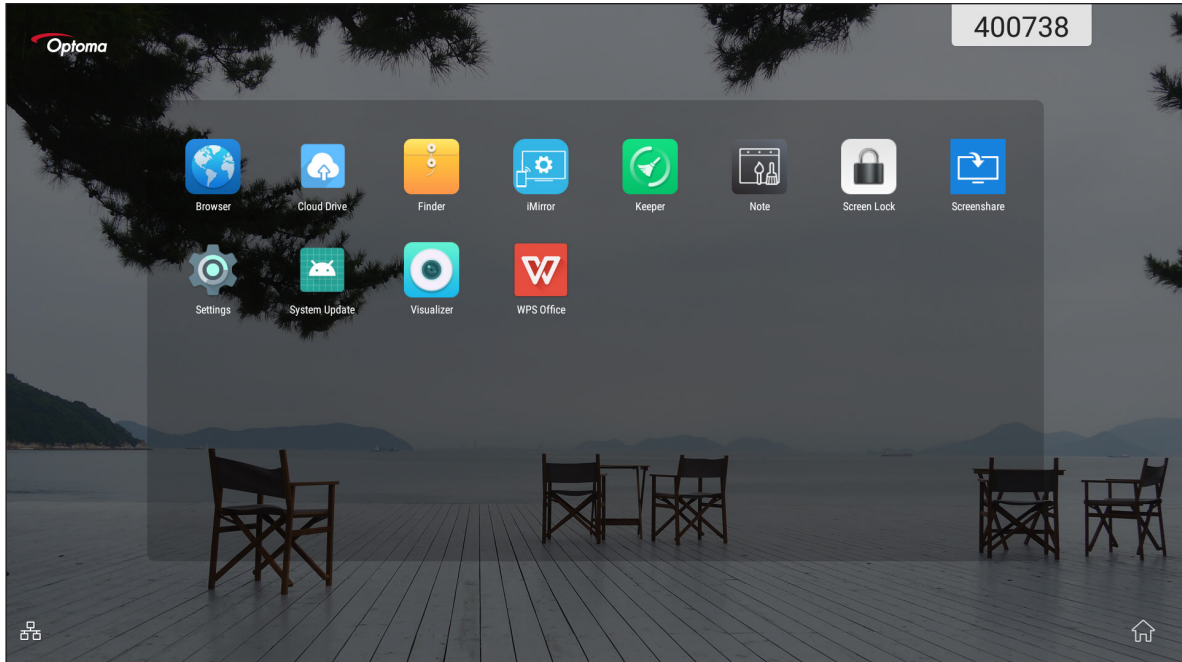

Note: *To install a third party application, you have to enable the Unknown sources setting (Settings → Security → Unknown sources) first.*

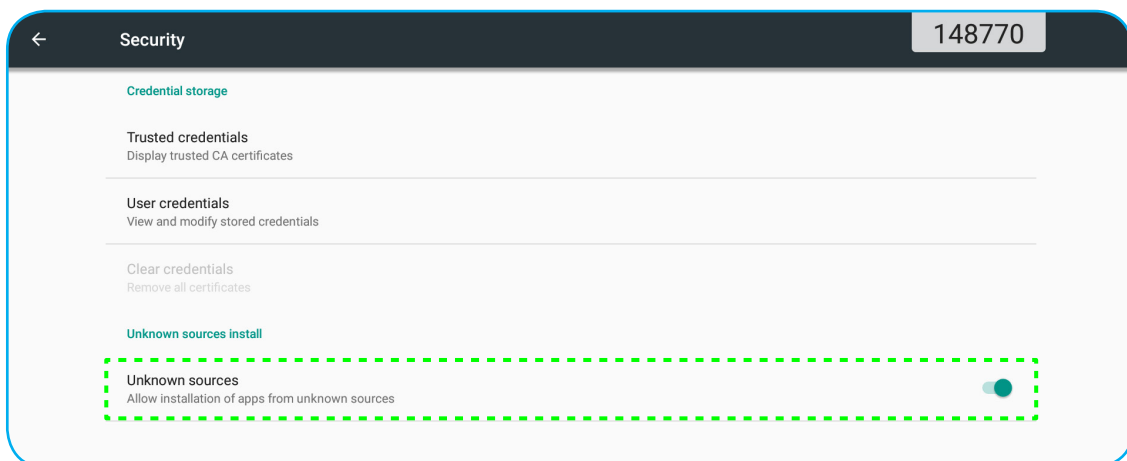





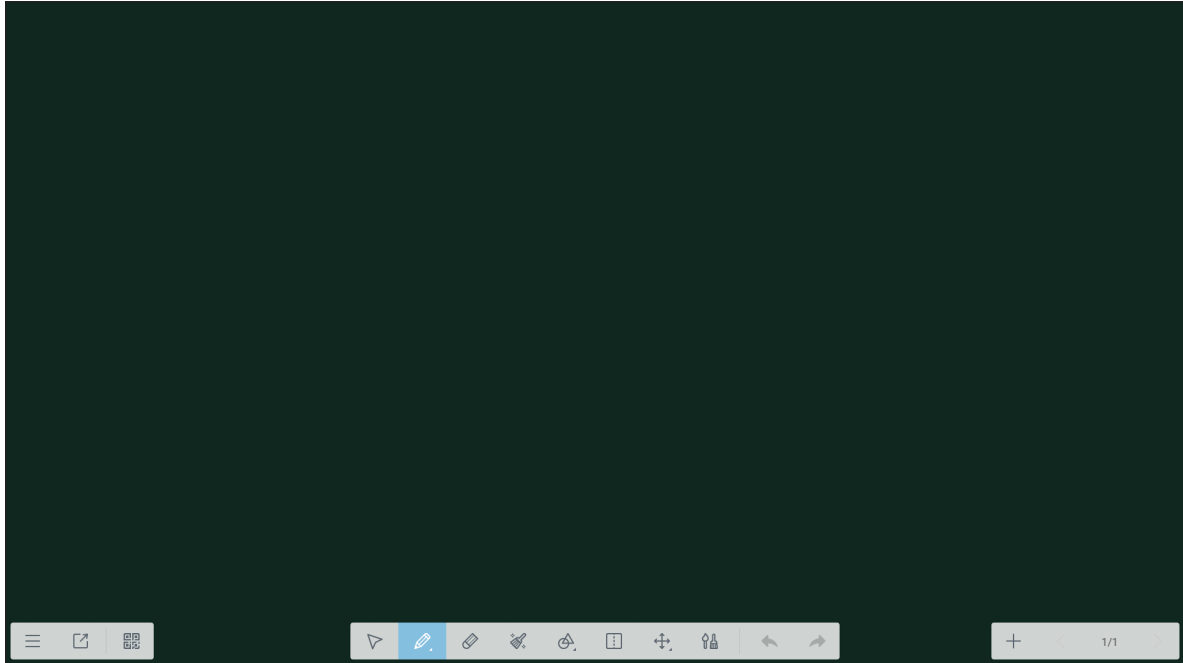

Then you can install the downloaded APK (Android Package) file into your system.

USING THE APPS



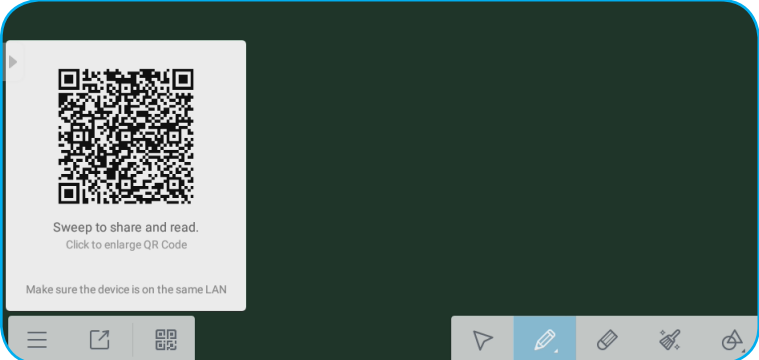

Note

With **Note** app, you can write, scribble, or draw on the virtual blackboard.



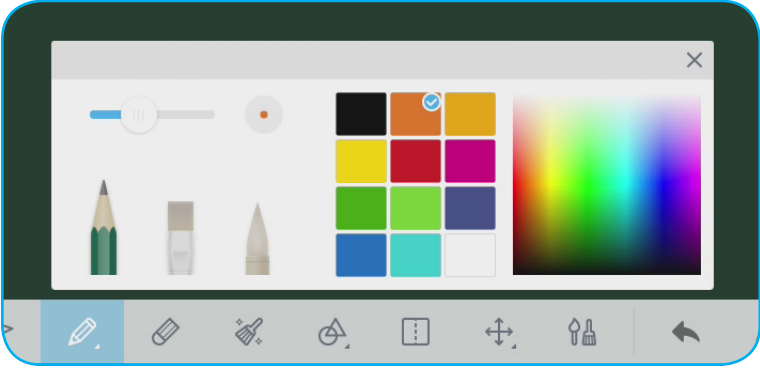

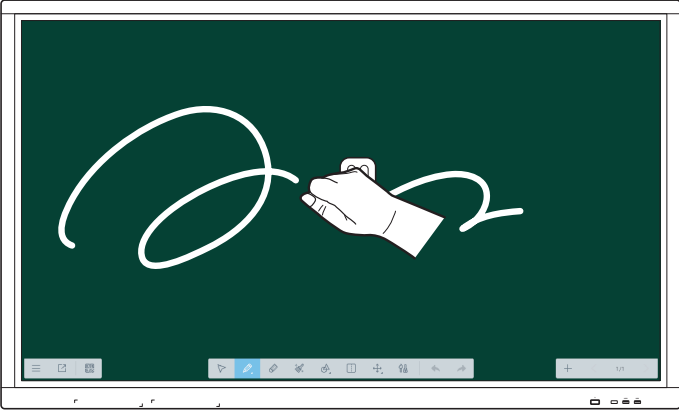
Item		Description
	Menu	Display more options. For details, refer to the “Advanced Options” section.
	Exit	Exit the Note app.
	QR code	<p>Export the file and create a QR code.</p>  <p>Note: Before scanning the QR code to view the file, make sure the device and your mobile device are connected to the same Wi-Fi network.</p>
	Select	Select any object on the blackboard.

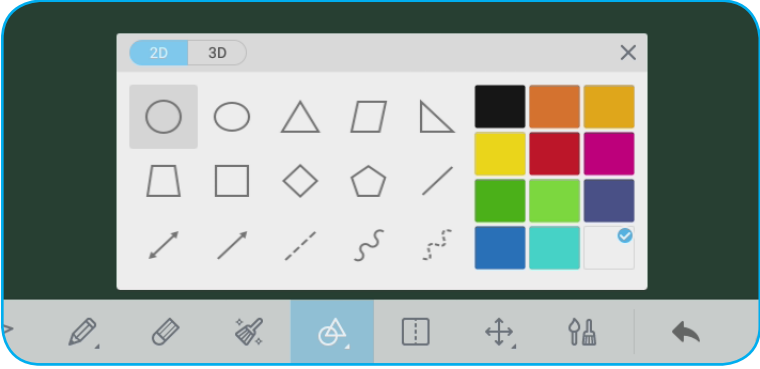

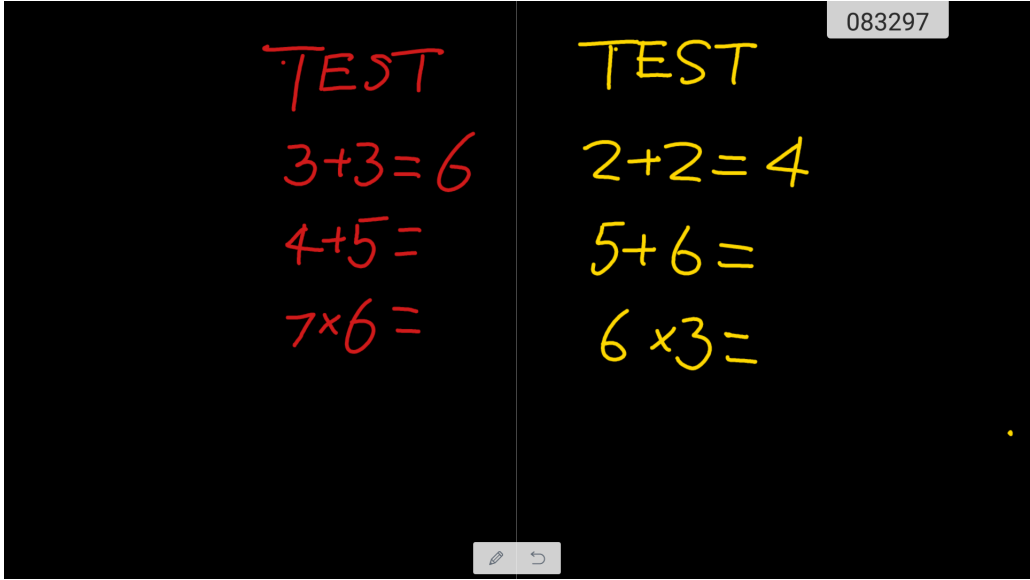

USING THE APPS

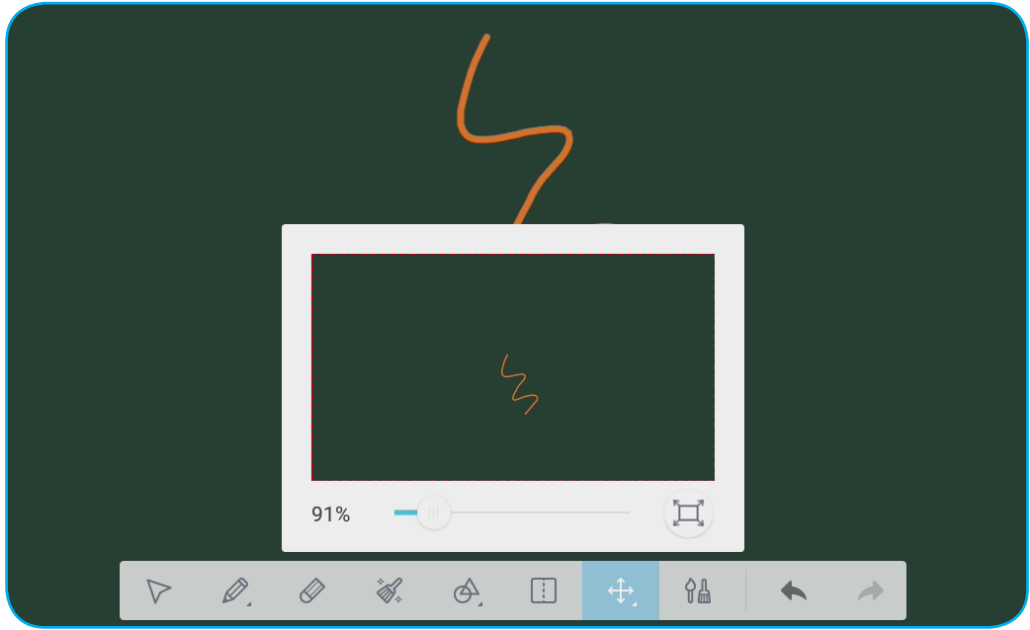
Item	Description
 Pen	<p>Write or draw a freeform line. Tap to select the desired pen type and configure the line style, including its thickness and color.</p> 
 Eraser	<p>Erase the areas of your written texts or drawings. Select by drawing a circle around the area you want to erase.</p> <p>Note: You can also use the palm of your hand to erase the item on the blackboard.</p> 
 Erase All	<p>Erase all written texts or drawings on the virtual blackboard.</p>
 Geometric shape	<p>Draw a geometric shape. Tap to select the desired 2D or 3D shape with several color options.</p> 

USING THE APPS

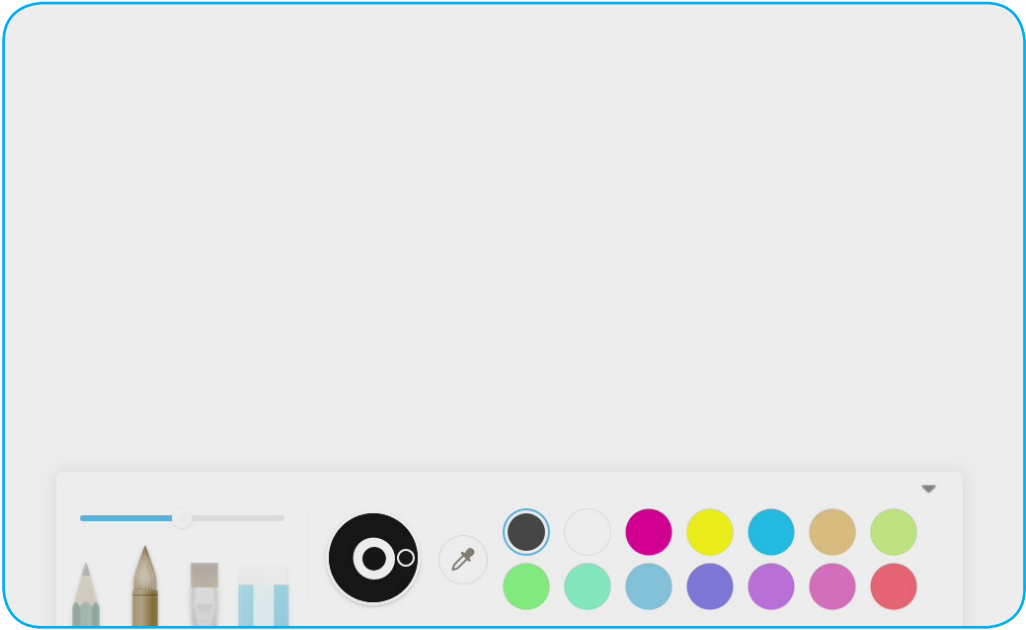
Item	Description
 Split screen	<p>Split the screen to two sections.</p> <p>Note: You can set different pen color and thickness to write in each section.</p> 
 Pan and Zoom	<p>Drag to pan and move around the image. Then tap to zoom in or out.</p> 

USING THE APPS

Item		Description
 Painting		<p>Access the painting board. In the painting board, you can change the pen/brush style and its color, and also customize the color settings.</p> 
	Undo	Cancel the last change.
	Redo	Revert the last undo.
	Add page	Add a new page.

USING THE APPS

Advanced Options

Tap  to access more options.

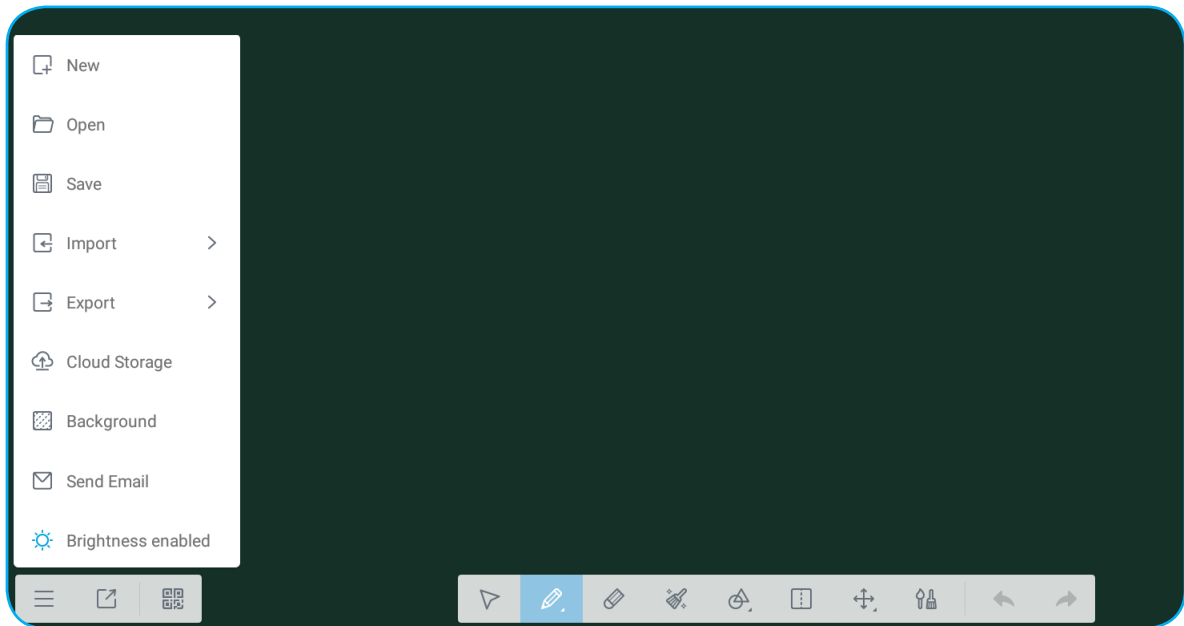

Options	Description
New	Create a new file.
Open	Open the *.enb format file.
Save	Save the current content as an ENB file.
Import	Import a IMG, PDF, or SVG file to the courseware.
Export	Export the current content as an IMG, PDF, SVG, or IWB file.
Cloud Storage	Export and upload the current file to Google Drive or OneDrive.
Background	Change the current board background color and its template.
Send Email	Share the current content via e-mail.
Brightness enabled / Brightness disabled	Enable/disable the automatic brightness adjustment function.

USING THE APPS





Screenshare

Select **Screenshare** to project your mobile device or your computer display to the device through the Wi-Fi connection.

IMPORTANT!

- *The device and your mobile device/computer must be connected to the same Wi-Fi network.*
- *During the operation, make sure that you have access to the internet.*

ShareSender App Compatibility Table

Operating System	Available Version
 Windows	Windows 7/8/10
 Mac	OSX 10.8 or later
 iPhone	IOS 9.0 or later
 Android	Android 5.0 or later
 Chrome Book	Chrome OS 65 or later

Mobile Device

When the setup guideline screen appears, scan the QR code to download and install the **Share Sender (Screenshare)** app into your mobile device.

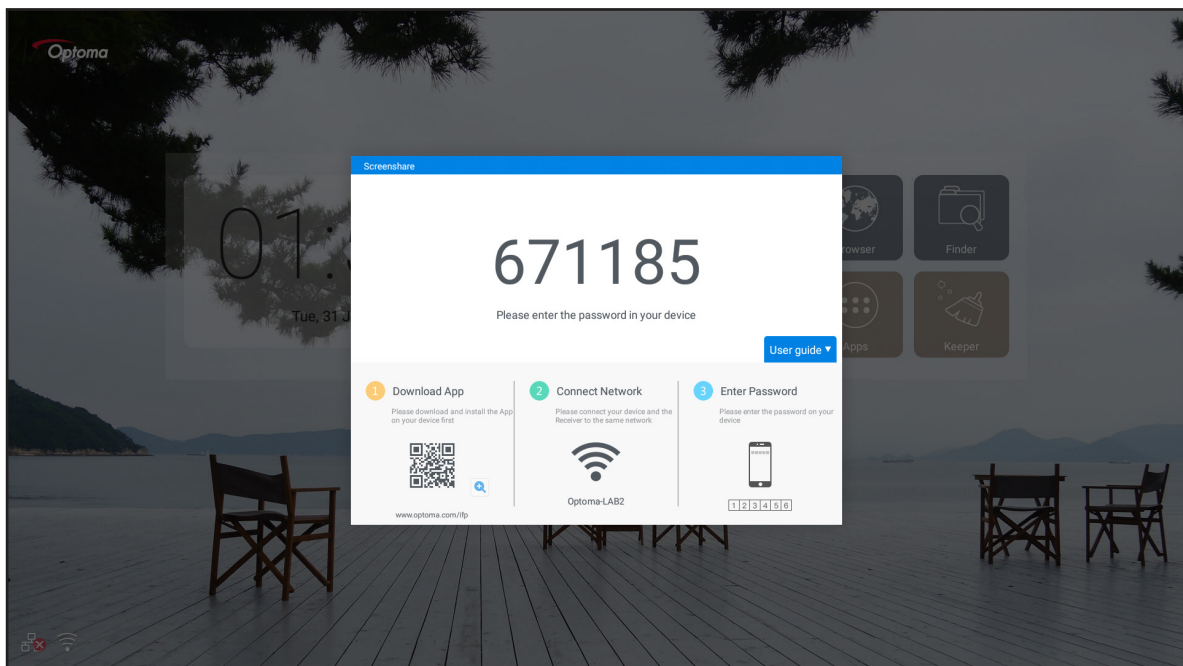

USING THE APPS

To share the screen, complete the following steps:

1. Launch the **Share Sender** app. Then enter the password to establish the connection.

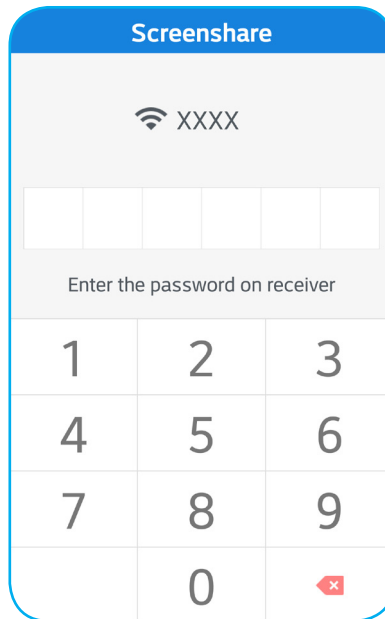

Note: You can obtain the password for the wireless connection setup on the setup guideline screen.

2. Tap **Start**. When a pop-out message appears on the screen, tap **START NOW** to continue.

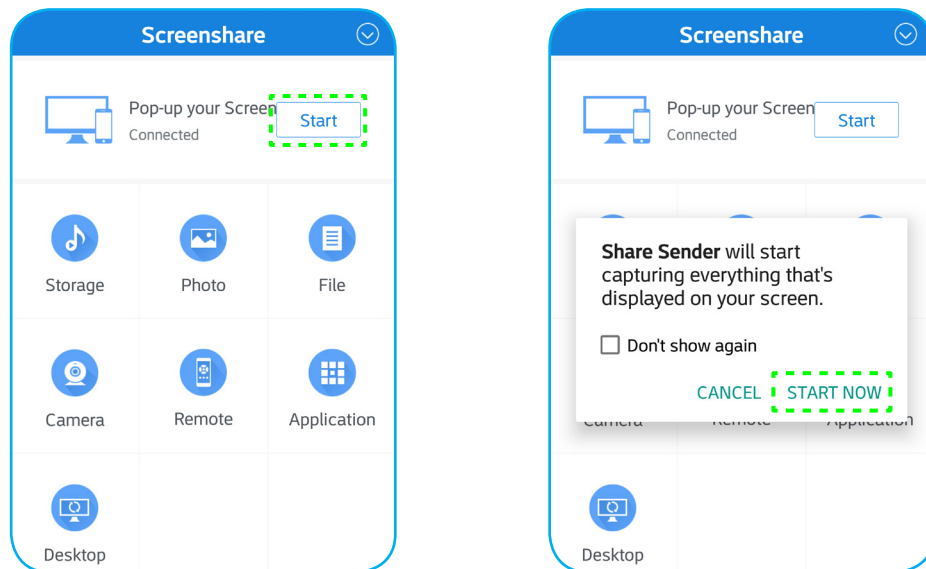

Your mobile device display will be projected automatically on the device screen. To stop sharing the screen, tap **Stop**.

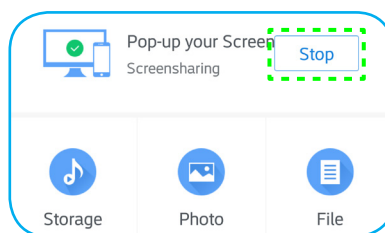

USING THE APPS

The available functions in this app are the following:

Options	Description
Storage	Listen to music stored in your mobile device.
Photo	View the photos stored in your mobile device.
File	View the files stored in your mobile device.
Camera	Turn on the camera of your mobile device and transfer the image captured by the camera to the device.
Remote	Use your mobile device as a remote control to control the device.
Application	Your mobile phone remotely launches the apps installed in the device.
Desktop	Mirror the device screen to your mobile device. You can use your mobile device to operate the device.

Note: To use the available functions in this app, select an option and tap **DISCONNECTED** to continue using the wireless display function.

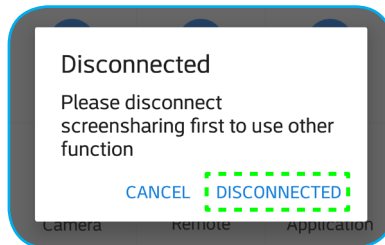

Computer

Go to <https://www.optoma.com/ifp/> to download the **Share Sender** app. Then install the app onto your computer.

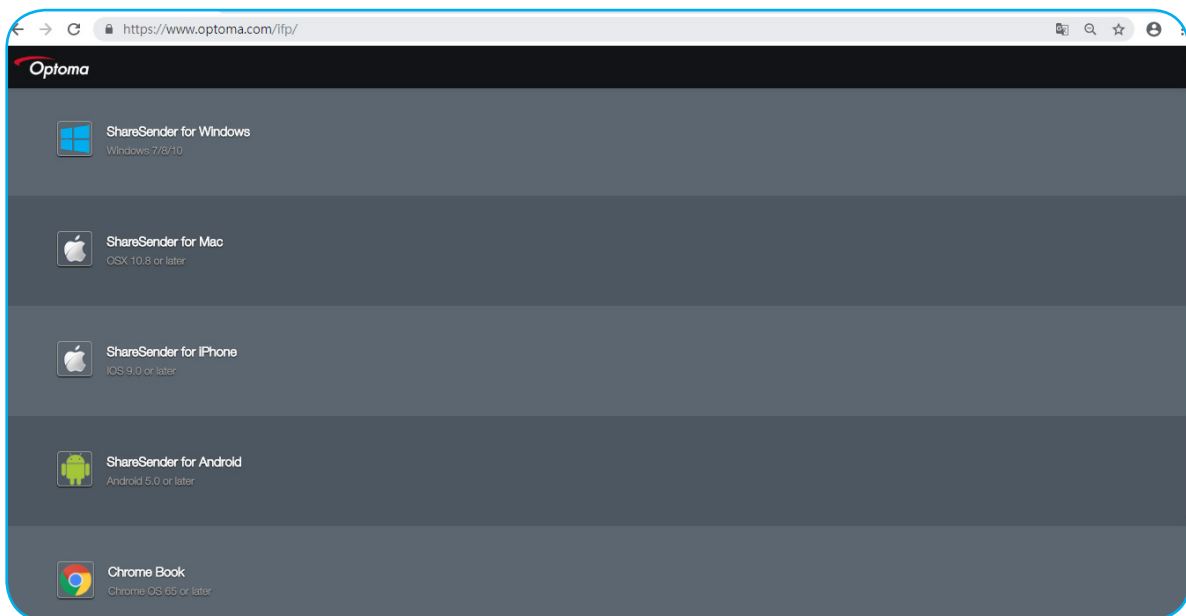

USING THE APPS

To share the screen:

1. Launch the **Share Sender** app. Then enter the password to establish the connection.

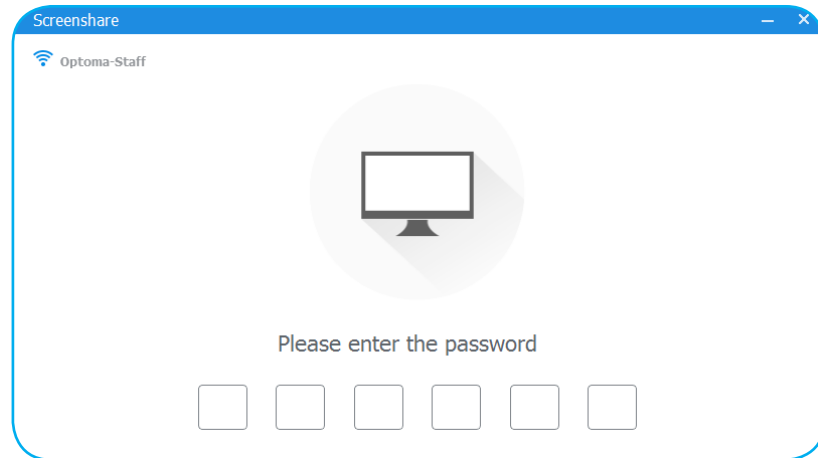

Note: You can obtain the password for the wireless connection setup on the setup guideline screen.

2. Once connected, tap **Share Screen**. Your computer display will be projected automatically on the device screen.

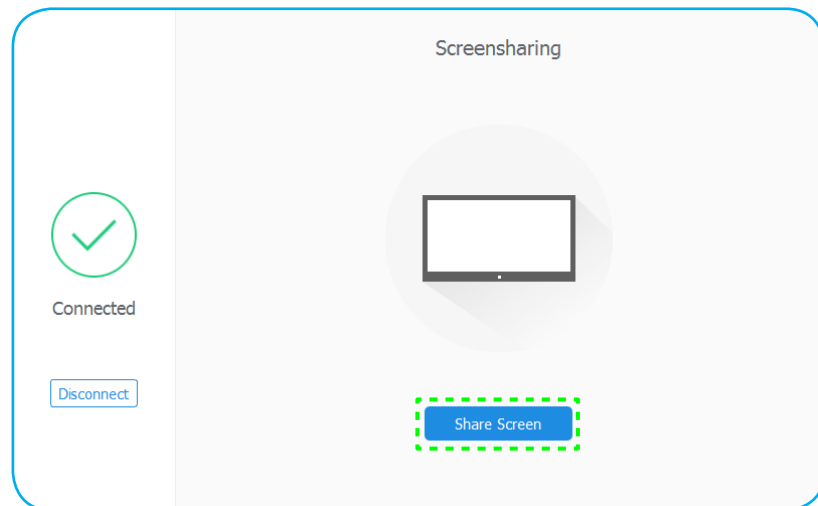

To stop sharing the screen, tap **Stop**.

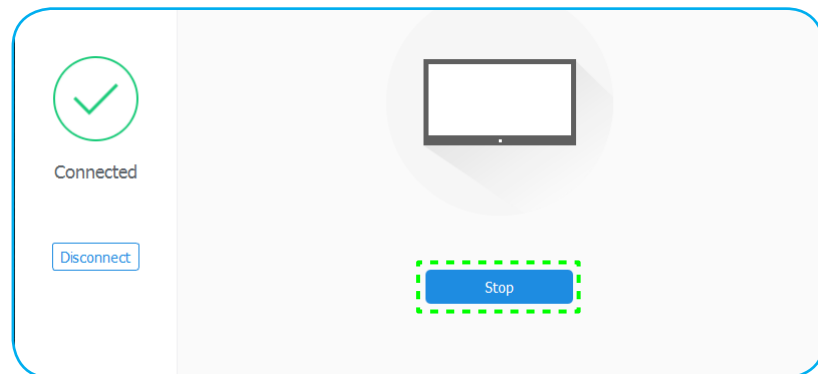

USING THE APPS







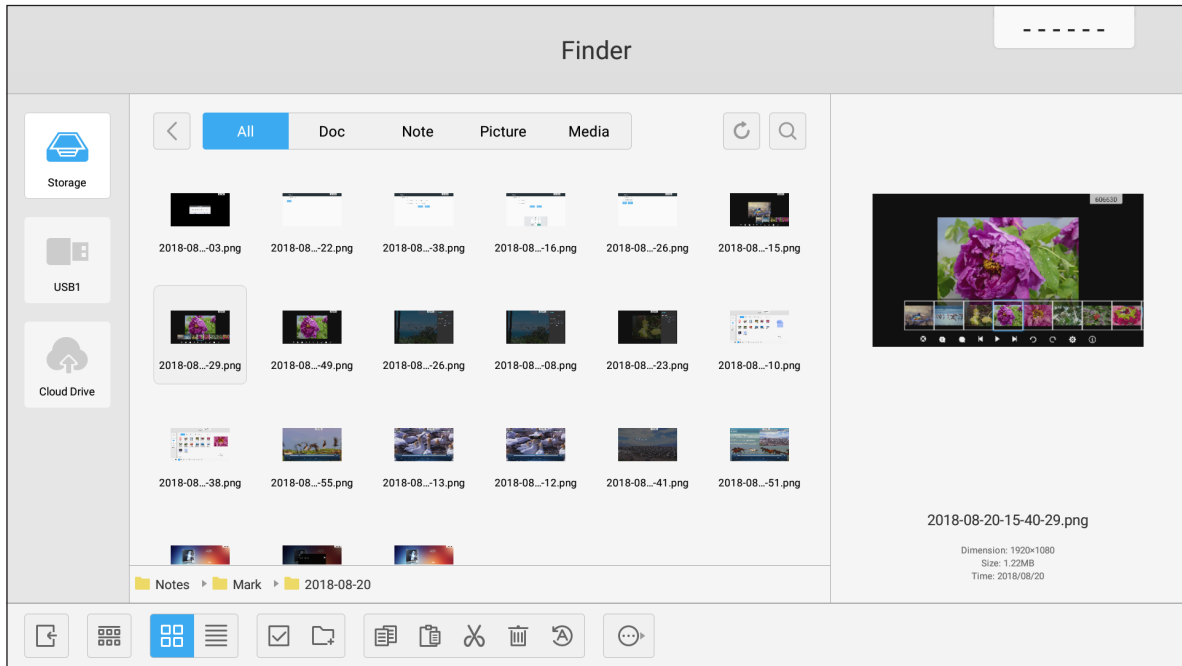





Finder

Select **Finder** to manage the files and applications.

Managing the Files



Browse the file or folder you want to view. Then you can do the following:

Item		Description
	Exit	Exit the Finder app.
	Sort	Select the sorting type.
	Thumbnails	Display the files/folders in Thumbnails view.
	List	Display the files/folders in List view.
	Select	Switch to multiple selection mode.
	New Folder	Create a new folder.
	Copy	Copy the selected item(s).
	Paste	Paste the selected item(s).
	Cut	Cut the selected item(s).
	Delete	Delete the selected item(s).
	Rename	Rename the file/folder.
	Send	Copy the selected item(s) to another storage media.
	Deselect	Deselect the selected item(s).

USING THE APPS

Item	Description
 Select All	Select all selected items.

Note: If you log into Cloud Drive, you can also access the files in your cloud storage [here](#).

Playing Multimedia Files

Multimedia support format

Media Type	Supported Format
Video	<p>Video support format (codec) up to 4K resolution:</p> <ul style="list-style-type: none"> • *.avi (MPEG-1, MPEG-2 MP@HL, MPEG-4 SP@L0-3, ASP@L0-5, H.264, MP, HP@Level 4.1, H263, VP6, MJPEG) • *.ts (MPEG-2 MP@HL, MPEG-4 SP@L0-3, ASP@L0-5, H.264 MP, HP@Level 4.1, VC1 AP, H265) • *.mpg, *.mpeg (MPEG-1, MPEG-2 MP@HL, H.264 MP, HP@Level 4.1) • *.mp4 (MPEG-4 SP@L0-3, ASP@L0-5, H.264 MP, HP@Level 4.1, H265) • *.mov (MPEG-4 SP@L0-3, ASP@L0-5, MJPEG, H.264 MP, HP@Level 4.1, H265) • *.mkv (VP9, H.265) • *.3gp (H.264 MP, HP@Level 4.1, H263, MPEG-4 SP@L0-3, ASP@L0-5)
Audio	<p>Audio support format (codec):</p> <ul style="list-style-type: none"> • *.wma (WMA/WMAPro: 128Kbps~320Kbps, 8KHz~48KHz sampling rate) • *.mp3 (MPEG Layer 3: 32Kbps~320Kbps, 32KHz~48KHz sampling rate) • *.wav (PCM: Max 320Kbps, Max 48kHz sampling rate / ADPCM: 384Kbps, 8KHz ~ 48KHz sampling rate) • *.m4a (ACC: 24kbps ~ 384kbps, 16KHz~48KHz sampling rate) • *.ogg (Vorbis: Max 320Kbps, 8KHz~48KHz sampling rate)
Image	<p>Supported image format (with the maximum resolution):</p> <ul style="list-style-type: none"> • *.png(8k*8k) • *.jpeg(baseline 8k*8k; progressive 4k*4k) • *.bmp(8k*8k) • *.gif(4k*4k)

USING THE APPS

Playing videos

Select the video you want play and tap ▶ to start the playback.

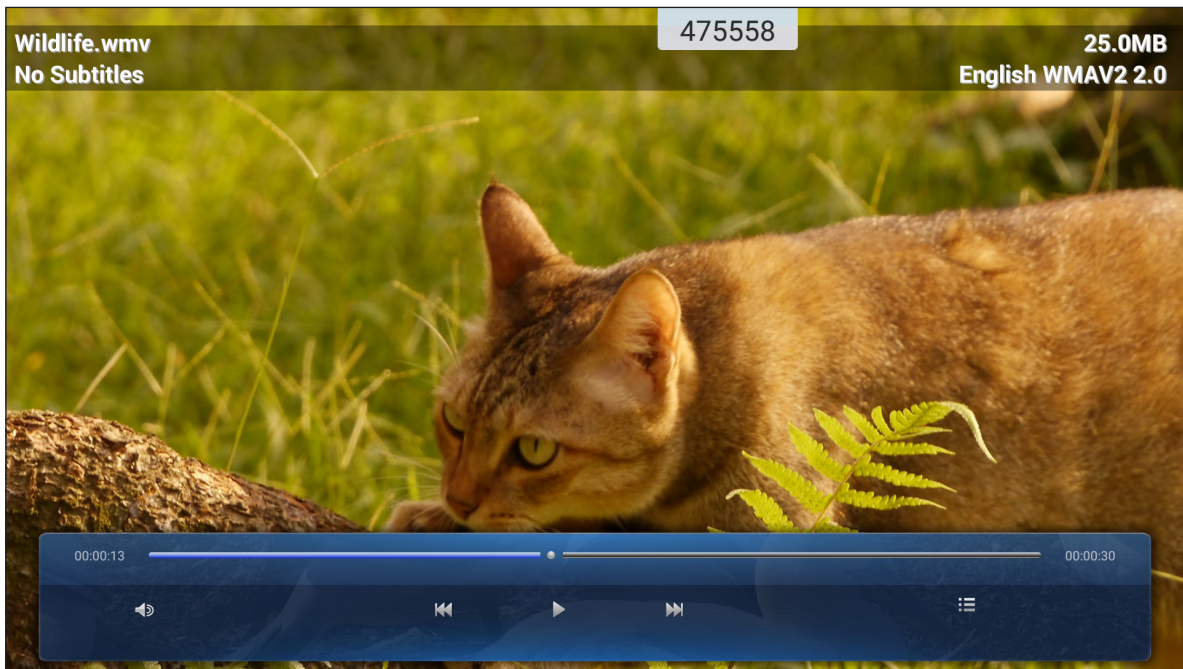

During the playback, you can do the following:

Item	Description
	Volume Adjust the volume level.
	Previous video Skip to the previous video.
	Pause Pause the playback. To resume, tap ▶.
	Next video Skip to the next video.
	View the playlist. To enable multiple playback, select a video from the list. To exit the multiple playback, tap and YES .

Note: To stop playback at any time, tap or to display the side toolbar. Then tap .





USING THE APPS

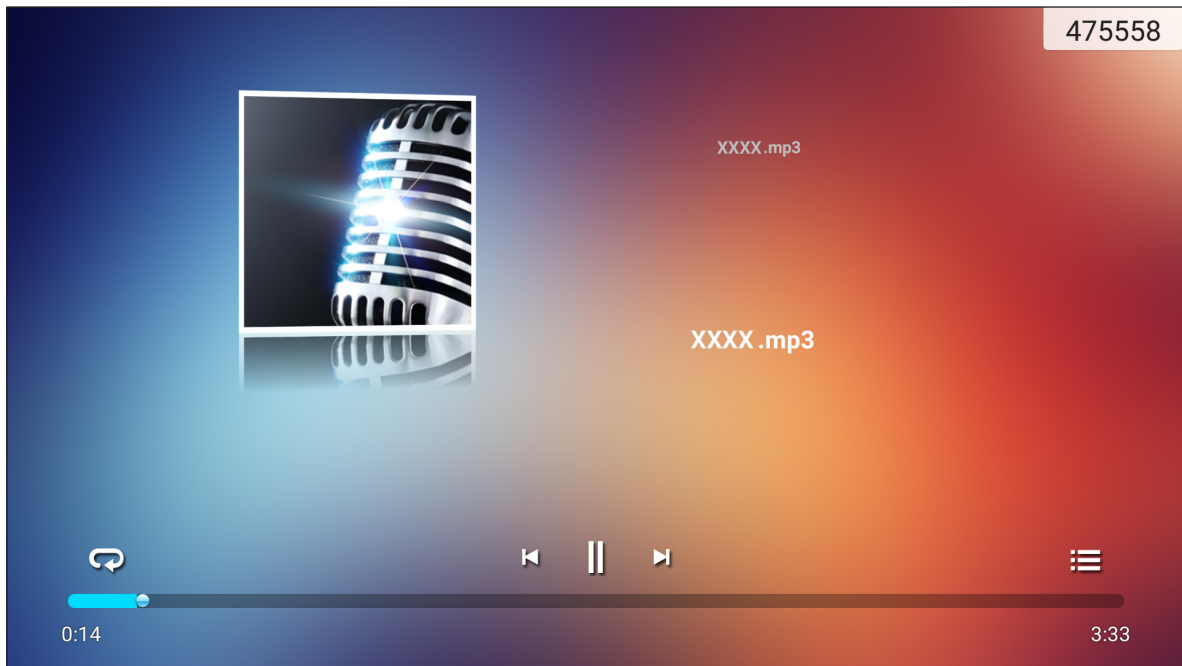

Playing music

Select the song you want play and tap ▶ to start the playback.



During the playback, you can do the following:

Item	Description
 Repeat	Select the repeat mode.
 Pause	Pause the playback. To resume, tap ▶.
 Previous track	Skip to the previous track.
 Next track	Skip to the next track.
 Playlist	View the playlist.

Note: To stop playback at any time, tap  or  to display the side toolbar. Then tap .

USING THE APPS

Viewing photos

Tap to select a photo and view the selected photo in full screen.

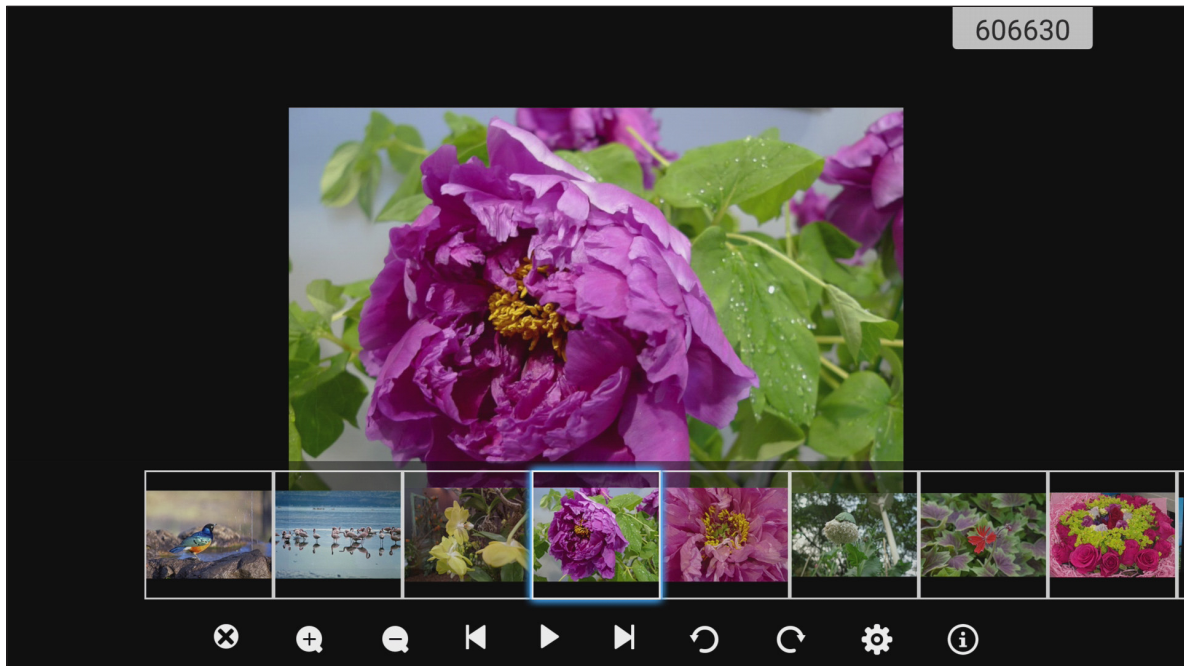

Item		Description
	Exit	Exit full screen mode.
	Zoom in	Magnify the photo.
	Zoom out	Zoom out on the magnified photo.
	Previous photo	Skip to the previous photo
	Slide show	Start the slide show. To stop, tap
	Next photo	Skip to the next photo.
	Rotate Left	Rotate the photo 90-degree counter-clockwise.
	Rotate Right	Rotate the photo 90-degree clockwise.
	Settings	Configure the wallpaper and slide show settings.
	Information	Display the photo information.

USING THE APPS

Set a wallpaper

1. Select your desired photo and tap .
2. Select **Set to wallpaper**.

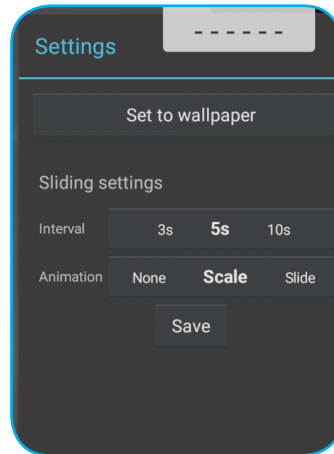

3. Drag the white circles at each corner to resize the crop area and tap **SAVE** to set the photo as the wallpaper.

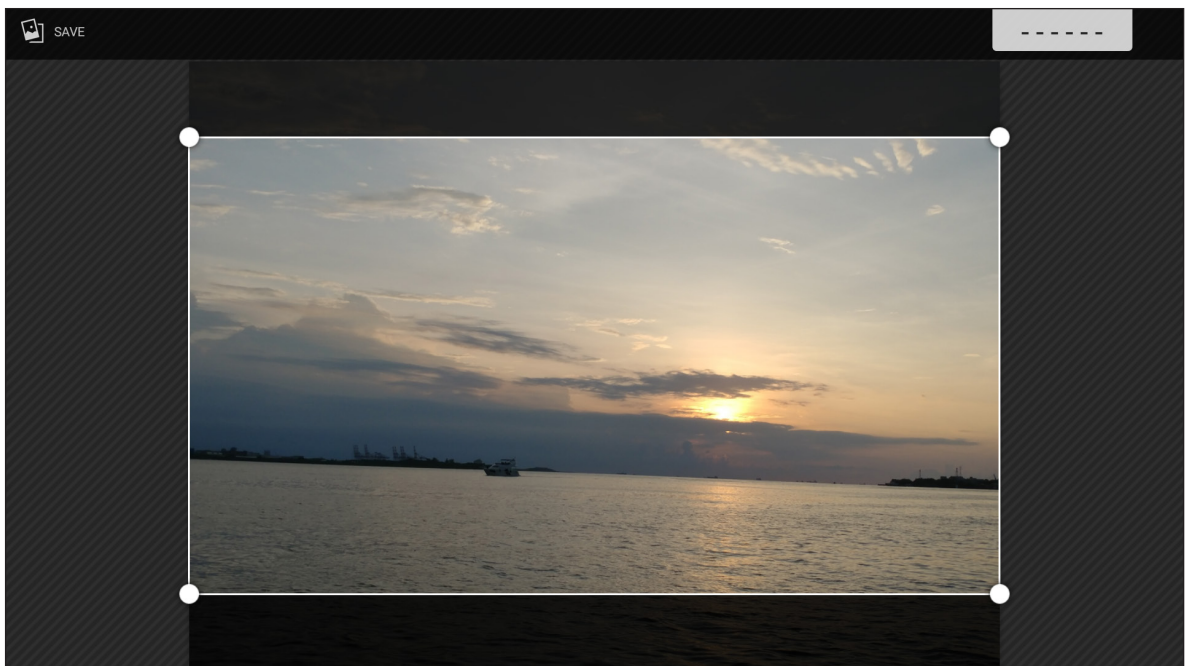

USING THE APPS

Screen Lock

Select **Screen Lock** to set the 4-digit pin code. Using the pin code, you can block the device from unauthorized use.

To set the pin code for the first time:

1. Launch the **Screen Lock** app. Then tap **Set password**.

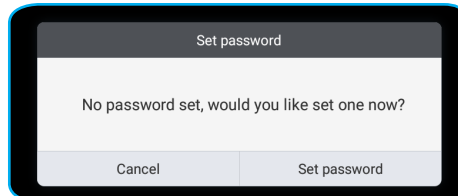

2. Tap **Set** to set the pin code.

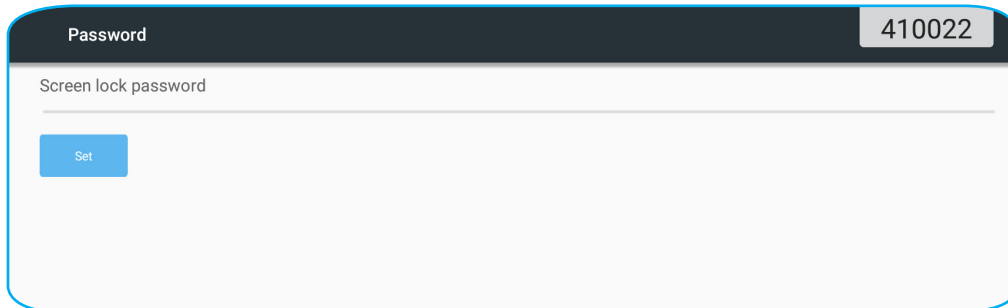

3. Enter the 4-digit pin code in the **New Password** and **Confirm Password** fields. Then tap **OK**.

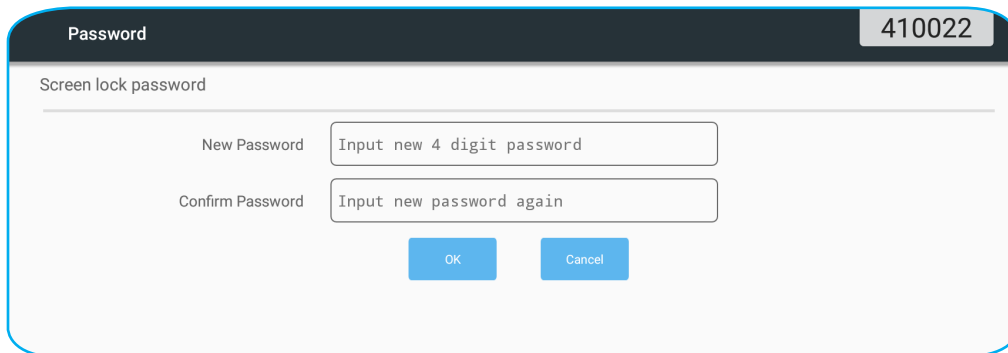

- If you want to change the password, tap **Change**.
- If you want to remove the password, tap **Clear**.

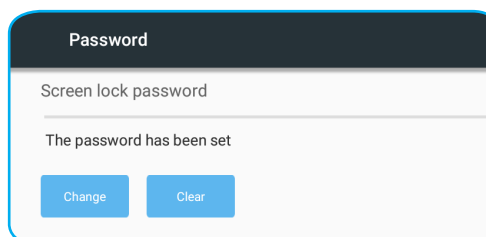

USING THE APPS

Once the password is set, open the **Screen Lock** app when you want to leave the device unattended for a while. Only the person who knows the password can access the device.

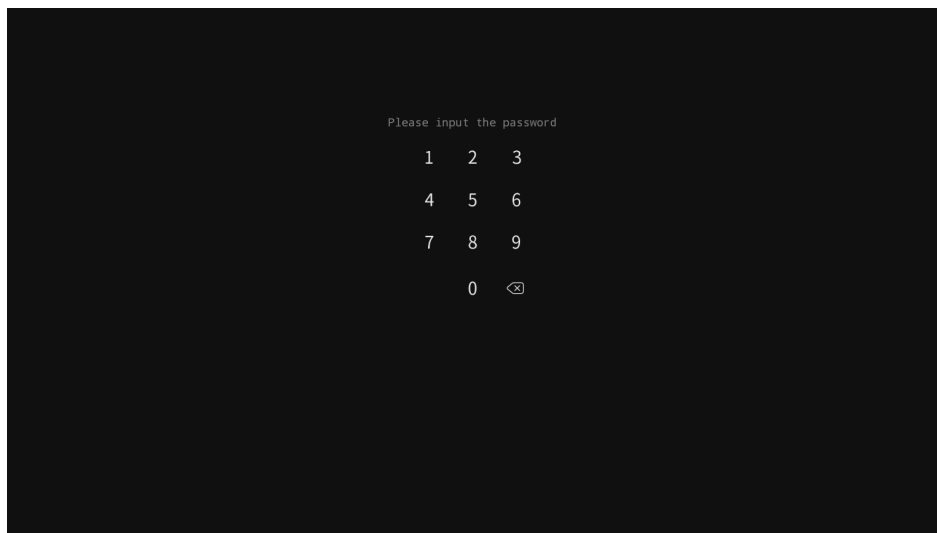

USING THE APPS

Browser

Select **Browser** to access the web pages.

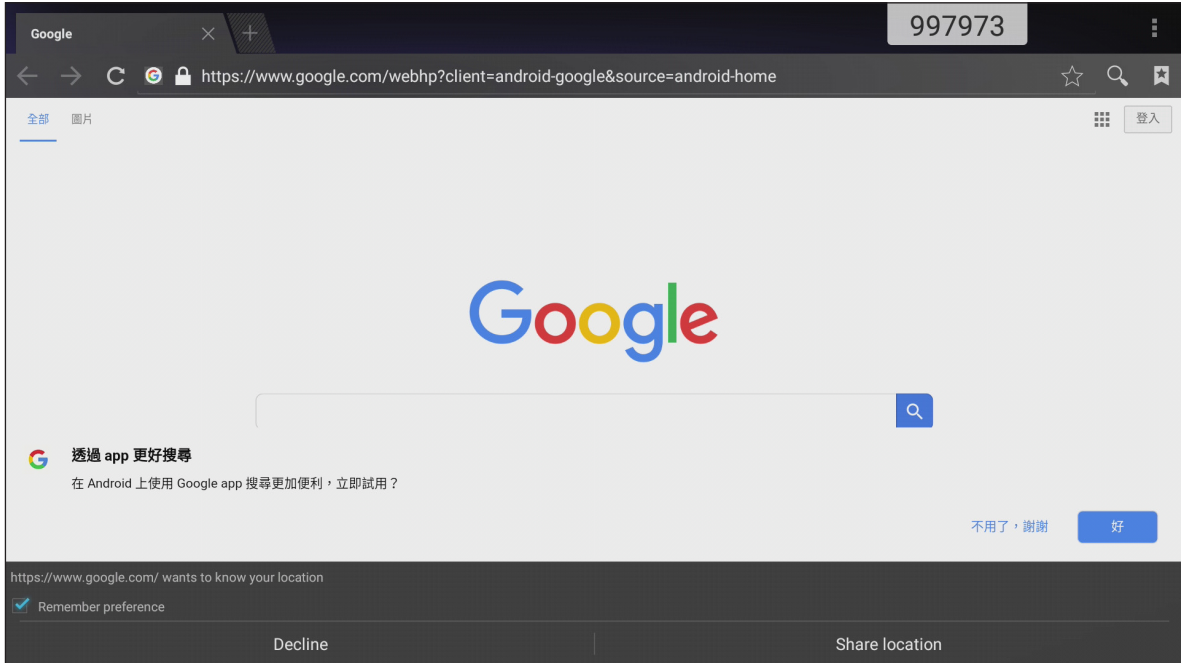

Keeper

Select **Keeper** to clean and optimize the data on the device.

Tap **One Key Optimize** to clean the memory and delete the temporary and junk files simultaneously.

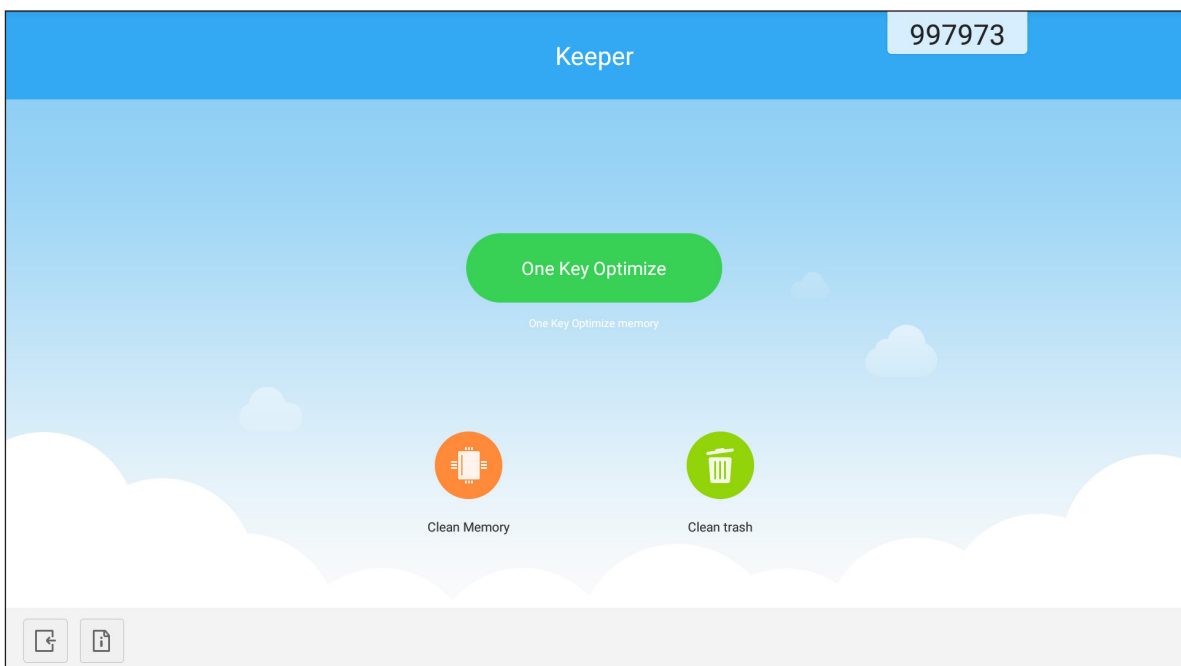

Otherwise, tap  or  to perform the cleaning task separately.

USING THE APPS

System Update

Select **System Update** to check and download the latest firmware version. Every time you turn on the device, the system will automatically check if a newer firmware version is available when the device is connected to the Internet.

IMPORTANT!

- *When you open the **System Update** app for the first time, the two permission messages will appear on the screen. Tap **Allow** to continue. Then the app will have IFP's authorization to check if there is any new firmware in the server and remind the user to update.*

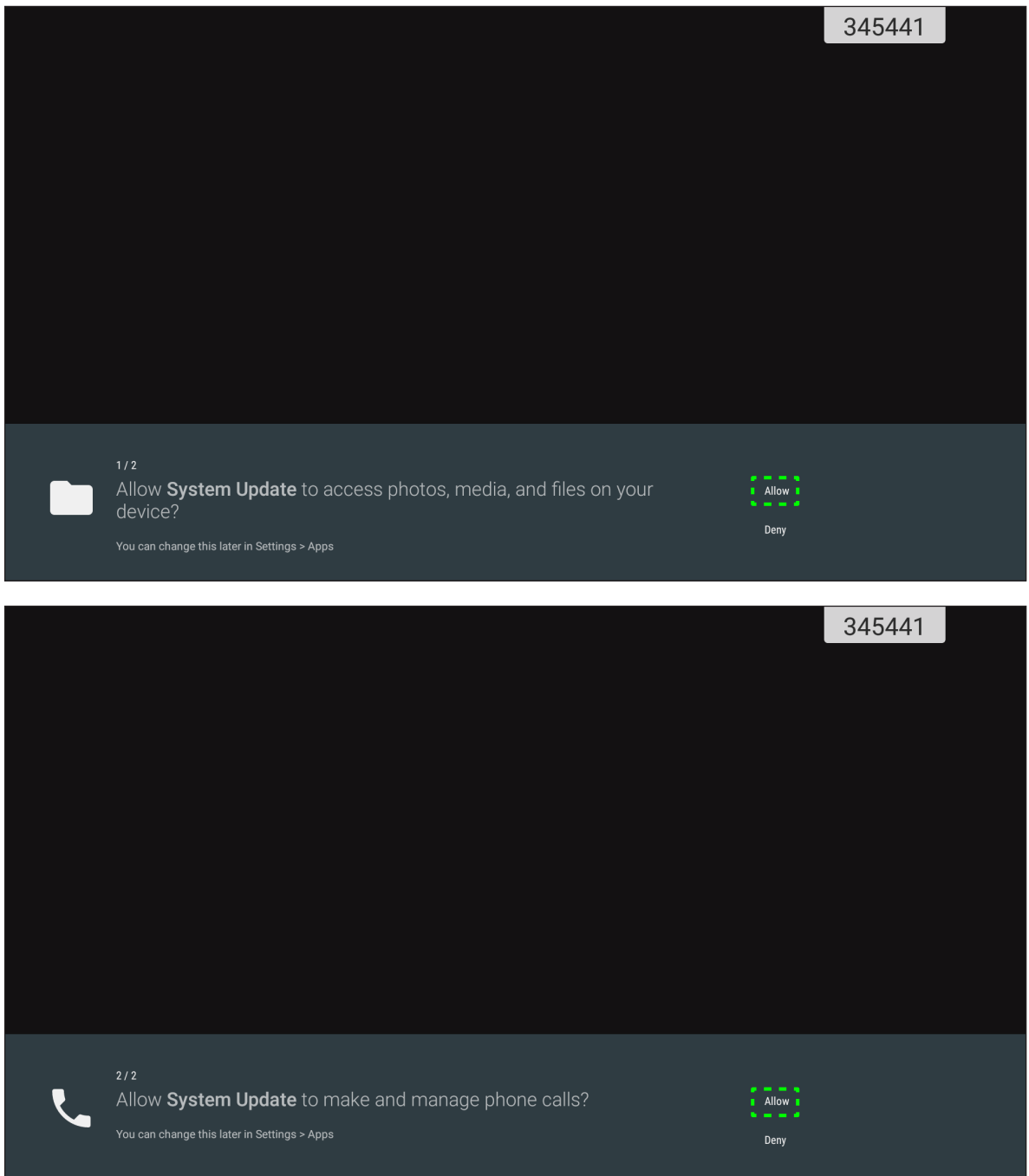

- *You can also change this setting later (in **Settings** → **Apps** → **System Update** → **Permission**).*
- *The system can only check availability of new firmware if the device is properly connected to the Internet.*

USING THE APPS

1. Whenever a new version of firmware is available, the system will automatically detect the update and will prompt you to download it. Select **UPDATE** to proceed with the update process.

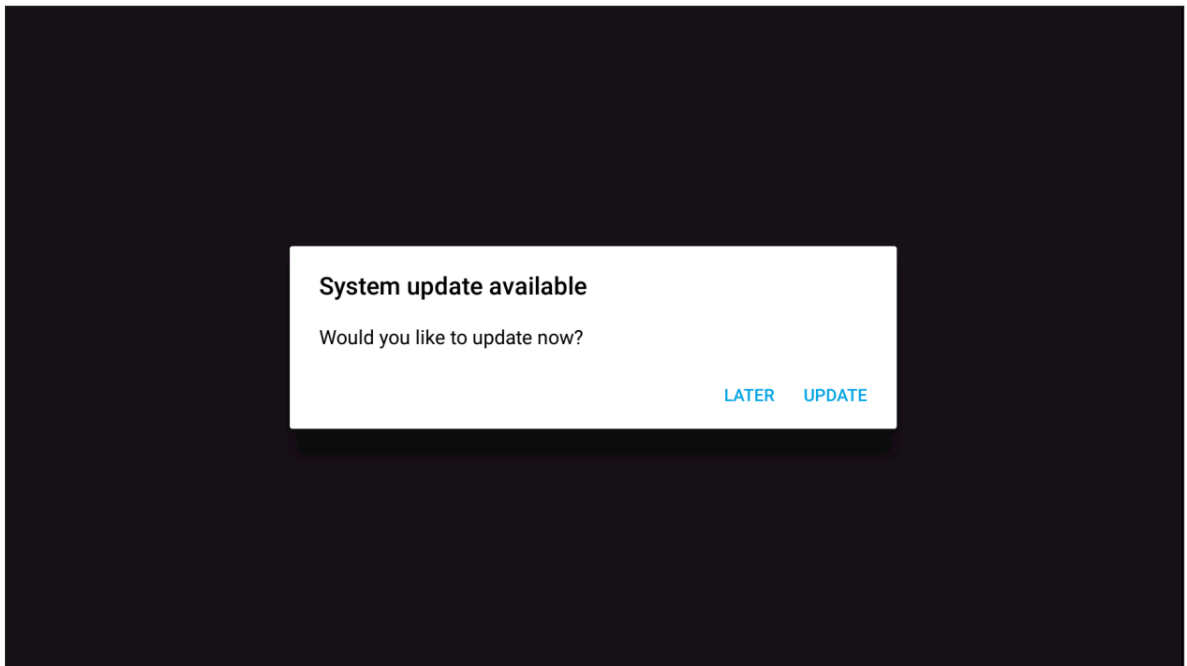

2. A list of issues fixed in the latest update will appear on the screen. To continue, select **Update**.

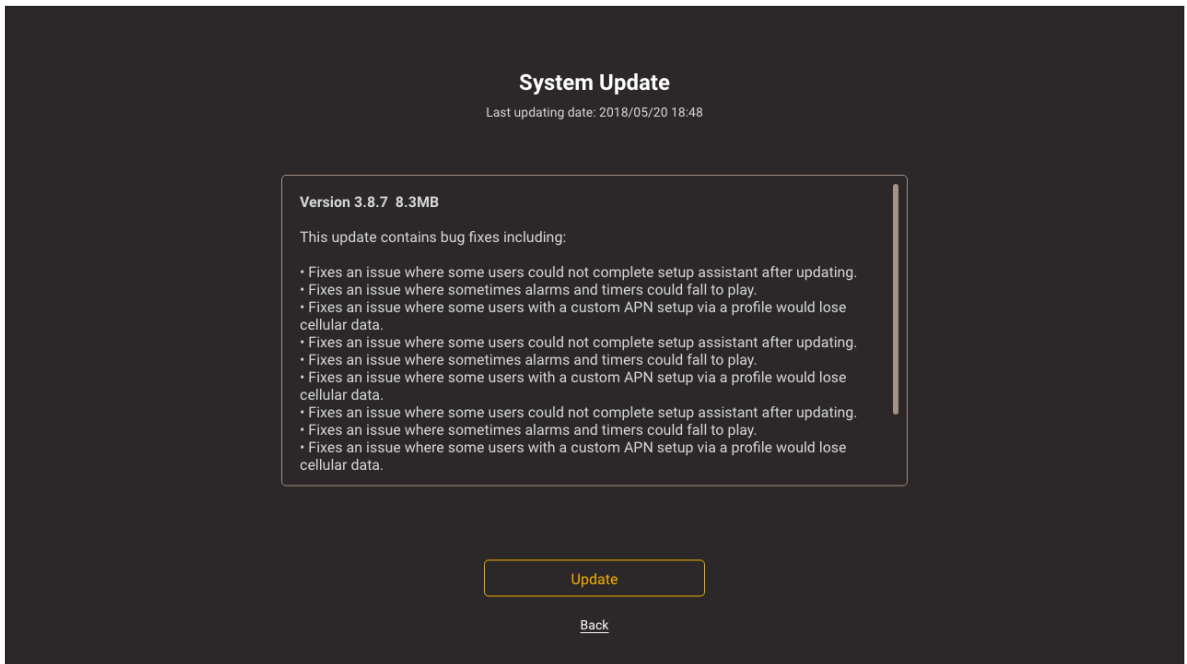

USING THE APPS

The system will automatically download the latest firmware to the device.

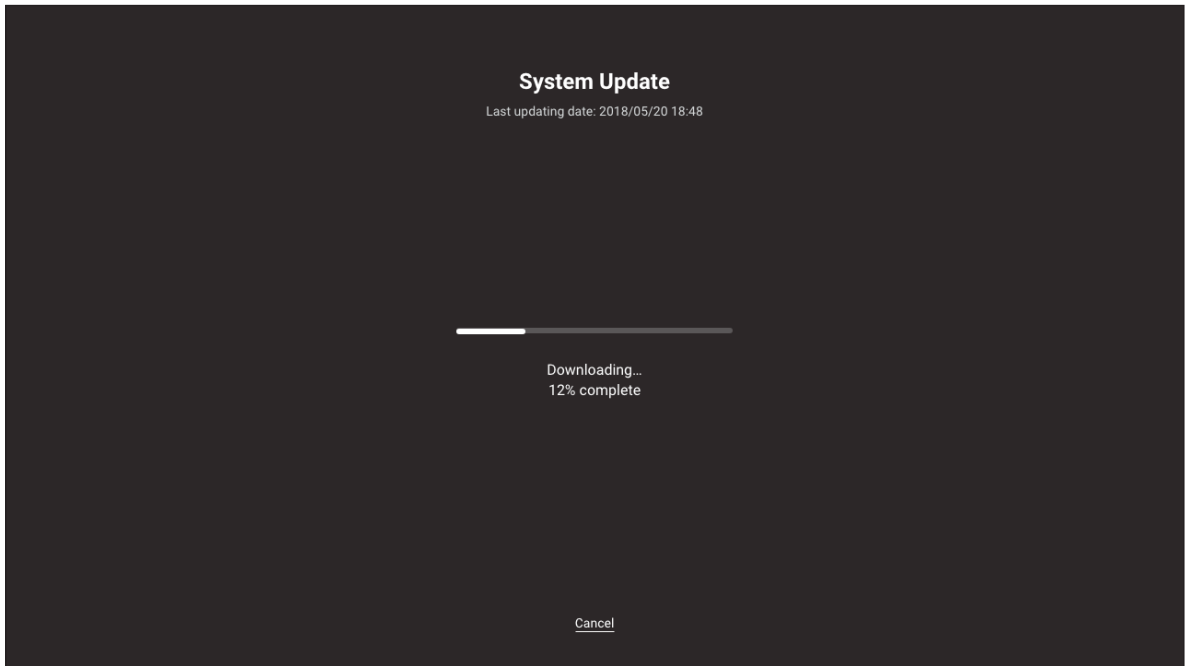

3. Once the firmware has been downloaded, select **YES** to continue updating the system.

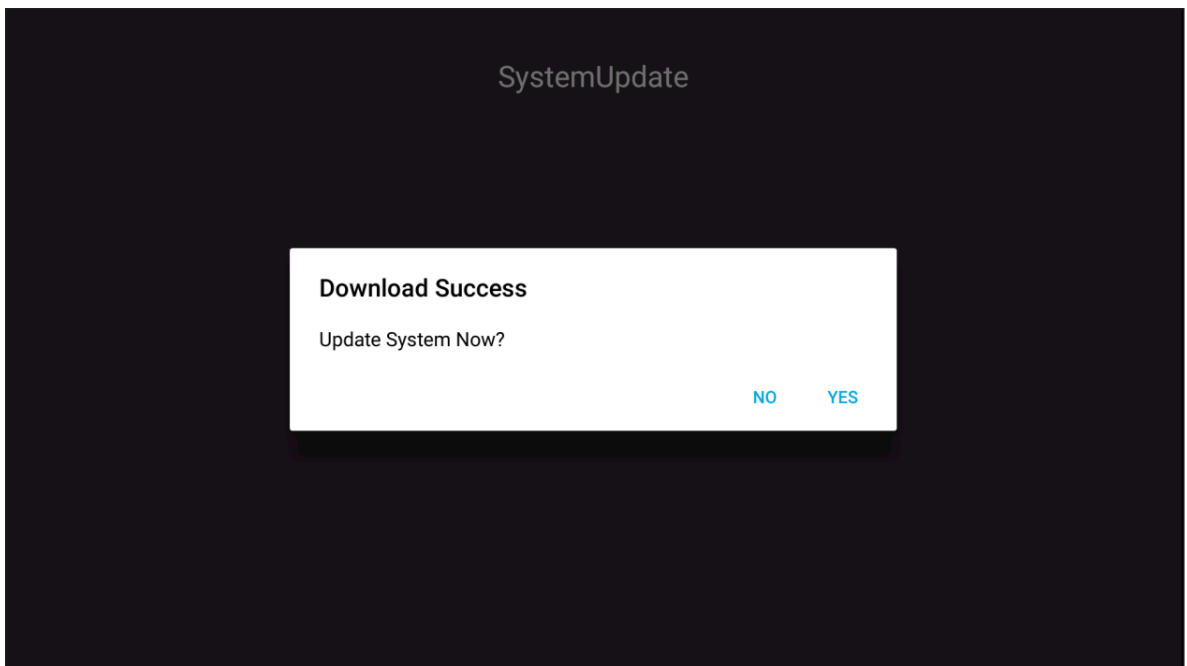

USING THE APPS

4. The device will restart in 30 seconds and the firmware installation will begin automatically. Wait until the installation process is complete.

IMPORTANT! *During the update process, do not turn off your device. Any interruption would bring damage to the device.*

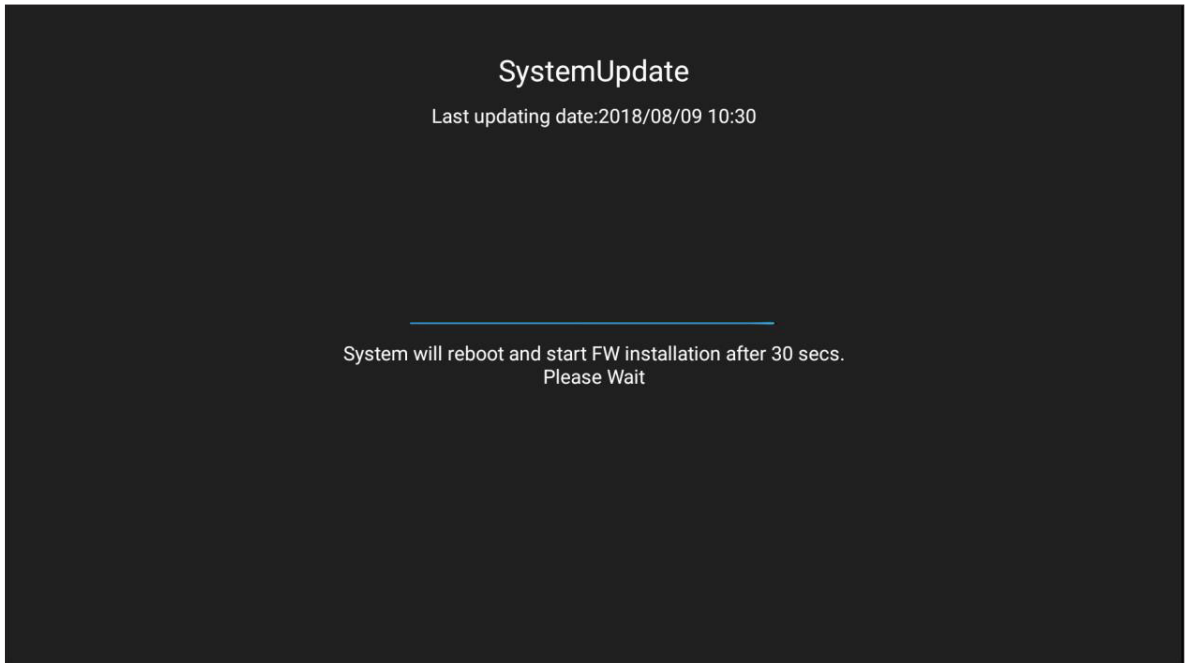

5. After the new firmware is installed, the system will restart again to complete the whole update process.

ADDITIONAL INFORMATION

Specifications

Item	65" 4K	75" 4K	86" 4K
Display			
Backlight	LED	LED	LED
Resolution	3840 x 2160 (4K UHD)	3840 x 2160 (4K UHD)	3840 x 2160 (4K UHD)
Brightness (cd/m ²)	350	350	350
Contrast	1,200:1	1,200:1	1,200:1
View Angle	178°	178°	178°
Response Time (ms)	6	8	8
Life Time	30,000 hr	30,000 hr	30,000 hr
Display Colors	1.07 B	1.07 B	1.07 B
Audio	2x 12W	2x 12W	2x 12W
Surface Hardness	7H	7H	7H
Glass	Anti glare	Anti glare	Anti glare
Power			
Power Supply	AC 100v-240v	AC 100v-240v	AC 100v-240v
Power Source (Hz)	50/60Hz	50/60Hz	50/60Hz
Power Consumption	300W	450W	500W
Standby Power Consumption	≤ 0.5W	≤ 0.5W	≤ 0.5W
Dimensions			
Dimension	59.88" x 35.98" x 3.86"	69.41" x 40.71" x 3.94"	78.27" x 46.38" x 3.94"
Packing Dimension	66.81" x 42.17" x 8.66"	5.32" x 48.23" x 11.02"	87.05" x 53.94" x 11.02"
Net Weight	100.5 lb	129.2 lb	166.4 lb
Gross Weight	121.3 lb	172.0 lb	231.5 lb
Connectivity			
VGA IN	1	1	1
HDMI 2.0 IN	3	3	3
HDMI OUT 1.4	1	1	1
AUDIO IN	1	1	1
AUDIO OUT	1	1	1
COAX OUT	1	1	1
USB 2.0	4	4	4
USB 3.0	2	2	2
RS232	1	1	1
RJ45	1	1	1
USB TOUCH OUT	2	2	2
AV IN	1	1	1
MODULE SLOT	1	1	1

ADDITIONAL INFORMATION

Item	65" 4K	75" 4K	86" 4K
Compatible Operation System			
Touch Type	IR	IR	IR
System Compatibility	Windows 10 Windows 8 Windows 7 Windows Vista Windows XP Windows 2000/Linux Mac/Android	Windows 10 Windows 8 Windows 7 Windows Vista Windows XP Windows 2000/Linux Mac/Android	Windows 10 Windows 8 Windows 7 Windows Vista Windows XP Windows 2000/Linux Mac/Android
Touch Point	Up to 20 points touch Note: <i>The number of touch points can vary depending on operating system and application.</i>		
OS System			
Android	Android 7.0	Android 7.0	Android 7.0
CPU	ARM Cortex A73 Dual Core	ARM Cortex A73 Dual Core	ARM Cortex A73 Dual Core
GPU	Mali-450 (5 Core)	Mali-450 (5 Core)	Mali-450 (5 Core)
RAM	2GB	2GB	2GB
Storage	16GB	16GB	16GB
Wi-Fi	802.11 b/g/n (via USB adapter)	802.11 b/g/n (via USB adapter)	802.11 b/g/n (via USB adapter)

Note: All specifications are subject to change without notice.

ADDITIONAL INFORMATION

Dimensions

65-inch

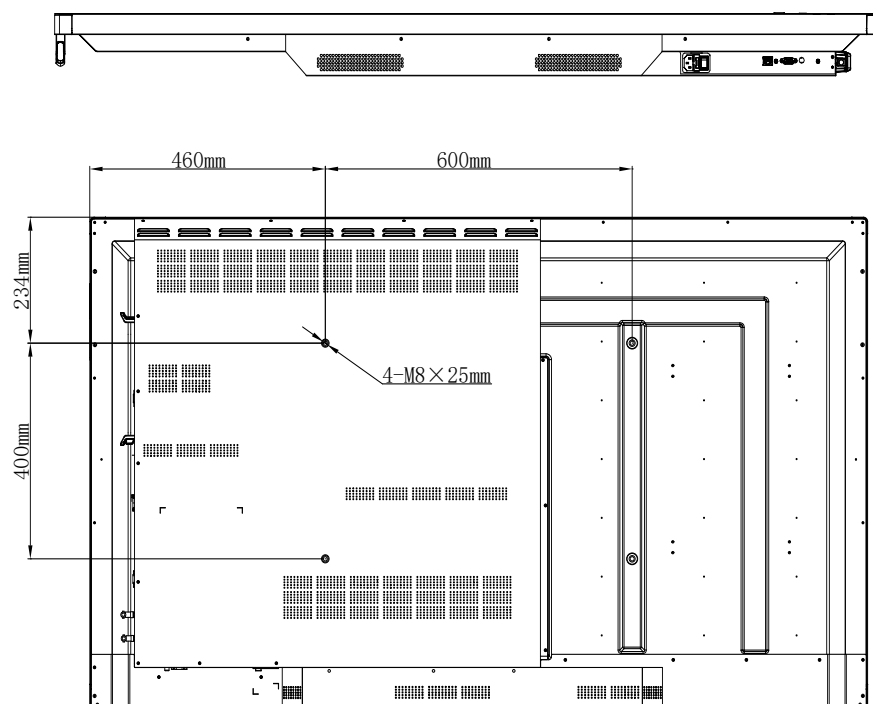
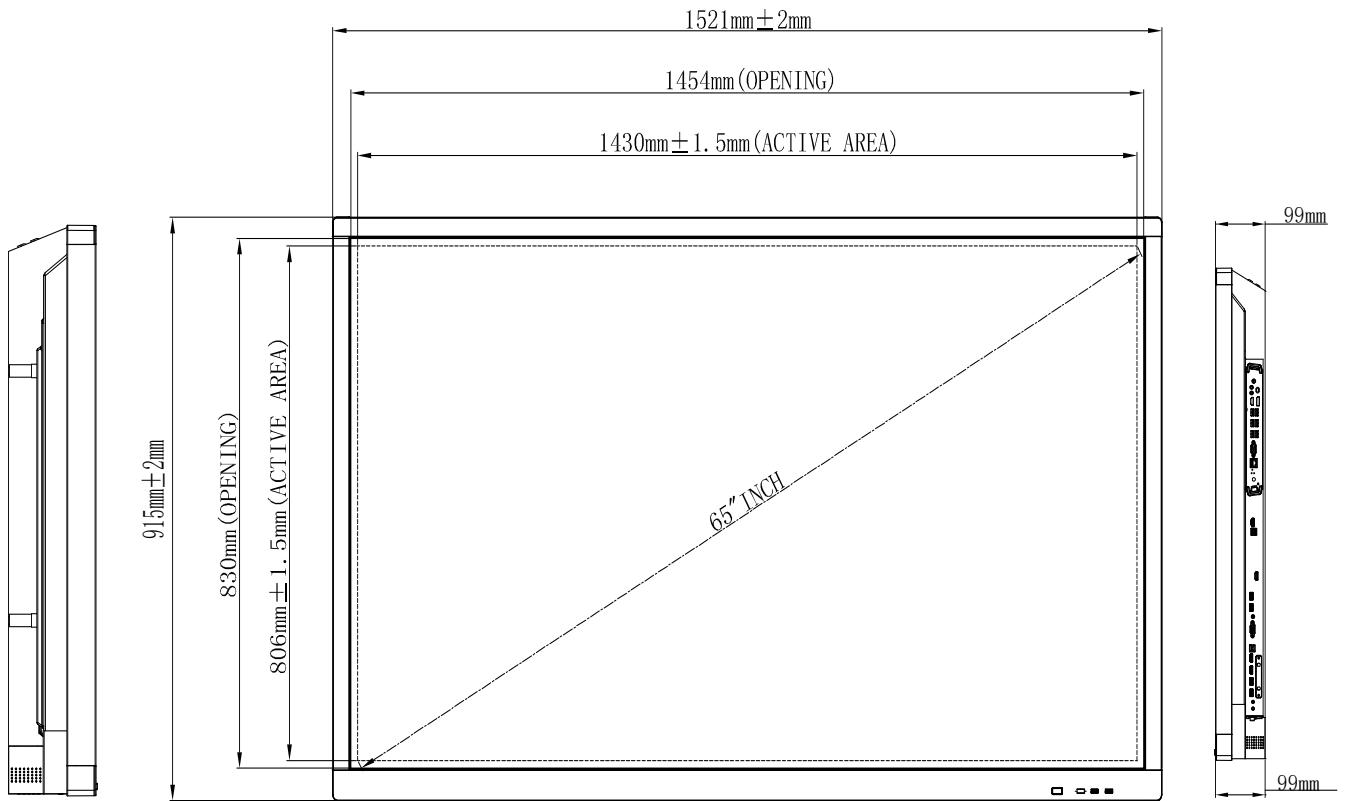

Unit:mm

ADDITIONAL INFORMATION

75-inch

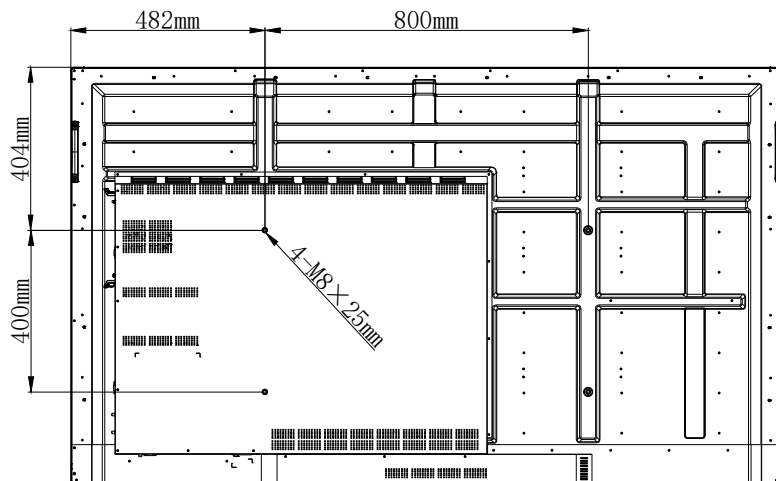
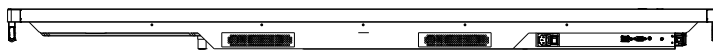
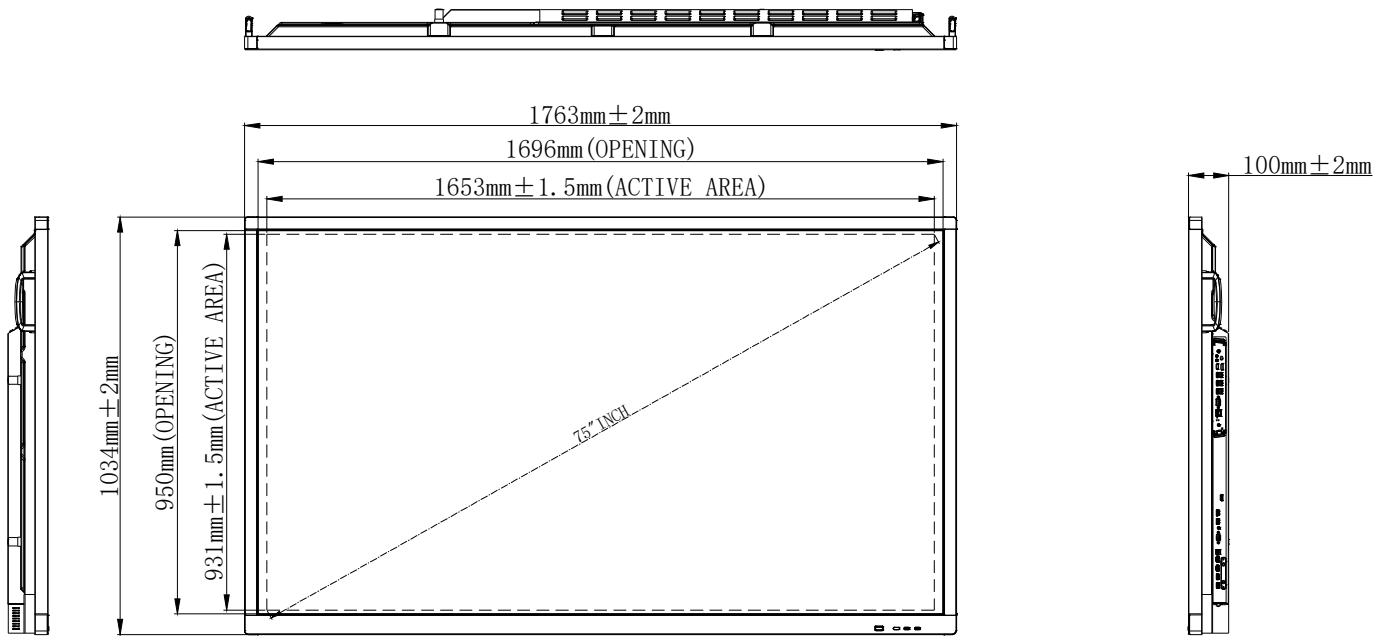

Unit: mm

ADDITIONAL INFORMATION

86-inch

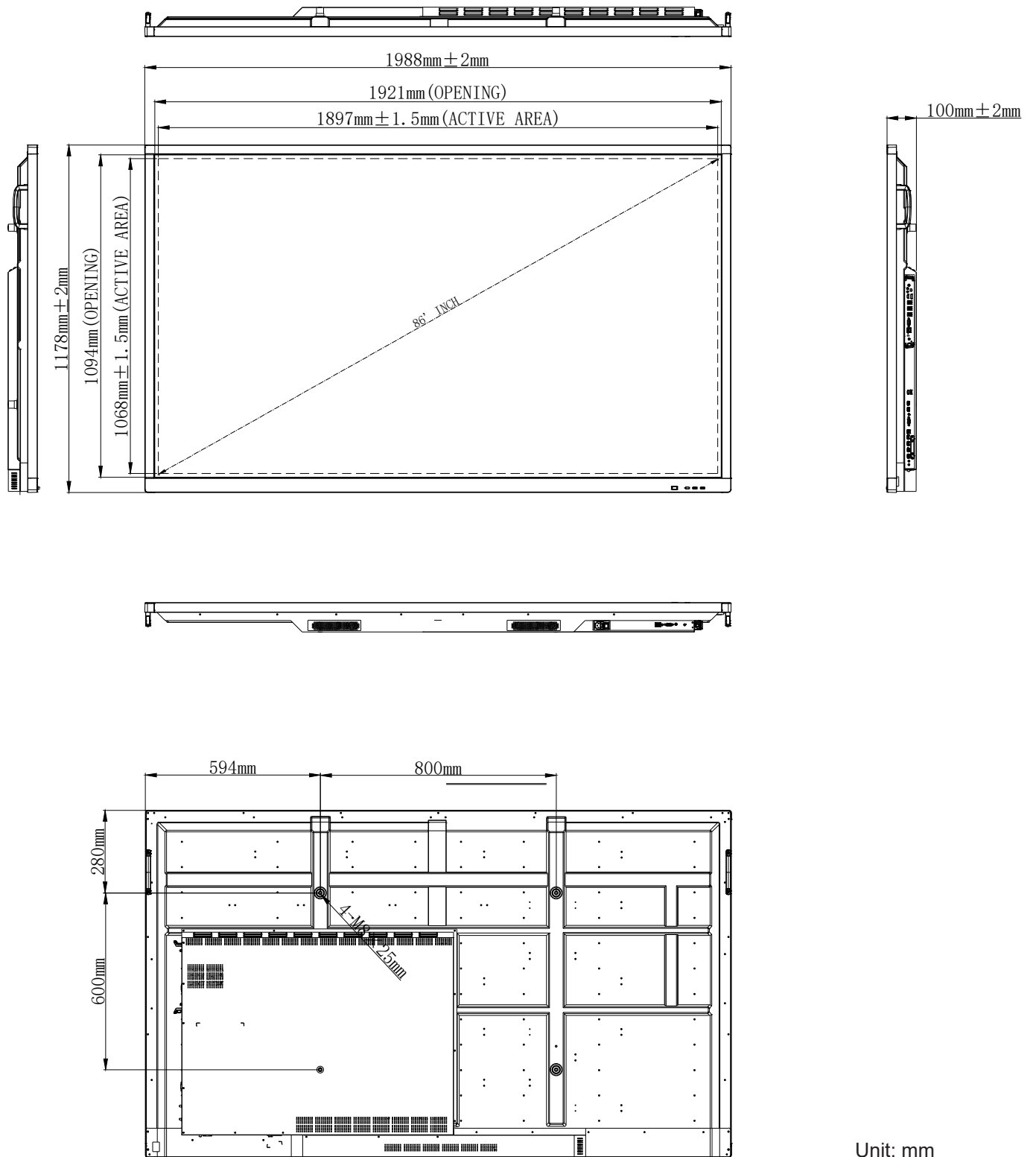

Unit: mm

ADDITIONAL INFORMATION

Supported Timing List

Resolution	Input Source		
	HDMI	VGA	AV
640 x 480 @60Hz	√	√	-
720 x 400 @70Hz	√	√	-
800 x 600 @60Hz	√	√	-
1024 x 768 @60Hz	√	√	-
1024 x 768 @75Hz	√	√	-
1280 x 720 @60Hz	√	√	-
1280 x 768 @60Hz	√	√	-
1280 x 800 @60Hz	√	√	-
1280 x 960 @60Hz	√	√	-
1280 x 1024 @60Hz	√	√	-
1366 x 768 @60Hz	√	√	-
1440 x 900 @60Hz	√	√	-
1600 x 1200 @60Hz	√	√	-
1680 x 1050 @60Hz	√	√	-
1920 x 1080 @50Hz	√	√	-
1920 x 1080 @60Hz	√	√	-
3840 x 2160 @30Hz	√	-	-
3840 x 2160 @50Hz	√	-	-
3840 x 2160 @60Hz	√	-	-
NTSC-M	-	-	√
NTSC-J	-	-	√
PAL-BDGI	-	-	√
480i (60Hz)	√	-	-
480p (60Hz)	√	-	-
576i (50Hz)	√	-	-
576p (50Hz)	√	-	-
720p (50Hz)	√	-	-
720p (60Hz)	√	-	-
1080i (50Hz)	√	-	-
1080i (60Hz)	√	-	-
1080p (24Hz)	√	-	-
1080p (50Hz)	√	-	-
1080p (60Hz)	√	-	-
2160p (50Hz)	√	-	-
2160p (60Hz)	√	-	-

Note: “-” indicates the current input timing is not supported by the device.

ADDITIONAL INFORMATION

RS232 Protocol Function List

RS232 Pin Assignments

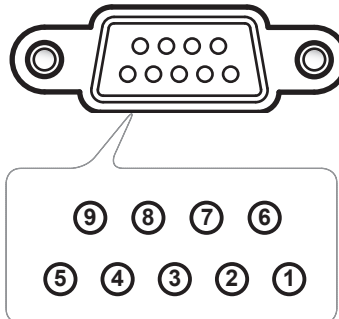

Pin No.	Spec. (from IFP side)
1	N/A
2	TXD
3	RXD
4	N/A
5	GND
6	N/A
7	N/A
8	N/A

RS232 RJ45 Control Connection

RS232 Settings	
Baud Rate	9600
Data Bits	8
Parity	None
Stop Bits	1
Flow Control	None

LAN Control Settings	
IP	Machine IP
Port	4664

:	0	1	S	X	X	X	X	CR
Lead Code	Set command			Command ID	Variable			carriage return

:	0	1	G	X	0	0	0	CR
Lead Code	Get command			Command ID	Fixed number			carriage return

ADDITIONAL INFORMATION

SET Command

Type	Category	Parameter	CMD		Hex Code CMD	Response			
						Success	Failed	Success (Hex)	Failed (Hex)
SET	Power	Backlight off	:01S0n	n=000	3A 30 31 53 30 30 30 30 0d	401+	401-	34 30 31 2B 0D	34 30 31 2D 0D
		Backlight on		n=001	3A 30 31 53 30 30 30 31 0d	401+	401-	34 30 31 2B 0D	34 30 31 2D 0D
		Power off		n=002	3A 30 31 53 30 30 30 32 0d	401+	401-	34 30 31 2B 0D	34 30 31 2D 0D
		Power on		n=003	3A 30 31 53 30 30 30 33 0d	401+	401-	34 30 31 2B 0D	34 30 31 2D 0D
SET	Treble	000 ~ 100	:01S1n	n=000-100	3A 30 31 53 31 30 30 30 0d to 3A 30 31 53 31 31 30 30 0d	401+	401-	34 30 31 2B 0D	34 30 31 2D 0D
SET	Bass	000 ~ 100	:01S2n	n=000-100	3A 30 31 53 32 30 30 30 0d to 3A 30 31 53 32 31 30 30 0d	401+	401-	34 30 31 2B 0D	34 30 31 2D 0D
SET	Balance	000 ~ 100	:01S3n	n=000-100	3A 30 31 53 33 30 30 30 0d to 3A 30 31 53 33 31 30 30 0d	401+	401-	34 30 31 2B 0D	34 30 31 2D 0D
SET	Contrast	000 ~ 100	:01S4n	n=000-100	3A 30 31 53 34 30 30 30 0d to 3A 30 31 53 34 31 30 30 0d	401+	401-	34 30 31 2B 0D	34 30 31 2D 0D
SET	Brightness	000 ~ 100	:01S5n	n=000-100	3A 30 31 53 35 30 30 30 0d to 3A 30 31 53 35 31 30 30 0d	401+	401-	34 30 31 2B 0D	34 30 31 2D 0D
SET	Sharpness	000 ~ 100	:01S6n	n=000-100	3A 30 31 53 36 30 30 30 0d to 3A 30 31 53 36 31 30 30 0d	401+	401-	34 30 31 2B 0D	34 30 31 2D 0D
SET	Sound Mode	Standard	:01S7n	n=001	3A 30 31 53 37 30 30 31 0d	401+	401-	34 30 31 2B 0D	34 30 31 2D 0D
		Custom		n=002	3A 30 31 53 37 30 30 32 0d	401+	401-	34 30 31 2B 0D	34 30 31 2D 0D
		Classroom		n=003	3A 30 31 53 37 30 30 33 0d	401+	401-	34 30 31 2B 0D	34 30 31 2D 0D
		Meeting		n=004	3A 30 31 53 37 30 30 34 0d	401+	401-	34 30 31 2B 0D	34 30 31 2D 0D
SET	Volume	000 ~ 100	:01S8n	n=000-100	3A 30 31 53 38 30 30 30 0d to 3A 30 31 53 38 31 30 30 0d	401+	401-	34 30 31 2B 0D	34 30 31 2D 0D
SET	Mute	Off	:01S9n	n=000	3A 30 31 53 39 30 30 30 0d	401+	401-	34 30 31 2B 0D	34 30 31 2D 0D
		On		n=001	3A 30 31 53 39 30 30 31 0d	401+	401-	34 30 31 2B 0D	34 30 31 2D 0D
SET	Video Source	VGA	:01S;n	n=000	3A 30 31 53 3A 30 30 30 0d	401+	401-	34 30 31 2B 0D	34 30 31 2D 0D
		HDMI1		n=001	3A 30 31 53 3A 30 30 31 0d	401+	401-	34 30 31 2B 0D	34 30 31 2D 0D
		HDMI2		n=002	3A 30 31 53 3A 30 30 32 0d	401+	401-	34 30 31 2B 0D	34 30 31 2D 0D
		AV		n=003	3A 30 31 53 3A 30 30 33 0d	401+	401-	34 30 31 2B 0D	34 30 31 2D 0D
		Android		n=101	3A 30 31 53 3A 31 30 31 0d	401+	401-	34 30 31 2B 0D	34 30 31 2D 0D
		Slot in PC		n=103	3A 30 31 53 3A 31 30 33 0d	401+	401-	34 30 31 2B 0D	34 30 31 2D 0D
SET	Aspect Ratio	16:9	:01S;n	n=000	3A 30 31 53 3B 30 30 30 0d	401+	401-	34 30 31 2B 0D	34 30 31 2D 0D
		4:3		n=001	3A 30 31 53 3B 30 30 31 0d	401+	401-	34 30 31 2B 0D	34 30 31 2D 0D
		PTP		n=002	3A 30 31 53 3B 30 30 32 0d	401+	401-	34 30 31 2B 0D	34 30 31 2D 0D

ADDITIONAL INFORMATION

Type	Category	Parameter	CMD		Hex Code CMD	Response			
						Success	Failed	Success (Hex)	Failed (Hex)
SET	Language	English	:01S<n	n=000	3A 30 31 53 3C 30 30 30 0d	401+	401-	34 30 31 2B 0D	34 30 31 2D 0D
		Français		n=001	3A 30 31 53 3C 30 30 31 0d	401+	401-	34 30 31 2B 0D	34 30 31 2D 0D
		Español		n=002	3A 30 31 53 3C 30 30 32 0d	401+	401-	34 30 31 2B 0D	34 30 31 2D 0D
		Traditional Chinese		n=003	3A 30 31 53 3C 30 30 33 0d	401+	401-	34 30 31 2B 0D	34 30 31 2D 0D
		Simplified Chinese		n=004	3A 30 31 53 3C 30 30 34 0d	401+	401-	34 30 31 2B 0D	34 30 31 2D 0D
		Português		n=005	3A 30 31 53 3C 30 30 35 0d	401+	401-	34 30 31 2B 0D	34 30 31 2D 0D
		German		n=006	3A 30 31 53 3C 30 30 36 0d	401+	401-	34 30 31 2B 0D	34 30 31 2D 0D
		Dutch		n=007	3A 30 31 53 3C 30 30 37 0d	401+	401-	34 30 31 2B 0D	34 30 31 2D 0D
		Polish		n=008	3A 30 31 53 3C 30 30 38 0d	401+	401-	34 30 31 2B 0D	34 30 31 2D 0D
		Russia		n=009	3A 30 31 53 3C 30 30 39 0d	401+	401-	34 30 31 2B 0D	34 30 31 2D 0D
		Czech		n=010	3A 30 31 53 3C 30 31 30 0d	401+	401-	34 30 31 2B 0D	34 30 31 2D 0D
		Danish		n=011	3A 30 31 53 3C 30 31 31 0d	401+	401-	34 30 31 2B 0D	34 30 31 2D 0D
		Swedish		n=012	3A 30 31 53 3C 30 31 32 0d	401+	401-	34 30 31 2B 0D	34 30 31 2D 0D
		Italian		n=013	3A 30 31 53 3C 30 31 33 0d	401+	401-	34 30 31 2B 0D	34 30 31 2D 0D
		Turkish		n=018	3A 30 31 53 3C 30 31 38 0d	401+	401-	34 30 31 2B 0D	34 30 31 2D 0D
		Arabic		n=019	3A 30 31 53 3C 30 31 39 0d	401+	401-	34 30 31 2B 0D	34 30 31 2D 0D
Ukrayina	n=021	3A 30 31 53 3C 30 32 31 0d	401+	401-	34 30 31 2B 0D	34 30 31 2D 0D			
SET	Picture Mode	Standard	:01S=n	n=000	3A 30 31 53 3D 30 30 30 0d	401+	401-	34 30 31 2B 0D	34 30 31 2D 0D
		Bright		n=001	3A 30 31 53 3D 30 30 31 0d	401+	401-	34 30 31 2B 0D	34 30 31 2D 0D
		Soft		n=002	3A 30 31 53 3D 30 30 32 0d	401+	401-	34 30 31 2B 0D	34 30 31 2D 0D
		Customer		n=003	3A 30 31 53 3D 30 30 33 0d	401+	401-	34 30 31 2B 0D	34 30 31 2D 0D
SET	Hue (Color)	000 ~ 100	:01S>n	n=000-100	3A 30 31 53 3E 30 30 30 0d to 3A 30 31 53 3E 31 30 30 0d	401+	401-	34 30 31 2B 0D	34 30 31 2D 0D
SET	Backlight	000 ~ 100	:01S?n	n=000-100	3A 30 31 53 3F 30 30 30 0d to 3A 30 31 53 3F 31 30 30 0d	401+	401-	34 30 31 2B 0D	34 30 31 2D 0D
SET	Color Temp	Cool	:01S@n	n=000	3A 30 31 53 40 30 30 30 0d	401+	401-	34 30 31 2B 0D	34 30 31 2D 0D
		Standard		n=001	3A 30 31 53 40 30 30 31 0d	401+	401-	34 30 31 2B 0D	34 30 31 2D 0D
		Warm		n=002	3A 30 31 53 40 30 30 32 0d	401+	401-	34 30 31 2B 0D	34 30 31 2D 0D
SET	Remote control command	Vol +	:01SAn	n=000	3A 30 31 53 41 30 30 30 0d	401+	401-	34 30 31 2B 0D	34 30 31 2D 0D
		Vol -		n=001	3A 30 31 53 41 30 30 31 0d	401+	401-	34 30 31 2B 0D	34 30 31 2D 0D
		Remote UP		n=010	3A 30 31 53 41 30 31 30 0d	401+	401-	34 30 31 2B 0D	34 30 31 2D 0D
		Remote DOWN		n=011	3A 30 31 53 41 30 31 31 0d	401+	401-	34 30 31 2B 0D	34 30 31 2D 0D
		Remote LEFT		n=012	3A 30 31 53 41 30 31 32 0d	401+	401-	34 30 31 2B 0D	34 30 31 2D 0D
		Remote RIGHT		n=013	3A 30 31 53 41 30 31 33 0d	401+	401-	34 30 31 2B 0D	34 30 31 2D 0D
		Remote OK		n=014	3A 30 31 53 41 30 31 34 0d	401+	401-	34 30 31 2B 0D	34 30 31 2D 0D
		Remote Menu Key		n=020	3A 30 31 53 41 30 32 30 0d	401+	401-	34 30 31 2B 0D	34 30 31 2D 0D

ADDITIONAL INFORMATION

Type	Category	Parameter	CMD		Hex Code CMD	Response			
						Success	Failed	Success (Hex)	Failed (Hex)
SET	Remote control command	Remote Input source	:01SAn	n=021	3A 30 31 53 41 30 32 31 0d	401+	401-	34 30 31 2B 0D	34 30 31 2D 0D
		Remote Exit		n=022	3A 30 31 53 41 30 32 32 0d	401+	401-	34 30 31 2B 0D	34 30 31 2D 0D
		Blank		n=031	3A 30 31 53 41 30 33 31 0d	401+	401-	34 30 31 2B 0D	34 30 31 2D 0D
		Freeze		n=032	3A 30 31 53 41 30 33 32 0d	401+	401-	34 30 31 2B 0D	34 30 31 2D 0D
SET	Remote control (IR LOCK)	Disable	:01SBn	n=000	3A 30 31 53 42 30 30 30 0d	401+	401-	34 30 31 2B 0D	34 30 31 2D 0D
		Enable		n=001	3A 30 31 53 42 30 30 31 0d	401+	401-	34 30 31 2B 0D	34 30 31 2D 0D

GET Command

Type	Category	CMD	Hex Code CMD	Response		
				Success	Parameter	Failed
GET	Power	:01G0000	3A 30 31 47 30 30 30 30 0d	:01r0000	Backlight off	401-
				:01r0001	Backlight on	401-
				:01r0002	Power off	401-
GET	Treble	:01G1000	3A 30 31 47 31 30 30 30 0d	:01r1000 ~ :01r1100	000 ~ 100	401-
GET	Bass	:01G2000	3A 30 31 47 32 30 30 30 0d	:01r2000 ~ :01r2100	000 ~ 100	401-
GET	Balance	:01G3000	3A 30 31 47 33 30 30 30 0d	:01r3000 ~ :01r3100	000 ~ 100	401-
GET	Contrast	:01G4000	3A 30 31 47 34 30 30 30 0d	:01r4000 ~ :01r4100	000 ~ 100	401-
GET	Brightness	:01G5000	3A 30 31 47 35 30 30 30 0d	:01r5000 ~ :01r5100	000 ~ 100	401-
GET	Sharpness	:01G6000	3A 30 31 47 36 30 30 30 0d	:01r6000 ~ :01r6100	000 ~ 100	401-
GET	Sound Mode	:01G7000	3A 30 31 47 37 30 30 30 0d	:01r7001	Standard	401-
				:01r7002	Custom	401-
				:01r7003	Classroom	401-
				:01r7004	Meeting	401-
GET	Volume	:01G8000	3A 30 31 47 38 30 30 30 0d	:01r8000 ~ :01r8100	000 ~ 100	401-
GET	Mute	:01G9000	3A 30 31 47 39 30 30 30 0d	:01r9000	Off	401-
				:01r9001	On	401-
GET	Video Source	:01G:000	3A 30 31 47 3A 30 30 30 0d	:01r:000	VGA	401-
				:01r:001	HDMI1	401-
				:01r:002	HDMI2	401-
				:01r:003	AV	401-
				:01r:101	Android	401-
				:01r:103	Slot in PC	401-
GET	Aspect Ratio	:01G;000	3A 30 31 47 3B 30 30 30 0d	:01r;000	16:9	401-
				:01r;001	4:3	401-
				:01r;002	PTP	401-

ADDITIONAL INFORMATION

Type	Category	CMD	Hex Code CMD	Response		
				Success	Parameter	Failed
GET	Language	:01G<000	3A 30 31 47 3C 30 30 30 0d	:01r<000	English	401-
				:01r<001	Français	401-
				:01r<002	Español	401-
				:01r<003	Traditional Chinese	401-
				:01r<004	Simplified Chinese	401-
				:01r<005	Português	401-
				:01r<006	German	401-
				:01r<007	Dutch	401-
				:01r<008	Polish	401-
				:01r<009	Russia	401-
				:01r<010	Czech	401-
				:01r<011	Danish	401-
				:01r<012	Swedish	401-
				:01r<013	Italian	401-
				:01r<018	Turkish	401-
				:01r<019	Arabic	401-
GET	Picture Mode	:01G=000	3A 30 31 47 3D 30 30 30 0d	:01r=000	Standard	401-
				:01r=001	Bright	401-
				:01r=002	Soft	401-
				:01r=003	Customer	401-
GET	Hue (Color)	:01G>000	3A 30 31 47 3E 30 30 30 0d	:01r>000 ~ :01r>100	000 ~ 100	401-
GET	Backlight	:01G?000	3A 30 31 47 3F 30 30 30 0d	:01r?000 ~ :01r?100	000 ~ 100	401-
GET	Color Temp	:01G@000	3A 30 31 47 40 30 30 30 0d	:01r@000	Cool	401-
				:01r@001	Standard	401-
				:01r@002	Warm	401-
GET	Remote control (IR LOCK)	:01GB000	3A 30 31 47 42 30 30 30 0d	:01rB000	Disable	401-
				:01rB001	Enable	401-





ADDITIONAL INFORMATION

LED Indicator

Power LED Color & Behavior	Status
Solid Red	Standby mode
Solid Blue	Power on
Flash Red then Blue continuously	Backlight off

Troubleshooting

If you experience a problem with your device, please refer to the following information. If a problem persists, please contact your local reseller or service center.

-  *No picture or sound.*
- Make sure all signal and power connection are properly connected.
 - Make sure the correct input mode is selected. Refer to the “Selecting an Input Source” section.
 - Make sure the device is not turned off.
 - Turn off the mute function.
 - Make sure the volume is not set to the minimum level.
-  *The device is automatically shut down.*
- Check whether there is sudden power outage.
 - Make sure the power cord is not disconnected.
-  *The signal out of range*
- The signal may be incompatible. Refer to the “Supported Timing List” section.
 - For the VGA input source, try the automatic screen adjustment or adjust the **Clock** and **Phase** settings from the **Adjust** menu. Refer to the “Configure the Adjust Settings (for VGA input only)” section.
-  *The touch panel does not respond*
- Make sure the screen is not exposed to direct sunlight or other strong light.
 - For the external device connection, make sure the USB cable is properly connected to the Touch USB port of the device.
-  *If the remote control does not work*
- Check the operating angle of the remote control is pointed within $\pm 30^\circ$ to the IR receiver on the device.
 - Make sure there are not any obstructions between the remote control and the device. The distance between the remote control and the IR sensor window should not be longer than 8 meters.
 - Make sure batteries are inserted correctly and replace the batteries if they are depleted. Refer to the “Installing/Replacing the Remote Control Batteries” section.

ADDITIONAL INFORMATION

Maintenance

Proper routine maintenance can help with early fault detection and keep the device looking like new.

IMPORTANT! *Before cleaning and performing any maintenance task, make sure to unplug the power cord from the power outlet to prevent electric shock.*

Cleaning the Screen

- When the screen requires cleaning, please unplug the power cord first.
- Please use a soft, dust-free, dry cloth to wipe the screen.
- Do not use water or a spray cleaner to clean the device.
- Please contact the service center for internal cleaning of the device.

Clean the Front Frame

Use a dry, soft, lint-free cloth to wipe the front frame.



ADDITIONAL INFORMATION

Optoma Global Offices

For service or support, please contact your local office.



USA

47697 Westinghouse Drive,
Fremont, CA 94539, USA
www.optomausa.com

 888-289-6786
 510-897-8601
 services@optoma.com



Canada

47697 Westinghouse Drive,
Fremont, CA 94539, USA
www.optomausa.com

 888-289-6786
 510-897-8601
 services@optoma.com

Latin America

47697 Westinghouse Drive,
Fremont, CA 94539, USA
www.optomausa.com

 888-289-6786
 510-897-8601
 services@optoma.com



Europe

Unit 1, Network 41, Bourne End Mills,
Hemel Hempstead, Herts,
HP1 2UJ, United Kingdom
www.optoma.eu
Service Tel : +44 (0)1923 691865

 +44 (0) 1923 691 800
 +44 (0) 1923 691 888
 service@tsc-europe.com



Benelux BV

Randstad 22-123
1316 BW Almere
The Netherlands
www.optoma.nl

 +31 (0) 36 820 0252
 +31 (0) 36 548 9052



France

Bâtiment E
81-83 avenue Edouard Vaillant
92100 Boulogne Billancourt, France

 +33 1 41 46 12 20
 +33 1 41 46 94 35
 savoptoma@optoma.fr



Spain

C/ José Hierro,36 Of. 1C
28522 Rivas VaciaMadrid,
Spain

 +34 91 499 06 06
 +34 91 670 08 32



Deutschland

Wiesenstrasse 21 W
D40549 Düsseldorf,
Germany

 +49 (0) 211 506 6670
 +49 (0) 211 506 66799
 info@optoma.de

Scandinavia



Lerpeveien 25
3040 Drammen
Norway

 +47 32 98 89 90
 +47 32 98 89 99
 info@optoma.no

PO.BOX 9515
3038 Drammen
Norway

Korea

WOOMI TECH.CO.,LTD.
4F, Minu Bldg.33-14, Kangnam-Ku,
Seoul,135-815, KOREA
korea.optoma.com

 +82+2+34430004
 +82+2+34430005



Japan

東京都足立区綾瀬3-25-18
株式会社オーエス
コンタクトセンター:0120-380-495

 info@os-worldwide.com
www.os-worldwide.com



Taiwan

12F., No.213, Sec. 3, Beixin Rd.,
Xindian Dist., New Taipei City 231,
Taiwan, R.O.C.
www.optoma.com.tw

 +886-2-8911-8600
 +886-2-8911-6550
 services@optoma.com.tw
asia.optoma.com



Hong Kong

Unit A, 27/F Dragon Centre,
79 Wing Hong Street,
Cheung Sha Wan,
Kowloon, Hong Kong

 +852-2396-8968
 +852-2370-1222
www.optoma.com.hk

China

5F, No. 1205, Kaixuan Rd.,
Changning District
Shanghai, 200052, China

 +86-21-62947376
 +86-21-62947375
www.optoma.com.cn

