

datavideo



**4 CHANNEL HD/SD
HDBASET PORTABLE
VIDEO STREAMING STUDIO**

HS-1600T

Instruction Manual

www.datavideo.com

Table of Contents

FCC COMPLIANCE STATEMENT	5
WARNINGS AND PRECAUTIONS	5
WARRANTY	6
<i>STANDARD WARRANTY</i>	6
<i>THREE YEAR WARRANTY</i>	6
DISPOSAL	7
CHAPTER 1 INTRODUCTION	8
1.1 FEATURES.....	8
1.2 SYSTEM DIAGRAM	9
CHAPTER 2 CONNECTIONS AND CONTROLS	10
2.1 REAR PANEL.....	10
2.2 SWITCHER KEYBOARD PANEL.....	12
2.3 MONITOR CONTROL PANEL	19
2.4 RECORD/STREAM PANEL.....	20
CHAPTER 3 SWITCHER OSD MENU	22
3.1 START.....	22
<i>Transition Type</i>	22
<i>Transition Speed</i>	22
<i>Wipe Effect</i>	23
<i>WIPE Border Size</i>	23
<i>WIPE Border Color</i>	23
<i>BKG Color</i>	23
3.2 PIP / SPLIT	23
<i>PIP Source</i>	24
<i>PIP Size (PIP Window Size)</i>	24
<i>Position X</i>	24
<i>Position Y</i>	25
<i>Split Source</i>	25
<i>Border Size</i>	25
<i>Border Color</i>	25
3.3 PIP CROP	25
3.4 LUMAKEY.....	26
<i>Lumakey Source</i>	26
<i>Mode</i>	26
<i>Cleanup Level</i>	26
<i>Transparency</i>	26
3.5 AUDIO	27
<i>Mute</i>	27
<i>HDMI Input</i>	27
<i>HDMI Group</i>	27
<i>Level</i>	27
<i>Tally Mode</i>	27
3.6 USER MEMS.....	28

Load Memory	28
Save Memory.....	28
Factory Default.....	28
3.7 SETUP.....	28
PGM Out Res.	29
MV Out Res.....	29
Output Format.....	30
Save Setup.....	30
Language.....	30
MB and KBD Software.....	30
3.8 CAMERA.....	30
Camera CH. Setup.....	31
PTC-150T-01/02/03	31
Camera Info	31
Video	31
Operator	31
CHAPTER 4 MONITOR.....	32
4.1 MENU OPTIONS	32
MAIN ADJUST	33
COLOR	33
Information	33
Special Function.....	34
Factory Reset.....	34
4.2 FIRMWARE UPDATE PROCEDURE (MONITOR).....	34
CHAPTER 5 APPLICATIONS.....	36
5.1 PLACING A LOGO ON THE VIDEO USING THE LUMAKEY FUNCTION.....	36
5.2 CONNECTING PTC-150T CAMERAS.....	36
CHAPTER 6 VIDEO STREAMING AND RECORDING	38
6.1 STREAMING NETWORK CONNECTION AND DEVICE SEARCH	38
Connecting to a DHCP Network (DHCP Mode).....	38
Connecting to a NON-DHCP Network (Static IP)	38
Default Fixed IP	39
Troubleshooting the Network Connection	39
Advanced Troubleshooting.....	42
6.2 WEB USER INTERFACE	42
Status	43
Operation Mode	43
Stream and Record Settings	47
Storage.....	53
CG.....	55
System.....	56
File Repair.....	61
6.3 OPERATIONS	62
Video Streaming	62
RTSP/TS/HLS/SRT	62
RTMP(S)	68
Text Overlay Video.....	70

6.4	STREAM AND RECORD BUTTONS	71
	<i>Record Button</i>	71
	<i>Stream Button</i>	72
	<i>Record+Stream Button</i>	72
	<i>Bitrate Button</i>	73
	<i>Operation Mode</i>	73
6.5	RESTORING FACTORY DEFAULTS.....	74
6.6	FIRMWARE UPDATE	74
	<i>Recovery Mode</i>	75
	<i>Formatting the SD Card</i>	76
CHAPTER 7	APPENDICES	77
	APPENDIX 1 TALLY OUTPUTS	77
	APPENDIX 2 FIRMWARE UPGRADE (KEYBOARD / MAINBOARD).....	78
	APPENDIX 3 RECOMMENDED SD CARDS.....	80
	APPENDIX 4 FREQUENTLY-ASKED QUESTIONS.....	82
	APPENDIX 5 TIPS FOR ESTABLISHING AN HDBASET COMPLIANCE ENVIRONMENT AND ETHERNET CABLE SELECTION ...	83
	APPENDIX 6 DIMENSIONS	85
	APPENDIX 7 SPECIFICATIONS.....	86
SERVICE AND SUPPORT		88

Disclaimer of Product & Services

The information offered in this instruction manual is intended as a guide only. At all times, Datavideo Technologies will try to give correct, complete and suitable information. However, Datavideo Technologies cannot exclude that some information in this manual, from time to time, may not be correct or may be incomplete. This manual may contain typing errors, omissions or incorrect information. Datavideo Technologies always recommend that you double check the information in this document for accuracy before making any purchase decision or using the product. Datavideo Technologies is not responsible for any omissions or errors, or for any subsequent loss or damage caused by using the information contained within this manual. Further advice on the content of this manual or on the product can be obtained by contacting your local Datavideo Office or dealer.

FCC Compliance Statement

This device complies with part 15 of the FCC rules. Operation is subject to the following two conditions:

- (1) This device may not cause harmful interference, and
- (2) This device must accept any interference received, including interference that may cause undesired operation.

Warnings and Precautions

1. Read all of these warnings and save them for later reference.
2. Follow all warnings and instructions marked on this unit.
3. Unplug this unit from the wall outlet before cleaning. Do not use liquid or aerosol cleaners. Use a damp cloth for cleaning.
4. Do not use this unit in or near water.
5. Do not place this unit on an unstable cart, stand, or table. The unit may fall, causing serious damage.
6. Slots and openings on the cabinet top, back, and bottom are provided for ventilation. To ensure safe and reliable operation of this unit, and to protect it from overheating, do not block or cover these openings. Do not place this unit on a bed, sofa, rug, or similar surface, as the ventilation openings on the bottom of the cabinet will be blocked. This unit should never be placed near or over a heat register or radiator. This unit should not be placed in a built-in installation unless proper ventilation is provided.
7. This product should only be operated from the type of power source indicated on the marking label of the AC adapter. If you are not sure of the type of power available, consult your Datavideo dealer or your local power company.
8. Do not allow anything to rest on the power cord. Do not locate this unit where the power cord will be walked on, rolled over, or otherwise stressed.
9. If an extension cord must be used with this unit, make sure that the total of the ampere ratings on the products plugged into the extension cord do not exceed the extension cord rating.
10. Make sure that the total amperes of all the units that are plugged into a single wall outlet do not exceed 15 amperes.
11. Never push objects of any kind into this unit through the cabinet ventilation slots, as they may touch dangerous voltage points or short out parts that could result in risk of fire or electric shock. Never spill liquid of any kind onto or into this unit.
12. Except as specifically explained elsewhere in this manual, do not attempt to service this product yourself. Opening or removing covers that are marked "Do Not Remove" may expose you to dangerous voltage points or other risks, and will void your warranty. Refer all service issues to qualified service personnel.



13. Unplug this product from the wall outlet and refer to qualified service personnel under the following conditions:
 - a. When the power cord is damaged or frayed;
 - b. When liquid has spilled into the unit;
 - c. When the product has been exposed to rain or water;
 - d. When the product does not operate normally under normal operating conditions. Adjust only those controls that are covered by the operating instructions in this manual; improper adjustment of other controls may result in damage to the unit and may often require extensive work by a qualified technician to restore the unit to normal operation;
 - e. When the product has been dropped or the cabinet has been damaged;
 - f. When the product exhibits a distinct change in performance, indicating a need for service.

Warranty

Standard Warranty

- Datavideo equipment are guaranteed against any manufacturing defects for one year from the date of purchase.
- The original purchase invoice or other documentary evidence should be supplied at the time of any request for repair under warranty.
- The product warranty period begins on the purchase date. If the purchase date is unknown, the product warranty period begins on the thirtieth day after shipment from a Datavideo office.
- All non-Datavideo manufactured products (product without Datavideo logo) have only one year warranty from the date of purchase.
- Damage caused by accident, misuse, unauthorized repairs, sand, grit or water is not covered under warranty.
- Viruses and malware infections on the computer systems are not covered under warranty.
- Any errors that are caused by unauthorized third-party software installations, which are not required by our computer systems, are not covered under warranty.
- All mail or transportation costs including insurance are at the expense of the owner.
- All other claims of any nature are not covered.
- All accessories including headphones, cables, and batteries are not covered under warranty.
- Warranty only valid in the country or region of purchase.
- Your statutory rights are not affected.

Three Year Warranty

- All Datavideo products purchased after July 1st, 2017 are qualified for a free two years extension to the standard warranty, providing the product is registered with Datavideo within 30 days of purchase.



- Certain parts with limited lifetime expectancy such as LCD panels, DVD drives, Hard Drive, Solid State Drive, SD Card, USB Thumb Drive, Lighting, Camera module, PCIe Card are covered for 1 year.
- The three-year warranty must be registered on Datavideo's official website or with your local Datavideo office or one of its authorized distributors within 30 days of purchase.

Disposal

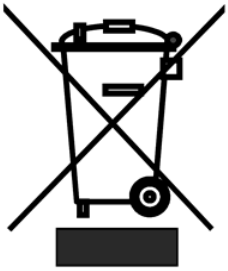

For EU Customers only - WEEE Marking

This symbol on the product or on its packaging indicates that this product must not be disposed of with your other household waste. Instead, it is your responsibility to dispose of your waste equipment by handing it over to a designated collection point for the recycling of waste electrical and electronic equipment. The separate collection and recycling of your waste equipment at the time of disposal will help to conserve natural resources and ensure that it is

recycled in a manner that protects human health and the environment. For more information about where you can drop off your waste equipment for recycling, please contact your local city office, your household waste disposal service or the shop where you purchased the product.



CE Marking is the symbol as shown on the left of this page. The letters "CE" are the abbreviation of French phrase "Conformité Européene" which literally means "European Conformity". The term initially used was "EC Mark" and it was officially replaced by "CE Marking" in the Directive 93/68/EEC in 1993. "CE

Marking" is now used in all EU official documents.

Chapter 1 Introduction

Datavideo's HS-1600T Hand-carry Mobile Switcher, the cutting-edge technology that supports **Full HD 1080P**, is designed for broadcast of live events and TV programs with a need for mixing a wide variety of video and audio sources. The HS-1600T is a highly valuable solution for **religion, education and AV markets**.

With its built-in **HDBaseT technology**, the HS-1600T is able to accept the Full HD 1080p video format from three PTC-150T HDBaseT PTZ Cameras through three individual CAT-6 cables. Each cable runs up to **100 meters**. While shooting in the field, the **PoE** feature serves to power the three PTC-150T devices. The PoE feature can also be used in the field where long-distance transmission is required.

The HS-1600T also features an **audio mixer** with balance XLR inputs and unbalance RCA audio inputs; more features include **PIP, WIPE Generator** and **Tally**.

The HS-1600T has a **Joystick** that allows the user to **Pan, Tilt** and **Zoom** the PTC-150T camera. In addition, the HS-1600T also allows the user to adjust the PTC-150T's **Focus, IRIS** and **other settings**.

HS-1600T also features an easy-to-use video **streaming** and **recording** device for professional video producers who need to simultaneously stream a live event and record the master quality version for post-event editing.

1.1 Features

- Full HD 1080P Video Format
- Built-in HDBaseT technology to connect three PTC-150T HDBaseT PTZ Cameras through three CAT-6 (or higher) cables with each cable running up to 100 meters.
- PoE technology to Power the PTC-150Ts
- Joystick Pan, Tilt and Zoom with speed control
- Iris, Focus, and Gain Control as well as other PTC-150T camera functions
- Simultaneous Live Streaming & Recording
- Broadcast quality HD / SD H.264 network streaming over RTMP(S), RTSP, TS, HLS and SRT
- Support different bitrates for recording and streaming
- 4 Video Inputs (RJ-45 x 3 + HDMI x 1)
- 3 Video Outputs (HDMI x 3)
- Audio inputs: XLR Analogue x 2 + RCA Analogue (L/R) x 2
- Versatile Mix Effects: PIP, WIPE, Mix and Fades
- Tally Output
- One 17.3-inch monitor with a resolution of 1920x1080

1.2 System Diagram

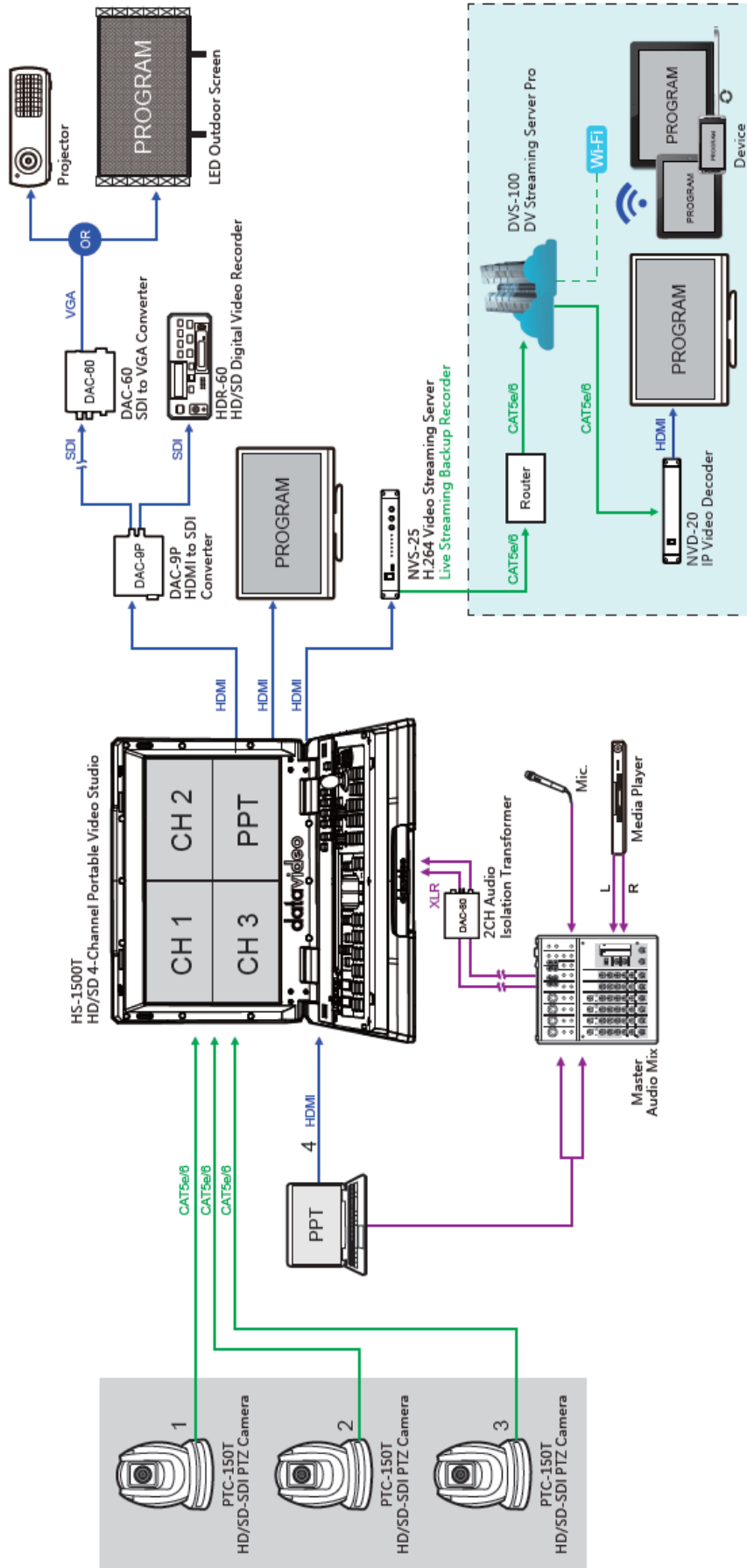

Chapter 2 Connections and Controls

2.1 Rear Panel

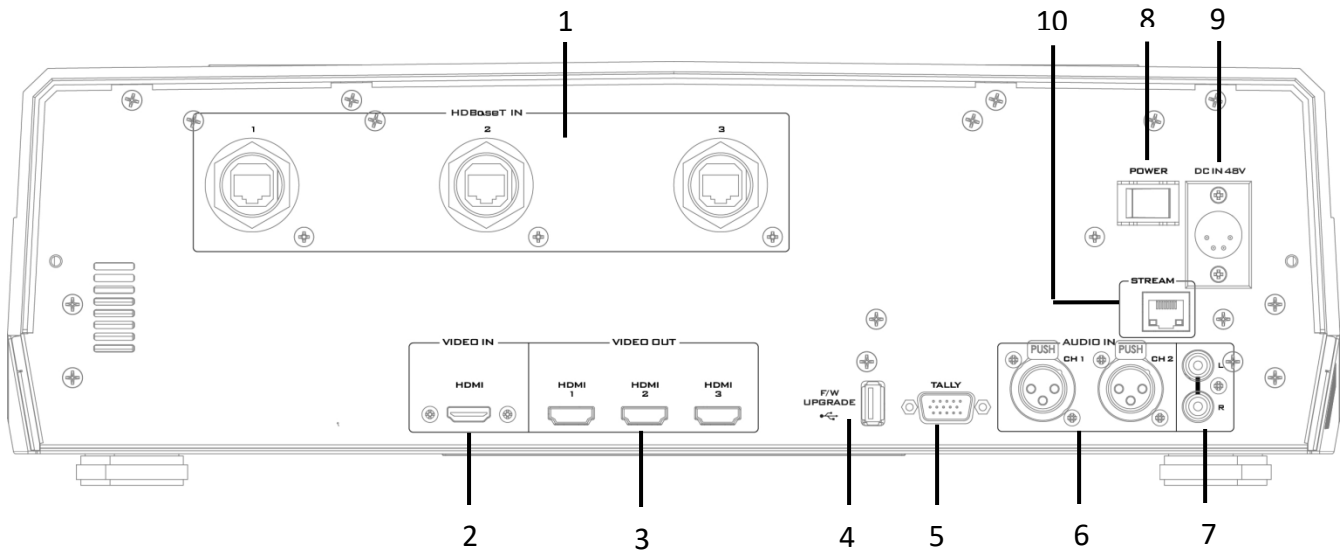

- | | |
|------------------------|---|
| 1 HDBaseT Port x 3 | 6 MIC IN – CH1/CH2 |
| 2 HDMI Video IN | 7 Audio Input – Stereo RCA (Left/Right) |
| 3 HDMI Video OUT x 3 | 8 DC IN |
| 4 USB F/W Upgrade Port | 9 Power Switch |
| 5 TALLY Output Port | 10 Stream Port |

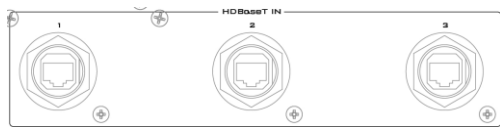

1. HDBaseT IN

The HDBaseT ports connect three HDBaseT cameras via three CAT-6 Ethernet cables. Please note that the baud rate is 38400 which cannot be changed by the user. Hence, in order to establish connection with the camera, you will also need to set the camera's baud rate to 38400 as well. See [Section 5.2](#) for setting of the baud rate on the connected cameras.

After the cameras are physically connected to the HDBaseT ports, and the baud rate is set to 38400 on the camera ends, the camera videos will appear on the respective Multiview quadrants.



Note: The HDBaseT port is a specially designed port with an outer fastening ring allowing the user to secure the Ethernet cable connection. In the product package, three additional Ethernet cable connectors are provided for the user to make your own cable for your production environment.

HDMI



2. HDMI Video Input

The HDMI Video Input port connects an additional video source device and the video will be displayed on the fourth quadrant.

HDMI
1



HDMI
2



HDMI
3



3. HDMI Video Output 1 – 3

Connect to a monitor for Program OUT display or other HDMI destination devices.

F/W
UPGRADE



4. USB F/W Upgrade Port

USB port for firmware upgrade. Please refer to the [Firmware Upgrade](#) section for details.

TALLY

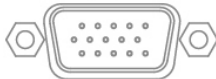

5. TALLY Output Port

Sends **Red** and **Green** tally signals to each channel.

Red indicates On-Air, and **Green** indicates next camera source. Tally output port can connect other Datavideo peripheral devices such as ITC-100, ITC-200, AM-100 or other monitor models, allowing the peripheral device to communicate with the HS-1600T or send tally signal to be displayed on the monitor.

See [Appendix 1](#) for physical pin connections and [Section 3.5](#) for [Tally Mode](#) selection.

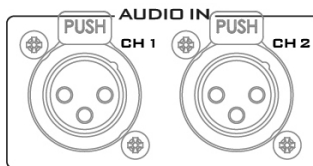

6. Audio Input – XLR Balanced (CH1/CH2)

Two channels of XLR Balanced Audio Input.

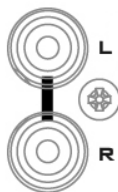

7. Audio Input – Stereo RCA (Left/Right)

Connects unbalanced analog audio source (stereo).

POWER

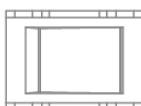

8. Power Switch

Power switch ON/OFF

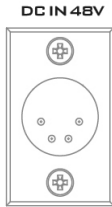

9. DC IN

DC in socket connects the supplied 48V / 190W PSU. The connection can be secured by screwing the outer fastening ring of the DC In plug to the socket.

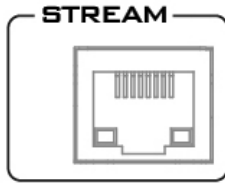

10. Stream Port

The stream port allows the user to establish direct connection between the notebook computer and the HS-1600T in order to access the built-in NVS-31 or connect the NVS-31 to any local area network.

Note: See the [Chapter 6 Video Streaming](#) for device configuration.

2.2 Switcher Keyboard Panel

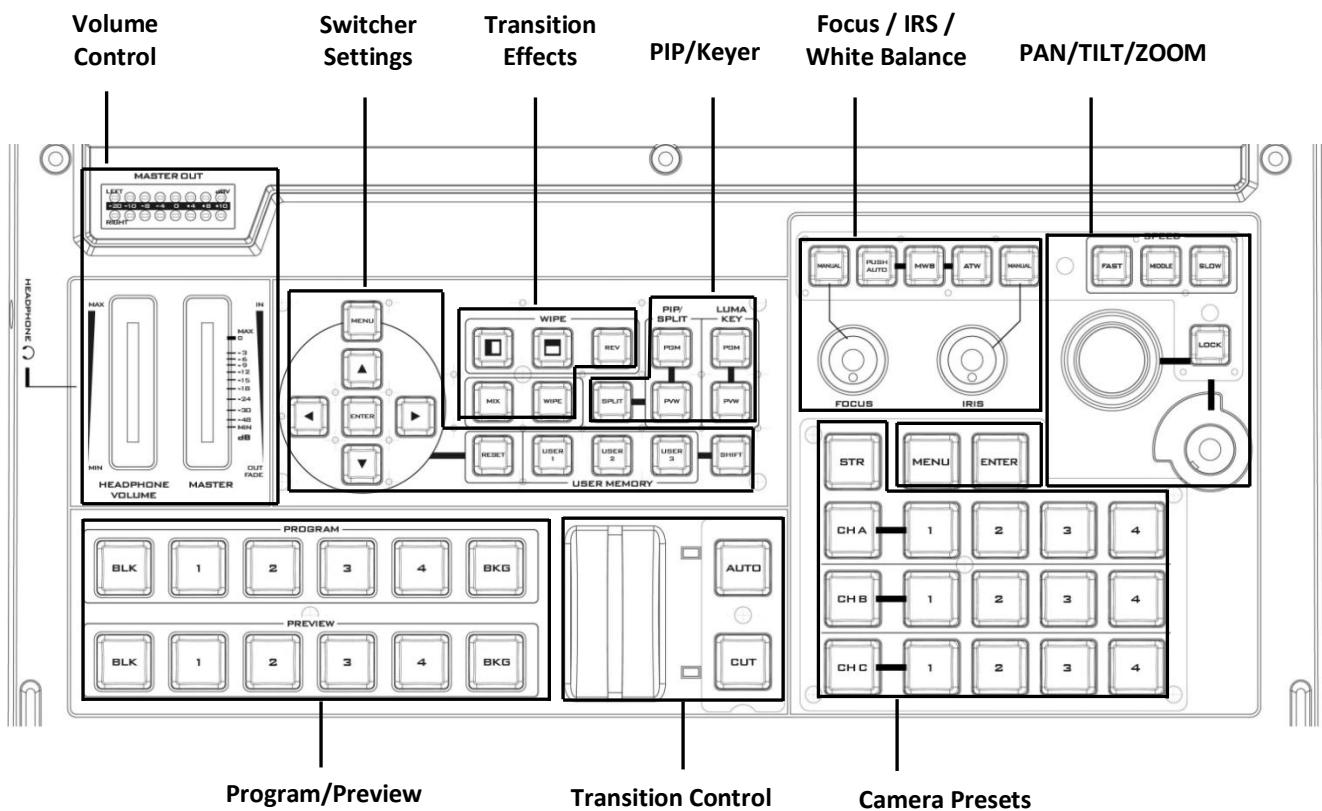

Switcher Settings

- Menu browsing buttons
- RESET button
- User Memory
- Shift button

Volume Control

- Volume adjustment sliders
- Headphone jack
- Audio meter
- Headphone volume control knob

Transition Effects

- WIPE transition effect selection
- MIX Enable/Disable button

Camera Presets

- Channel Selection Buttons
- Preset Buttons

WIPE transition effect Enable/Disable	STR Button
PIP/Keyer	FOCUS / IRIS / White Balance
Enable/Disable buttons for PIP Keyer	Focus Adjustment
Luma Keyer Enable/Disable buttons	IRIS Adjustment
Split Activation button	White Balance
Transition Control	PAN / TILT / ZOOM
T-Bar (manual transition)	Speed Selection Buttons
CUT button	Joystick – PAN/TILT
AUTO transition button	VR Knob – ZOOM
Program/Preview	LOCK Button
Program row	Camera MENU Control
Preview row	MENU Button
	ENTER Button

Switcher Settings

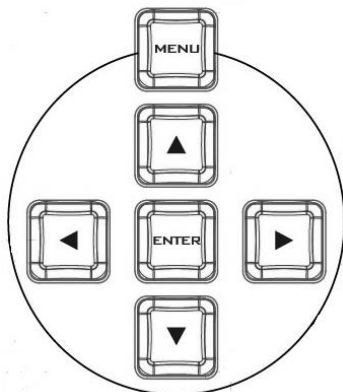

Menu browsing buttons

Press the **MENU** button to gain access to the menu; use the up/down/left/right **arrow buttons** to browse through the menu and press **ENTER** button to select an option or **MENU** button again to exit.

Reset Button

Mode 1 – When in Menu Select mode (left hand column of the OSD menu), pressing the 'Reset' button will reset all current menu items to their factory defaults.

Mode 2 – When in a Sub-Menu, pressing the 'Reset' button will reset the current menu line only.

User Memory

User Memory buttons 1-3 allow the user to quickly recall and load previously saved switcher settings with a single button press. This includes PIP and Keyer settings. See the [User Memory](#) section for setup information.

Shift Button

Pressing the **Shift** button will switch **USER 1-3** buttons to **USER 4-6** buttons

Transition Effects

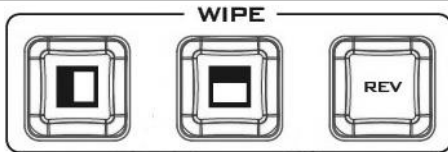

WIPE Transition Effect Selection

Each Wipe button consists of black and white colors. The white represents the current **Program** image and the black represents the **WIPE-IN** image. The HS-1600T provides 3 WIPE presets with the **Horizontal** and **Vertical** WIPEs selectable on the control panel. The **Center** WIPE can be selected from the menu ([Start](#)).

Pressing the **REV** button reverses the direction of the **WIPE**.



MIX Enable/Disable Button

A **MIX**, also known as a dissolve, is a transition wherein the Program video is replaced by the Preview video at a smooth rate, and at the same time. Pressing the **MIX** button enables the **MIX** transition effect and automatically disables the **WIPE** button. To trigger the **MIX** effect, simply press the **AUTO** button or move the **T-Bar**.



WIPE Transition Effect Enable/Disable Button

Pressing the **WIPE** button enables the **WIPE** transition effect after which the **WIPE** transition effect can be selected. To trigger the **WIPE** transition effect, simply press the **AUTO** button or move the **T-Bar**.

Wipe Transition Effect, Border and **Position** settings can be found in the OSD menu ([Start](#)).

PIP / Keyer



Enable/Disable Buttons for PIP Keyer

Picture in Picture puts the selected Sub Video Source in a window on the Main Program view, with control over window size and placement. For PIP configuration, please refer to the [PIP](#) section.

PIP PGM: Shows the configured PIP on the PGM output after transition, however, the PIP cannot be previewed on the QUAD split view display.

PIP PVW: Sets the configured PIP on the next transition. Holding down this button allows selection of the PIP source from the Preview Source row. The selected source button will flash.

LUMA KEY



Luma Keyer Enable/Disable Buttons

Luma Key PGM: Shows the luma key source on the PGM output and enables the luma key effect, however, the luma key effect cannot be previewed on the QUAD split view display.

Luma Key PVW: Enables luma key source for the PGM output on the next transition. Holding down this button allows selection of the luma key source from the Preview Source row. The selected source button will flash.

See [Section 3.4](#), the [Luma Key](#) section, for luma key configurations.

Split Activation Button

After activating the PIP window, pressing the **Split** button will split the PROGRAM output display into two with the program out view on the left and the PIP view on the right.

To select the Split source, i.e. the program out view, please see [Split Source](#) in [Section 3.2](#).

Transition Control

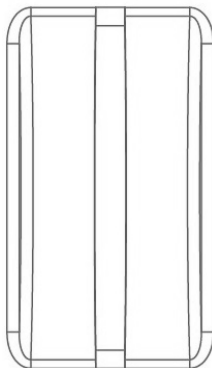

T-Bar (Manual Transition)

T-Bar is used for manual transition. The **T-Bar** can be either all the way up, all the way down or anywhere in between. When the T-Bar is pushed to halfway between the topmost position and the bottommost position, the keyboard functions will be disabled.

PVW and **PGM** views can be transitioned at your preferred speed. To include the transition effect, simply press the **WIPE** or **MIX** button, after which the **Transition Effect** will be triggered as you move the **T-Bar**.



CUT Button

Pressing the **Cut** button performs immediate manual switch between PVW and PGM views without the transition effect.



AUTO Button

Pressing the **Auto** button automatically transitions **PVW** and **PGM** views according to the selected speed and the configured transition effect.

Program Output

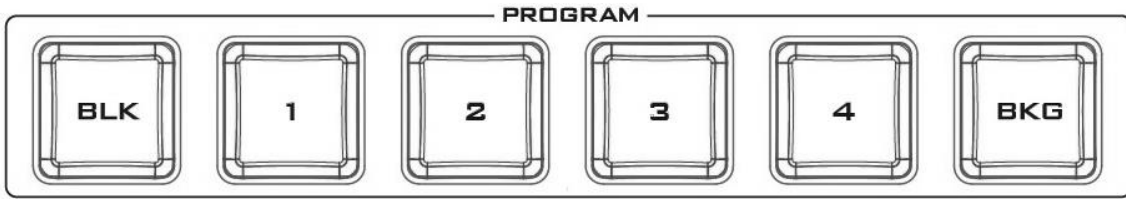

Program Source Row

Pressing the number buttons along the **PROGRAM** row selects a video source for the **PGM** view.

BKG button: Pressing the **BKG** button will switch the background to a **Matte** background. The BKG color can be configured on the OSD MENU ([Start](#) → [BKG Color](#)) and the available color options are listed as follows:

- White
- Yellow
- Cyan
- Green
- Magenta
- Red
- Blue
- Black

BLK button: Pressing the **BLK** button places a black screen on the **PROGRAM** view.

Preview Output

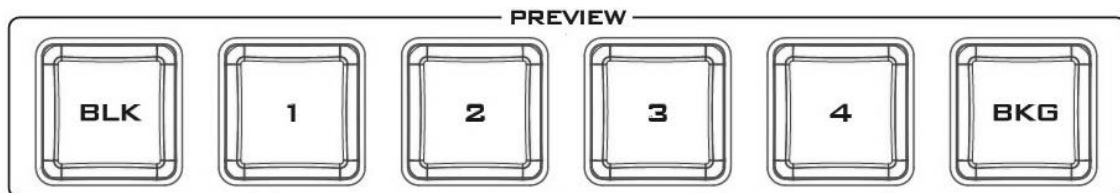

Preview Source Row

Pressing the number buttons along the **PREVIEW** row selects a video source.

BKG button: Pressing the **BKG** button will set the Preview OUT to a **Matte** background, which will be displayed on the **Program OUT** monitor upon the next transition. The BKG color can be configured on the OSD MENU ([Start](#) → [BKG Color](#)) and the available color options are listed as follows:

- White
- Yellow
- Cyan
- Green
- Magenta
- Red
- Blue
- Black

BLK button: Pressing the **BLK** button sets the **Preview** OUT to a black screen.

Volume Control

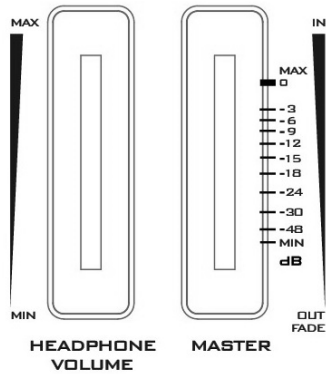

Volume Adjustment Sliders

Sliders to control audio levels for the Main audio mixer.

Headphone Volume: Audio volume of the connected headphone.

Master: Main audio output volume.



Headphone Jack

Headphone jack accepts the mini jack plug of the stereo headphone type. The headphone volume is controlled by the Headphone volume adjustment slider.

MASTER OUT

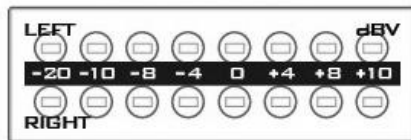

MASTER OUT Meter

The LED style meters show the audio signal strength at the Main Program Audio Output. The signal strength is determined by the level set with the Master OUT slider. The LEDs turn red at +10 dB to indicate clipping distortion.

Audio Volume (dBV)	-20		-10		-8		-4		0		+4		+8		+10	
LED Color	G		G		G		G		G		Y		Y		R	
Range (dBV)	-20	-12	-11	-9.5	-8.5	-6.5	-5.5	-3	-2	1	2	5.5	6.5	8	9+	

G: Green Y: Yellow R: Red

Camera Presets



Channel Selection Buttons

To control or set up a connected camera, first select it by pressing these buttons. The selected channel button will be turned ON.

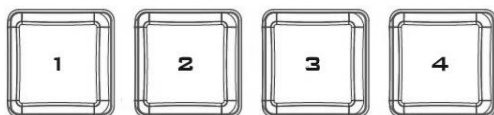

Preset Buttons

These buttons may be used to store up to four camera positions for each camera. Each button corresponds to one stored camera position. The button LED will be turned ON when selected.



STR Button

Pressing this button enters the HS-1600T into **STORE MODE**. When activated, this allows the current camera position to be stored in a chosen Channel Preset Button by pressing the corresponding preset button.

Press again to exit **STORE MODE**.

FOCUS / IRIS / White Balance

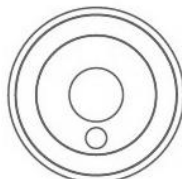

FOCUS

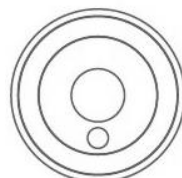

IRIS



Focus Adjustment

To manually control the **FOCUS** setting, first press the **MANUAL** button to enter the manual mode. The button LED will be turned ON to indicate that the manual mode is enabled.

The **FOCUS** dial can then be rotated to set the focus.

If the **MANUAL** button is disabled (OFF), the camera is in **AUTO FOCUS** mode.

IRIS Adjustment

To manually control the **IRIS** setting, first press the **MANUAL** button to enter the manual mode. The button LED will be turned ON to indicate that the manual mode is enabled.

The **IRIS** dial can then be rotated to set the exposure.

If the **MANUAL** button is disabled (OFF), the camera is in **AUTO IRIS** mode.

White Balance

Push Auto

Push once to automatically adjust the camera white balance setting.

MWB (Manual White Balance)

Push to enable manual white balance setting.

ATW (Force Automatic White Balance)

Push to enable automatic white balance setting.

PAN / TILT / ZOOM

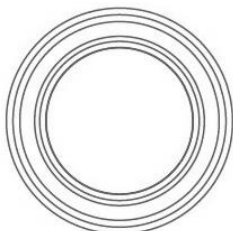
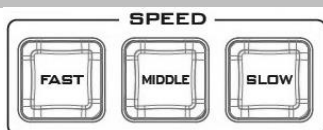

Speed Selection Buttons

The speed at which the selected camera moves can be chosen by pressing one of the three speed buttons.

Joystick – PAN / TILT

PAN – Move the joystick left or right to pan the selected PTZ camera from left to right or vice versa.

TILT – Move the joystick up or down to tilt the selected PTZ camera up or down.

Note: Before attempting to use the joystick to PAN or TILT a selected camera, first make sure the **LOCK** button is not enabled. If the **LOCK** button LED is ON, the joystick is locked; press the **LOCK** button to unlock the joystick.



VR Knob – ZOOM

ZOOM – Twist the joystick clockwise (to the right) or anti-clockwise (to the left) to have the selected PTZ camera zoom in or out.

Note: Make sure the **LOCK** button is not enabled. If the **LOCK** button LED is ON, the joystick is locked; press the **LOCK** button to unlock the joystick.



LOCK Button

When enabled, the joystick will be in the lock state. To resume its functional status, simply press the button once to unlock the joystick.

Camera MENU Control



MENU Button

Press once to open the **OSD MENU** of the connected PTC-150T on the monitor screen. Use the **P/T** joystick to move between options. To select, simply press the **ENTER** button. Please see the **PTC-150T instruction manual** for details of the menu operation.

Note: Pressing the menu button again will not exit the **OSD MENU**. Select the **ESCAPE** option on the **OSD MENU** to exit.



ENTER Button

Press this button to select a menu option after the camera OSD menu is opened.

2.3 Monitor Control Panel



Power

Switches the HS-1600T Monitor Power ON / OFF



BLUE

Press this button to eliminate the red and green component of input signals. Only the blue component of an input is displayed on the screen. This allows adjustments of chroma and phase. (Phase adjustment is effective with NTSC signals).



PTN

When pressed displays internally generated SMPTE 75% Colour Bars. Press again to return to the previously selected video input.



ZOOM

This feature is designed for use with HD-SDI and HDMI sources above 720p resolution. Press this button to zoom in to the video on the display. This is strictly a zooming function and does not alter the native aspect ratio of the source pixels to fill the screen.

The **ZOOM** button allows you to toggle the Pixel Zoom feature between **zoom x1, x2, x4** and **x8**.



Menu Navigation Buttons

Display and navigate the setup menus. See [Monitor Menu Options](#) for more details.



Aspect Ratio Button

Sets the Aspect Ratio to 16:9 / 4:3

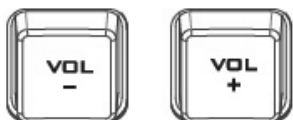

Volume Control

Adjusts the speaker / headphone volume up / down.

MUTE

Mutes the audio from the internal speakers or headphone socket.

2.4 Record/Stream Panel

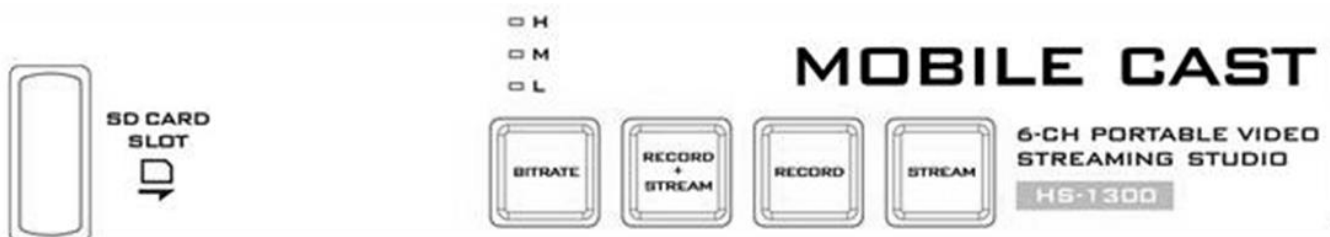



RECORD

Press the **RECORD** button to start enable video record mode. See [section 6.4](#) for details.



STREAM

Press the **STREAM** button to enable video stream mode. See [section 6.4](#) for details.



RECORD + STREAM

Press the **RECORD + STREAM** button to enable video record and stream modes at the same time. See [section 6.4](#) for details.

Note: Not all models come with the Record+Stream button.



BITRATE

Use the **BITRATE** button to switch between **high (H)**, **moderate (M)** and **low (L)** bitrates for each of the **RECORD**, **STREAM** and **RECORD+STREAM** buttons. See [section 6.4](#) for details.

Note: Not all models come with the bitrate button.



SD Card Slot

Insert an SD card into the SD card slot for video recording.

Note that you should only use Class 10 SD card or above. See the Appendix, Recommended SD Cards, for a list of SD cards recommended by Datavideo.

Note: Do not remove SD card while it is being written as doing so may result in corrupted video files.

Chapter 3 Switcher OSD Menu

The switcher's OSD menu allows the user to perform several configurations of video effects, such as picture-in-picture, luma key and etc. The user can also configure the audio settings in the Audio menu. In the setup menu, the user is allowed to set video output resolution, reset to factory default, and selects the interface language.

3.1 Start

Option	Parameters	Parameter Value or Range	Default Value
Start	Transition Type	MIX WIPE	Mix
	Transition Speed	1-200 frames	60 frames; the duration in second depends on the Program OUT resolution.
	WIPE Effect	1. Horizontal 2. Vertical 3. Center	1
	WIPE Border Size	OFF Small Middle Large	Small
	WIPE Border Color	White Yellow Cyan Green Magenta Red Blue Black	Red
	BKG Color	White Yellow Cyan Green Magenta Red Blue Black	White

Transition Type

The HS-1600T provides two types of transition effect, which are cross dissolve (MIX) and WIPE. The default setting is **MIX**.

Transition Speed

The **Transition Speed** allows the user to set the **MIX** or **WIPE** effect duration, in frames. If the **Transition Speed** is set to a value of 60 then the transition will take effect over a period of 1 second if the progressive video is chosen and 2 seconds if the interlaced video is chosen. When the **AUTO** button is pressed, the transition will take the current **Transition Speed** defined by the user.

Note: Pressing the left or right arrow button on the control panel allows the user to either decrement or increment Position X by 1. To change the parameter value at an accelerated rate, simply press and hold the left or right arrow button.

Wipe Effect

On the HS-1600T, there are three wipe effects available for the user to choose. The three wipe effects are **HORIZONTAL**, **VERTICAL** and **CENTER**. The default is Horizontal.

WIPE Border Size

The **WIPE Border Size** generally allows the user to select an appropriate border width. Setting the **WIPE Border Size** to OFF turns the border off. Setting this parameter to small selects a thin border; middle will yield a medium size width; large is the maximum wipe border width.

WIPE Border Color

In this option, you will be allowed to select a color for your wipe border. The available colors are listed as follows:

- White
- Yellow
- Cyan
- Green
- Magenta
- Red
- Blue
- Black

BKG Color

In this option, you will be allowed to assign a color to the **BKG** button. The available colors are listed as follows:

- White
- Yellow
- Cyan
- Green
- Magenta
- Red
- Blue
- Black

3.2 PIP / Split

Picture-In-Picture (P-In-P) places a sub window on the **PGM** or **Multiview** screen. This option (**PIP/Split**) allows you to configure various parameters of the PIP window.

Note: When PIP and Lumakey features are enabled at the same time, the lumakey source will be the upper layer and the PIP source will be the lower layer. The layer order cannot be changed.

Option	Parameters	Parameter Value or Range	Default Value
PIP/Split	PIP Source	Black Input 1 Input 2	Input 2

		Input 3 Input 4* Background Color Bar	
	PIP Size	1-100%	30%
	Position X	-50% - +50%	20%
	Position Y	-50% - +50%	10%
	Split Source	Black Input 1 Input 2 Input 3 Input 4* Background Color Bar	Input 2
	Border Size	OFF Small Middle Large	Small
	Border Color	White Yellow Cyan Green Magenta Red Blue Black	Red

PIP Source

In this option, the user will be allowed to assign the PIP source; the available sources are listed as follows:

- Black
- Input 1
- Input 2
- Input 3
- **Input 4***
- Background
- Color Bar

Tip: To quickly assign the PIP source, simply press and hold the PIP PGM button and then select a source from the Program BUS.

PIP Size (PIP Window Size)

The PIP Size parameter ranges from 1 to 100 with 1% being the smallest and 100 being the largest. Therefore 50% would represent a PIP window which is half the size of the background image. 100% would see the PIP window totally cover the background image unless offset to one side.

Position X

Adjusting **Position X** parameter moves the PIP window horizontally. Pressing the left or right arrow button on the control panel allows the user to either decrement or increment **Position X** by 1. To

change the parameter value at an accelerated rate, simply press and hold the left or right arrow button.

Position Y

Adjusting **Position Y** parameter moves the PIP window vertically. Pressing the up or down arrow button allows the user to either increment or decrement **Position Y** by 10. Press and hold the up and down arrow buttons to change the parameter value at an accelerated rate.

Split Source

After the PIP window is activated, pressing the Split button will split the PROGRAM output display into two with the program out view on the left and the PIP view on the right. The Split source, i.e. the program out view, can be selected in this option. The available split sources are listed as follows:

- Black
- Input 1
- Input 2
- Input 3
- **Input 4***
- Background
- Color Bar

Border Size

The **Border Size** generally allows the user to select an appropriate PIP border width. Setting the **Border Size** to OFF turns the PIP border off. Setting this parameter to small selects a thin border; middle will yield a medium size width; large is the maximum PIP border width.

Border Color

The user is allowed to assign a PIP border color. The available colors are listed as follows:

- White
- Yellow
- Cyan
- Green
- Magenta
- Red
- Blue
- Black

***Note: Select Input 4 if you would like to use the video source connected to the HDMI input.**

3.3 PIP Crop

The PIP Crop basically adjusts the PIP window borders. You can adjust each side individually (Left / Right / Top / Bottom) or all four sides at the same time (Size).

Option	Parameters	Parameter Value or Range	Default Value
PIP Crop	Size	0 – 100%	0
	Left	0 – 100%	0
	Right	0 – 100%	0
	Top	0 – 100%	0
	Bottom	0 – 100%	0

The effects of all parameters are described below:

- **Left** – Adjusts the position of the left edge of the PIP window.
- **Right** – Adjusts the position of the right edge of the PIP window.
- **Size** – Adjusts the PIP image crop size.
- **Top** – Adjusts the position of the top edge of the PIP window.
- **Bot** – Adjusts the position of the bottom edge of the PIP window.

3.4 Lumakey

Keyer of the HS-1600T provides the user with the capability of luma keying.

Note: When PIP and Lumakey features are enabled at the same time, the lumakey source will be the upper layer and the PIP source will be the lower layer. The layer order cannot be changed.

Option	Parameters	Parameter Value or Range	Default Value
Lumakey	Lumakey Source	Black Input 1 Input 2 Input 3 Input 4* Background Color Bar	Input 2
	Mode	Black White	Black
	Cleanup Level	0 – 100	20
	Transparency	0 – 64	64

Lumakey Source

Lumakey source is where you can select the image for luma keying. The available sources are listed as follows:

- Black
- Input 1
- Input 2
- Input 3
- **Input 4***
- Background
- Color Bar

Mode

There are two modes available on the Luma Keyer. Select Black if the image is on a black background and white if the image is on a white background.

Cleanup Level

The **Cleanup Level** allows the user to fine tune the effect of the luma key. The default value is 20.

Transparency

In this option, you will be able to adjust the transparency of the overall foreground key image.

***Note: Select Input 4 if you would like to use the video source connected to the HDMI input.**

3.5 Audio

This option allows the user to configure various audio settings such as muting HDMI output audio, set the audio type, selecting your tally type and etc.

Option	Parameters	Parameter Value or Range	Default Value
Audio	Mute	OFF/ON	Off
	HDMI Input	Input 1-4 / Follow	Follow
	HDMI Group	Channel 1/2 Channel 3/4 Channel 5/6 Channel 7/8	Channel 1/2
	Level	Auto / SMPTE / EBU	Auto
	Tally Mode	Normal / Audio Mixer	Normal

Mute

The **Mute** allows you to turn ON/OFF the embedded audio component at the **HDMI-in**. The default is OFF.

HDMI Input

In this option, you can select the audio source. Selection of input 1-4 allows the HS-1600T to play the enabled audio source. If “**Follow**” is selected, the audio will enter Audio follow Video mode, i.e. playback of the audio of the output video.

HDMI Group

The HDMI Group allows the user to assign the HDMI audio channel. The default audio channel is Channel 1/2. Any audio channel pair of the four audio channel pairs can be selected.

Level

There are two different audio standards available for selection. The user can either select the EBU or SMPTE standard. By selecting AUTO allows the device to automatically detect the audio standard. When the image is 50 Hz, the audio follows EBU standard and when the image is 59.94/60 Hz, the audio follows SMPTE standard.

Tally Mode

Tally output port generally sends two tally signals to each channel. In Datavideo products, **Red** indicates On-Air, and **Green** indicates next camera source.

The HS-1600T provides **two tally modes**:

Normal: If in normal mode, tally lights of all camera sources displayed on the PGM monitor will be turned ON (Red). These sources include PGM, PIP and Key sources. While the transition is in progress, as the next video is seen on the PGM monitor, tally light of the PVW source camera will thus also be turned ON (**Red**).

Audio Mixer: If the Audio Mixer mode is selected, only tally light of the PGM source camera selected on the keyboard panel will be turned ON (Red). While the transition is in progress, the tally light color will remain unchanged. The tally light color will only change (red → green) after the transition of PGM and PVW views is complete.

3.6 User Mems

In “User Mems”, the user is allowed to **load** previously saved settings and **save** the currently configured settings.

Option	Parameters	Parameter Value or Range	Default Value
User Mems	Load Memory	User 1-6	
	Load		
	Save Memory	User 1-6	
	Save		
	Factory Default	[Reset]	

Load Memory

Use the up/down arrow to select the desired memory location and load the saved setting by selecting “Load”.

Tip: The user can also press one of the USER memory shortcut buttons (1-3) on the control panel as a quick way of loading those previously saved User configurations. Use the **SHIFT** button to switch between **USER MEMORY 1-3** and **USER MEMORY 4-6**.

Save Memory

Use the up/down arrow to select the desired memory location and save the current setting by selecting “Save”.

Factory Default

Reset: Once selected, the factory default settings will be restored. The device will start the factory reset process in 2 to 3 seconds after “Reset” is selected.

3.7 Setup

In the “Setup” menu, the user can change the **output resolution**, reset the HS-1600T to its **Factory Default** values, choose the preferred OSD menu **language**, **upgrade firmware** and view the **current firmware versions** (Mainboard and Keyboard).

Option	Parameters	Parameter Value or Range	Default Value
Setup	PGM Out Res.	1080p/60 1080p/59.94 1080p/50 1080i/60 1080i/59.94 1080i/50 720p/60 720p/59.94 720p/50 576i 480i	
	MV Out Res.	1080p/60 1080p/59.94 1080p/50 1080i/60 1080i/59.94	

		1080i/50 720p/60 720p/59.94 720p/50	
	Output Format	RGB YUV444 YUV422	
	Save Setup	[Save]	
	Language	English Simplified Chinese Traditional Chinese	
	MB Software	Version	
	KBD Software	Version	

PGM Out Res.

In **PGM Out RES.**, the user is allowed to select an appropriate PROGRAM output resolution. The available resolutions are listed as follows:

- 1080p/60
- 1080p/59.94
- 1080p/50
- 1080i/60
- 1080i/59.94
- 1080i/50
- 720p/60
- 720p/59.94
- 720p/50
- 576i
- 480i

Once done, simply go to “**Save Setup**” to confirm the selected output resolution.

Note: Please make sure the output resolution is same as the input resolution to prevent unexpected issues.

MV Out Res.

In **MV Out RES.**, the user is allowed to select an appropriate MULTIVIEW output resolution. The available resolutions are listed as follows:

- 1080p/60
- 1080p/59.94
- 1080p/50
- 1080i/60
- 1080i/59.94
- 1080i/50
- 720p/60
- 720p/59.94
- 720p/50

Once done, simply go to “**Save Setup**” to confirm the selected output resolution.

Note: The new resolution will be effective once selected. If you have selected a resolution that is not supported by the monitor, you will not be able to view the OSD menu. In this case, please reboot your machine to restore the default resolution previously configured in the “Save Setup” option.

Output Format

Select a color encoding system for your video output. The available output color formats are listed as follows:

- RGB
- YUV444
- YUV422

Save Setup

In this option, select “**Save**” to save the current configuration.

Language

The available OSD menu languages are **English, Traditional Chinese** and **Simplified Chinese**.

MB and KBD Software

The **MB** and **KBD** software fields display the respective version numbers.

3.8 Camera

In the “**Camera**” menu, the user will be able to change the camera name, view camera information and perform some basic camera settings. The basic camera settings include the video format, mirror mode, PAN/TILT direction and etc.

Option	Sub-options	Parameters	Parameter Value or Range	
Camera	Camera CH. Setup	Yes/No		
	[PTC-150T-01/02/03]	Camera Info	Vendor ID	
			MB Version	
			FPGA Version	
			Motor Version	
			DVIP Version	
	Video	Video Format	1080i/60	
			1080i/50	
			1080p/29.97	
			1080p/25	
		720p/59.94		
		720p/50		
		1080p/59.94		
		1080p/50		
	Mirror Mode	Off		
		V		
		H		
		H+V		
	Joystick Pan	Normal		
		Reverse		

			Joystick Tilt	Normal Reverse
			Memory Speed	1-18
		Operator	Power	On/Standby
			R-Gain	0-255
			B-Gain	0-255
			Tally LED	Off Red Green

Camera CH. Setup

By selecting Yes/No, you will be able to enable/disable the camera setup.

PTC-150T-01/02/03

The PTC-150T-01/02/03 options will allow you to configure basic settings of the respective cameras.

Camera Info

This field provides camera information display such as **Vendor ID**, **MB Version**, **FPGA Version**, **Motor Version** and **DVIP Version**.

Video

In the "Video" sub-option, you will be able to configure the **Video Format**, **Mirror Mode**, **Joystick Direction** and **Joystick Speed**.

The available resolutions in the **Video Format** parameter are listed as follows:

- 1080i/60/50
- 1080p/59.94/50/29.97/25
- 720p/59.94/50

In "**Mirror Mode**", there are three types of modes available:

- V: Vertical mirroring
- H: Horizontal mirroring
- H+V: Horizontal and Vertical mirroring

In **Joystick Pan/Tilt**, you can either select the normal PAN/TILT direction or reverse the PAN/TILT direction. The PAN/TILT speed can be configured in **Memory Speed**, which ranges from 1-18.

Operator

The **Operator** sub-option offers the user basic camera operation functions. Parameters of this sub-option are described below:

Power: Select **ON** to start powering the selected camera; selection of **Standby** enters the camera into power standby mode.

R-Gain/B-Gain: The red and blue components can be adjusted, ranging from 0 to 255.

Tally LED: You can either turn the tally light off or enable the red or green tally light.

Chapter 4 Monitor

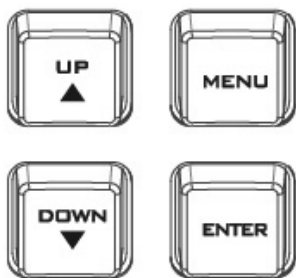

The HS-1600T's built-in monitor can be configured via an on screen menu. Press the **MENU** button to display the Main Menu list on the monitor.

This section covers the Menu options in the order that they appear on the monitor. These settings may also appear in more detail elsewhere in this instruction manual. Options may vary depending on the firmware version in use.

Once the chosen setting has been confirmed with the **ENTER** button, it is stored within the switcher's non-volatile memory.

4.1 MENU Options

Main Options	Sub Options	Parameters	Parameters
MAIN ADJUST	BRIGHTNESS	0~100	
	CONTRAST	0~100	
	SHARPNESS	0~100	
	SATURATION	0~100	
	TINT	0~100	
	BACKLIGHT	0~100	
	NR	HIGH / MID / LOW / OFF	
	DLC	ENABLE / DISABLE	
	VOLUME	0~100	
	EXIT		
COLOR	6500		
	9300		
	7500		
	USER COLOR	RED	0~100
		GREEN	0~100
		BLUE	0~100
EXIT			
SCAN SETTING	UNDER SCAN	Full Image	
	OVER SCAN	Cropped Image	
INFORMATION	H. FREQUENCY		
	V. FREQUENCY		
	RESOLUTION		
	VER.		
LANGUAGE	English [default]		
	Francis		
	Deutsch		
	Español		
	Italiano		
	Dutch		
	Português		
	Russian		
EXIT			

SPECIAL FUNCTION	OSD TIMOUT	5-120 SEC	
	FRAME RATIO	80 / 90 / OFF	
	4:3 MARK LINE	ON / OFF	
	CENTRAL MARK	ON / OFF	
	CINEMA ZONE MARK	ON / OFF	
	AUDIO CHANNEL L*		
	AUDIO CHANNEL R*		
	EXIT		
FACTORY RESET			
EXIT			

* Selectable on PGM only; external HDMI and MV are allowed on 1 and 2 ONLY.

MAIN ADJUST

After pressing the **MENU** button on the monitor control panel, the first menu option highlighted is the **MAIN ADJUST** option.

Press **ENTER** to access the **MAIN ADJUST** Menu and the **Brightness** option will be highlighted.

To adjust the **Brightness**, press **Enter** again. Use the **Up / Down** buttons to change the value and then press **Enter** to store the new value and return to the main menu.

To configure other settings such as **Contrast, Saturation, Sharpness, TINT** and etc, use the **Up / Down** buttons to select the desired option. Follow the above procedure to set the new value.

COLOR

Press **ENTER** to access the **COLOR** menu and the first option will be highlighted.

Press **ENTER** to select the first color option.

Use the **Up / Down** buttons to navigate the available color options listed as follows.

- **7500**
- **9300**
- **6500**
- **USER COLOR**

Information

The **System Information** displays **Horizontal Frequency, Vertical Frequency, Resolution** and the Firmware Version (**Ver.**) of the monitor.

Once selected, the information below will be displayed.

- **H. FREQUENCY:** 33.7KHZ
- **V. FREQUENCY:** 60.0HZ
- **RESOLUTION:** 1920X1080I
- **VER.:** 0.11

Special Function

In the **Special Function**, you will be able to configure **OSD TIMEOUT**, **Frame Ratio**, **4:3 MARK LINE**, **Central Mark**, **Cinema Zone Mark** and **Audio Channel L & R**.

Use the **Up / Down** buttons to navigate the available options listed as follows. Press **ENTER** to access a particular option.

OSD TIMEOUT	5-120 SEC
FRAME RATIO	90 / 80 / OFF
4:3 MARK LINE	ON / OFF
CENTRAL MARK	ON / OFF
CINEMA ZONE MARK	ON / OFF
AUDIO CHANNEL L*	1/2/3/4
AUDIO CHANNEL R*	1/2/3/4

Factory Reset

The monitor menu offers a **Factory Reset** option, which will return all the monitor settings to the factory defaults

To reset the monitor, press the **MENU** button and then use the **UP / Down** buttons to navigate to the **FACTORY RESET** option. Press **ENTER** again to reset the monitor. After a few seconds, the monitor settings will return to factory defaults.

4.2 Firmware Update Procedure (Monitor)

From time to time Datavideo may release new firmware to either add new features or to fix reported bugs in the current **HS-1600T** Monitor firmware. Customers can update the firmware themselves if they wish or they can contact their local dealer or reseller for assistance should they prefer this method.

This section describes the firmware update process and it should take ***approximately 15 minutes total time to complete***. Once started ***the update process should not be interrupted in any way*** as this could result in a non-responsive unit.

To update the HS-1600T Monitor, you will need:

- The latest firmware update for the **HS-1600T Monitor**.
This firmware file can be obtained from your local Datavideo office or dealer.
- USB 2.0 pen drive with a USB A connector.

How to update the firmware

1. Unzip / extract the supplied zipped archive or rar folder.
2. Wipe the contents of the USB 2.0 pen drive so it is empty.

3. Transfer / copy the unzipped / extracted file to the USB 2.0 pen drive; make sure the file name is renamed to **MSTFLASH.bin**.
4. Plug the USB 2.0 pen drive into the USB 2.0 port labelled MONITOR F/W UPGRADE on the front of the monitor button panel.
5. Reboot **HS-1600T** and the update will start automatically.
6. The **HS-1600T Monitor** will reboot itself at the end of the process.



Note: The USB port can also be used to power the connected USB LED light.

Chapter 5 Applications

5.1 Placing a logo on the video using the lumakey function

The HS-1600T allows the user to place a logo on the video using the lumakey function. First of all, create a 1920x1080 (16:9) logo against a black or white background on a laptop. Once the logo is created, please follow the steps outlined as follows to insert the logo layer.

Note: If your logo consists primarily of dark colors, choose a white background; if the logo consists primarily of bright colors, choose a black background.

1. Connect the laptop to the switcher's **HDMI Input Port**.
2. Press the **MENU** button to open the OSD Menu on the four-quadrant Multiview display.
3. In the **Lumakey** menu, set the "**Lumakey Source**" to **Input 4**.
4. In this example, the logo is against a black background so **Black Mode** is chosen.
5. Set the "**Cleanup Level**" to 10 if the background is in total black.
6. "**Transparency**" is set to 64 if an opaque logo is desired. **Opaque** logo can be created by setting the "**Transparency**" parameter to 64. **Semi-transparency** effect can be generated by setting the "**Transparency**" parameter to a value between 0 and 64.
7. Exit the menu after the Logo is properly configured.
8. Press the **Luma Key PGM** button to place the logo on the Program screen or the **Luma Key PVW** button to place the logo on the Preview screen.

5.2 Connecting PTC-150T Cameras

DVIP is a communication interface that allows the user to control multiple PTC-150T cameras remotely. Follow the steps outlined below to set up your PTC-150T cameras with the HS-1600T.

1. Locate the DIP switch at the bottom of the PTC-150T camera



2. Set DIP Switch positions 1 and 4 to ON

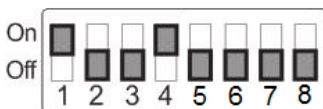

3. Power **ON** the PTC-150T PTZ Camera.
4. Open the main menu by pressing the **MENU** button on the HS-1600T's keyboard panel and select option 4 "**Remote Control**".

```
[MAIN MENU]
1:  CAMERA SET (NORMAL)
2:  MEMORY
```

```
3: VIDEO OUTPUT
4: REMOTE CONTROL
5: SYSTEM
6: CAMERA SET (ADVANCE)
7: RESET P/T/Z
8: ESCAPE
```

5. Select “**SET DVIP**” to configure the DVIP port

```
[REMOTE CONTROL]
1: PAN/TILT REVERSE: P+T
2: REMOTE SOURCE: DVIP, SW
3: SET RS422
4: SET DVIP
5: SET IR
6: PTZ INFO. OUTPUT: OFF
7: ESCAPE
```

6. Set the **DVIP baud** to 38400

```
[SET DVIP]
1: DVIP BAUDRATE: 38400
2: ESCAPE
```

7. Connect the PTC-150T to the HS-1600T, which should automatically assign an IP to the PTC-150T.

Chapter 6 Video Streaming and Recording

The HS-1600T Portable Video Studio includes a built-in Video Streaming Server (NVS-31) allowing the user to stream and record your program at the same time. From any SDI/HDMI input sources, the Datavideo's video streaming server generates an H.264 encoded stream that is compliant with RTSP or RTMP(S) protocols. While encoding the video at bit rates appropriate for live streaming, the Datavideo NVS-31 concurrently records a high-quality MP4 file to an SD card.

Note: *The built-in video streaming server and recording device are referred to as NVS-31.*

6.1 Streaming Network Connection and Device Search

This section details how to connect the NVS-31 to a network with or without a DHCP server, and describes how to acquire the NVS-31's IP address.

Connecting to a DHCP Network (DHCP Mode)

Follow the following procedure to scan your DHCP network for connected NVS-31 devices.

Note: *The NVS-31 will be automatically assigned an IP address upon connection to the DHCP network.*

1. Connect the NVS-31's stream port to the network via an Ethernet cable.
2. Turn on the HS-1600T's power and the NVS-31 will also be turned ON in the DHCP mode by default.
3. Connect the laptop to the same network that the NVS-31 is connected to and download the free IP Finder utility program.
4. Double click the IP Finder utility program icon to open the IP Finder interface.
5. Click the **SCAN** button to start searching for connected devices.

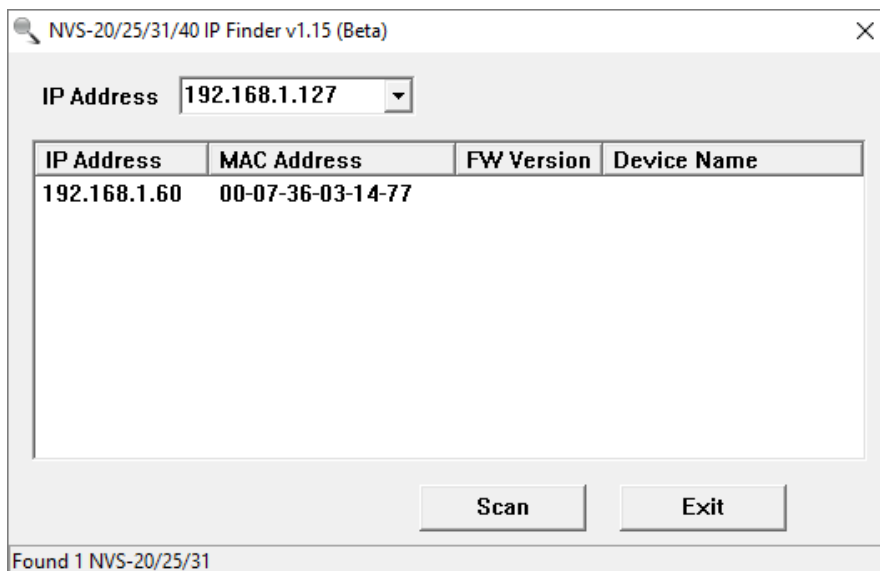
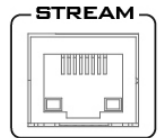

Connecting to a NON-DHCP Network (Static IP)

Upon connection to a non-DHCP network, the NVS-31 will not be assigned of any IP addresses. As such it is recommended that you manually assign a fixed IP address to the device or use the default IP address (**192.168.1.60**).

Default Fixed IP

Default Fixed IP is primarily used in point-to-point connection, such as connecting the PC to the NVS-31 directly. In a non-DHCP environment, the NVS-31 works in fixed IP mode only. To configure the NVS-31 to the **default IP**, please follow the steps outlined below:

1. Connect the NVS-31's stream port to the network via an Ethernet cable.
2. Turn on the HS-1600T's power and the NVS-31 will also be turned ON in the DHCP mode by default.
3. Search for the NVS-31 device according to the method as detailed in the previous DHCP section. Once found, log into the user interface on the web browser.
4. Enter the system page by clicking the "System" tab on the home of the user interface.
5. In the "Network Setting", disable the DHCP mode.
6. You will then be allowed to manually enter the static IP address once the DHCP mode is disabled. The static IP is 192.168.1.60 by default. The subnet mask and default gateway are 255.255.255.0 and 192.168.1.254 respectively.

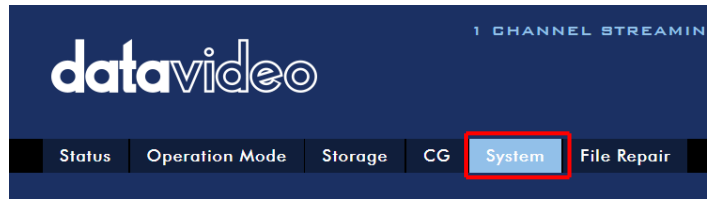
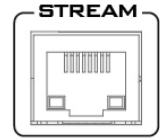

Tip: If you forget or lose the IP address, do the following to reset the network settings.

- Turn off the switcher.
- Press the **RECORD** and **STREAM** buttons at the same time then turn ON the power of the switcher
- Wait for about five seconds and release the button push as soon as you see the **RECORD** and **STREAM** button LEDs light up.
- The IP address should be the default IP which is **192.168.1.30**.

Troubleshooting the Network Connection

Connect the NVS-31 to the network and open the IP Finder utility program. Scan for the device. If not found, it is possible that your network is not assigning IP addresses. Reasons of this are outlined as follows:

- Router or DHCP server is not connected to the network.
- New devices are blocked by the network administrator.
- Anti-virus software or the firewall blocks the communication.

Solve the problem by trying the following:

- Turn off the router, wait for 10 seconds then turn on the router again.
- Reset the NVS-31 to the factory default:
 - Turn off the switcher.
 - Push the **Record and Stream** buttons simultaneously while turning on the switcher's power.
 - Wait for about five seconds and release the button push as soon as you see the **RECORD** and **STREAM** button LEDs light up.
- Reboot the PC.

If the problem still persists, try the following ways:

- Temporarily shut down the anti-virus software or firewall.
- Make sure no other devices are connected to the LAN (wired or wireless) because this may result in IP conflicts.

After trying all methods and if the problem is still not solved, the NVS-31 video streaming server offers the fixed IP feature that allows you to establish direct connection to the NVS-31. The default IP address is 192.168.1.60.

This method allows you to configure the NVS device to the IP range of your network so that you do not need a DHCP server to gain access to the NVS device.

- Connect your PC to the NVS device directly using an Ethernet cable (not necessarily a crossover cable).

Next, change the network settings of your PC or laptop.

- Click START located at the bottom left corner of your screen.
- On the text bar, enter Network Connections then click the icon that appears.
- Double click the network adapter that connects your PC or laptop to the network.
- Click the **“Properties”** button.
- Select **“Internet Protocol Version 4 (TCP/IPv4)”** option and click the **“Properties”** button.
- Check the **“Obtain an IP address automatically”** option.
- Enter IPv4 settings:
 - IP Address: 192.168.1.2
 - Subnet Mask: 255.255.255.0 (System default is 255.255.255.0)
 - Default Gateway: Not required for one-to-one connection.

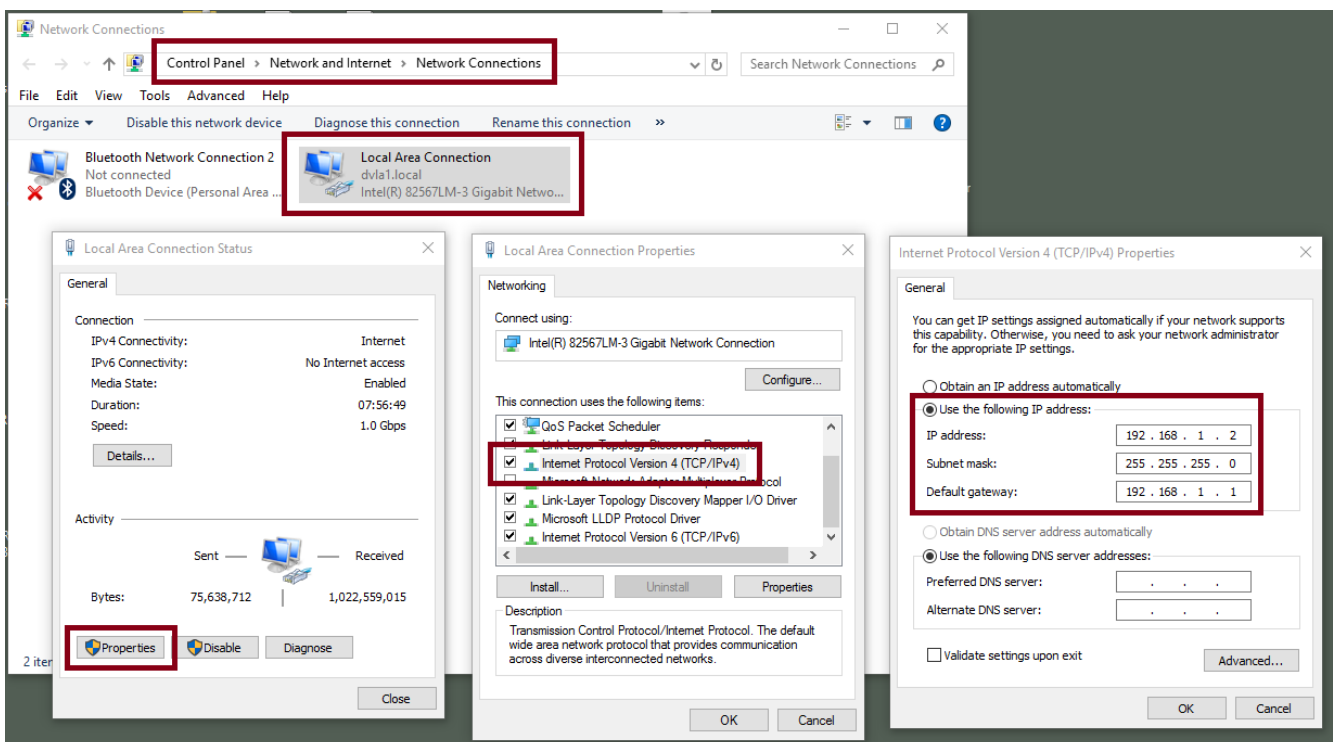

Note: Please write down the IPv4 address previously entered as it may be needed after you are done with streaming or recording.

- The NVS-31 should now be connected with an IP address of 192.168.1.60.
If the NVS-31 still cannot connect, simply restore the NVS-31 to the factory defaults.
 - Turn off the switcher.
 - Push the **Record and Stream** buttons simultaneously while turning on the switcher's power.
 - Wait for about five seconds and release the button push as soon as you see the **RECORD** and **STREAM** button LEDs light up.
 - Make sure no other devices are connected to the LAN (wired or wireless) because this may result in IP conflicts.
- Login the NVS-31 via a web browser.
 - Default user name is **admin**
 - Default password is **000000**
- Click the "**System**" tab then on the system page, enter network settings such as static IP and default gateway. Make sure that the default gateway matches your connected network and no device shares the same IP as the NVS-31.

For example, if your router's default gateway IP is 10.10.1.1, then in the default gateway field, you should also enter 10.10.1.1. Then set the IP address of the NVS-31 to 10.10.1.X, which can range from 10.10.1.2 to 10.10.1.255. Pick an unused IP address.

The screenshot shows a 'Network Setting' configuration page. It features a grid of settings:

- DHCP:** A dropdown menu currently showing 'Enable(DNS AUTO)'.
- Static IP:** A text input field containing '192.168.1.60'.
- Subnet Mask:** A text input field containing '255.255.255.0'.
- Default Gateway:** A text input field containing '192.168.1.254'.
- Primary DNS:** An empty text input field.
- Secondary DNS(Alternative):** An empty text input field.
- MAC ADDRESS:** A text input field containing '00:07:36:03:C0:20'.

- DHCP: Disable
- Static IP: X.X.X.Y; the first three decimal numbers must be the same as your router or switch. The number Y must be a number not used by any devices connected to the network.
- Subnet Mask: 255.255.255.0
- Default Gateway: Z.Z.Z.Z; same as the gateway IP of your router or switch.

Note: Some router may require special gateway IP setting; instead of the standard 192.168.1.1. Therefore, you should check the network properties on the PC before switching to the fixed IP mode.

For example, some routers have a gateway IP of 192.168.1.254 and as a result, the default gateway and primary DNS fields on the NVS-31 must also be configured to 192.168.1.254.

- Primary DNS: Same as the default gateway IP, which, if causing issues, can be changed to 8.8.8.8 or 8.8.8.4 (Public DNS provided by Google).
- Click the **“Submit”** button to save the network settings.
- Reconnect the PC and the NVS-31 to the network.
- Restore the PC’s original network settings.
- Shut down the HS-1600T; wait for approximately five seconds before turning the HS-1600T back ON.
- You should be able to access the NVS-31 through the fixed IP address.

Advanced Troubleshooting

If you still are unable to connect, please try the following:

- Use the ARP table to search for the encoder’s MAC address; the device’s MAC address is on the print label at the bottom of your HS switcher.
- MAC address starts with **00:07:36:03:xx:xx**.
 - Switcher’s MAC address starts with 00:07:36:07:xx:xx (HS-1600T and HS-1600T only)
- On the command prompt (terminal on MAC OS), enter **"arp -a"** then press enter key to display an ARP list. See if the NVS-31 is successfully connected to the network.
- Execute **services.msc**, and on the right column of the **“Services”** window, locate **“DHCP Client”** then click **“Restart”**.
- On the command prompt, enter **ipconfig/flushdns** followed by **ipconfig/release** and **ipconfig/renew**.

6.2 Web User Interface

By now, we have obtained the IP addresses of the PC and the NVS-31. Enter the NVS-31’s IP address into the address bar of a browser then hit the **ENTER** button. Login by entering the user name as well as the password into a pop-up dialogue box as shown below.



Username: admin

Password: 000000

Click **OK** to login. Once logged in, the first page that appears will be the **Status** page.

Status

You will see the **Status** page immediately after logging into the NVS-31 web UI. On the Status page, you will be able to view the **Operation Mode, Video Resolution, Stream Settings (RTSP/RTMP(S)/HLS/SRT/TS), Record Settings, Record Media** and **Messages**.



The screenshot displays the web interface for the NVS-31 device. At the top, the 'datavideo' logo is on the left, and '1 CHANNEL STREAMING ENCODER / RECORDER NVS-31' is in the center. A language dropdown menu is set to 'English'. Below the header is a navigation bar with tabs for 'Status', 'Operation Mode', 'Storage', 'CG', and 'System'. The 'Status' tab is active. The main content area shows the following configuration details:

- Operation Mode : Record and Stream
- Video Resolution : 1920x1080p, 60.00fps
- Stream Settings : Same as Input, 30fps, 2000kb/s, audio 128kb/s, RTSP
 - RTSP : rtsp://192.168.1.60:554/live2 or rtsp://192.168.1.60:8000/live2
 - RTMP :
 - TS : udp://@239.100.100.101:12345
- Record Settings : Same as Input, 30fps, 3000kb/s, audio 128kb/s
- Record Media : SD Card, EXFAT, 14.56GB [free space] / 14.00GB [total space]
- Messages :

The firmware version is noted as FW20181206NVS in the top right corner of the main content area.

Note: The NVS-31 web UI is not updated in real time so it is not synchronized with the device status.

While monitoring streaming and recording, please update the page periodically even if you choose to physically operate the device or a mixed physical and web UI operations. This ensures the page is always displaying the most up-to-date information.

Operation Mode

Click the **Operation Mode** tab on the tool bar to open the operation mode configuration page.

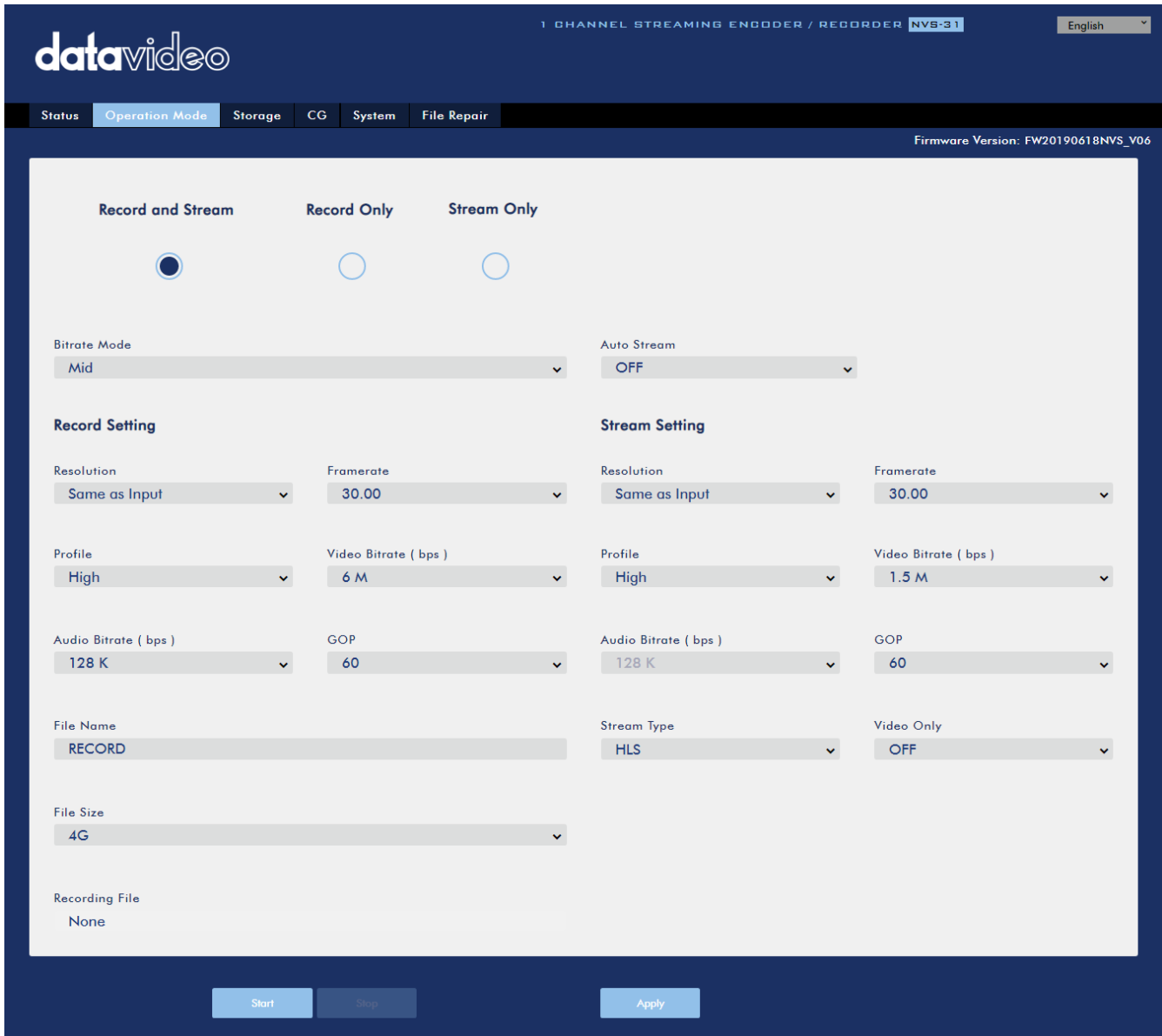

The NVS-31 offers the following operation modes:

- **Record and Stream:** Streaming and recording functions are enabled at the same time.
- **Stream Only:** Only streaming mode is enabled.
- **Record Only:** Only recording mode is enabled.

In each mode, the user will be allowed to customize various stream and record settings.

In the Stream Only mode, settings such as **Resolution**, **Frame Rate**, **Profile**, **Video Bitrate (bps)**, **Audio Bitrate (bps)**, **GOP** and **Stream Type** can be configured.

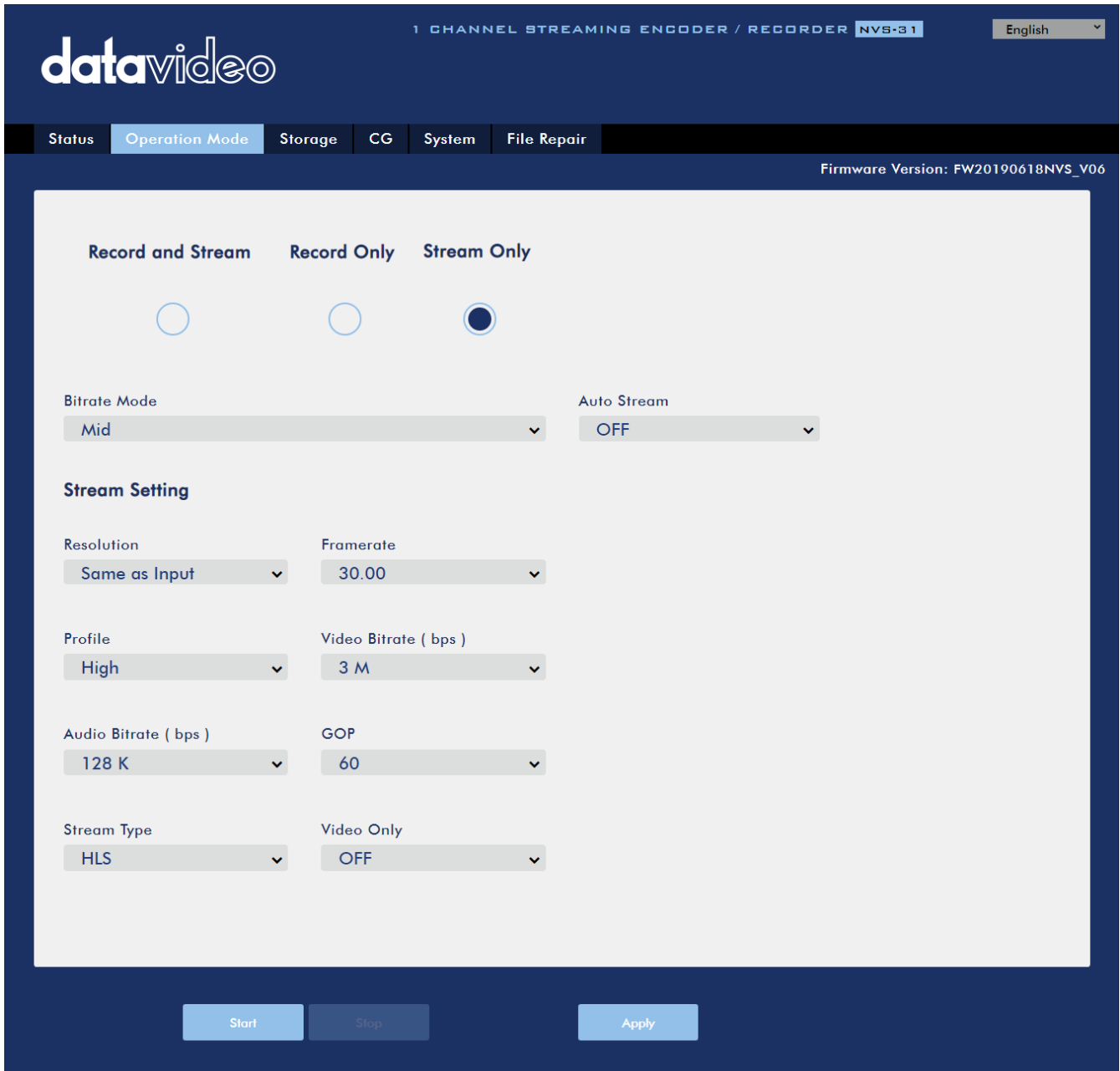

Five stream types are available on the NVS-31 and they are **RTSP**, **RTMP(S)**, **HLS**, **SRT** and **TS**. See [Section 6.3](#) for details.

Click the **“Apply”** button to apply the new stream settings. Click the **“Start”** button to open the stream and the **“Stop”** button to end the stream.



As for recording, the settings are **Resolution**, **Frame Rate**, **Profile**, **Video Bitrate (bps)**, **Audio Bitrate (bps)**, **GOP**, **File Name** and **File Size**.

Record and Stream Record Only Stream Only



Bitrate Mode

Mid

Record Setting

Resolution

Same as Input

Framerate

Same as Input

Profile

High

Video Bitrate (bps)

12 M

Audio Bitrate (bps)

128 K

GOP

60

File Name

RECORD

File Size

4G

Recording File

None





Click the **“Apply”** button to apply the new record settings. Click the **“Start”** button to start recording and the **“Stop”** button to stop recording.

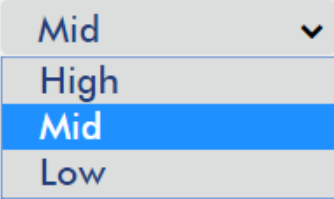

Stream and Record Settings

In the section, you will be introduced various setting options of stream and record functions.

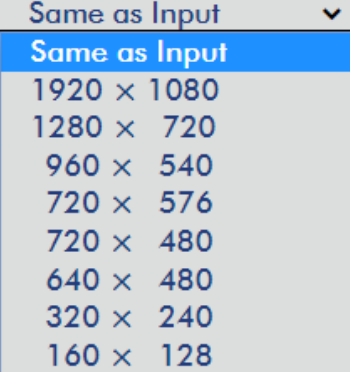
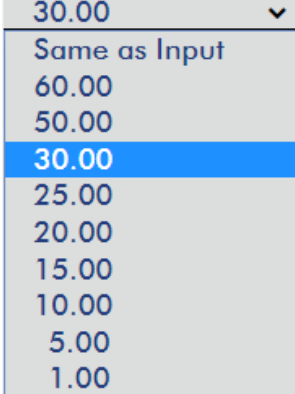
Stream Encoder Settings	
<p>Bitrate Mode</p> 	<p>Bitrate Mode</p> <p>The bitrate mode sets the video bitrate mode for your video stream. The available modes are high, mid and low.</p> <p>Note: You are allowed to switch between different bitrate modes by pressing the Bitrate button on the Record/Stream panel. See section 6.4 for details.</p>
<p>Auto Stream</p> 	<p>Auto Stream</p> <p>If the Auto Stream is enabled, in the event of power outage, the stream will be automatically restored after the switcher is powered ON again.</p>
<p>Resolution</p> 	<p>Resolution</p> <p>The first step of encoder setup is to adjust the image size. It is best to either match your original video source or scale it down. For example, capture at HD 720 and stream at HD 720. Or capture at HD 720 and stream at 540 (high).</p> <p>You should never be scaling up and streaming at a higher resolution than your original video source. For example, it does not make sense to capture at 720 and stream at 1080. Note that you will also have no gain in quality and you are using more bandwidth than is necessary for your viewers.</p> <p>You should also be aware that higher resolutions require greater processing power to encode the stream. Attempting too high of a resolution on too little processing power can result in degraded image quality and corrupted or interrupted streams or recordings.</p>
<p>Framerate</p> 	<p>Frame Rate</p> <p>Select a frame rate from the drop-down menu for video streaming. Note that frame rates should always match the frame rate of the video source.</p>

<p>Profile</p> <ul style="list-style-type: none"> Main ▾ High Main Baseline 	<p>Profile</p> <p>Profile sets the H.264 encoding profile for your stream. The available options are Baseline, Main, and High. Typically, High profile provides the best image quality and is suitable in most instances. However, depending on the decoder used when viewing the stream, such as with mobile devices, a Main or Baseline profile may be required.</p>
<p>Video Bitrate (bps)</p> <ul style="list-style-type: none"> 12 M ▾ 15 M 12 M 10 M 8 M 7 M 6 M 5 M 4 M 3 M 2.5 M 2 M 1.5 M 1 M 512 K 256 K 	<p>Video Bitrate (bps)</p> <p>The bitrate of the video specifies the amount of information stored in the video. The higher the bitrate is, the clearer the video is. However, when choosing your encoding settings for streaming, you should first check your available upload bandwidth. A good rule of thumb is for the bitrate of your stream to use no more than 50% of your available upload bandwidth capacity on a DEDICATED line. For example, if the result you get from a speed test shows that you have 2Mbps of upload speed available, your combined audio and video bitrate should not exceed 1Mbps.</p> <p>Usually high bitrate means good image quality; however, there are also exceptions. For example, SD video may appear acceptable at 1000 Kbps (1M) but HD video is unacceptable at 1000 Kbps. Therefore we recommend the following settings for your video bitrate:</p> <ul style="list-style-type: none"> • When NVS-31 is in record-only mode, the recommended video bitrate is 16 Mbps. • When NVS-31 is in stream-only mode, the recommended video bitrate is 10 Mbps. • When NVS-31 streams and records simultaneously, sum of the stream and record video bitrates should not exceed 12Mbps.
<p>Audio Bitrate (bps)</p> <ul style="list-style-type: none"> 128 K ▾ 384 K 256 K 128 K 64 K 32 K 	<p>Audio Bitrate (bps)</p> <p>The NVS-31 offers the user the following audio bitrates at which you may want to stream the audio. It is recommended to select 128Kbps or higher.</p>

<p>GOP</p> <p>60</p> <p>180</p> <p>160</p> <p>140</p> <p>120</p> <p>100</p> <p>60</p> <p>50</p> <p>30</p> <p>25</p> <p>20</p> <p>15</p> <p>10</p> <p>5</p> <p>3</p> <p>2</p> <p>1</p>	<p>GOP</p> <p>GOP pattern with longer GOP length encodes video very efficiently. Shorter GOP lengths usually work better with video that has quick movements, but they do not compress the data rate as much. Depending on your applications, the NVS-31 offers the user 16 GOP sizes ranging from 1 to 180.</p>
---	---

Stream Settings

<p>Stream Type</p> <p>RTSP</p> <p>RTSP</p> <p>RTMP</p> <p>TS</p> <p>HLS</p> <p>SRT</p>	<p>Stream Type</p> <p>The NVS-31 offers the user six stream types. There are RTSP, RTMP, TS, HLS, SRT and Youtube.</p> <p>Please note that when streaming, the NVS-31 converts video into data, which are sent across an IP network. High bitrates consume more bandwidth across the IP network. In a gigabit office LAN, high bitrate may not be a concern and Speed/Bandwidth is therefore not a limitation in an NVS-31 application environment.</p> <p>If your available bandwidth is limited, you should reduce both your resolution and your bitrate accordingly. A good rule of thumb is for the bitrate of your stream to use no more than 50% of your available upload bandwidth capacity on a dedicated line. For example, if the result you get from a speed test shows that you have 2Mbps of upload speed available, your combined audio and video bitrate should not exceed 1Mbps.</p>
--	---

Stream Type – RTSP

<p>RTSP Port</p> <p>554</p>	<p>RTSP Port</p> <p>RTSP Port is 554 by default.</p>
<p>RTSP HTTP Port</p> <p>8000</p>	<p>RTSP HTTP Port</p> <p>RTSP HTTP port is 8000 by default.</p>

<p>Video Only</p> <p>OFF <input type="checkbox"/></p> <p>OFF <input checked="" type="checkbox"/></p> <p>ON <input type="checkbox"/></p>	<p>Video Only</p> <p>Enable this option if you just want to stream the video without the audio.</p>
<p>RTSP Username/Password</p> <p>The account and password are root by default.</p> <p>RTSP Account: <input type="text" value="root"/></p> <p>RTSP Password: <input type="text" value="root"/></p>	
<p>Stream Type – RTMP(S)</p>	
<p>RTMP URL</p> <p><input type="text"/></p>	<p>RTMP URL</p> <p>Enter the RTMP URL obtained from any live streaming platform such as Ustream.</p> <p>Note: The NVS-31 supports RTMP Publish only and not RTMP Local.</p>
<p>RTMP URL</p> <p><input type="text"/></p>	<p>Stream Name</p> <p>Enter the stream name or key from any live streaming platform such as Ustream.</p>
<p>Account</p> <p><input type="text"/></p>	<p>Account</p> <p>Enter your RTMP account name.</p>
<p>Password</p> <p><input type="text"/></p>	<p>Password</p> <p>Enter the password of your RTMP account.</p>
<p>Audio Only</p> <p>OFF <input type="checkbox"/></p> <p>OFF <input checked="" type="checkbox"/></p> <p>Video Only <input type="checkbox"/></p> <p>Audio Only <input type="checkbox"/></p>	<p>Audio Only</p> <p>In this option, the user is allowed to choose to stream Audio Only or Video Only. If disabled, video and audio streams will be delivered simultaneously.</p>
<p>Stream Type – TS</p>	
<p>TS Port</p> <p><input type="text" value="12345"/></p>	<p>TS Port</p> <p>The TS port number is 12345 by default.</p>
<p>TS IP</p> <p><input type="text" value="239.100.100.100"/></p>	<p>TS IP</p> <p>The TS IP address is 239.100.100.101 by default.</p>

<div style="border: 1px solid gray; padding: 5px;"> <p>Video Only</p> <p>OFF ▼</p> <p style="background-color: #007bff; color: white; padding: 2px;">OFF</p> <p>ON</p> </div>	<p>Video Only</p> <p>Enable this option if you just want to stream the video without the audio.</p>
Stream Type – SRT	
<div style="border: 1px solid gray; padding: 5px;"> <p>SRT Port</p> <p style="background-color: #e0e0e0; padding: 2px;">9001</p> </div>	<p>SRT Port</p> <p>The SRT port is 9001 by default.</p>
<div style="border: 1px solid gray; padding: 5px;"> <p>Play URL</p> <p style="background-color: #e0e0e0; padding: 2px;">srt://192.168.1.60:9001</p> </div>	<p>Play URL</p> <p>A stream URL will be generated after the Start button is clicked.</p>
Record Encoder Settings	
<div style="border: 1px solid gray; padding: 5px;"> <p>Bitrate Mode</p> <p style="background-color: #e0e0e0; padding: 2px;">Mid ▼</p> <p style="background-color: #007bff; color: white; padding: 2px;">High</p> <p style="background-color: #007bff; color: white; padding: 2px;">Mid</p> <p style="background-color: #e0e0e0; padding: 2px;">Low</p> </div>	<p>Bitrate Mode</p> <p>The bitrate mode sets the video bitrate mode for your video stream. The available modes are high, mid and low.</p> <p>Note: You are allowed to switch between different bitrate modes by pressing the Bitrate button on the Record/Stream panel. See section 6.4 for details.</p>
<div style="border: 1px solid gray; padding: 5px;"> <p>Resolution</p> <p style="background-color: #e0e0e0; padding: 2px;">Same as Input ▼</p> <p style="background-color: #007bff; color: white; padding: 2px;">Same as Input</p> <p style="padding: 2px;">1920 × 1080</p> <p style="padding: 2px;">1280 × 720</p> <p style="padding: 2px;">960 × 540</p> <p style="padding: 2px;">720 × 576</p> <p style="padding: 2px;">720 × 480</p> <p style="padding: 2px;">640 × 480</p> <p style="padding: 2px;">320 × 240</p> <p style="padding: 2px;">160 × 128</p> </div>	<p>Resolution</p> <p>Recording resolution is the number of pixels (dots) used to create an image. Higher resolutions use more pixels to create an image. This means that greater amounts of detail can be expressed in the image, but larger files sizes and a greater amount of storage (i.e. hard drive space) are required to save the images or video.</p>
<div style="border: 1px solid gray; padding: 5px;"> <p>Framerate</p> <p style="background-color: #e0e0e0; padding: 2px;">30.00 ▼</p> <p style="background-color: #007bff; color: white; padding: 2px;">Same as Input</p> <p style="padding: 2px;">60.00</p> <p style="padding: 2px;">50.00</p> <p style="background-color: #007bff; color: white; padding: 2px;">30.00</p> <p style="padding: 2px;">25.00</p> <p style="padding: 2px;">20.00</p> <p style="padding: 2px;">15.00</p> <p style="padding: 2px;">10.00</p> <p style="padding: 2px;">5.00</p> <p style="padding: 2px;">1.00</p> </div>	<p>Frame Rate</p> <p>Frame rate greatly impacts the style and viewing experience of a video. Different frame rates yield different viewing experiences, and choosing a frame rate often means choosing between things such as how realistic you want your video to look, or whether or not you plan to use techniques such as slow motion or motion blur effects.</p> <p>Below is a list of common options for different applications:</p> <ul style="list-style-type: none"> • 24fps – This is the standard for movies and TV shows, and it was determined to be the minimum speed needed to capture video while still maintaining realistic motion. • 30fps – Videos with a lot of motion, such as sports, will often benefit from the extra frames per second.

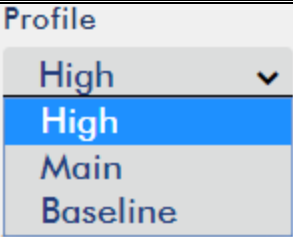
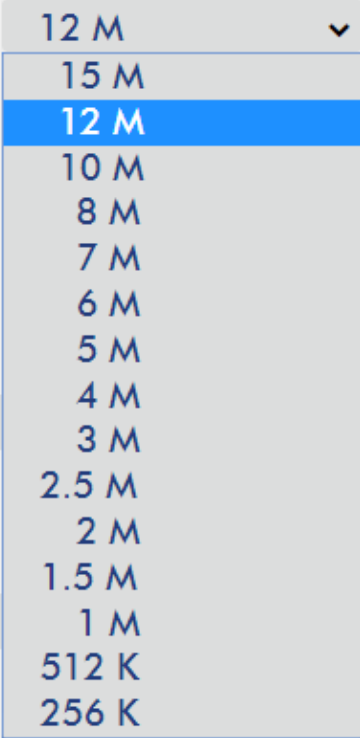
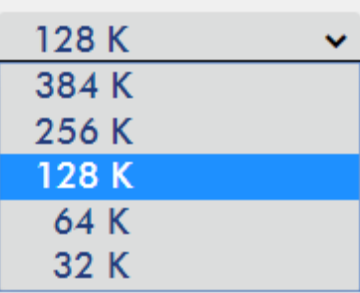
	<ul style="list-style-type: none"> • 60+fps – Anything higher than 30fps is mainly used to create slow motion video or to record video game footage.
<p>Profile</p> 	<p>Profile</p> <p>Profile sets the H.264 encoding profile for your recorder. The available options are Baseline, Main, and High. Typically, High profile provides the best image quality and is suitable in most instances.</p>
<p>Video Bitrate (bps)</p> 	<p>Video Bitrate (bps)</p> <p>The bitrate of the video specifies the amount of information stored in the video. The higher the bitrate is, the clearer the video is.</p> <p>Recommended video bitrate</p> <ul style="list-style-type: none"> • 720P or lower – 8 – 10 mbps • 1080P or higher – 15 mbps or higher
<p>Audio Bitrate (bps)</p> 	<p>Audio Bitrate (bps)</p> <p>The NVS-31 offers the user the following audio bitrates at which you may want to record the audio. It is recommended to record at 128Kbps or higher.</p>

<p>GOP</p> <p>60 ▾</p> <p>180</p> <p>160</p> <p>140</p> <p>120</p> <p>100</p> <p>60</p> <p>50</p> <p>30</p> <p>25</p> <p>20</p> <p>15</p> <p>10</p> <p>5</p> <p>3</p> <p>2</p> <p>1</p>	<p>GOP</p> <p>GOP pattern with longer GOP length encodes video very efficiently. Shorter GOP lengths usually work better with video that has quick movements, but they do not compress the data rate as much. Depending on your applications, the NVS-31 offers the user 16 GOP sizes ranging from 1 to 180.</p>
Record Settings	
<p>File Name</p> <p>RECORD</p>	<p>File Name</p> <p>Enter the name of the recording file.</p>
<p>File Size</p> <p>4G ▾</p> <p>200M</p> <p>500M</p> <p>1G</p> <p>2G</p> <p>4G</p>	<p>File Size</p> <p>Select the file size of a single recording file.</p>
<p>Recording File</p> <p>None</p>	<p>Recording File</p> <p>Display the file that is currently being recorded.</p>

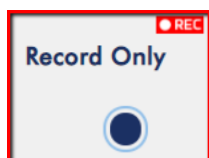

Note: The record function is activated after the Start button is clicked. The REC indicator will appear as shown on the left. Flashing indicates that the record function is starting. A solid color indicator means the record function has been activated successfully (The indicator flashing three times then turned off indicates errors). The activation time is approximately 2 to 3 seconds.

Storage

The web UI of the HS-1600T's built-in video streaming server (NVS-31) also displays storage device information, allowing the user to view the SD card status. The Status page of the web UI is shown in the diagram below.

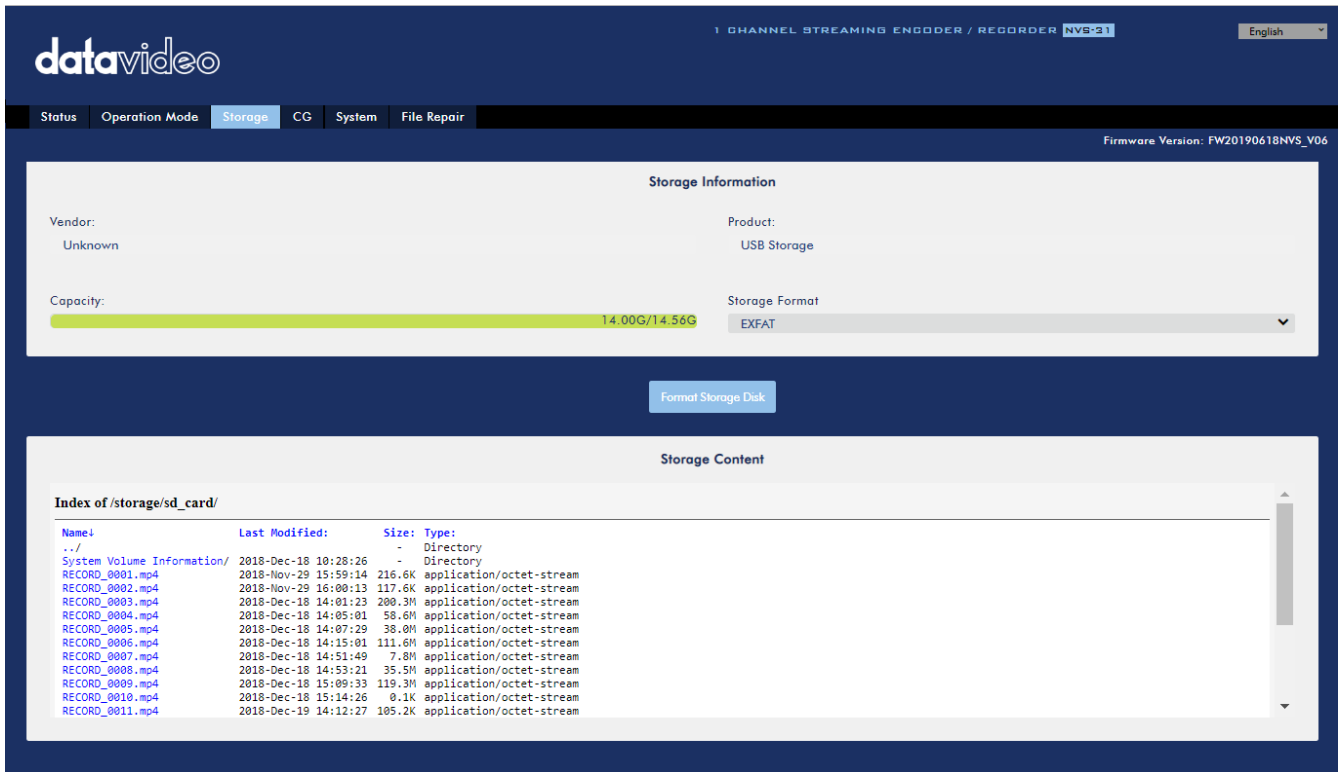

Storage Device Information																																																									
<p>Vendor: Unknown</p>	<p>Vendor Display of the manufacturer's information. Note that you should only use Class 10 SD card or above. See the Appendix, Recommended SD Cards, for a list of SD cards recommended by Datavideo.</p>																																																								
<p>Product: USB Storage</p>	<p>Product Display of the name of the SD card.</p>																																																								
<p>Capacity: 14.00G/14.56G</p>	<p>Capacity Display of the SD card's total capacity and the remaining capacity.</p>																																																								
<p>Storage Format FAT32 FAT32 EXFAT NTFS</p>	<p>Storage Format Select a storage format before clicking Format Storage Disk to format your SD card.</p> <ul style="list-style-type: none"> • FAT32 • EXFAT • NTFS 																																																								
<p>Storage Content Index of /storage/sd_card/</p> <table border="1"> <thead> <tr> <th>Name</th> <th>Last Modified</th> <th>Size</th> <th>Type</th> </tr> </thead> <tbody> <tr><td>..</td><td></td><td></td><td>Directory</td></tr> <tr><td>System Volume Information/</td><td>2018-Dec-18 10:28:26</td><td>-</td><td>Directory</td></tr> <tr><td>RECORD_0001.mp4</td><td>2018-Nov-29 15:59:14</td><td>216.6K</td><td>application/octet-stream</td></tr> <tr><td>RECORD_0002.mp4</td><td>2018-Nov-29 16:00:13</td><td>117.6K</td><td>application/octet-stream</td></tr> <tr><td>RECORD_0003.mp4</td><td>2018-Dec-18 14:01:23</td><td>200.3M</td><td>application/octet-stream</td></tr> <tr><td>RECORD_0004.mp4</td><td>2018-Dec-18 14:05:01</td><td>58.6M</td><td>application/octet-stream</td></tr> <tr><td>RECORD_0005.mp4</td><td>2018-Dec-18 14:07:29</td><td>38.0M</td><td>application/octet-stream</td></tr> <tr><td>RECORD_0006.mp4</td><td>2018-Dec-18 14:15:01</td><td>111.6M</td><td>application/octet-stream</td></tr> <tr><td>RECORD_0007.mp4</td><td>2018-Dec-18 14:51:49</td><td>7.8M</td><td>application/octet-stream</td></tr> <tr><td>RECORD_0008.mp4</td><td>2018-Dec-18 14:53:21</td><td>35.5M</td><td>application/octet-stream</td></tr> <tr><td>RECORD_0009.mp4</td><td>2018-Dec-18 15:09:33</td><td>119.3M</td><td>application/octet-stream</td></tr> <tr><td>RECORD_0010.mp4</td><td>2018-Dec-18 15:14:26</td><td>0.1K</td><td>application/octet-stream</td></tr> <tr><td>RECORD_0011.mp4</td><td>2018-Dec-19 14:12:27</td><td>105.2K</td><td>application/octet-stream</td></tr> </tbody> </table>	Name	Last Modified	Size	Type	..			Directory	System Volume Information/	2018-Dec-18 10:28:26	-	Directory	RECORD_0001.mp4	2018-Nov-29 15:59:14	216.6K	application/octet-stream	RECORD_0002.mp4	2018-Nov-29 16:00:13	117.6K	application/octet-stream	RECORD_0003.mp4	2018-Dec-18 14:01:23	200.3M	application/octet-stream	RECORD_0004.mp4	2018-Dec-18 14:05:01	58.6M	application/octet-stream	RECORD_0005.mp4	2018-Dec-18 14:07:29	38.0M	application/octet-stream	RECORD_0006.mp4	2018-Dec-18 14:15:01	111.6M	application/octet-stream	RECORD_0007.mp4	2018-Dec-18 14:51:49	7.8M	application/octet-stream	RECORD_0008.mp4	2018-Dec-18 14:53:21	35.5M	application/octet-stream	RECORD_0009.mp4	2018-Dec-18 15:09:33	119.3M	application/octet-stream	RECORD_0010.mp4	2018-Dec-18 15:14:26	0.1K	application/octet-stream	RECORD_0011.mp4	2018-Dec-19 14:12:27	105.2K	application/octet-stream	<p>Storage Content Display of the SD card content.</p> <ul style="list-style-type: none"> • File name • Last Modified • Size • Type
Name	Last Modified	Size	Type																																																						
..			Directory																																																						
System Volume Information/	2018-Dec-18 10:28:26	-	Directory																																																						
RECORD_0001.mp4	2018-Nov-29 15:59:14	216.6K	application/octet-stream																																																						
RECORD_0002.mp4	2018-Nov-29 16:00:13	117.6K	application/octet-stream																																																						
RECORD_0003.mp4	2018-Dec-18 14:01:23	200.3M	application/octet-stream																																																						
RECORD_0004.mp4	2018-Dec-18 14:05:01	58.6M	application/octet-stream																																																						
RECORD_0005.mp4	2018-Dec-18 14:07:29	38.0M	application/octet-stream																																																						
RECORD_0006.mp4	2018-Dec-18 14:15:01	111.6M	application/octet-stream																																																						
RECORD_0007.mp4	2018-Dec-18 14:51:49	7.8M	application/octet-stream																																																						
RECORD_0008.mp4	2018-Dec-18 14:53:21	35.5M	application/octet-stream																																																						
RECORD_0009.mp4	2018-Dec-18 15:09:33	119.3M	application/octet-stream																																																						
RECORD_0010.mp4	2018-Dec-18 15:14:26	0.1K	application/octet-stream																																																						
RECORD_0011.mp4	2018-Dec-19 14:12:27	105.2K	application/octet-stream																																																						

CG

The CG function on the HS-1600T's built-in video streaming server allows the user to place a textual layer on top of the video. The CG settings on the CG page are shown in the diagram below.

CG Settings	
<p>ON/OFF</p> <p>OFF</p> <p>OFF</p> <p>ON</p>	<p>CG Enable/Disable</p> <p>Select ON/OFF from this drop-down menu to enable/disable the CG overlay function.</p>
<p>Text</p> <p>%H:%M:%S</p>	<p>Text</p> <p>Enter the text of the CG overlay.</p>
<p>Location-X</p> <p>200</p>	<p>Location-X</p> <p>Enter the x-coordinate.</p>
<p>Location-Y</p> <p>200</p>	<p>Location-Y</p> <p>Enter the y-coordinate.</p>
<p>Background</p> <p>None</p> <p>None</p> <p>Black</p>	<p>Background</p> <p>You can either select a black background or none.</p>

<p>Text Size</p> <p>10 ✓</p> <p>8</p> <p>9</p> <p>10</p> <p>11</p> <p>12</p> <p>13</p> <p>14</p> <p>15</p> <p>16</p> <p>17</p> <p>18</p> <p>19</p> <p>20</p>	<p>Text Size</p> <p>Select the font size of your CG overlay text.</p>
--	--

System

The system page of the HS-1600T's built-in video streaming server allows the user to configure several network and system related settings such as **DHCP enable/disable, static IP address, subnet mask, default gateway, primary and secondary DNS**, and etc.

The system settings are **HLS preview enable/disable, time settings, firmware update, device name, and account login information**.

The system page is shown in the diagram below.

Network Setting

DHCP

Enable(DNS AUTO) ▼

Static IP

192.168.1.60

Subnet Mask

255.255.255.0

Default Gateway

192.168.1.254

Primary DNS

Secondary DNS(Alternative)

MAC ADDRESS

00:07:36:03:AA:01

Submit

HLS Preview Setting

HLS Preview

OFF ▼

Submit

Time Setting

Type

Manually ▼

Timezone

UTC+8 ▼

Submit

Date

2019-06-20

Time

14:15:05

Firmware Update

File Path

Browse

Update

Device Name Setting

Device Name

Submit

Account Setup

Original Account

Original Password

Apply

System Control

Restore to Default

System Reboot

Network Settings	
<p>DHCP</p> <div style="border: 1px solid #ccc; padding: 5px;"> <p>Enable(DNS AUTO) ▼</p> <p style="background-color: #007bff; color: white;">Enable(DNS AUTO)</p> <p>Enable</p> <p>Disable</p> </div>	<p>DHCP IP Assignment</p> <p>Select an option from this drop-down menu:</p> <ul style="list-style-type: none"> Enable (DNS AUTO) Enable Disable
<p>Static IP</p> <div style="border: 1px solid #ccc; padding: 5px; background-color: #f0f0f0;"> <p>192.168.1.60</p> </div>	<p>Static IP Address</p> <p>The static IP field will be activated for the user to manually enter an IP address once the DHCP is disabled. The static IP is 192.168.1.60 by default.</p> <p>Tip: If you do not know the device’s IP address, you can always use the following method to reset the network settings.</p> <ul style="list-style-type: none"> Shut down the machine Turn on the machine while holding down RECORD and STREAM buttons simultaneously. Approximately after 5 seconds, release the RECORD and STREAM buttons as soon as the button LEDs are turned ON. Fixed IP address is 192.168.1.60 by default.
<p>Subnet Mask</p> <div style="border: 1px solid #ccc; padding: 5px; background-color: #f0f0f0;"> <p>255.255.255.0</p> </div>	<p>Subnet Mask</p> <p>Static IP address mode requires subnet mask, which is 255.255.255.0 by default.</p>
<p>Default Gateway</p> <div style="border: 1px solid #ccc; padding: 5px; background-color: #f0f0f0;"> <p>192.168.1.254</p> </div>	<p>Default Gateway</p> <p>Static IP address mode requires default gateway, which is 192.168.1.254 by default.</p>
<p>Primary DNS</p> <div style="border: 1px solid #ccc; padding: 5px; background-color: #f0f0f0;"> <p> </p> </div>	<p>Primary DNS (Optional)</p> <p>Primary DNS is required in static IP mode only but optional.</p>
<p>Secondary DNS(Alternative)</p> <div style="border: 1px solid #ccc; padding: 5px; background-color: #f0f0f0;"> <p> </p> </div>	<p>Secondary DNS (Optional)</p> <p>Secondary DNS is required in static IP mode only but optional.</p>
<p>MAC ADDRESS</p> <div style="border: 1px solid #ccc; padding: 5px; background-color: #f0f0f0;"> <p>00:07:36:03:C0:20</p> </div>	<p>MAC Address</p> <p>Display of NVS-31’s MAC address.</p>
<div style="border: 1px solid #ccc; padding: 10px; background-color: #007bff; color: white; width: fit-content; margin: 0 auto;"> <p>Submit</p> </div>	<p>Submit Button</p> <p>After the network settings are configured, click the Submit button to save the new settings.</p>

<p>HLS Preview</p> <p>OFF <input type="button" value="v"/></p> <p>OFF</p> <p>ON</p> <p><input type="button" value="Submit"/></p>	<p>HLS Preview</p> <p>Here you will be able to enable/disable HLS preview. Click the Submit button to save the new settings.</p>
<p>Time Setting</p>	
<p>Type</p> <p>Manually <input type="button" value="v"/></p> <p>Automatically from the internet</p> <p>Manually</p>	<p>Type</p> <p>In this drop-down menu, you can either select to allow the device to retrieve the time automatically from the Network Time Protocol (NTP) server or manually select a time zone from the Time Zone drop-down menu.</p>
<p>Timezone</p> <p>UTC+8 <input type="button" value="v"/></p> <p>UTC-12</p> <p>UTC-11</p> <p>UTC-10</p> <p>UTC-9</p> <p>UTC-8</p> <p>UTC-7</p> <p>UTC-6</p> <p>UTC-5</p> <p>UTC-4</p> <p>UTC-3</p> <p>UTC-2</p> <p>UTC-1</p> <p>UTC+0</p> <p>UTC+1</p> <p>UTC+2</p> <p>UTC+3</p> <p>UTC+4</p> <p>UTC+5</p> <p>UTC+6</p> <p>UTC+7</p> <p>UTC+8</p> <p>UTC+9</p> <p>UTC+10</p> <p>UTC+11</p> <p>UTC+12</p>	<p>Time Zone</p> <p>Click the drop-down menu to select a time zone for your device.</p>
<p>Date</p> <p>2018-12-19</p> <p>Time</p> <p>15:16:38</p>	<p>Date/Time</p> <p>Date and Time fields show the device's system date and time values.</p>

<div style="text-align: center;"> June 2019 </div>						
Su	Mo	Tu	We	Th	Fr	Sa
						1
2	3	4	5	6	7	8
9	10	11	12	13	14	15
16	17	18	19	20	21	22
23	24	25	26	27	28	29
30						

You will see the calendar on the left after clicking the Date field. Simply click a day to set the date.

Click the **Submit** button to save the new settings.

Firmware Update

File Path

NVS-31 Firmware Update
 Click the **Browse** button to search for the latest firmware file saved on the PC's hard disk. Click the **Update** button after the latest firmware file is uploaded.

Device Name Setting

Device Name Setting

Device Name

Device Name Setting
 Enter a name for this device and click the **Submit** button to write this name into the device.

Account Setup

Account Setup

Original Account Original Password

Account Setup
 Enter the NVS-31's account name and password. Click the **Apply** button to save the new settings.

System Control

Restore to Default
 Click this button to restore default settings.

System Reboot
 Click this button to reboot the NVS-31.

File Repair

The system may crash while the recording is in progress. If this happens, your record file may be damaged. To repair a damaged file, go the **File Repair** page to run the file repair process.

1. Open the “**File Repair**” page and click the “**File List**” drop-down menu to select the damaged MP4 file.

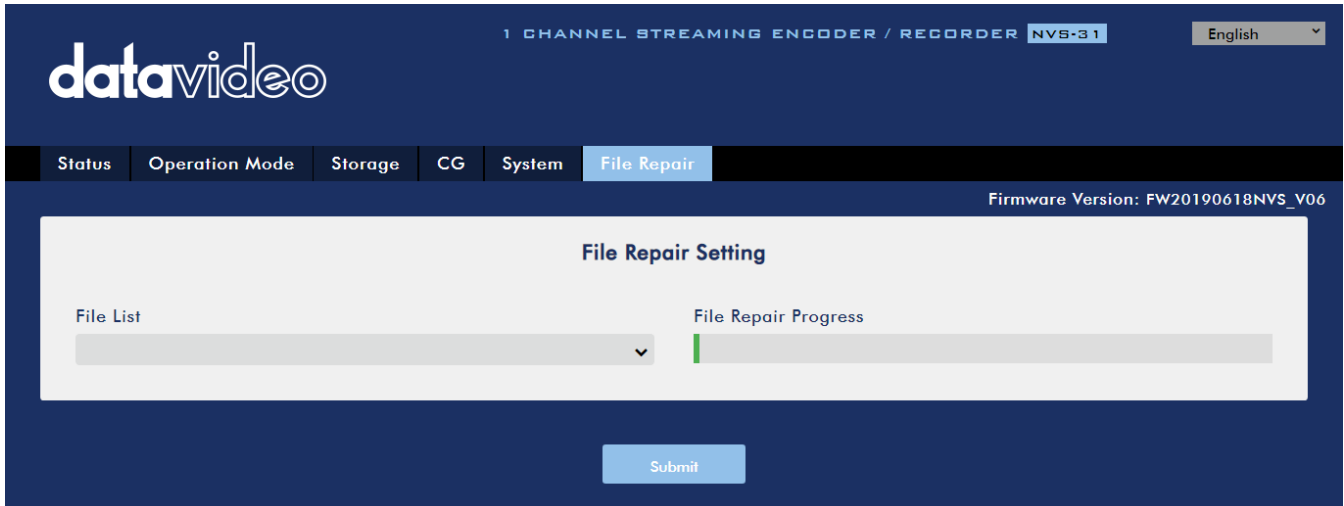

2. If the MP4 file can be repaired, you will see a pop-up dialogue box prompting “**MP4_FIX_OK**”, click **OK** then the “**Submit**” button.

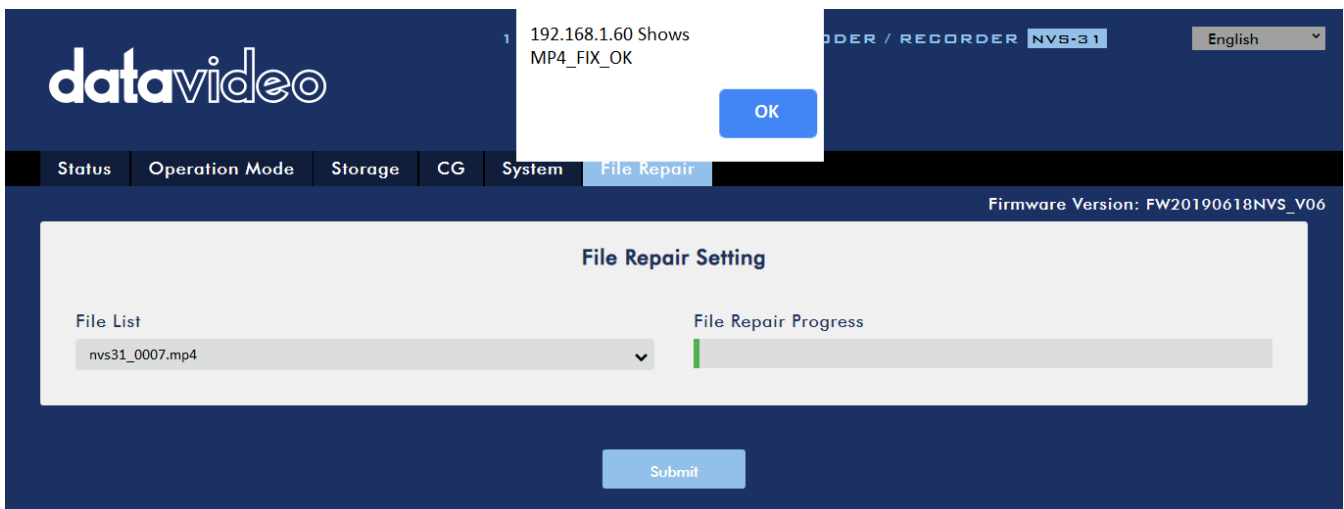

Note: If the selected MP4 file cannot be repaired, a dialogue box prompting “**MP4_FIX_ERROR_MDATA**” will pop up.

3. The file is repaired when you see a dialogue box prompting “**File repair finish!!**”. Click OK and reboot the NVS-31.

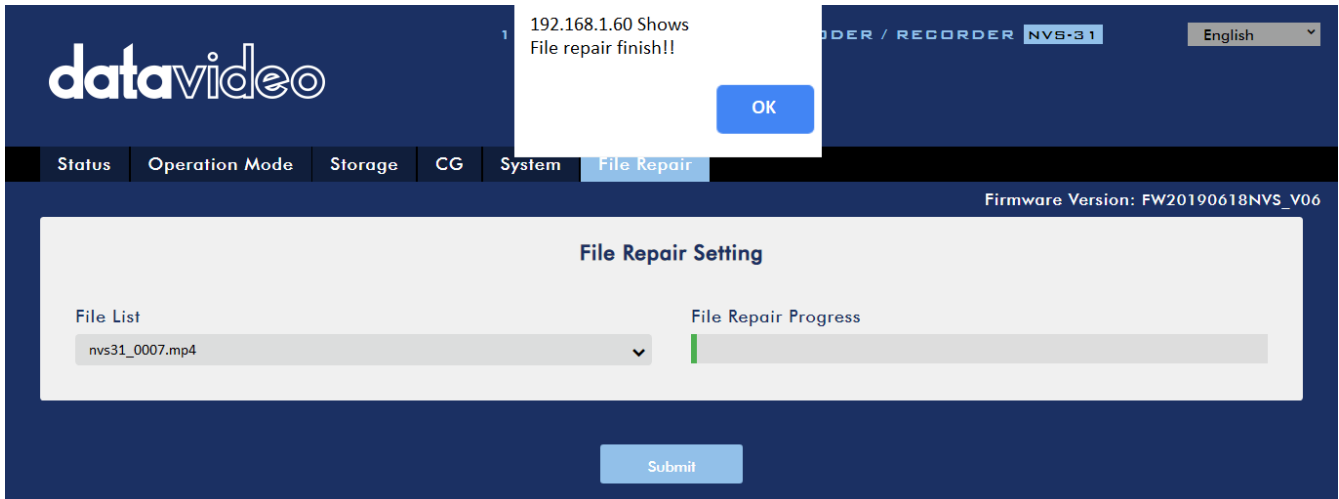

4. After the NVS-31 successfully reboots, you will see the repaired file with the file name of the damaged file appended of the word "new".

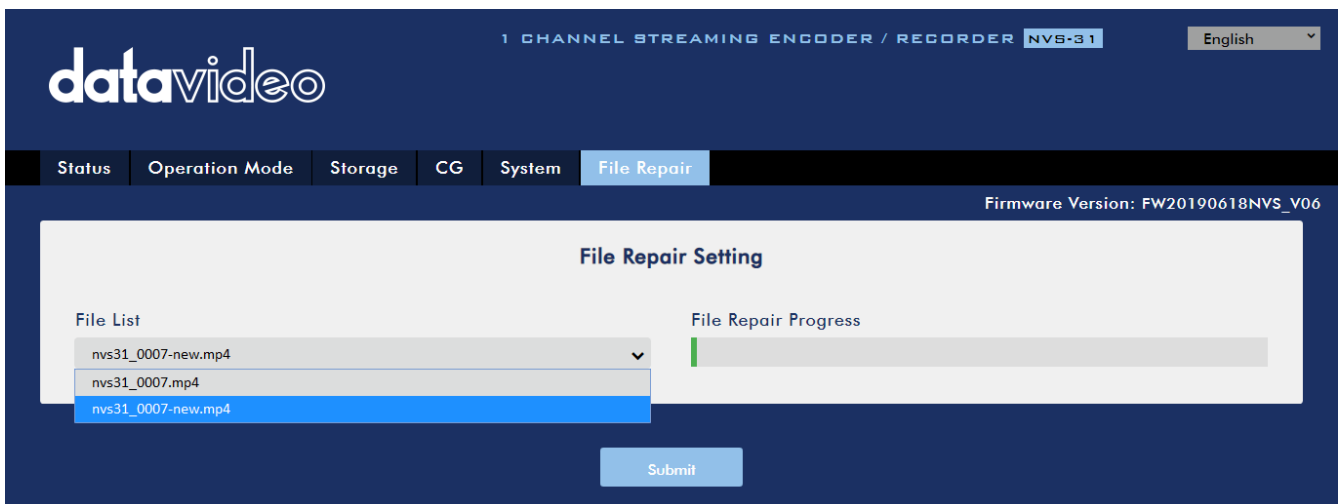

6.3 Operations

In this section, we will discuss how you can play the video using different streaming protocols and how to place texts on your video.

Video Streaming

The NVS-31 provides the user with different video streaming options such as RTSP, TS, RTMP(S), HLS, and SRT.

This section discusses settings of these options and how to stream your video using these methods.

RTSP/TS/HLS/SRT

In the **RTSP/TS/HLS/SRT** modes, the **NVS-31** is a stream server which allows any client device to connect and playback your video stream. However, if you would like to stream to multiple client devices, we recommend using a separate media server to set up your streaming environment.



The following operation procedure uses VLC media player to playback video stream. If your PC or laptop does not have VLC media player installed, please visit VideoLAN's official homepage (<https://www.videolan.org/>) and download the installation file then install the program.

Follow the steps below to obtain the RTSP URL:

1. Open the stream settings page
2. Select RTSP

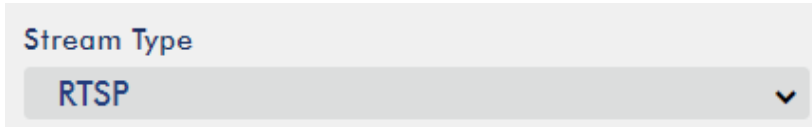

3. Click the **Start** button to generate the RTSP URL.



4. Based on your settings, the device will automatically generate the RTSP URL.

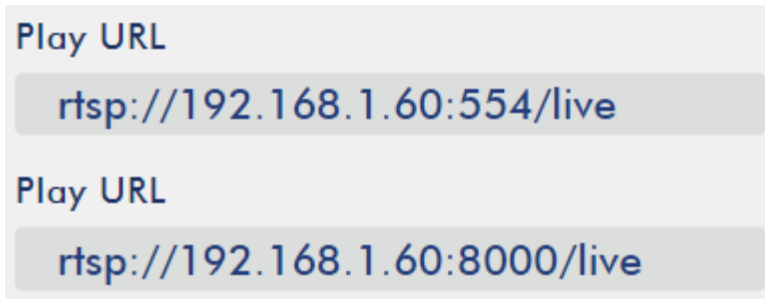

5. Before streaming the video via RTSP, enter the RTSP URL into the client device.
6. Open VLC then click **Open Network Stream** (shown in the diagram below).

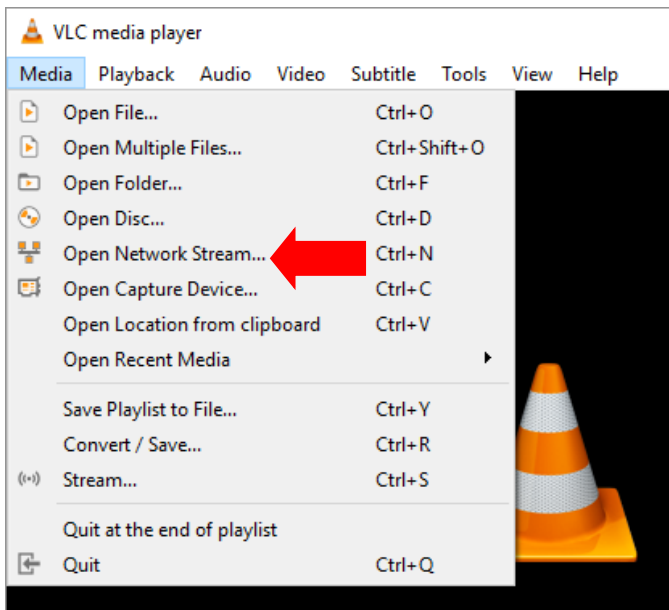

7. As shown in the diagram below, enter the stream URL then click **Play** to start streaming.

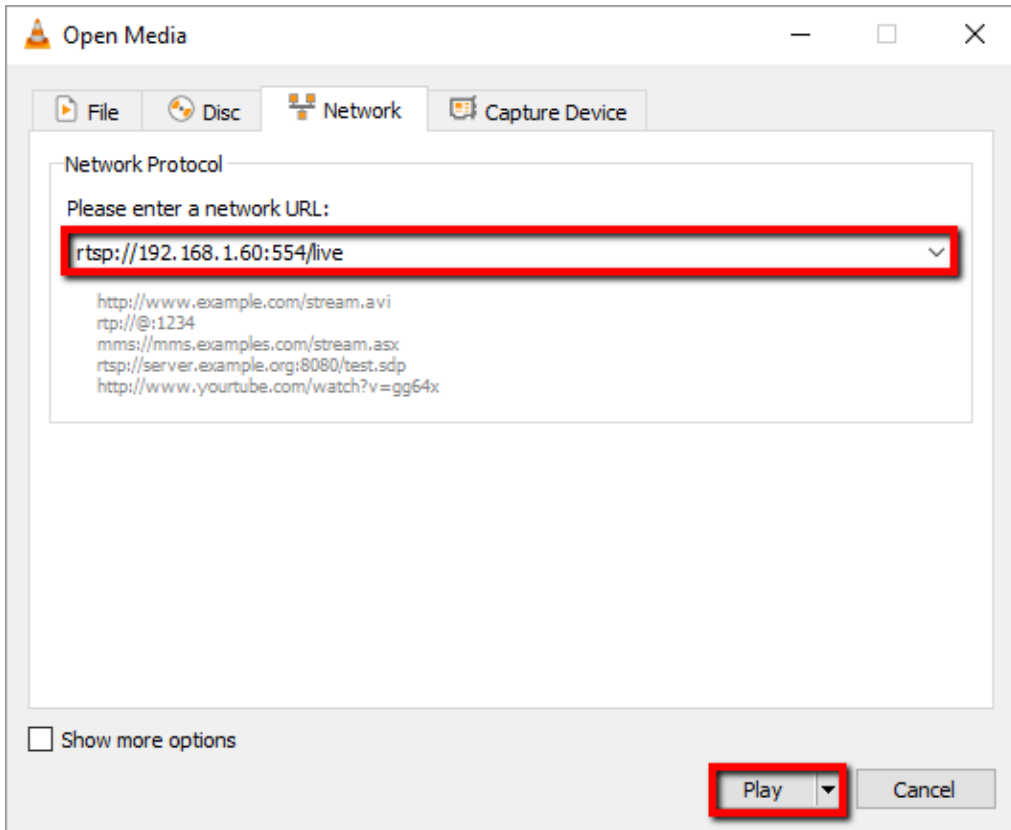

Follow the steps below to obtain the TS URL:

1. Open the stream settings page
2. Select TS.



3. Enter the TS port number which is 12345 by default.

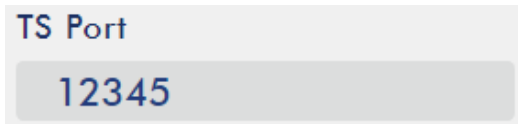

4. In the TS IP field, enter your PC's IP address such as 192.168.1.66.

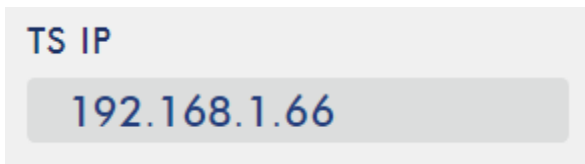

5. Click the **Start** button to generate the TS URL which, in this example, will be udp://@192.168.1.66:12345 as shown in the diagram below.



6. Before streaming the video via TS, enter the TS URL into the client device.

7. Open VLC then click **Open Network Stream** (shown in the diagram below).

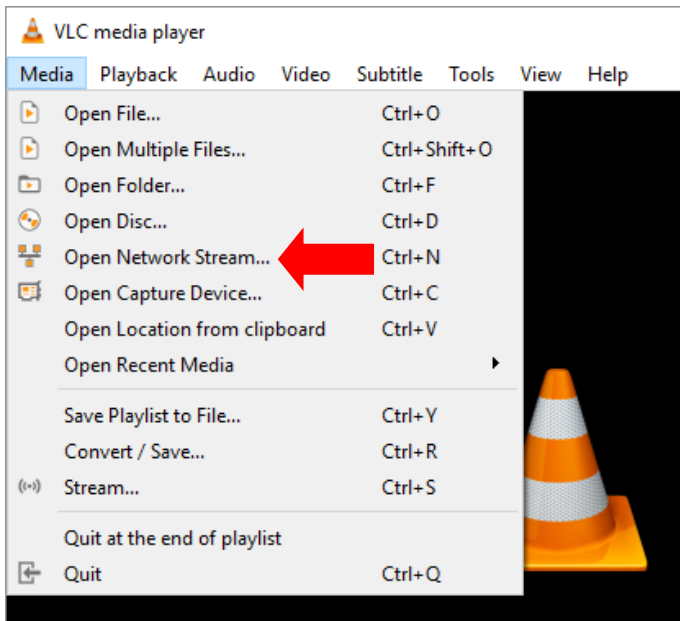

8. As shown in the diagram below, enter the stream URL then click **Play** to start streaming.

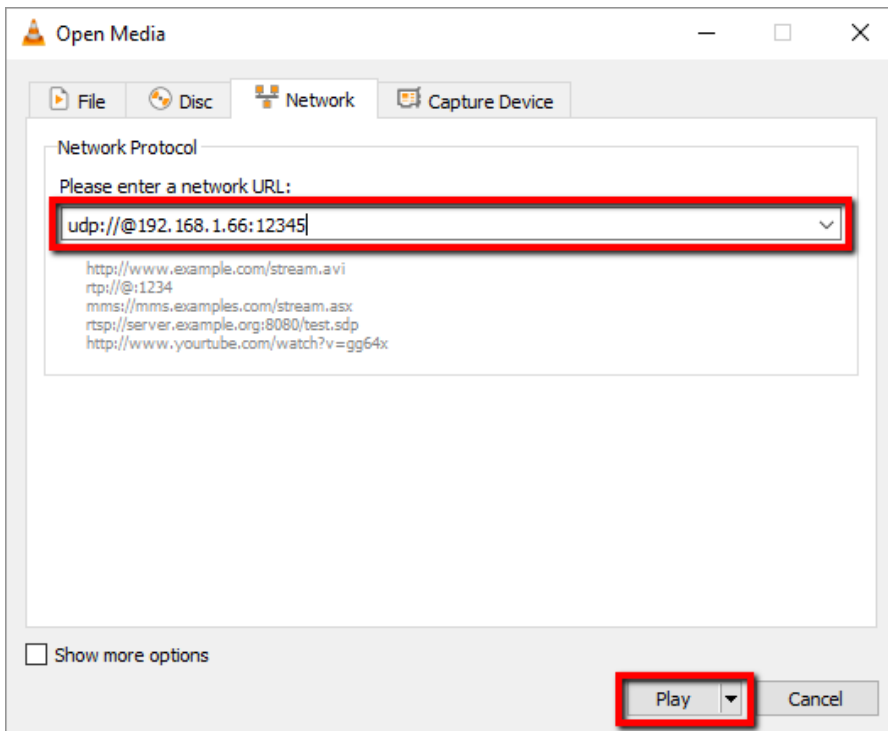

Follow the steps below to obtain the HLS URL:

1. Open the stream settings page
2. Select **HLS**



3. Click the **Start** button to generate the HLS URL.

Start

4. Based on your settings, the device will automatically generate a .m3u8 stream URL as shown below.

Play URL

<http://192.168.1.60/hls/index.html>

Play URL

<http://192.168.1.60/hls/live.m3u8>

5. Before streaming the video via **HLS**, enter the **HLS** URL into the client device.
6. Open VLC then click **Open Network Stream** (shown in the diagram below).

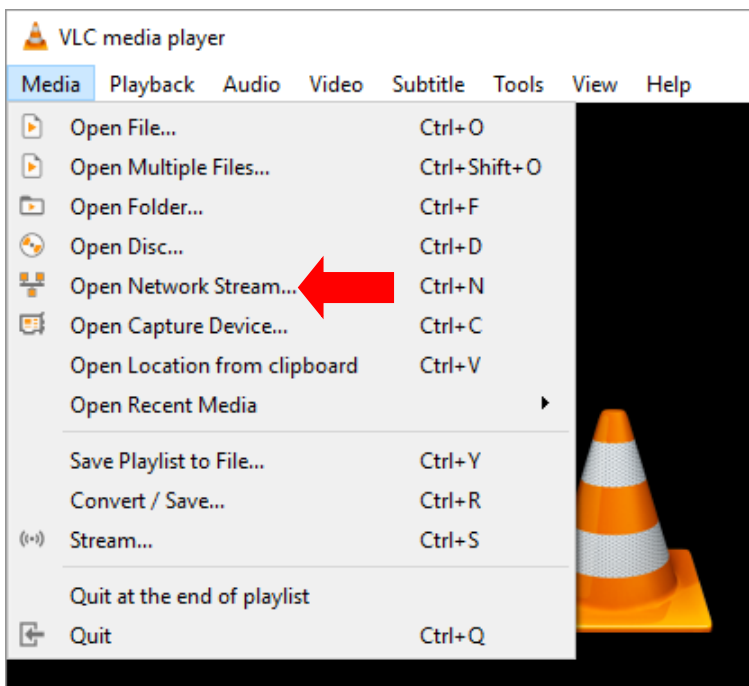

7. As shown in the diagram below, enter the stream URL then click **Play** to start streaming.

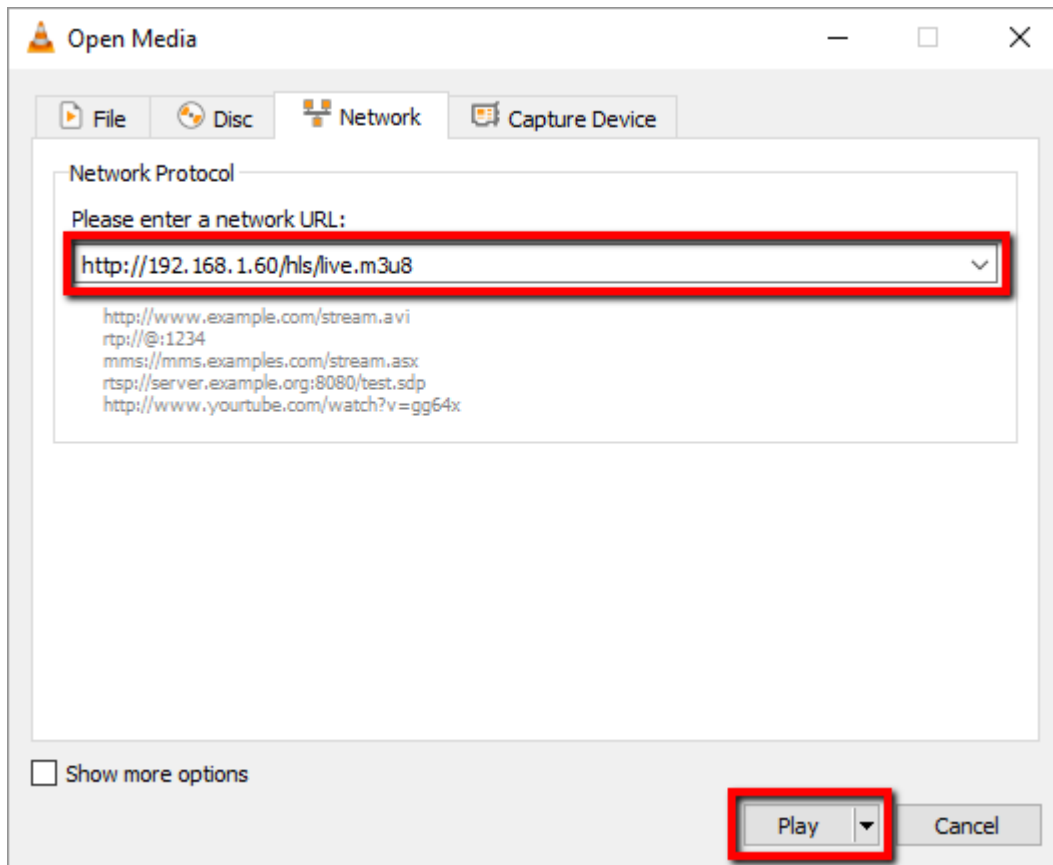

8. You can also play .m3u8 stream URL using the devices listed as follows:
- iPhone, iPad and MacBook: Use Safari to open the .m3u8 stream URL.
 - Windows 10: Use Microsoft Edge to open the .m3u8 stream URL.

Follow the steps below to obtain the SRT URL:

1. Open the stream settings page
2. Select **SRT** and the **SRT port number** is 9001 by default.

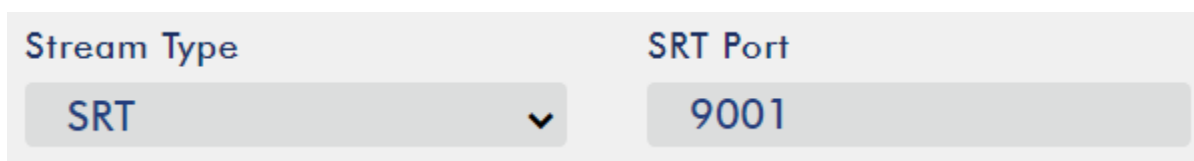

3. Click the **Start** button to generate the SRT URL.



4. Before streaming the video via **SRT**, enter the **SRT URL** into the client device.



5. Open VLC then click **Open Network Stream** (shown in the diagram below).

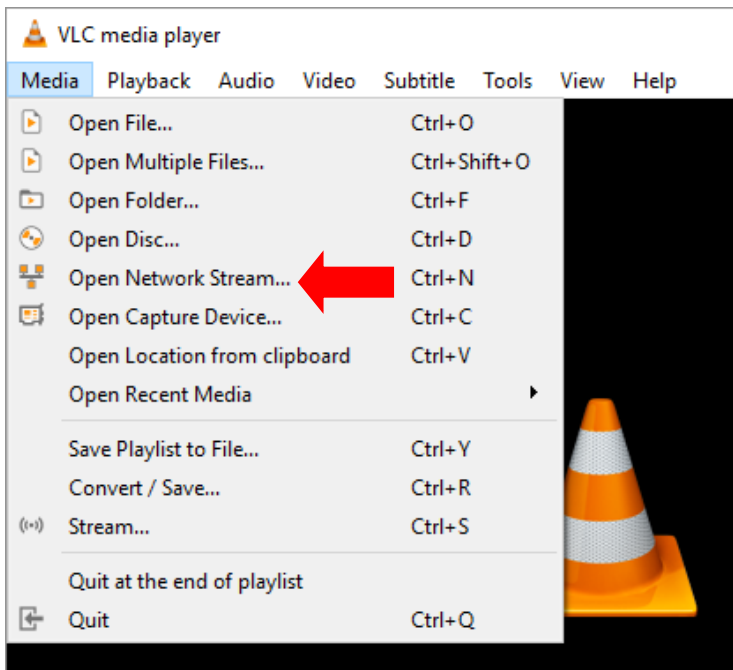

6. As shown in the diagram below, enter the stream URL then click **Play** to start streaming.

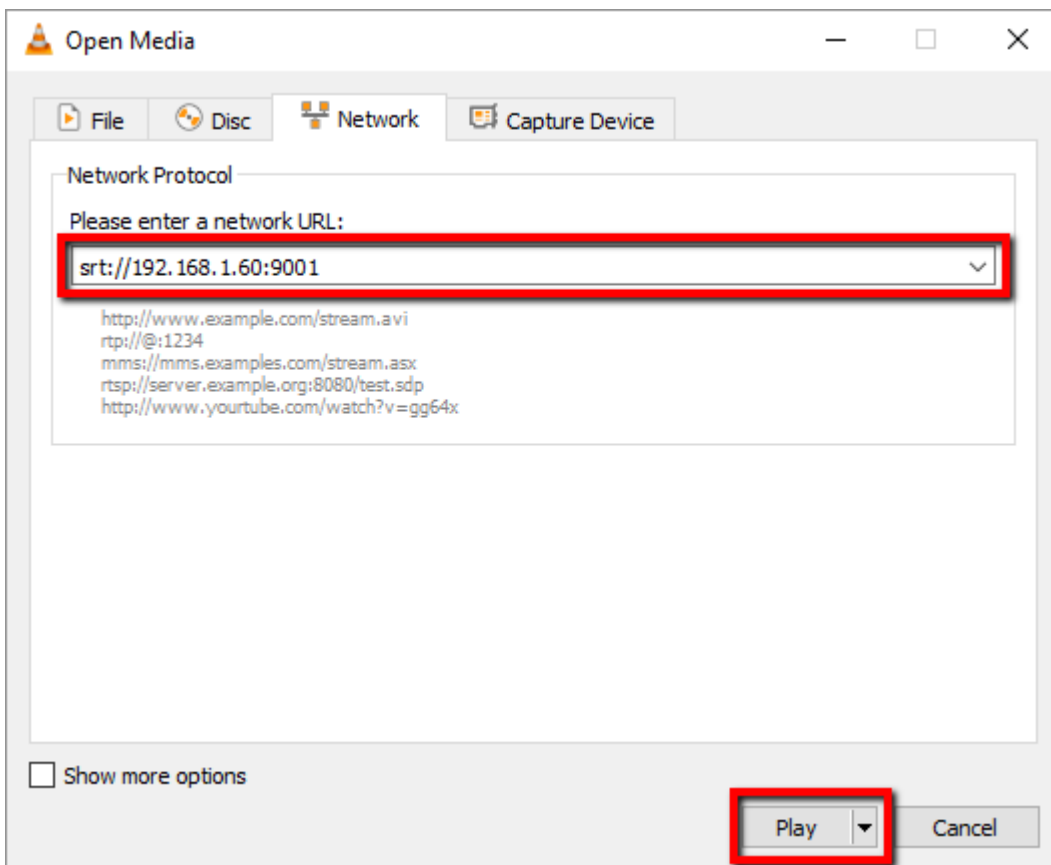

RTMP(S)

In the **RTMP(S)** mode, the NVS-31 can only send one data stream to one CDN or media server that supports the **Real-Time Messaging Protocol** or the **Real-Time Messaging Protocol over an TLS/SSL connection**. Examples of the **RTMP(S)** media server are **USTREAM** and **Youtube**.

Note: The NVS-31 supports RTMP only and not the RTMP local.

In the following section, we will show you how to set up an **RTMP(S)** stream to **Youtube**. The step-by-step account setup is outlined as follows:

1. First of all, you have to obtain Server URL and Stream name/key from Youtube.
2. Open the Youtube Live Dashboard https://www.youtube.com/live_dashboard
3. On the left column, locate and click “**Stream now.**”

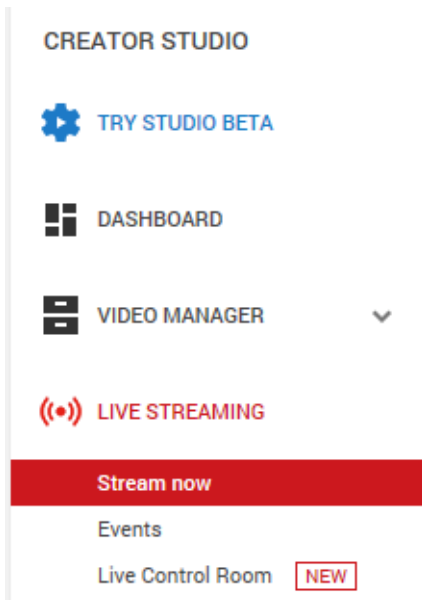

4. On the right, scroll down to the bottom where you will be able to find **Server URL** and **Stream name/key**.

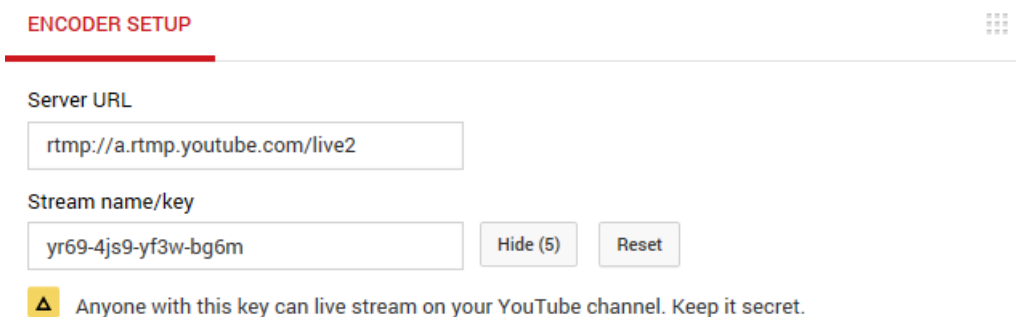

5. On the NVS-31, open the **Stream Only** operation mode page.
6. Select **RTMP** from the Stream Type drop-down menu.



7. Enter the **Server URL (rtmp://a.rtmp.youtube.com/live2)** obtained from the **Youtube Live Streaming** page into the **RTMP URL** field.

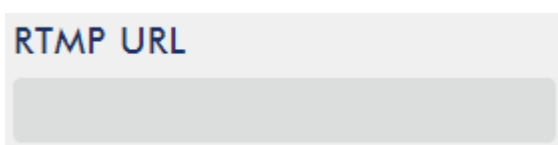

8. Enter the **Stream name/key (yr69-4js9-yf3w-bg6m)** obtained from the **Youtube Live Streaming** page into the **StreamName** field.

StreamName

9. As required by the live streaming channel, enter your Youtube account name and password into the **Account** and **Password** fields.

Account Password

10. Click the **Start** button to start streaming the live video on the **Youtube Live Streaming** page. You should also see an **RTMP URL** generated.
11. The **RTMP URL** is another alternative that allows you to view the live stream on a web browser. Enter the **RTMP URL** into the web browser's address bar then hit the **Enter** button to open the live video stream.
12. Click the **Stop Stream** button to stop live streaming.

Stop

Tip: You are allowed to stream audio or video only.

Text Overlay Video

The HS-1600T's built-in video streaming server not only allows you to stream and record your program, it also features a CG tool that is capable of overlaying text on the video currently being broadcast.

The CG settings page is shown below:

1 CHANNEL STREAMING ENCODER / RECORDER NVS-31 English

Status Operation Mode Storage **CG** System

Firmware Version: FW20181206NVS

OSD

ON/OFF OFF Text %H:%M:%S

Location-X 200 Location-Y 200

Background None Text Size 10

Apply

Follow the steps below to overlay text on the video:

1. Open the **CG** settings page.
2. Enable the CG function.
3. In the **Text** field, enter the overlay text.
4. Enter the **X and Y coordinates** to set the text position.
5. Click the **Apply** button to save the new settings.

Note: Increasing the X coordinate moves the overlay text to the right and decreasing the X coordinate moves the overlay text to the left; increasing the Y coordinate moves the overlay text up and decreasing the Y coordinate moves the overlay text down.

6.4 Stream and Record Buttons

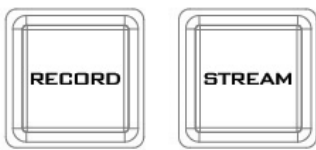

The **RECORD** and **STREAM** buttons on the front panel of the HS-1300 give the user certain controls of the record and stream functions. In this section, we will cover operations of these two buttons in detail.

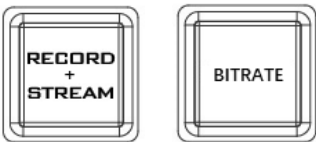

Button LED behaviors and their corresponding states are listed in the table below:

	RECORD Button	STREAM Button	RECORD+STREAM Button
Solid White	Record function in idle state	Stream function in idle state	Record/Stream functions in idle state simultaneously
Blinking Red	Record function is activating or resetting	Stream function is activating or resetting	Record/Stream functions are activating or resetting simultaneously
Solid Red	Record function activated	Stream function activated	Record/Stream functions are activated simultaneously

Record Button

Start recording

- When idle, the **RECORD** button is solid white.
- Press and hold the **RECORD** button for approximately 2 seconds.
- When the record function is activating, the **RECORD** button turns from solid white, then blinking red and finally to solid red.
- When the **RECORD** button is solid red, this indicates that the record function has been successfully activated.

Note: The **RECORD** button is disabled in the **Stream Only** mode.

Stop recording

- While recording, the **RECORD** button is solid red.
- Press and hold the **RECORD** button for approximately 2 seconds.
- When the record function is terminating, the **RECORD** button turns from solid red, then blinking red and finally to solid white.
- When the **RECORD** button is solid white, this indicates that the record function has been successfully terminated.

Stream Button

Start streaming

- When idle, the **STREAM** button is solid white.
- Press and hold the **STREAM** button for approximately 2 seconds.
- When the stream function is activating, the **STREAM** button turns from solid white, then blinking red and finally to solid red.
- When the **STREAM** button is solid red, this indicates that the record function has been successfully activated.

Note: The STREAM button is disabled in the Record Only mode.

Stop streaming

- While streaming, the **STREAM** button is solid red.
- Press and hold the **STREAM** button for approximately 2 seconds.
- When the stream function is terminating, the **STREAM** button turns from solid red, then blinking red and finally to solid white.
- When the **STREAM** button is solid white, this indicates that the stream function has been successfully terminated.

Record+Stream Button

Start recording/streaming simultaneously

- When idle, the **RECORD+STREAM** button is solid white.
- Press and hold the **RECORD+STREAM** button for approximately 2 seconds.
- When the record and stream functions are activating simultaneously, the **RECORD+STREAM** button turns from solid white, then blinking red and finally to solid red.
- When the **RECORD+STREAM** button is solid red, this indicates that the record and stream functions have been successfully activated.

Stop recording/streaming simultaneously

- While recording and streaming simultaneously, the **RECORD+STREAM** button is solid red.
- Press and hold the **RECORD+STREAM** button for approximately 2 seconds.
- When the record and stream functions are terminating, the **RECORD+STREAM** button turns from solid red, then blinking red and finally to solid white.
- When the **RECORD+STREAM** button is solid white, this indicates that the record and stream functions have been successfully terminated.

Bitrate Button

Follow the steps below to switch the stream bitrate mode using the **BITRATE** button:

- Press and hold one of the **RECORD+STREAM** button, the **RECORD** button, and the **STREAM** button until the pressed button starts blinking red.
- Continue holding down one of the **RECORD+STREAM** button, the **RECORD** button, and the **STREAM** button while pressing the **BITRATE** button to switch stream bitrate mode (H, M or L).

Note: The system will return to original settings if the **BITRATE** button push is not sensed. The default bitrate is M.

Operation Mode

Checking the NVS-31's operation mode

Follow the steps below to check the NVS-31's current operation mode:

- First make sure the stream and record functions are in idle state, i.e. **STREAM** and **RECORD** buttons are solid white.
- Press **RECORD** or **STREAM** button.
- The button LED should behave according to the device's operation mode. The LED behaviors are summarized in the table below:

	Solid red RECORD button	Solid white RECORD button
Solid red STREAM button	Stream & Record	Stream Only Mode
Solid white STREAM button	Record Only Mode	None

- The two buttons turn solid white a few seconds after displaying the operation mode.

Switching operation modes

Follow the steps below to switch to the next operation mode:

- First make sure the stream and record functions are in idle state, i.e. **STREAM** and **RECORD** buttons are solid white.
- Simultaneously press and hold the **RECORD** and **STREAM** buttons for more than 3 seconds but less than 10 seconds.
- As the operation mode switches, both the **RECORD** and **STREAM** buttons turn from solid red, then blinking red and finally to solid white.
- When the **RECORD** and **STREAM** buttons turn solid white, it indicates that the NVS-31 has been switched to the next operation mode successfully.

Note: The order of the operation mode change is Stream & Record → Stream Only → Record Only

Checking the next operation mode

Follow the steps below to check the operation mode next to the NVS-31's current operation mode before switching:

- First make sure the stream and record functions are in idle state, i.e. **STREAM** and **RECORD** buttons are solid white.
- Simultaneously press and hold the **RECORD** and **STREAM** buttons for more than 1 second but less than 3 seconds.
- The button LED should behave according to the device’s next operation mode. The LED behaviors are summarized in the table below:

	Solid red RECORD button	Solid white RECORD button
Solid red STREAM button	Stream & Record	Stream Only Mode
Solid white STREAM button	Record Only Mode	None

- The two buttons turn solid white a few seconds after displaying the operation mode.

Note: The order of the operation mode change is **Stream & Record** → **Stream Only** → **Record Only**

6.5 Restoring Factory Defaults

Execute the following steps to restore the NVS-31’s factory defaults.

- The **RECORD** and **STREAM** buttons are either solid white and solid red, which means the factory defaults can be restored regardless of the state of the device.
- Press and hold the **RECORD** and **STREAM** buttons simultaneously for more than 10 seconds.
- While the NVS-31’s factory defaults are being restored, both the **RECORD** and **STREAM** buttons turn from solid red, then blinking red and finally to solid white.
- When the **RECORD** and **STREAM** buttons turn solid white, it indicates that the NVS-31’s factory defaults have been successfully restored.

6.6 Firmware Update

Datavideo usually releases new firmware containing new features or reported bug fixes from time to time. This section outlines the firmware upgrade process which should take **approximately 10 minutes to complete**.

1. Visit the official product page <https://www.datavideo.com/tw/product/HS-1600T> where you can [download the latest firmware file](#).
2. Login the NVS-31 web interface, then click the **System** tab to open the system configuration page.
3. Scroll down to **Firmware Update** then click the **Browse** button to search for the latest firmware file on the PC’s hard disk.

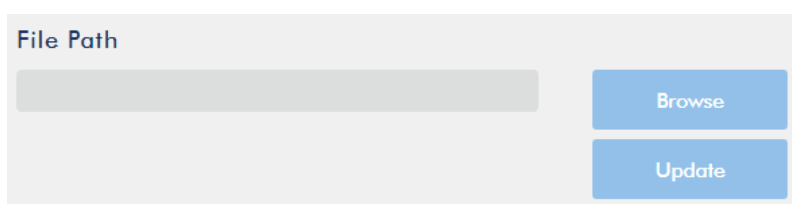

4. After double clicking the firmware file, you will see the loading prompt as shown below, indicating that the file is being uploaded to the NVS-31.

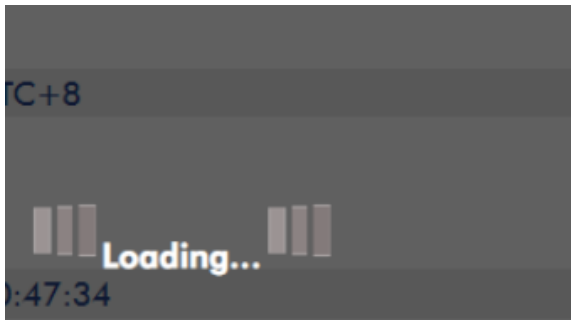

5. After the file has been successfully uploaded, you will see a file upload success message. Click the **Update** button to start the firmware update process.



6. The device will reboot itself after it is updated successfully.

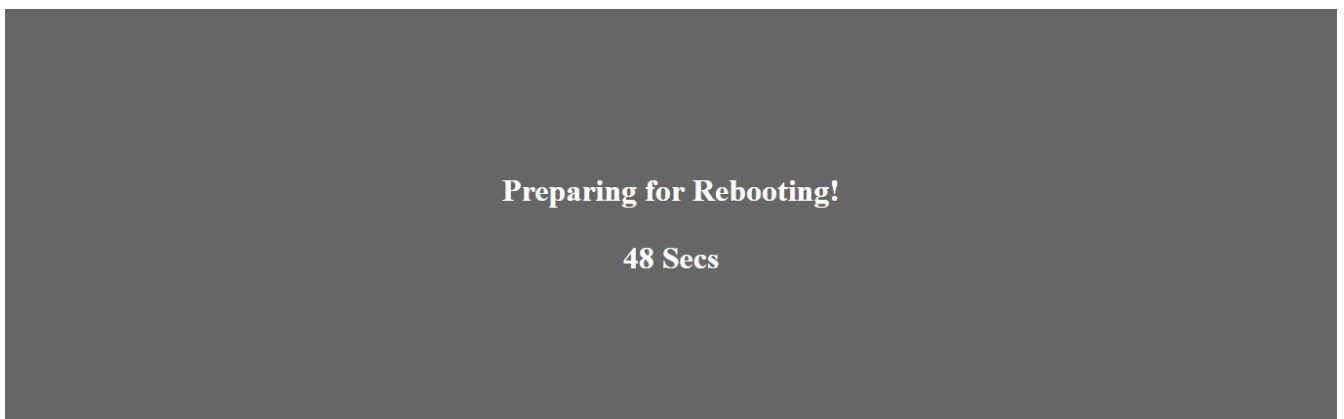

Note: If the device is recording or streaming, you must turn them off before initiating the firmware update.

Recovery Mode

If power outage is experienced while the firmware is being updated and the NVS-31 becomes inaccessible due to incomplete update or corrupt files, you may reboot the HS-1600T then activate the recovery mode to restore the device functionality. Follow the steps below to enter the recovery mode.

- Reboot the HS-1600T
- As the HS-1600T boots, the **STREAM** button turns solid red then press and hold the **RECORD** and **STREAM** buttons simultaneously; release them when the two buttons start flashing red color.
- The NVS-31 starts erasing files of the previous update and uses the previously uploaded file to force the firmware update.
- When the **RECORD** and **STREAM** buttons turn solid white, the firmware update is complete.

Formatting the SD Card

You are also allowed to format the SD card on the HS-1600T. Follow the steps below to format your SD card.

- Insert the SD card into the HS-1600T's SD card slot.
- Login the NVS-31 web interface then click the **Storage** tab to open the storage interface.
- Select the disk storage format from the **Storage Format** drop-down list.

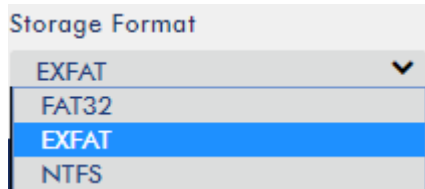

- Click the **Format Storage Disk** button to start SD card formatting. The format is complete when the progress bar reaches 100%.



Chapter 7 Appendices

Appendix 1 Tally Outputs

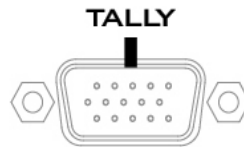

The HS-1600T has a D-sub 15 pin female tally output port. These connections provide bi-colour tally information to a number of other Datavideo products, such as the ITC-100 eight channel talkback system and the TLM range of LCD Monitors. The ports are open collector ports and as such do not provide power to tally light circuits.

The pin outputs are defined as follows:

PIN No.	Signal Name	Input/Output	Description of Signal
1	Program 1	Open collector output	Tally output of input video Program 1
2	--	--	No Function
3	Preview 1	Open collector output	Tally output of input video Preview 1
4	RCOM (GND)	Ground	Ground
5	Program 4	Open collector output	Tally output of input video Program 4
6	Program 2	Open collector output	Tally output of input video Program 2
7	--	--	No Function
8	Preview 2	Open collector output	Tally output of input video Preview 2
9	GND	Ground	Ground
10	--	--	No Function
11	Program 3	Open collector output	Tally output of input video Program 3
12	--	--	No Function
13	Preview 3	Open collector output	Tally output of input video Preview 3
14	YCOM (GND)	Ground	Ground
15	Preview 4	Open collector output	Tally output of input video Preview 4

Appendix 2 Firmware Upgrade (Keyboard / Mainboard)

Datavideo usually releases new firmware containing new features or reported bug fixes from time to time. Customers can either download the HS-1600T firmware as they wish or contact their local dealer or reseller for assistance.

This section outlines the firmware upgrade process which should take **approximately 10 minutes to complete**. The existing HS-1600T settings should persist through the **firmware upgrade process, which should not be interrupted once started** as this could result in a non-responsive unit.

Successful firmware upgrade on HS-1600T requires:

- HS-1600T x 1
- 48V Power adapter x 1
- USB thumb drive x 1
- USB Cable x 1

Update Procedure

1. On the PC, copy the two HS-1600T firmware binary files to the root directory of a USB thumb drive. After the files are successfully copied, safely remove the USB thumb drive from the PC.
 - **HS-1600T.bin**: The HS-1600T Keyboard (KB) Firmware is approximately 27KB and usually with a version number of V1.X.
 - **HS-1600TM.bin**: The firmware file for the HS-1600T Mainboard (MB) and OSD MENU fonts is approximately 2-3 MB (Example of the firmware display is V1.16 for the mainboard and V1.02 for OSD fonts).
2. Connect the USB thumb drive to the F/W Upgrade USB port located on the back of the HS-1600T device.

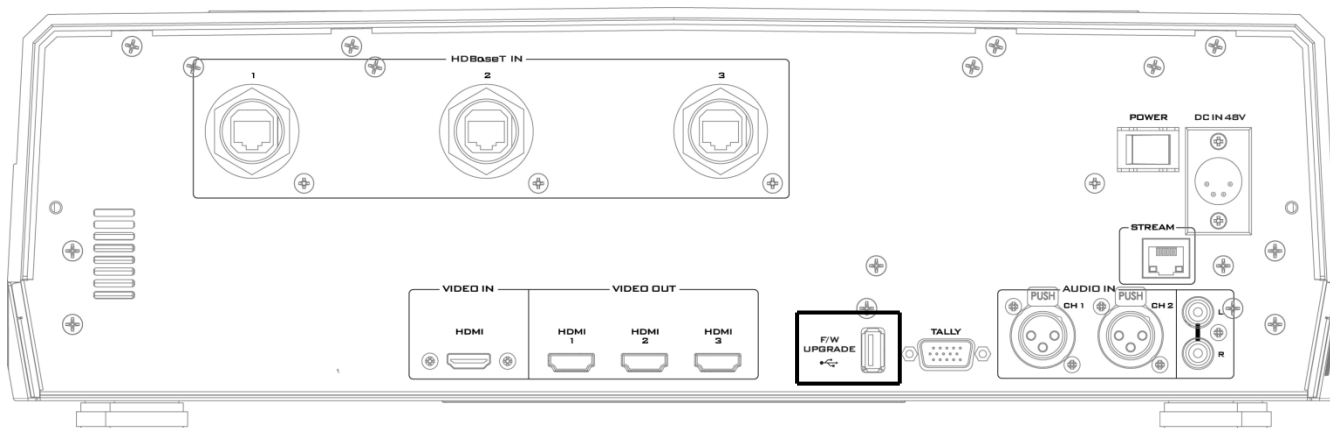

3. Turn on the HS-1600T power.
4. Approximately after 5 seconds, the keyboard firmware will be updated and the update status will be indicated by the LED color of the program row buttons.
 - **Same version number** detected: The firmware will **NOT** be updated and all six buttons should illuminate red.

- **Different version number** detected: The BLK button flashes red twice and the firmware will be updated. All six program row buttons will illuminate red while the firmware is being updated. As soon as the program row buttons are turned off and then turned back on (red) again, the firmware update is complete. The HS-1600T automatically reboots itself after the keyboard firmware is updated.
5. The Mainboard firmware is automatically updated after the Step 4 is executed and the update status will be indicated by the LED color (green) of the preview row buttons. Approximately 5 seconds after the HS-1600T is rebooted, you will see a startup screen on the monitor with old mainboard version (V1.5) displayed at the bottom right corner. At this point, the BLK button will start flashing green. The mainboard firmware update will start approximately 10 seconds after the mainboard finishes booting.

The startup screen on the monitor disappears and the firmware update will be in progress as the preview row buttons are turned on one at a time from left to right until all buttons illuminate solid green after approximately **ONE minute**. At this point, the firmware update is complete and the mainboard will reboot itself. After the HS-1600T finishes booting, the new version number (V1.6) will be displayed at the bottom right corner of the HS-1600T startup screen.

6. The OSD fonts will be automatically updated after the Step 5 is executed and the update status will be indicated by the LED color (green) of the preview row buttons. The machine reboots itself after the mainboard is updated, and the BLK button will start flashing green after the reboot. The OSD fonts update will start approximately 10 seconds after the mainboard finishes booting.

The startup screen on the monitor disappears and the firmware update will be in progress as the preview row buttons are turned on one at a time from left to right until all buttons illuminate solid green after approximately **SIX minutes**. At this point, the monitor should display a four-quadrant Multiview screen and this indicates that the OSD fonts update is complete.

7. The update is finished when all six buttons of the program and preview rows illuminate solid red and green respectively. Remove the USB thumb drive and reboot the HS-1600T.
8. After the machine finishes booting and as soon as you see the Multiview screen, press the MENU button to open the OSD menu to check the MB, OSD and KB versions:
Use the Up/Down arrow buttons to move to the Setup option and check if the firmware is successfully updated:

- MB Software: V1.16.1.02
- KBD Software: V1.2 (HS-1600T)

Note 1: The device will not be damaged even if the USB cable or power is accidentally disconnected while the firmware is being updated; plug the USB thumb drive back in and reboot the device to resume the update process.



Note 2: The USB disk drive system supports FAT / FAT32 formats.

Note 3: There is no guarantee that the HS-1600T supports all USB disks. When you see all buttons of the program and preview rows illuminate pink or greenish pink, this indicates that the disk file read error has occurred. Please try using other USB flash drive brands.









Appendix 3 Recommended SD Cards

You should only use Class 10 SD card or above. In this appendix, you will find a list of SD cards recommended by Datavideo.

Recommended SD Cards			
No.	Brand	Model	Pictures
1	Kingston	SDHC I C10 16G	
2	SANDISK Extreme	SDXC I C10 U3 V30 64GB	
3	SONY	SDXC I C10 U1 64GB	
4	SANDISK Extreme PRO	SDXC I C10 U3 128GB	 
5	SONY	SDXC I C10 U3 64GB	
6	TOSHIBA	SDHC C10 16GB	

7	SANDISK Extreme	SDHC C10 16GB	
8	ADATA Premier Pro	microSDXC I UHS-I U3 Class 10 with SD adapter 64GB	
9	SANDISK ULTRA®	SDHC™/SDXC™ UHS-I 128 GB	

Compatible SD Card for Mobile Cast and NVS-33

- Kingston**
SDHC C10
16GB

- SANDISK Extreme**
SDXC C10 U3 V30
64GB

- SONY**
SDXC C10 U1
64GB

- SANDISK Extreme PRO**
SDXC C10 U3
128GB

- SONY**
SDXC C10 U3
64GB

- TOSHIBA**
SDHC C10
16GB

- SANDISK Extreme**
SDHC C10
16GB

- ADATA Premier Pro**
microSDXC UHS-I U3 Class 10
64GB

- SANDISK ULTRA SDHC**
SDXC UHS-I
128GB

Appendix 4 Frequently-Asked Questions

This section describes problems that you may encounter while using HS-1600T. If you have any questions, please refer to related sections and follow all suggested solutions. If problem still exists, please contact your distributor or the service center.

No.	Problems	Solutions
1.	Audio is switched only after the transition is complete.	It is normal that audio is switched after the transition is complete regardless of the transition method (T-Bar or Auto) used.
2.	What are the recommended SD card classes?	Use any of the SD Card Classes C10/U1/V10.
3.	a. Why am I still seeing lag delay in the video recorded on SD Card Class C10?	a. This could be due to unoptimized disk formatting. Format your disk on the NVS-31 or using the tool downloaded from the SD association's official website (https://www.sdcard.org/cht/downloads/formatter_4/index.html).
	b. In this case, why doesn't the system issue any error messages upon the start of video recording?	b. The system detects and sets write speed upon the start of video recording and because insufficient write speed is experienced during video recording so the system does not issue an error message.
4.	Jitter is seen on moving images.	Please make sure the input and output are set to the same resolution and frame rate.
5.	A few important things to note about operating the NVS-31.	Because the NVS-31 UI is not updated in real time so the UI status display may not reflect the current device status. As a result, whether the device is operated on the panel, on the UI or both, please refresh the status page from time to time to make sure the information displayed is the latest. You should also constantly monitor your video recording and streaming at the same time.

Appendix 5 Tips for Establishing an HDBaseT Compliance Environment and Ethernet Cable Selection

Tips for Establishing an HDBaseT Compliance Environment

HDBaseT alliance defines the maximum number of cables in a bundle use case to be six cables per bundle. Table below defines the maximum number of cables in a bundle as a function of cable type & the overlapping length.

HDBaseT Cabling-Permissible Number of Cables in a Bundle

Type	30m	50m	70m	100m
CAT5e/6	6	4	2	1
CAT6a/7	6	6	6	6

The following installation practices can help to withstand the external interference when using CAT5e/6 cables:

- A) Do not “comb” or “pinstripe” cables in the first 20 meters.
- B) Use separate patch and equipment cords in the first 20 meters.
- C) Avoid use of tie-wraps.
- D) Use horizontal wire management techniques. For example, route odd ports to upper management and even ports to lower management.
- E) Loosely place cables in vertical wire management.
- F) Reduce maximum conduit fill density to 40%.
- G) It is recommended to roll the cable around a fixed radius drum in an orderly manner. This is shown on the left hand side of below. When the turns are ordered, the electromagnetic coupling between the various sections that occurs in a randomly rolled cable is reduced. The FEXT impairment level measured when rolling an Ethernet cable around a 70 cm fixed diameter plastic drum is only slightly higher than that of a fully stretched cable.

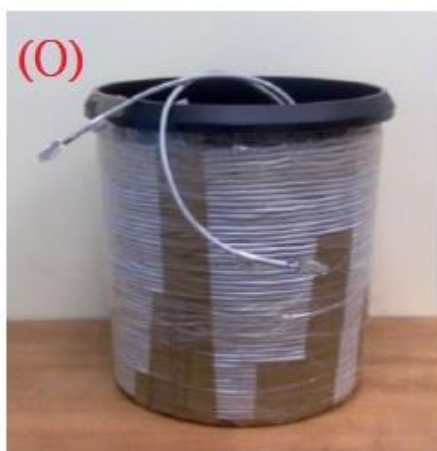

Tips for Establishing an HDBaseT Compliance Environment Outdoors/for the Strong Interference Environment

1. If customers want to establish an HDBaseT compliance environment outdoors, it is recommended that customers can use the UV resistant Ethernet cable to make sure that the Ethernet cable achieves its best connection quality. Generally speaking, the outdoor UV resistant Ethernet cable is coated with the black PE skin.

2. If there is any interference source at the customer side such as the radio interference, it is highly recommended to adopt the SFTP* to prevent the Ethernet cable from interference.

*SFTP: The SFTP (Shielded and Foiled Twisted Pair) is an Ethernet cable with foil shielding around the individual twisted wires and an overall shield which can be a flexible braid. This provides highest protection for the Ethernet cable to prevent it from interference.

Tips for the Ethernet Cable Selection for the HDBaseT System & Camera Connection

1. Please use the solid conductors rather than the stranded conductors for the HDBaseT system network connection due to that the solid conductors have better electrical performance than the stranded conductors.

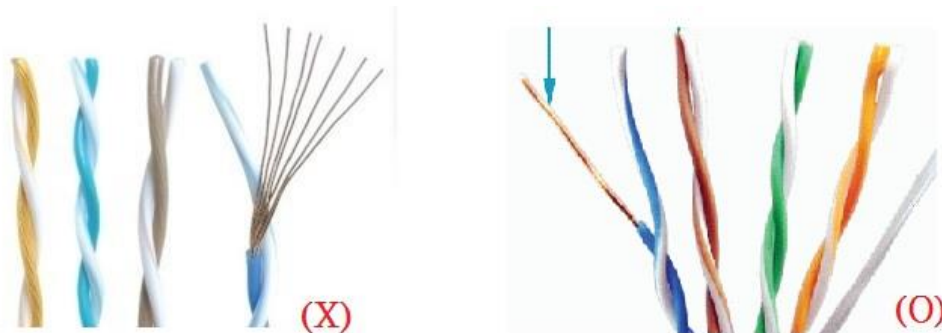

2. Please Do NOT use the flat ethernet cable due to following reasons.

A) There is no twisted paired inside the flat ethernet cable to offset the interference.

B) There is no cross-spacer between the cables inside the flat ethernet cable.

C) The diameter of each core cannot meet the AWG standard due to cut corners.

- For the CAT5e cable, the diameter for most of the flat Ethernet cables cannot meet the 24AWG (0.49~0.51mm) standard and the bandwidth cannot meet the 125MHz standard.
- For the CAT6/CAT6a cable, the diameter for most of the flat Ethernet cables cannot meet the 23AWG standard and the bandwidth cannot meet the 250MHz standard.
- For the CAT7 cable, the diameter for most of the flat Ethernet cables cannot meet the 22AWG standard and the bandwidth cannot meet the 600MHz standard.

D) For many of the multicore Ethernet cables, the solid conductor for each core is made by the aluminum wire, copper-clad aluminum wire or copper-clad steel wire rather than the anaerobic copper wire.

3. Please visit the website "<http://hdbaset.org/hdbaset-recommended-cables/>" for the ethernet cable providers that are verified by the HDBaseT alliance.

4. For more information about how to establish the HDBaseT environment and details of usage, please visit and register on the website "<http://hdbaset.org/installers/>" to get the free membership.

Appendix 6 Dimensions

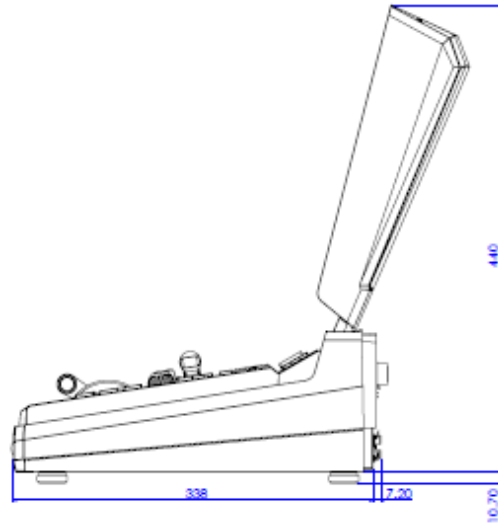
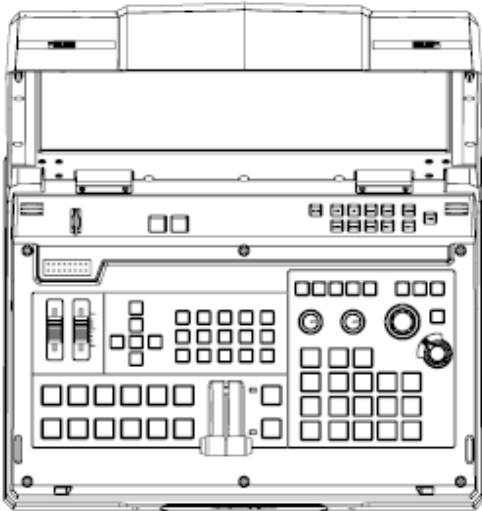
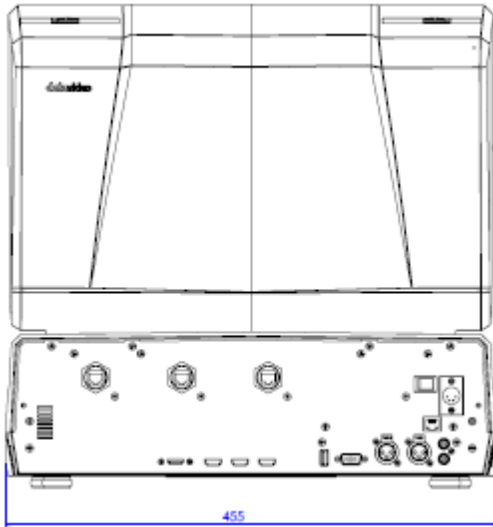

All measurements in millimeters (mm)

Appendix 7 Specifications

Model Name	HS-1600T
Product Name	4-Channel HD/SD HDBaseT Portable Video Streaming Studio
Video Standard	HD & SD
Video Format	1080p 50/59.94/60Hz 1080i 50/59.94/60Hz 720p 50/59.94/60Hz 576i/p 50Hz 480i/p 59.94Hz
Input Routable / Crosspoint	N/A
Video Input	3 x HDBaseT 1 x HDMI
Computer Graphical Interface	1 via HDMI
Down-Converted Output	Yes
Video Output	3 x HDMI PGM 1 x STREAM (RJ-45)
Audio Input	2 x Balanced XLR 1 x Stereo RCA (L/R) De-embedded Digital Audio
Audio Output	1x Stereo headphone
Embedded Audio Support	2 CH Audio embedded
Audio Delay Calibration	N/A
A+V Switching	N/A
USK	1x USK Lumakey support
DSK	N/A
Picture in Picture	1
Logo Insertion	N/A
Built-in Audio Mixer	Yes
Built-in Monitor Display	17.3" HD TFT LED backlit, 1920x1080 pixels
Built-in Intercom & Tally	N/A
Streaming Video Encode	H.264 / AVC, Main/ High Profile Configurable Bit-rate up to 10Mbps
Streaming Audio Encode	AAC-LC Configurable bit rate ranging from 32Kbps to 384Kbps Sample rate: 48KHz, 16bit

Streaming Protocol	TS over TCP/UDP (unicast & multicast) RTSP over HTTP/TCP/UDP (RTSP Elementary Streaming) RTMP (Publish)
Streaming Control	Web browser UI for configuration and control Socket commands
Recording File System	FAT, exFAT, NTFS
Recording File Format	MP4
Recording Setting Control	Web UI for system configuration and control
Dimensions (LxWxH)	455 x 355 x 134 mm
Weight	17.2 Lbs (7.8 Kg), Reinforce Plastic Case
Accessory	CB-60/61/62

Service & Support

It is our goal to make owning and using Datavideo products a satisfying experience. Our support staff is available to assist you to set up and operate your system. Contact your local office for specific support requests. Plus, please visit www.datavideo.com to access our FAQ section.



Please visit our website for latest manual update.

www.datavideo.com/product/HS-1600T

datavideo
www.datavideo.com



@DatavideoUSA @DatavideoIndia2016
@DatavideoEMEA @Datavideojapan
@DatavideoTaiwan @DatavideoLatam
@DatavideoAsia @DatavideoBrasil



@Datavideo
@Datavideo_EMEA
@Datavideo_Taiwan



@DatavideoUSA
@DVTWDCN



@DatavideoUSA
@DatavideoEurope

All the trademarks are the properties of their respective owners.
Datavideo Technologies Co., Ltd. All rights reserved 2020

Jul-26.2019
Version E3