

HB-T-SDI, HB-R-SDI Mini-Converters

SDI to HDBaseT



Installation and Operation Guide

Version 1.0r3
Published May 1, 2018



Notices

Trademarks

AJA® and Because it matters.® are registered trademarks of AJA Video Systems, Inc. for use with most AJA products. AJA™ is a trademark of AJA Video Systems, Inc. for use with recorder, router, software and camera products. Because it matters.™ is a trademark of AJA Video Systems, Inc. for use with camera products.

CION®, Corvid Ultra®, Io®, Ki Pro®, KONA®, KUMO®, ROI® and T-Tap® are registered trademarks of AJA Video Systems, Inc.

AJA Control Room™, KiStor™, Science of the Beautiful™, TruScale™, TruZoom™, V2Analog™ and V2Digital™ are trademarks of AJA Video Systems, Inc.

All other trademarks are the property of their respective owners.

Copyright

Copyright © 2018 AJA Video Systems, Inc. All rights reserved. All information in this manual is subject to change without notice. No part of the document may be reproduced or transmitted in any form, or by any means, electronic or mechanical, including photocopying or recording, without the express written permission of AJA Video Systems, Inc.

Contacting AJA Support

When calling for support, have all information at hand prior to calling. To contact AJA for sales or support, use any of the following methods:

Telephone	+1.530.271.3190
FAX	+1.530.271.3140
Web	https://www.aja.com
Support Email	support@aja.com
Sales Email	sales@aja.com

Contents

Notices	2
Trademarks	2
Copyright	2
Contacting AJA Support	2
Chapter 1 – Introduction	4
Overview	4
Features	4
Simplified Block Diagrams	5
I/O Connections	5
Installation	6
Pairing SDI and HDMI HDBaseT Converters	7
CAT Cable Types	7
Chapter 2 – Operation	8
USB Control and Setup—Using AJA Mini-Config	8
Acquiring Mini-Config	8
Installing Mini-Config	8
Running Mini-Config	10
Operating Mini-Config	11
Tabbed Screens	12
HB-T-SDI Input Tab Screen	13
HB-R-SDI Input Tab Screen	14
HB-T-SDI Output Tab Screen	15
HB-R-SDI Output Tab Screen	16
HB-T-SDI Audio Tab Screen	17
HB-R-SDI Audio Tab Screen	18
Update Tab Screen	19
Info Tab Screen	20
Appendix A – Specifications	21
HB-T-SDI Tech Specs	21
HB-R-SDI Tech Specs	22
Appendix B – Safety and Compliance	24
Warranty and Liability Information	32
Limited Warranty on Hardware	32
Limitation of Liability	33
Governing Law and Language; Your Rights	33
Index	34

Chapter 1 – Introduction



Overview

The HB-T-SDI and HB-R-SDI convert SDI Video/Audio/Control signals for transmission/reception via HDBaseT over CAT type twisted pair cable. These units provide simple and economical video/audio transmission over distances up to 330 feet/ 100 meters. See "[Appendix A Specifications](#)" on page 21 for a complete list of supported formats, frame rates, and CAT cable requirements.

HB-T-SDI and HB-R-SDI support bi-directional IR and RS-232 for device control, making them ideal for applications such as:

- Fixed installation AV
- Digital signage
- Live events
- Post production/network/studio environments
- On-set environments

Features

- HDBaseT Certified 4K/UltraHD Signal Extender
- Extend uncompressed 2K, HD, or SD SDI signal up to 100m over Ethernet cable
- Extends bi-directional IR and RS-232 on the same Ethernet cable
- Support for PCM 2 CH, LPCM 5.1, LPCM 7.1
- Support for Dolby Digital, Dolby Digital Plus, Dolby TrueHD, Dolby Atmos, DTS Digital Surround and DTS-HD Master Audio
- 5-20VDC power supply (included)
- Optional I/R and RS232 cable kit (HB-Cable-Kit)
- 5-year warranty
- Mini-Config application control

Simplified Block Diagrams

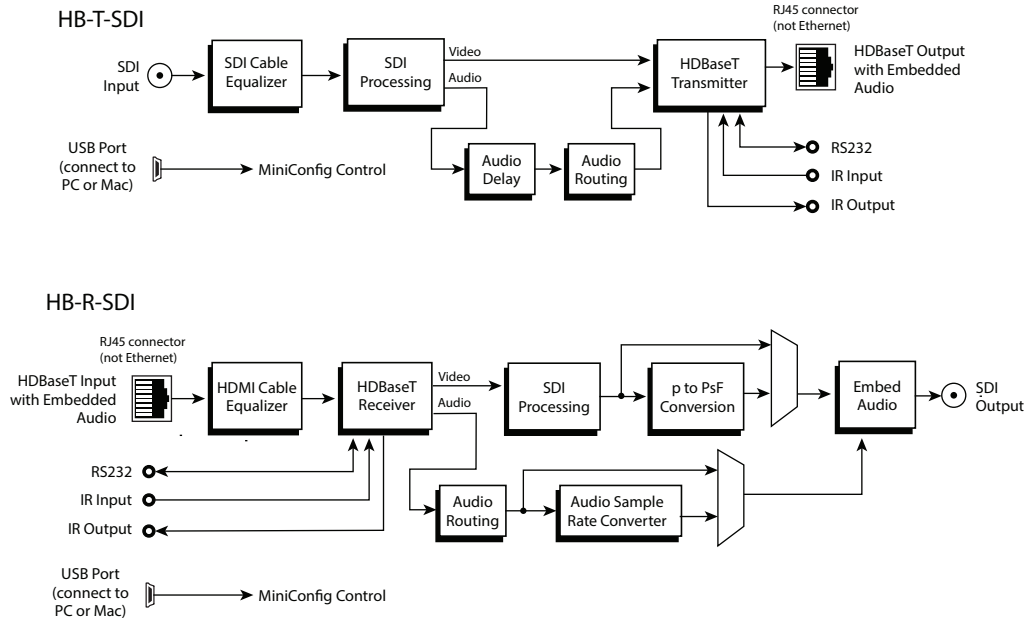

I/O Connections

Figure 1. HB-T-SDI Mini-Converter



Figure 2. HB-R-SDI Mini-Converter



NOTE: The LOCK LED indicates valid input video by color. Off is no signal, green is SD video, red is HD video, amber is 3G video.

Installation

Figure 3. Typical System Interconnect Diagram

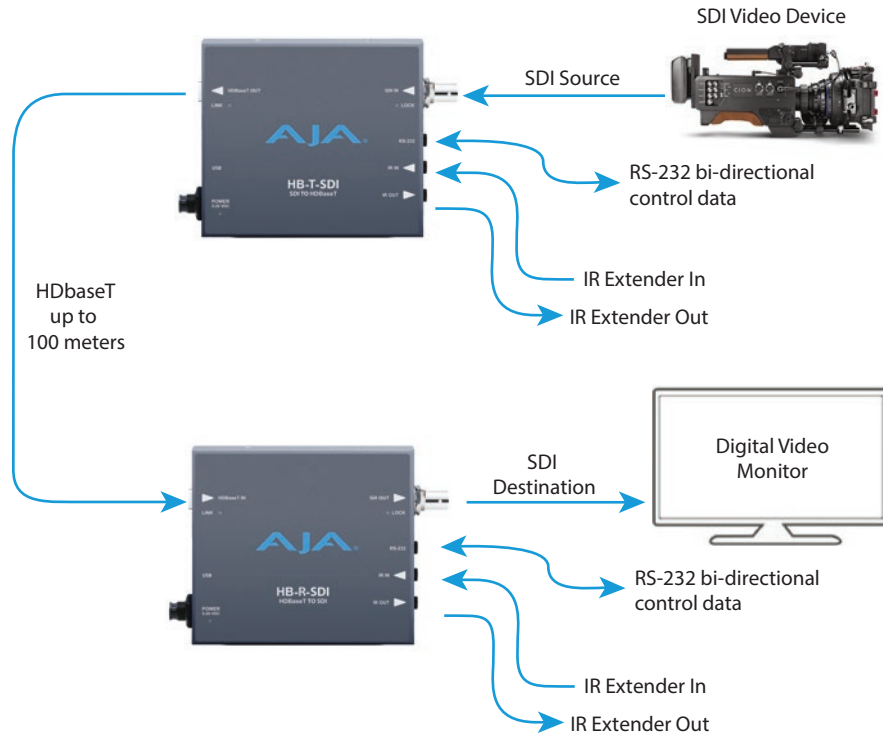

Typically, HB-T-SDI & HB-R-SDI installation consists of the following steps:

1. Ensure the converters are disconnected from power.

2. Connect the SDI source signal to the SDI input connector of the HB-T-SDI and the transmission CAT cable to the HDBaseT output connector.
3. Connect the other end of the CAT cable to the HDBaseT input connector on the HB-R-SDI.
4. Connect RS-232 and IR input/output extension cables to the 1/8" TRS connectors (optional cable kit is available from AJA).
5. Apply power to the converter (AJA power supply included).
6. The converter will now run using the default factory settings. If you wish to alter the factory settings, you'll need to:
 - Install the AJA Mini-Config software onto your computer.
 - Attach the converter via USB cable (included).
 - Make your changes using Mini-Config setup screens.

Pairing SDI and HDMI HDBaseT Converters

An HB-T-SDI model Mini-Converter can operate paired with an HB-R-HDMI model Mini-Converter, and an HB-T-HDMI can pair with an HB-R-SDI, provided the input and output video formats are compatible. For example, you can transport HD video between these HDMI/SDI pairs, but you cannot transport 4K/UltraHD video (which SDI models do not support). 4K/UltraHD video can be transported between a pair of HDMI Model Mini-Converters, however. Mini-Config controls available on the SDI models can be used to match color space and other settings. The HDMI models do not support Mini-Config.

CAT Cable Types

The cable types in the table below are recommended for maximum performance reach and full-capacity by the HDBaseT Alliance.

Table 1. Recommended Cables for HD video transmission

Type	Manufacturer	URL
CAT7 S/FTP	Teldor	http://www.teldor.com/
CAT6A H/STP	Teldor	http://www.teldor.com/
CAT.7	Earthline	http://products.lappgroup.com/online-catalogue/data-communication-systems-for-ethernet-technology/

NOTE: For detailed performance specifications of cable types at supported Display Resolutions, see "[HDBaseT Cable Run Performance for 4K/UltraHD/HD](#)" on page 24.

Chapter 2 – Operation

USB Control and Setup—Using AJA Mini-Config

Your AJA Mini-Converter can be used right out of the box for some applications since it is designed to recognize inputs and perform standard actions automatically by default. However, to use its full capability, you must use AJA's Mini-Config software application for PCs and Macs. This same application can be used to update to new Mini-Converter software released by AJA.

NOTE: DIP switch 1 must be ON (Remote, Right) to permit Mini-Config control of the unit.

Acquiring Mini-Config

AJA's Mini-Config application is available for download from the AJA website.

To download the latest Mini-Config package, which includes the Mini-Config application, Mini-Converter firmware, and documentation, go to:

<https://www.aja.com/products/mini-converters/mini-config-software>

Select either the Windows or Mac icon to download the desired version.

Mini-Converter Documentation

Included with the Mini-Config package is a complete set of documentation for all Mini-Converters supported by Mini-Config. A .PDF of the *Installation and Operation Guide* for the currently connected Mini-Converter can be accessed from the Mini-Config UI via the **Help/Manual** drop-down menu.

Documentation for all AJA Mini-Converters that use Mini-Config can also be accessed directly in the Mini-Config download package Documentation folder, and via the Documentation icon available on the Mac installer.

Documentation (and firmware) included with the Mini-Config application are the versions available at the time of distribution. However, Mini-Converter software, firmware and documentation are updated regularly, so newer versions may exist.

To download the latest documentation for an individual Mini-Converter, go to:

<https://www.aja.com/category/mini-converters>

and navigate to the Support web page of that Mini-Converter.

Installing Mini-Config

PC Installation

To install Mini-Config on a Windows PC:

1. Download the application from the AJA website (select the Windows icon on the Mini-Config Support web page).
2. Open the AJA_MiniConfig.zip file
3. Double-click on the **MiniInstaller.msi** file.
4. A Setup Wizard will guide you through the installation.

Figure 4. Mini-Config PC Setup Wizard

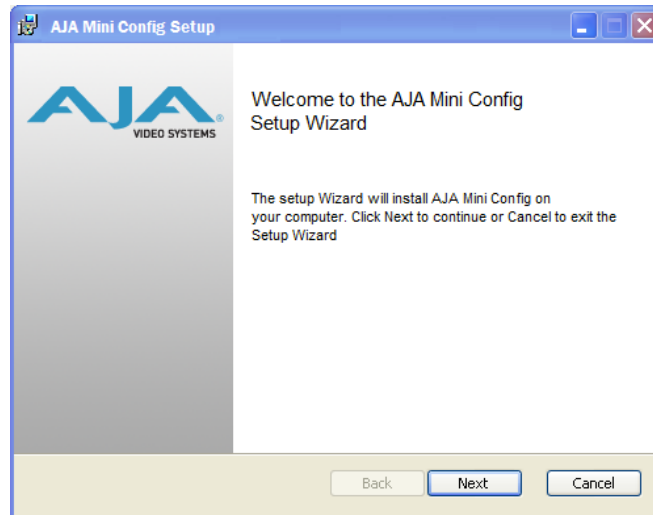

5. Click **Next** to begin. Answer the questions in the subsequent dialogs. When finished, an AJA Mini-Config shortcut will be installed on the desktop, and you will be able to locate the Mini-Config application in the AJA folder in the Programs listing.

NOTE: If the Mini-Config application already exists on the PC, a different Setup Wizard appears.

Figure 5. Mini-Config Setup Wizard, Reinstallation

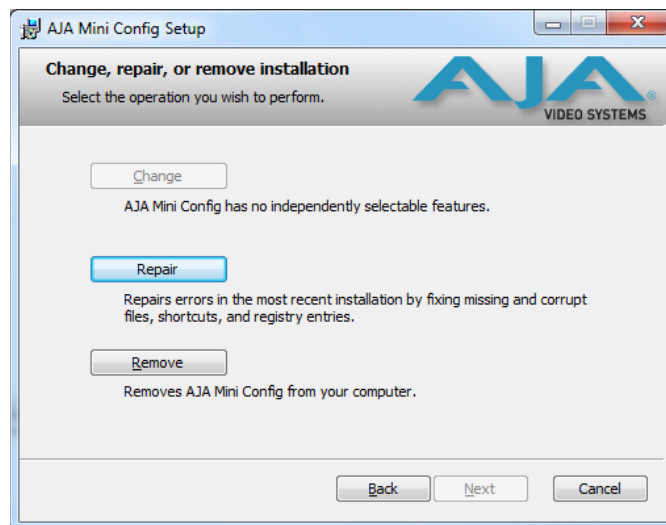

With this screen you can **Repair** (reinstall) or **Remove** (uninstall) Mini-Config on the PC.

Mac Installation

To install the application on a Mac:

NOTE: Mac computers must be Intel-based (G5, G4 and earlier models will not work with Mini-Config).

1. Download the application from the AJA website (select the Apple icon on the Mini-Config Support web page).
2. Open the AJA_MiniConfig folder.
3. Double-click on the **AJAMiniConfig.dmg** file.

4. Answer the prompt and a utility program will be launched.

Figure 6. Mini-Config Mac Installer

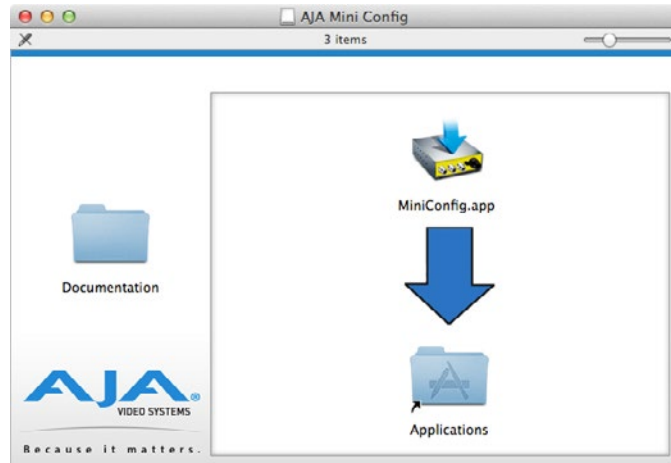

5. To complete the installation drag the **MiniConfig.app** icon to the Applications folder.

Running Mini-Config

Connect the Mini-Converter to the PC or Mac via the supplied USB cable. Connect the external power supply (supplied) to the Mini-Converter.

PC Startup

To run Mini-Config on a PC, double-click on the AJA Mini-Config icon on your desktop, or open the AJA folder in the program list and click on the AJA Mini-Config application located inside the Mini-Config folder.

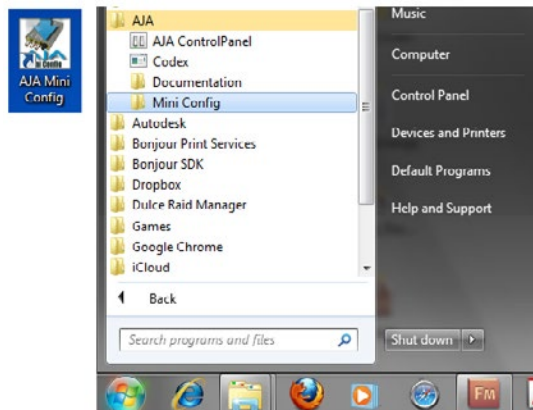

Mac Startup

To run Mini-Config on a Mac, open the Applications folder and locate the AJA Mini-Config application. Double-click the application to launch it.

Saving Setups

A **File** drop down menu on the Mini-Config application bar allows you to save the current state of the Mini-Converter to a preset file for later recall.

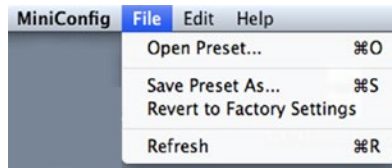

Using this feature you can set up the converter for different applications, storing each configuration (**Save Preset As...**) with a unique name for easy recall (**Open Preset...**).

A **Revert to Factory Settings** menu item similarly allows you to change the settings back to AJA's factory defaults.

Operating Mini-Config

The Mini-Config application provides a graphic interface for viewing settings and updating software. It consists of an information area at the top that shows the available Mini-Converters attached to the computer via USB, with a graphical rendering of the selected Mini-Converter showing all the connectors and their current state.

Colored text next to the connectors indicates the signal type and what the Mini-Converter is doing:

- Blue text indicates the values automatically selected
- Black text indicates values that you have manually selected
- Red text indicates the Mini-Converter is not detecting a signal, or cannot operate with the current user settings.

NOTE: Even if no output device is detected, the SDI connector text still shows the signal it is outputting.

NOTE: Configuration settings in red will change based on the attached output device as well as input signals. For improved accuracy and reliability, you should configure the Mini-Converter only when the target output device is attached and input signals are supplied at the inputs.

Screens are virtually the same on both PC and Mac, with subtle differences that reflect the general look of the platform environment.

Figure 7. Example Mini-Config Screen

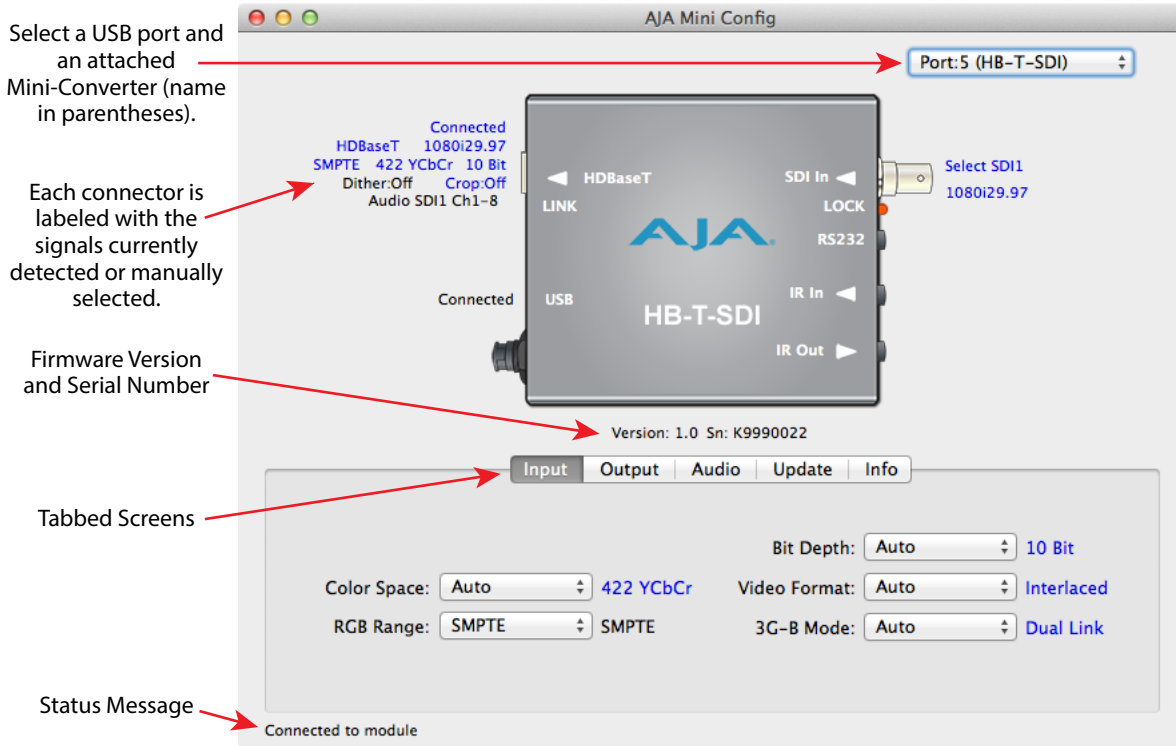

Selecting a Mini-Converter with the pulldown menu causes this application to connect to the selected converter. The graphic of Mini-Converter and text below it provides:

- Type of converter
- Firmware version
- Serial number of the unit.

A status field at the bottom of the screen shows if your application is connected and communicating with the Mini-Converter.

When configuring the Mini-Converter, select it from the top pulldown, view the current settings and change any values. Making a change communicates that new value to the Mini-Converter's non-volatile memory.

Tabbed Screens

The Tabs delineate control screens with groups of controls for each type of task to be performed.

The controls for the actual configuration parameters are specific to each Mini-Converter type. When you Click on any of the tab buttons, the pane below the tabs will change to match your tab selection. Any changes you make are immediately applied and will be saved, overwriting previous settings.

HB-T-SDI Input Tab Screen

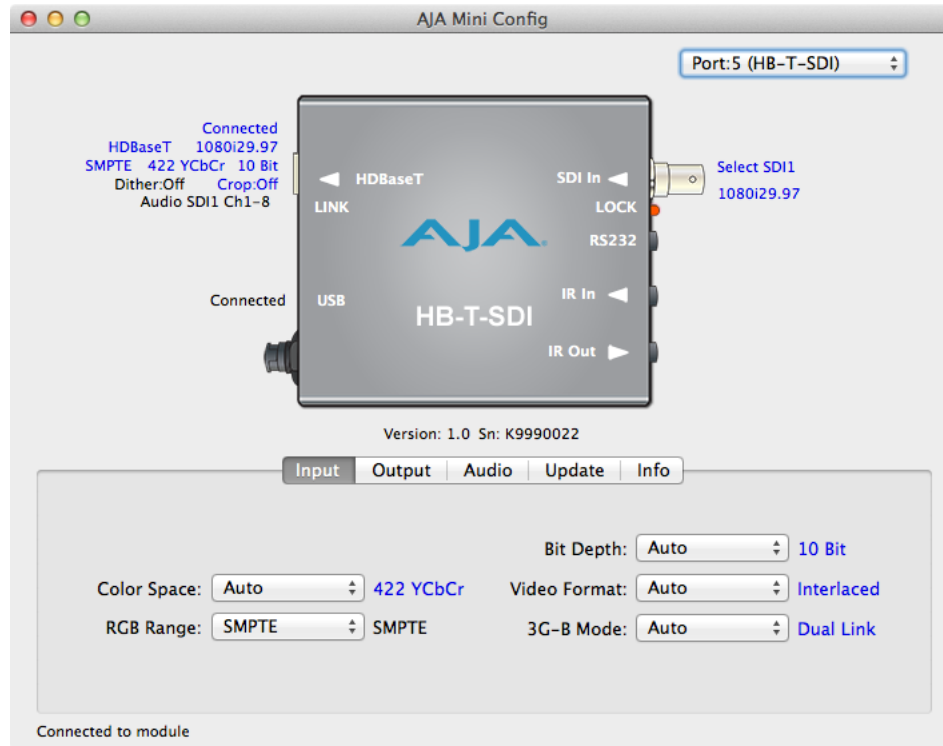

NOTE: Selecting the default Input settings (Auto, SMPTE) when using a pair of HB-T-SDI and HB-R-SDI Mini-Converters is probably best. However, if you pair an HB-T-HDMI or HB-R-HDMI with a corresponding SDI model, having these settings available can become useful. For example, if you connect an HDMI source with a mismatched color space for the SDI destination, you can adjust it using the HB-R-SDI Mini-Config Input screen.

Color Space

Selects the input video color space.

- Auto (default) - Automatically selects color mode based on the input video parameters and the payload ID.
- 422 YCbCr
- 444 RGB
- 444 YCbCr.

RGB Range

Selects the input video color range.

- SMPTE (default)
- Full Range

NOTE: The RGB range setting effects input range only when in RGB mode. YCbCr inputs are always SMPTE levels.

Bit Depth

Selects the input video bit depth.

- Auto (default) - automatically selects the bit depth based on the input video parameters and payload ID.
- 8-bit
- 10-bit
- 12-bit

Video Format

Selects the Input Video Format.

- Auto (default) - automatically selects the format based on the input video parameters and the payload ID.
- Progressive (P)
- Interlaced
- PsF (progressive segmented frame).

3G-B Mode

Selects the 3G level B Video Mode.

- Auto (default) - automatically selects the format based on the input video parameters.
- Dual Link - select this when your 3G signal is 444 or uses 12 bit data.

NOTE: The following two settings only apply to 3G-B video in Dual Stream mode.

- 1 x HD DS1 - use only Data Stream 1 as a single video.
- 1 x HD DS2 - use only Data Stream 2 as a single video.

HB-R-SDI Input Tab Screen

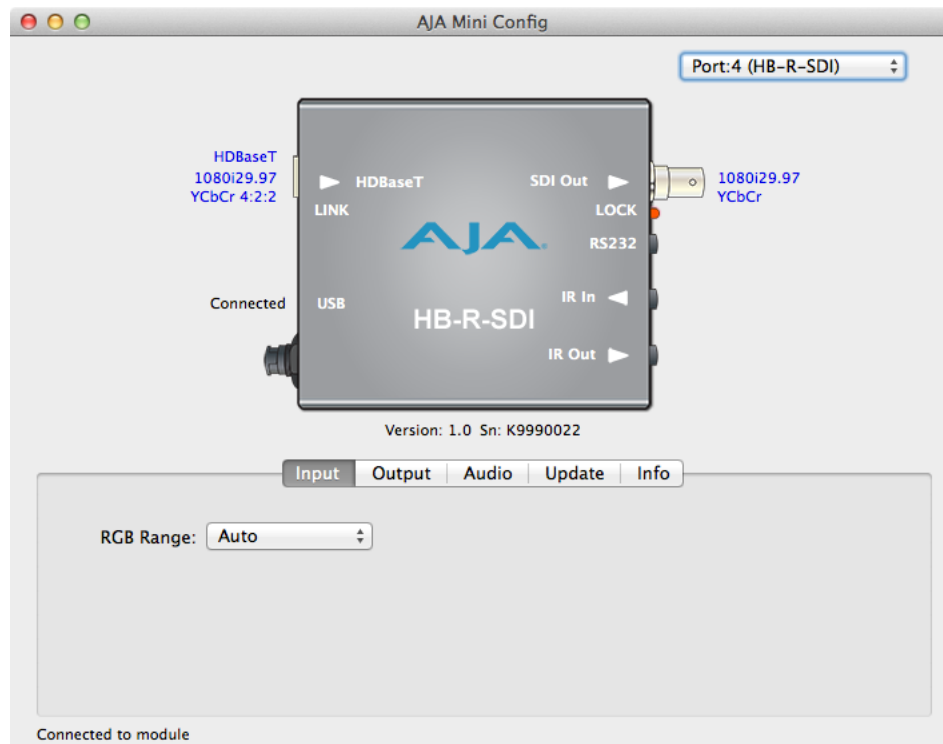

RGB Range

Selects the Input Video Color Range.

- Auto (default)
- SMPTE
- Full color range

HB-T-SDI Output Tab Screen

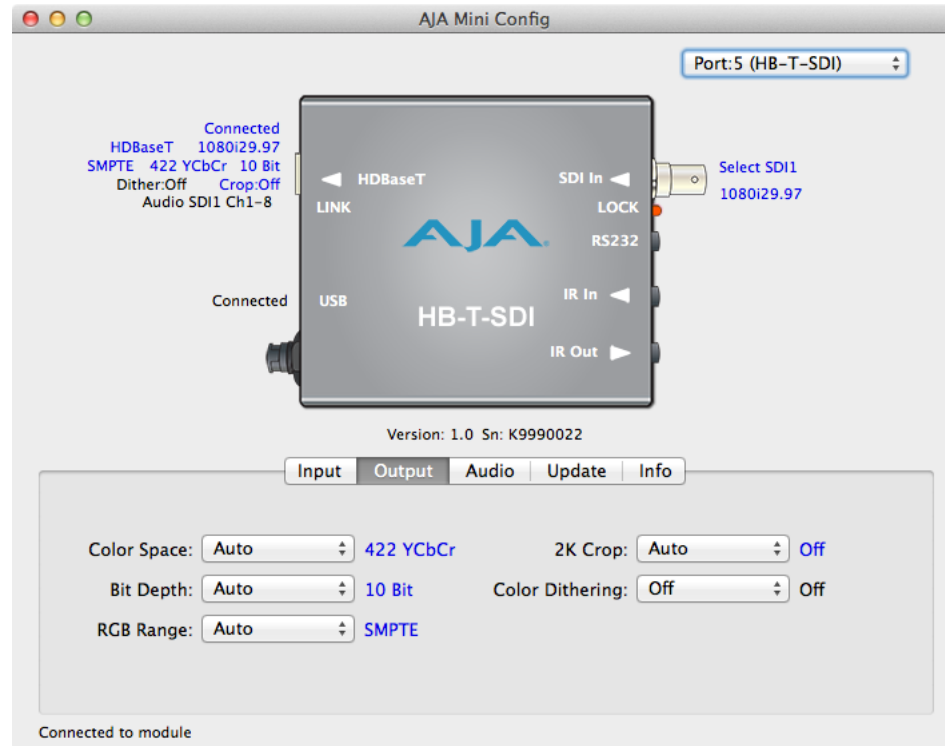

NOTE: Selecting the default Output settings (Auto, Off) when using a pair of HB-T-SDI and HB-R-SDI Mini-Converters is probably best. However, if you pair an HB-T-HDMI or HB-R-HDMI with a corresponding SDI model, having these settings available can become useful. For example, if you connect an SDI source with a mismatched color space for the HDMI destination, you can adjust it using the HB-T-SDI Mini-Config Output screen.

Color Space

- Auto (default) - Automatically selects the format based on the input video.
- 4:2:2 YCbCr
- 4:4:4 RGB
- 4:4:4 YCbCr

Bit Depth

- Auto (default) - Automatically selects the bit depth based on the input video.
- 8-bit
- 10-bit
- 12-bit

RGB Range

- Auto (default) - Automatically selects the output color range setting.
- SMPTE
- Full

NOTE: The RGB range setting effects output range only when in RGB mode. YCbCr outputs are always SMPTE levels.

2K Crop

Provides the option of center cutting 2Kx1080 video signals to make 1920x1080. This has no effect when input video is 1920 pixels per line.

- Auto (default)
- Off
- On

Color Dithering

- Off (default)
- On

HB-R-SDI Output Tab Screen

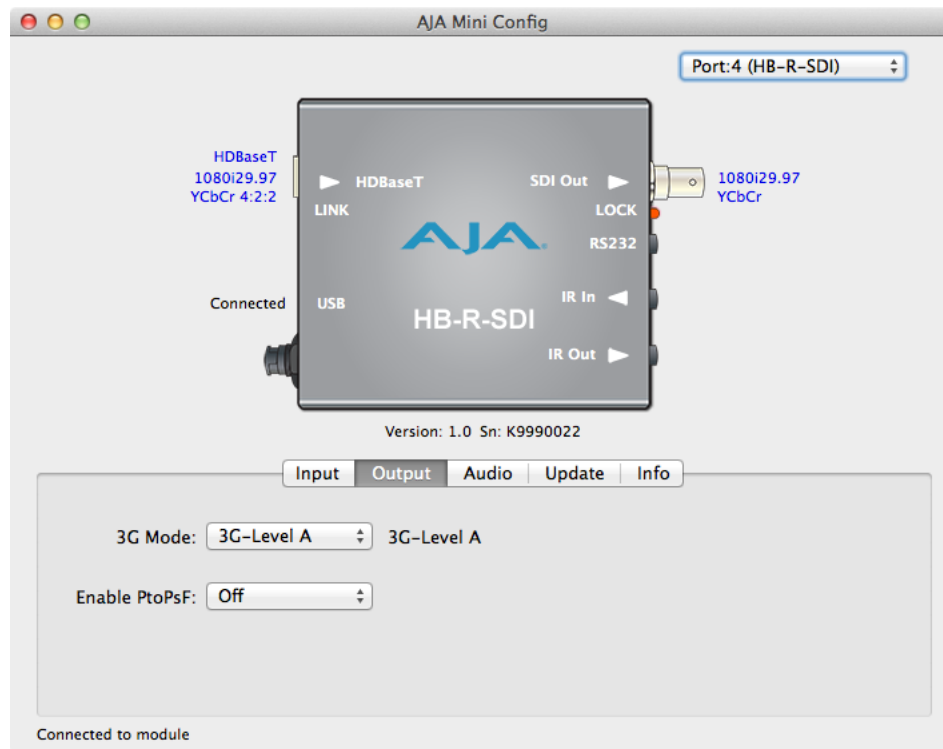

3G Mode

Selects the type of 3G SDI output.

- 3G-Level A
- 3G-Level B.

NOTE: The 3G Mode parameter only has an effect if the output is 3G-SDI.

Enable PtoPsF

This control selects whether progressive video is converted to PsF output.

- Off (default)
- On

NOTE: The Enable PtoPsF parameter only has an effect if the input is 1080p 23.98, 24, 25, 29.97, or 30.

HB-T-SDI Audio Tab Screen

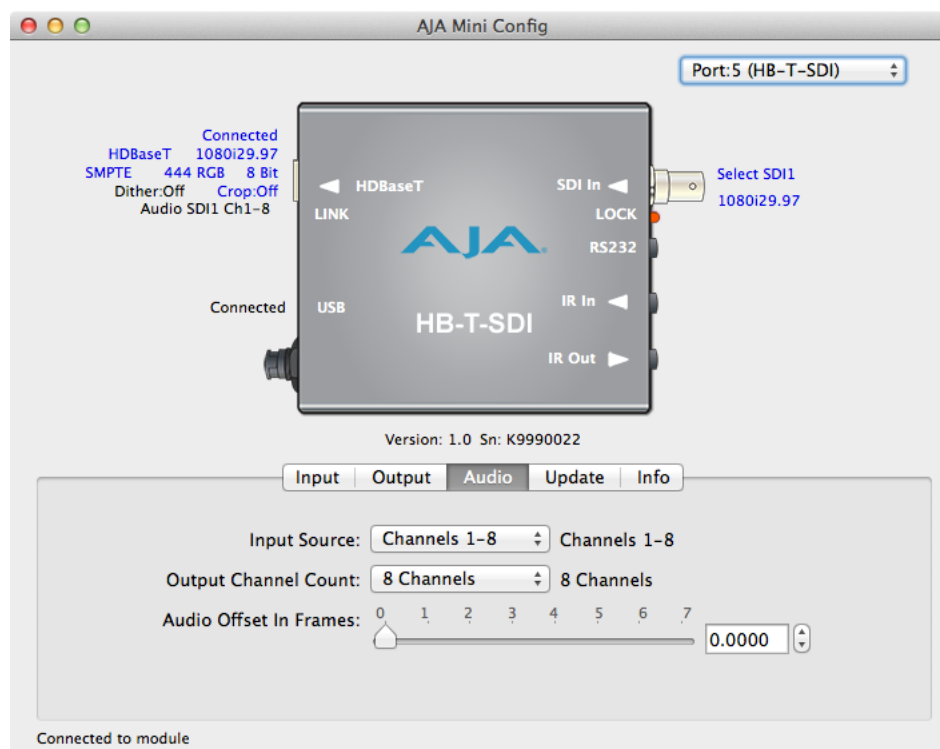

Input Source

Choose which embedded audio channels are routed to the output. Eight channels are routed at a time.

- Channels 1-8 (default)
- Channels 9-16

Output Channel Count

- Auto (default) - Automatically selects the audio channels based on the input.
- 2 of 8 Channels (Ch 1 and Ch 2)
- 8 Channels

Audio Offset In Frames

Permits time shifting the embedded audio in relationship to the video (for example, to correct for lip sync problems), in 1/16 of a frame increments. Range is from 0 to +7 video frames. The actual time duration of delay will vary depending on the frame rate of the format being converted.

Default offset value is 0 frame to match the video delay path, resulting in time-aligned audio on the output. Positive offset delays the audio additional frames (relative to the video output).

NOTE: One frame of delay is automatically added when the input video is PsF.

HB-R-SDI Audio Tab Screen

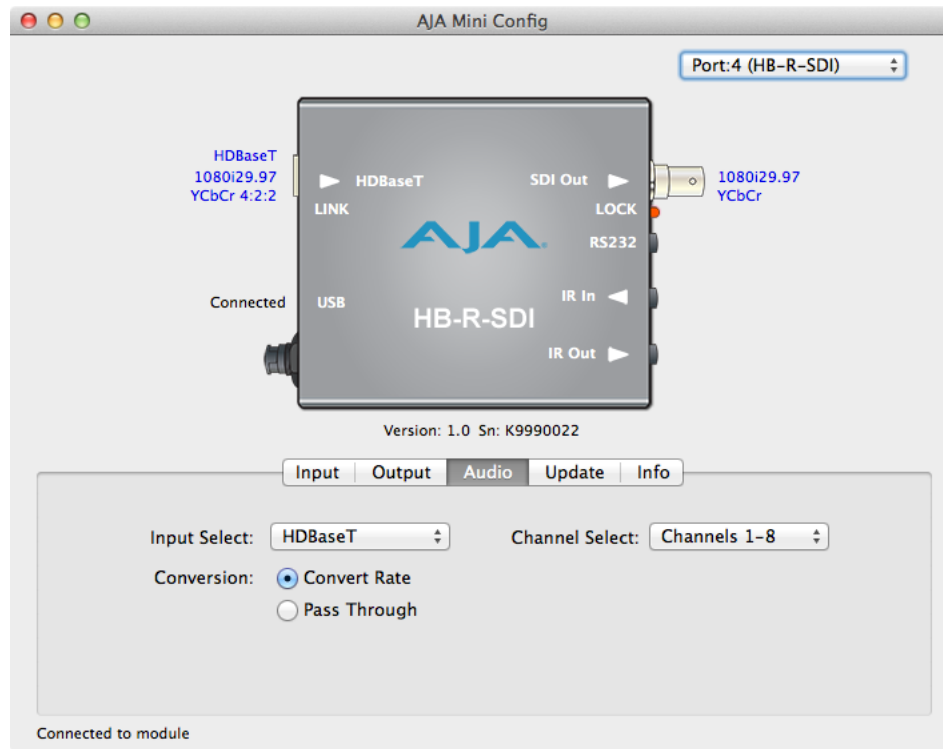

Input Select

Chooses what audio channels are routed to the SDI output.

- HDBaseT (default)
- None - No audio will be embedded. All channels are muted.

Conversion

Choose the audio conversion to be performed on the incoming audio.

- Convert Rate - The audio will be converted, if necessary, to 24-bit/48 KHz audio.
- Pass Through - The audio will be passed to the SDI embedded audio channels without conversion.

Channel Select

Choose which set of 8 channels (4 pairs) of embedded audio the SDI output will carry.

- Channels 1-8 (default)
- Channels 9-16.

Update Tab Screen

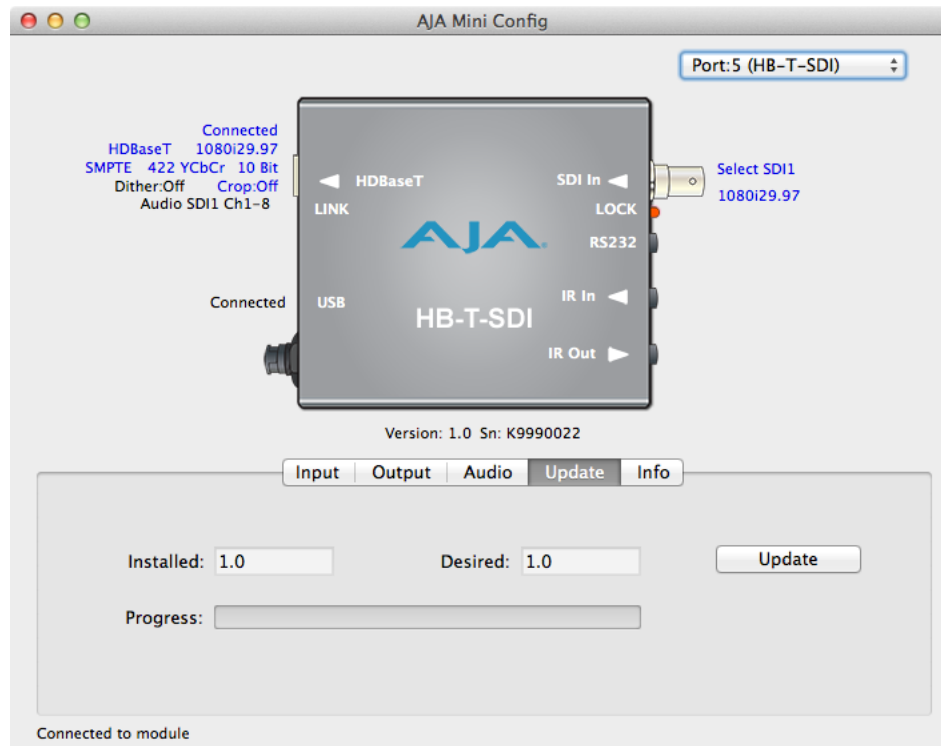

Use this Update tab screen to view the software version currently installed on the converter or install new software.

NOTE: When discussing Mini-Converters, “Firmware” is software that will be stored in the Mini-Converter’s non-volatile memory and used when it is powered up. This is something different than the Mini-Config application software. The version numbers shown in the Update screen refer only to the firmware.

Installed

This field shows the version of the firmware currently installed inside the Mini-Converter.

Desired

This field shows the version of firmware embedded in the Mini-Config application which you can install into the Mini-Converter by clicking the Update button.

Update

This button initiates a software update operation loading the “Desired” version of firmware into the Mini-Converter’s non-volatile memory.

Progress

This indicator bar shows the progress of firmware installation.

See ["Acquiring Mini-Config" on page 8](#) and ["Installing Mini-Config" on page 8](#) for more information.

Info Tab Screen

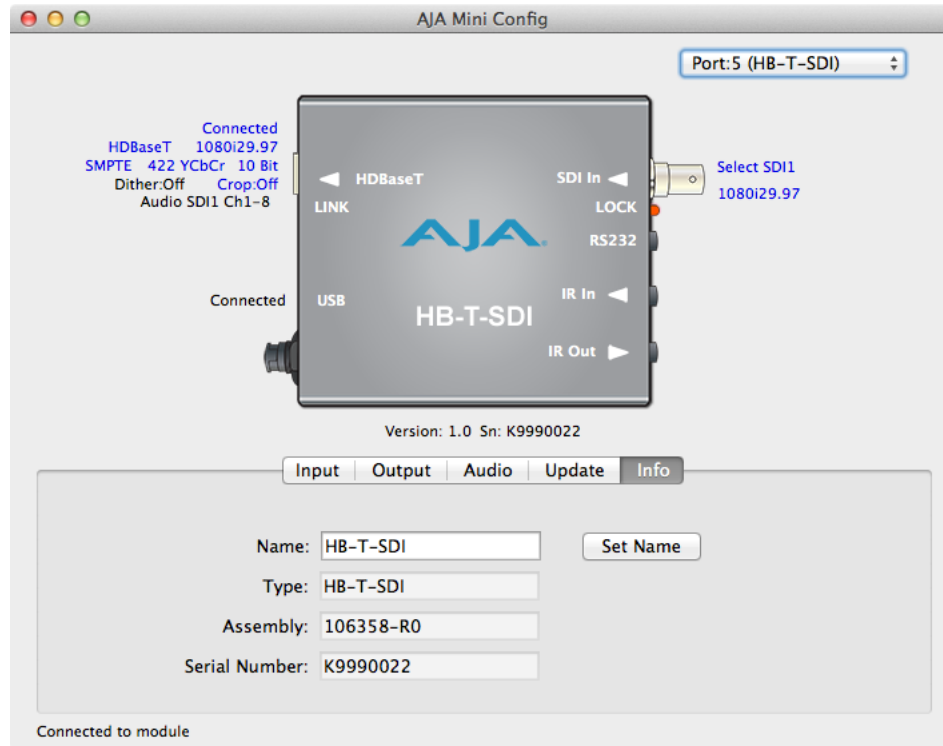

This screen provides basic information about the Mini-Converter. This information is mostly useful when calling AJA Support for service or technical support.

Name

This field allows you to give your Mini-Converter a name. This can be useful if you have several Mini-Converters attached to a Mac/PC via USB so you can distinguish between them easily (especially if they're the same model).

Type

This is the factory set model name of the Mini-Converter.

Assembly

This is the factory assembly number.

Serial Number

This is the factory set unique serial number of your Mini-Converter. If you ever call AJA Support for service, you may be asked for this number.

Appendix A – Specifications

HB-T-SDI Tech Specs

Video Formats

- (2K) 2048 x 1080p 23.98, 24, 25, 29.97, 30, 50, 59.94, 60
- (HD) 1080p 23.98, 24, 25, 29.97, 50, 59.94, 60
- (HD) 1920 x 1080i 50, 59.94, 60
- (HD) 720p 25, 29.97, 50, 59.94, 60
- (SD) 625i
- (SD) 525i

NOTE: PsF formats are converted to progressive outputs over the HDBaseT link

Video Input

- 3G-SDI

Video Output

- HDBaseT (RJ-45)
- Cat 5e 70m (230 ft) or Cat 6a 100m (328 ft)
- 4K/UltraHD signals require Cat 6a to achieve 100m cable run (HD signals can run the full 100m on Category 5e Cable)

Video Displays

- HDBaseT Cable Run Performance for 4K/UltraHD/HD

Table 2. HDBaseT Cable Run Performance for 4K/UltraHD/HD

W x H	Frame Rate	Color Sampling	Max. Cable Length		Max. Bit Depth
			Cat 5e/6	Cat 6a/7	
1920x1080	< 30 fps	4:2:2	100 meters	100 meters	16-bit
		4:2:2	100 meters	100 meters	12-bit
	>30 fps	4:2:2	70 meters	100 meters	16-bit
2048x1080	< 30 fps	4:2:2	100 meters	100 meters	16-bit
		4:2:2	100 meters	100 meters	12-bit
	>30 fps	4:2:2	70 meters	100 meters	16-bit
3840x2160	< 30 fps	4:4:4	70 meters	100 meters	8-bit
	> 30 fps	4:2:0	70 meters	100 meters	8-bit
4096x2160	< 30 fps	4:4:4	70 meters	100 meters	8-bit
	> 30 fps	4:2:0	70 meters	100 meters	8-bit

Audio Input

- 8-Channels (4 pairs) of SDI embedded audio supported, select from 16-Channels (8 pairs)

Audio Output

- HDBaseT embedded audio

RS-232

- 1x 3.5mm TRS Input for RS-232/VISCA bidirectional signals

IR

- 1x 3.5mm TRS Input for IR Input
- 1x 3.5mm TRS Input for IR Output

Size (w x d x h)

- 4.0" x 4.6" x 1.0" (101.6 x 116.84 x 25.4 mm)

Weight

- 0.6 lbs (0.3 kg)

Power

- +5 to 20V DC regulated, 9 watts max., AJA external power supply model DWP-U-R1, 100-240V, 50/60 Hz universal input

Environment

- Safe Operating Temperature: 0 to 40 C (32 to 104 F)
- Safe Storage Temperature (Power OFF): -40 to 60 C (-40 to 140 F)
- Operating Relative Humidity: 10-90% noncondensing
- Operating Altitude: <3,000 meters (<10,000 feet)

HB-R-SDI Tech Specs

Video Formats

- (2K) 2048 x 1080p 23.98, 24, 25, 29.97, 30, 50, 59.94, 60
- (HD) 1080p 23.98, 24, 25, 29.97, 50, 59.94, 60
- (HD) 1920 x 1080i 50, 59.94, 60
- (HD) 720p 25, 29.97, 50, 59.94, 60
- (SD) 625i
- (SD) 525i

NOTE: PsF formats are converted to progressive outputs over the HDBaseT link

Video Input

- HDBaseT (RJ-45)

Video Output

- 3G-SDI

Video Displays

- HDBaseT Cable Run Performance for 4K/UltraHD/HD

Table 3. HDBaseT Cable Run Performance for 4K/UltraHD/HD

W x H	Frame Rate	Color Sampling	Max. Cable Length		Max. Bit Depth
			Cat 5e/6	Cat 6a/7	
1920x1080	< 30 fps	4:2:2	100 meters	100 meters	16-bit
	>30 fps	4:2:2	100 meters	100 meters	12-bit
		4:2:2	70 meters	100 meters	16-bit
2048x1080	< 30 fps	4:2:2	100 meters	100 meters	16-bit
	>30 fps	4:2:2	100 meters	100 meters	12-bit
		4:2:2	70 meters	100 meters	16-bit
3840x2160	< 30 fps	4:4:4	70 meters	100 meters	8-bit
	> 30 fps	4:2:0	70 meters	100 meters	8-bit
4096x2160	< 30 fps	4:4:4	70 meters	100 meters	8-bit
	> 30 fps	4:2:0	70 meters	100 meters	8-bit

Audio Output

- 3G-SDI Embedded Audio
- 8-Channels (4 pairs) of SDI embedded audio supported, select from 16-channels (8 pairs)

RS-232

- 1x 3.5mm TRS Input for RS-232/VISCA Bidirectional signals

IR

- 1x 3.5mm TRS Input for IR Input
- 1x 3.5mm TRS Input for IR Output

Size (w x d x h)

- 4.0" x 4.6" x 1.0" (101.6 x 116.84 x 25.4 mm)

Weight

- 0.6 lbs (0.3 kg)

Power

- +5 to 20V DC regulated, 9 watts max., AJA external power supply model DWP-U-R1, 100-240V, 50/60 Hz universal input

Environment

- Safe Operating Temperature: 0 to 40 C (32 to 104 F)
- Safe Storage Temperature (Power OFF): -40 to 60 C (-40 to 140 F)
- Operating Relative Humidity: 10-90% noncondensing
- Operating Altitude: <3,000 meters (<10,000 feet)

Appendix B – Safety and Compliance

Federal Communications Commission (FCC) Compliance Notices

Class A Interference Statement

This equipment has been tested and found to comply with the limits for a Class A digital device, pursuant to Part 15, Subpart B of the FCC Rules. These limits are designed to provide reasonable protection against harmful interference in a residential installation. This equipment generates, uses, and can radiate radio frequency energy and, if not installed and used in accordance with the instructions, may cause harmful interference to radio communications. However, there is no guarantee that interference will not occur in a particular installation. If this equipment does cause harmful interference to radio or television reception, which can be determined by turning the equipment off and on, the user is encouraged to try to correct the interference by one or more of the following measures:

- Reorient or relocate the receiving antenna.
- Increase the separation between the equipment and receiver.
- Connect the equipment into an outlet on a circuit different from that to which the receiver is connected.
- Consult the dealer or an experienced radio/TV technician for help.

FCC Caution

This device complies with Part 15 of the FCC Rules. Operation is subject to the following two conditions: (1) This device may not cause harmful interference, and (2) this device must accept any interference received, including interference that may cause undesired operation.

Canadian ICES Statement

Canadian Department of Communications Radio Interference Regulations

This digital apparatus does not exceed the Class A limits for radio-noise emissions from a digital apparatus as set out in the Radio Interference Regulations of the Canadian Department of Communications. This Class A digital apparatus complies with Canadian ICES-003.

Règlement sur le brouillage radioélectrique du ministère des Communications

Cet appareil numérique respecte les limites de bruits radioélectriques visant les appareils numériques de classe A prescrites dans le Règlement sur le brouillage radioélectrique du ministère des Communications du Canada. Cet appareil numérique de la Classe A est conforme à la norme NMB-003 du Canada.

European Union and European Free Trade Association (EFTA) Regulatory Compliance

This equipment may be operated in the countries that comprise the member countries of the European Union and the European Free Trade Association. These countries, listed in the following paragraph, are referred to as The European Community throughout this document:

AUSTRIA, BELGIUM, BULGARIA, CYPRUS, CZECH REPUBLIC, DENMARK, ESTONIA, FINLAND, FRANCE, GERMANY, GREECE, HUNGARY, IRELAND, ITALY, LATVIA, LITHUANIA, LUXEMBOURG, MALTA, NETHERLANDS, POLAND, PORTUGAL, ROMANIA, SLOVAKIA, SLOVENIA, SPAIN, SWEDEN, UNITED KINGDOM, ICELAND, LICHTENSTEIN, NORWAY, SWITZERLAND

Declaration of Conformity

Marking by this symbol indicates compliance with the Essential Requirements of the EMC Directive of the European Union 2014/30/EU.



This equipment meets the following conformance standards:

Safety

EN 60065: 2014 (T-Mark License)

IEC 60065: 2014 (CB Scheme Report/Certificate)

Additional licenses issued for specific countries available on request.

Emissions

EN 55032: 2012, CISPR 32: 2015,

EN 61000-3-2: 2014, EN 61000-3-3: 2013

Immunity

EN 55103-2: 2009

EN 61000-4-2:2009, EN 61000-4-3:2006 +A1:2008 +A2:2010,

EN 61000-4-4:2004 +A1:2010, EN 61000-4-5:2006, EN 61000-4-6: 2009

EN 61000-4-11:2004

Environments: E2, E3 and E4

The product is also licensed for additional country specific standards as required for the International Marketplace.



Warning! This is a Class A product. In a domestic environment, this product may cause radio interference, in which case, the user may be required to take appropriate measures.

Achtung! Dieses ist ein Gerät der Funkstörgrenzwertklasse A. In Wohnbereichen können bei Betrieb dieses Gerätes Rundfunkstörungen auftreten, in welchen Fällen der Benutzer für entsprechende Gegenmaßnahmen verantwortlich ist.

Attention! Ceci est un produit de Classe A. Dans un environnement domestique, ce produit risque de créer des interférences radioélectriques, il appartiendra alors à l'utilisateur de prendre les mesures spécifiques appropriées..

Recycling Notice



This symbol on the product or its packaging indicates that this product must not be disposed of with your other household waste. Instead, it is your responsibility to dispose of your waste equipment by handing it over to a designated collection point for the recycling of waste electrical and electronic equipment. The separate collection and recycling of your waste equipment at the time of disposal will help conserve natural resources and ensure that it is recycled in a manner that protects human health and the environment. For more information about where you can drop off your waste for recycling, please contact your local authority, or where you purchased your product.

Korea KCC Compliance Statement

<p>A급 기기 (업무용 방송통신기자재)</p>	<p>이 기기는 업무용(A급) 전자파적합기기로서 판매자 또는 사용자는 이 점을 주의하시기 바라며, 가정외의 지역에서 사용하는 것을 목적으로 합니다.</p>
<p>Class A (Broadcasting Communication Equipment for Office Use)</p>	<p>As an electromagnetic wave equipment for office use (Class A), this equipment is intended to use in other than home area. Sellers or users need to take note of this.</p>

Taiwan Compliance Statement

警告使用者：
這是甲類的資訊產品，在居住的環境中使用時，可能會造成射頻干擾，在這種情況下，使用者會被要求採取某些適當的對策。

This is a Class A product based on the standard of the Bureau of Standards, Metrology and Inspection (BSMI) CNS 13438, Class A. In a domestic environment this product may cause radio interference in which case the user may be required to take adequate measures.

Japan Compliance Statement

この装置は、クラスA情報技術装置です。この装置を家庭環境で使用すると電波妨害を引き起こすことがあります。この場合には使用者が適切な対策を講ずるよう要求されることがあります。 VCCI-A

This is a Class A product based on the standard of the VCCI Council (VCCI 32: 2016). If this equipment is used in a domestic environment, radio interference may occur, in which case, the user may be required to take corrective actions.

Translated Warning and Caution Messages

The following caution statements, warning conventions, and warning messages apply to this product and manual.



Warning Symbol



Caution Symbol

Before Operation Please Read These Instructions



Warning! Read and follow all warning notices and instructions marked on the product or included in the documentation.

Avertissement! Lisez et conformez-vous à tous les avis et instructions d'avertissement indiqués sur le produit ou dans la documentation.

Warnung! Lesen und befolgen Sie die Warnhinweise und Anweisungen, die auf dem Produkt angebracht oder in der Dokumentation enthalten sind.

¡Advertencia! Lea y siga todas las instrucciones y advertencias marcadas en el producto o incluidas en la documentación.

Aviso! Leia e siga todos os avisos e instruções assinalados no produto ou incluídos na documentação.

Avviso! Leggere e seguire tutti gli avvisi e le istruzioni presenti sul prodotto o inclusi nella documentazione.



Warning! Do not use this device near water and clean only with a dry cloth.

Avertissement! N'utilisez pas cet appareil près de l'eau et nettoyez-le seulement avec un tissu sec.

Warnung! Das Gerät nicht in der Nähe von Wasser verwenden und nur mit einem trockenen Tuch säubern.

¡Advertencia! No utilice este dispositivo cerca del agua y límpielo solamente con un paño seco.

Aviso! Não utilize este dispositivo perto da água e limpe-o somente com um pano seco.

Avviso! Non utilizzare questo dispositivo vicino all'acqua e pulirlo soltanto con un panno asciutto.



Warning! Do not block any ventilation openings. Install in accordance with the manufacturer's instructions.

Avertissement! Ne bloquez aucune ouverture de ventilation. Suivez les instructions du fabricant lors de l'installation.

Warnung! Die Lüftungsöffnungen dürfen nicht blockiert werden. Nur gemäß den Anweisungen des Herstellers installieren.

¡Advertencia! No bloquee ninguna de las aberturas de la ventilación. Instale de acuerdo con las instrucciones del fabricante.

Aviso! Não obstrua nenhuma das aberturas de ventilação. Instale de acordo com as instruções do fabricante.

Avviso! Non ostruire le aperture di ventilazione. Installare in conformità con le istruzioni del fornitore.



Warning! Do not install near any heat sources such as radiators, heat registers, stoves, or other apparatus (including amplifiers) that produce heat.

Avertissement! N'installez pas l'appareil près d'une source de chaleur telle que des radiateurs, des bouches d'air de chauffage, des fourneaux ou d'autres appareils (amplificateurs compris) qui produisent de la chaleur.

Warnung! Nicht in der Nähe von Wärmequellen wie Heizkörpern, Heizregistern, Öfen oder anderen Wärme erzeugenden Geräten (einschließlich Verstärkern) aufstellen.

¡Advertencia! No instale cerca de fuentes de calor tales como radiadores, registros de calor, estufas u otros aparatos (incluidos amplificadores) que generan calor.

Aviso! Não instale perto de nenhuma fonte de calor tal como radiadores, saídas de calor, fogões ou outros aparelhos (incluindo amplificadores) que produzam calor.

Avviso! Non installare vicino a fonti di calore come termosifoni, diffusori di aria calda, stufe o altri apparecchi (amplificatori compresi) che emettono calore



Warning! Do not defeat the safety purpose of the polarized or grounding-type plug. A polarized plug has two blades with one wider than the other. A grounding type plug has two blades and a third grounding prong. The wide blade or the third prong are provided for your safety. If the provided plug does not fit into your outlet, consult an electrician for replacement of the obsolete outlet.

Avertissement! La sécurité de la prise polarisée ou de la prise de type mise à la terre ne doit en aucun cas être empêchée de fonctionner. Une prise polarisée a deux broches, l'une étant plus large que l'autre. Une prise de type mise à la terre a deux broches et une troisième broche pour la mise à la terre. La broche large ou la troisième broche sont fournies pour votre sécurité. Si la prise fournie ne s'insère pas dans votre prise femelle, consultez un électricien pour le remplacement de la prise femelle obsolète.

Warnung! Der Sicherheitszweck des gepolten bzw. Schukosteckers ist zu berücksichtigen. Ein gepolter Stecker verfügt über zwei Pole, von denen einer breiter als der andere ist. Ein Schukostecker verfügt neben den zwei Polen noch über einen dritten Pol zur Erdung. Der breite Pol bzw. der Erdungspol dienen der Sicherheit. Wenn der zur Verfügung gestellte Stecker nicht in Ihren Anschluss passt, konsultieren Sie einen Elektriker, um den veralteten Anschluss zu ersetzen.

¡Advertencia! No eche por tierra la finalidad del tipo de enchufe polarizado con conexión a tierra. Un enchufe polarizado tiene dos espigas, una más ancha que la otra. Un enchufe con conexión a tierra tiene dos espigas iguales y una tercera espiga que sirve para la conexión a tierra. La espiga ancha, o la tercera espiga, sirven para su seguridad. Si el enchufe suministrado no encaja en el tomacorriente, consulte con un electricista para reemplazar el tomacorriente obsoleto.

Aviso! Não anule a finalidade da segurança da ficha polarizada ou do tipo ligação terra. Uma ficha polarizada tem duas lâminas sendo uma mais larga do que a outra. Uma ficha do tipo de ligação à terra tem duas lâminas e um terceiro terminal de ligação à terra. A lâmina larga ou o terceiro terminal são fornecidos para sua segurança. Se a ficha fornecida não couber na sua tomada, consulte um electricista para a substituição da tomada obsoleta.

Avviso! Non compromettere la sicurezza della spina polarizzata o con messa a terra. Una spina polarizzata ha due spinotti, di cui uno più largo. Una spina con messa a terra ha due spinotti e un terzo polo per la messa a terra. Lo spinotto largo o il terzo polo sono forniti per motivi di sicurezza. Se la spina fornita non si inserisce nella presa di corrente, contattare un elettricista per la sostituzione della presa obsoleta.



Warning! Since the Mains plug is used as the disconnection for the device, it must remain readily accessible and operable.

Avertissement! Puisque la prise principale est utilisée pour débrancher l'appareil, elle doit rester aisément accessible et fonctionnelle.

Warnung! Da der Netzstecker als Trennvorrichtung dient, muss er stets zugänglich und funktionsfähig sein.

¡Advertencia! Puesto que el enchufe de la red eléctrica se utiliza como dispositivo de desconexión, debe seguir siendo fácilmente accesible y operable.

Aviso! Dado que a ficha principal é utilizada como a desconexão para o dispositivo, esta deve manter-se prontamente acessível e funcional.

Avviso! Poiché il cavo di alimentazione viene usato come dispositivo di sconnessione, deve rimanere prontamente accessibile e operabile.



Warning! Protect the power cord from being walked on or pinched particularly at plugs, convenience receptacles, and the point where they exit from the device.

Avertissement! Protégez le cordon d'alimentation pour que l'on ne marche pas dessus ou qu'on le pince, en particulier au niveau des prises mâles, des réceptacles de convenance, et à l'endroit où il sort de l'appareil.

Warnung! Vermeiden Sie, dass auf das Netzkabel getreten oder das Kabel geknickt wird, insbesondere an den Steckern, den Steckdosen und am Kabelaustang am Gerät.

¡Advertencia! Proteja el cable de energía para que no se le pise ni apriete, en especial cerca del enchufe, los receptáculos de conveniencia y el punto del que salen del equipo.

Aviso! Proteja o cabo de alimentação de ser pisado ou de ser comprimido particularmente nas fichas, em tomadas de parede de conveniência e no ponto de onde sai do dispositivo.

Avviso! Proteggere il cavo di alimentazione in modo che nessuno ci cammini sopra e che non venga schiacciato soprattutto in corrispondenza delle spine e del punto in cui esce dal dispositivo.



Warning! Unplug this device during lightning storms or when unused for long periods of time.

Avertissement! Débranchez cet appareil pendant les orages avec éclairsou s'il est inutilisé pendant de longues périodes.

Warnung! Das Gerät ist bei Gewitterstürmen oder wenn es über lange Zeiträume ungenutzt bleibt vom Netz zu trennen.

¡Advertencia! Desenchufe este dispositivo durante tormentas eléctricas o cuando no se lo utilice por largos periodos del tiempo.

Aviso! Desconecte este dispositivo da tomada durante trovoadas ou quando não é utilizado durante longos períodos de tempo.

Avviso! Utilizzare soltanto i collegamenti e gli accessori specificati e/o venduti dal produttore, quali il treppiedi e l'esoscheletro.



Warning! Refer all servicing to qualified service personnel. Servicing is required when the device has been damaged in any way, such as power-supply cord or plug is damaged, liquid has been spilled or objects have fallen into the device, the device has been exposed to rain or moisture, does not operate normally, or has been dropped.

Avertissement! Référez-vous au personnel de service qualifié pour tout entretien. L'entretien est exigé quand l'appareil a été endommagé de quelque manière que ce soit, par exemple lorsque le cordon d'alimentation ou la prise sont endommagés, que du liquide a été versé ou des objets sont tombés dans l'appareil, que l'appareil a été exposé à la pluie ou à l'humidité, ne fonctionne pas normalement ou est tombé.

Warnung! Das Gerät sollte nur von qualifizierten Fachkräften gewartet werden. Eine Wartung ist fällig, wenn das Gerät in irgendeiner Weise beschädigt wurde, wie bei beschädigtem Netzkabel oder Netzstecker, falls Flüssigkeiten oder Objekte in das Gerät gelangen, das Gerät Regen oder Feuchtigkeit ausgesetzt wurde, nicht ordnungsgemäß funktioniert oder fallen gelassen wurde.

¡Advertencia! Consulte al personal calificado por cuestiones de reparación. El servicio de reparación se requiere cuando el dispositivo ha recibido cualquier tipo de daño, por ejemplo cable o espigas dañadas, se ha derramado líquido o se han caído objetos dentro del dispositivo, el dispositivo ha sido expuesto a la lluvia o humedad, o no funciona de modo normal, o se ha caído.

Aviso! Remeta todos os serviços de manutenção para o pessoal de assistência qualificado. A prestação de serviços de manutenção é exigida quando o dispositivo foi danificado mediante qualquer forma, como um cabo de alimentação ou ficha que se encontra danificado/a, quando foi derramado líquido ou caíram objectos sobre o dispositivo, quando o dispositivo foi exposto à chuva ou à humidade, quando não funciona normalmente ou quando foi deixado cair.

Avviso! Fare riferimento al personale qualificato per tutti gli interventi di assistenza. L'assistenza è necessaria quando il dispositivo è stato danneggiato in qualche modo, ad esempio se il cavo di alimentazione o la spina sono danneggiati, è stato rovesciato del liquido è stato rovesciato o qualche oggetto è caduto nel dispositivo, il dispositivo è stato esposto a pioggia o umidità, non funziona correttamente o è caduto



Warning! Do not open the chassis. There are no user-serviceable parts inside. Opening the chassis will void the warranty unless performed by an AJA service center or licensed facility.

Avertissement! Ne pas ouvrir le châssis. Aucun élément à l'intérieur du châssis ne peut être réparé par l'utilisateur. La garantie sera annulée si le châssis est ouvert par toute autre personne qu'un technicien d'un centre de service ou d'un établissement agréé AJA.

Warnung! Öffnen Sie das Gehäuse nicht. Keine der Geräteteile können vom Benutzer gewartet werden. Durch das Öffnen des Gehäuses wird die Garantie hinfällig, es sei denn, solche Wartungsarbeiten werden in einem AJA-Service-Center oder einem lizenzierten Betrieb vorgenommen.

¡Advertencia! No abra el chasis. El interior no contiene piezas reparables por el usuario. El abrir el chasis anulará la garantía a menos que se lo haga en un centro de servicio AJA o en un local autorizado.

Advertência! Não abra o chassi. Não há internamente nenhuma peça que permita manutenção pelo usuário. Abrir o chassi anula a garantia, a menos que a abertura seja realizada por uma central de serviços da AJA ou por um local autorizado.

Avvertenza! Non aprire lo chassis. All'interno non ci sono parti riparabili dall'utente. L'apertura dello chassis invaliderà la garanzia se non viene effettuata da un centro ufficiale o autorizzato AJA.



Warning! Disconnect the external AC power supply line cord(s) from the mains power before moving the unit.

Avertissement! Retirez le ou les cordons d'alimentation en CA de la source d'alimentation principale lorsque vous déplacez l'appareil.

Warnung! Trennen Sie die Wechselstrom-Versorgungskabel vom Netzstrom, bevor Sie das Gerät verschieben.

¡Advertencia! Cuando mueva la unidad desenchufe de la red eléctrica el/los cable(s) de la fuente de alimentación CA tipo brick.

Advertência! Remova os cabos CA de alimentação brick da rede elétrica ao mover a unidade.

Avvertenza! Scollegare il cavo dell'alimentatore quando si sposta l'unità.



Warning! Only use attachments and accessories specified and/or sold by the manufacturer.

Avertissement! Utilisez seulement les attaches et accessoires spécifiés et/ou vendus par le fabricant.

Warnung! Verwenden Sie nur Zusatzgeräte und Zubehör angegeben und / oder verkauft wurde durch den Hersteller.

¡Advertencia! Utilice solamente los accesorios y conexiones especificados y/o vendidos por el fabricante.

Aviso! Utilize apenas equipamentos/acessórios especificados e/ou vendidos pelo fabricante.

Avviso! Utilizzare soltanto i collegamenti e gli accessori specificati e/o venduti dal produttore.

Warranty and Liability Information

AJA VIDEO SYSTEMS, INC.

Limited Warranty on Hardware

AJA Video Systems, Inc. (AJA Video) warrants that the hardware product, not including storage modules or software components, will be free from defects in materials and workmanship for a period of five (5) years from the date of purchase. AJA Video warrants that the storage modules provided as part of the hardware product will be free from defects in materials and workmanship for a period of one year from the date of purchase. AJA Video provides a separate software warranty as part of the license agreement applicable to software components.

If a hardware product or storage module (hereafter, a “product”) proves to be defective during the applicable warranty period, AJA Video, at its option, will either repair the defective product without charge for parts and labor, or will provide a replacement in exchange for the defective product.

To obtain service under this warranty, the Customer must notify AJA Video of the defect before expiration of the warranty period and make suitable arrangements for the performance of service by contacting AJA Video support through the channels set forth on the support contacts web page at <http://www.aja.com/support>. Except as stated, the Customer shall bear all shipping, packing, insurance and other costs, excluding parts and labor, to effectuate repair. Customer shall pack and ship the defective product to a service center designated by AJA Video, with shipping charges prepaid. AJA Video shall pay to return the product to Customer but only if to a location within the country in which the AJA Video service center is located.

This warranty shall not apply to any defect, failure or damage caused by negligent, inadequate or improper use, handling or maintenance. Without limiting the foregoing, AJA Video shall not be obligated to furnish service under this warranty or repair any damage or malfunction a) resulting from attempts by personnel other than AJA Video representatives to install, repair or service the product, b) resulting from improper use or connection to incompatible equipment, c) caused by the use of non-AJA Video parts or supplies, d) if the product has been modified or integrated with other products when the effect of such a modification or integration increases the time or difficulty of servicing the product, or e) resulting from being dropped or otherwise subjected to undue force, exposure to moisture or other corrosive or conductive substances, exposure to strong magnetic fields, use with improperly regulated power supplies, exposure to electric shock, use in temperatures outside the specified operating range, or otherwise failing to treat the product in accordance with the standard of care appropriate to sensitive and delicate electronic equipment.

EXCEPT AS STATED ABOVE, AJA VIDEO AND ITS VENDORS DISCLAIM IN THEIR ENTIRETY ALL OTHER WARRANTIES, EXPRESS OR IMPLIED, INCLUDING WITHOUT LIMITATION ALL WARRANTIES OF MERCHANTABILITY OR FITNESS FOR A PARTICULAR PURPOSE. AJA VIDEO'S RESPONSIBILITY TO REPAIR OR REPLACE TIMELY REPORTED DEFECTIVE PRODUCTS IS THE WHOLE AND EXCLUSIVE REMEDY CUSTOMER IS PROVIDED WITH RESPECT TO HARDWARE PRODUCTS AND THEIR STORAGE MODULES. SOME JURISDICTIONS DO NOT ALLOW THE EXCLUSION OF IMPLIED WARRANTIES OR LIMITATIONS ON APPLICABLE STATUTORY RIGHTS OF A CONSUMER, SO SOME OR ALL OF THE TERMS OF THIS PARAGRAPH MAY NOT APPLY TO YOU.

THE PRODUCT IS NOT INTENDED, STATED, OR WARRANTED TO OPERATE UNINTERRUPTED OR ERROR-FREE. YOU UNDERSTAND AND ACKNOWLEDGE THAT THE PRODUCT IS NOT INTENDED TO BE USED AS THE SOLE OR PRIMARY DATA SOURCE OR TARGET FOR CRITICAL DATA, AND THAT IT IS YOUR RESPONSIBILITY TO IMPLEMENT REDUNDANT CAPTURE AND BACKUP SYSTEMS AS APPROPRIATE.

Limitation of Liability

Under no circumstances shall AJA video BE LIABLE IN ANY WAY FOR ANY LOST, CORRUPTED OR DESTROYED DATA, FOOTAGE OR WORK, OR FOR ANY OTHER INDIRECT, SPECIAL, INCIDENTAL OR CONSEQUENTIAL DAMAGES OR LOST PROFITS, OR FOR ANY THIRD PARTY CLAIM, IN CONNECTION WITH THE PRODUCT, WHETHER RESULTING FROM DEFECTS IN THE PRODUCT, SOFTWARE OR HARDWARE FAILURE, OR ANY OTHER CAUSE WHATSOEVER, EVEN IF AJA VIDEO HAS BEEN ADVISED OF THE POSSIBILITY OF SUCH DAMAGES. AJA VIDEO'S LIABILITY IN CONNECTION WITH THE PRODUCT SHALL UNDER NO CIRCUMSTANCES EXCEED THE PURCHASE PRICE PAID FOR THE PRODUCT. The foregoing limitations apply even if any remedy set forth in this LIMITED WARRANTY fails of its essential purpose. SOME JURISDICTIONS DO NOT ALLOW THE LIMITATION OF LIABILITY FOR PERSONAL INJURY, OR OF INCIDENTAL OR CONSEQUENTIAL DAMAGES, SO SOME OR ALL OF THE TERMS OF THIS PARAGRAPH MAY NOT APPLY TO YOU.

Governing Law and Language; Your Rights.

This limited warranty is the only warranty provided by AJA Video on the hardware product. It supersedes all prior or contemporaneous understandings regarding such subject matter. No amendment to or modification of this warranty will be binding unless in writing and signed by AJA Video. The laws of the State of California, USA will govern this warranty and any dispute arising from it. Any translation of this Agreement is intended for convenience and to meet local requirements and in the event of a dispute between the English and any non-English versions, the English version of this warranty will govern. This limited warranty gives you specific legal rights and you may have other rights that vary from jurisdiction to jurisdiction, some of which are noted above.

Index

Symbols

- 2K Crop 16
- 3G-B Mode 14
- 3G Mode 16

A

- AJA Support 2
- Audio Offset In Frames 17

B

- Bit Depth 14, 15
- Block Diagrams 5
- Breakout Cable Pinouts 8

C

- CAT Cable Types 7
- Channel Select 18
- Color Dithering 16
- Color Space 13, 15
- Conversion 18

D

- Default Operational Settings 8
- Documentation
 - Downloading 8
 - Mini-Converter 8

E

- Enable PtoPsF 17

F

- Features 4

H

- HB-R-SDI Audio Tab Screen 18
- HB-R-SDI Input Tab Screen 14
- HB-R-SDI Output Tab Screen 16
- HB-T-SDI Audio Tab Screen 17
- HB-T-SDI Input Tab Screen 13
- HB-T-SDI Output Tab Screen 15

I

- Info Tab Screen 20
- Input Select 18
- Input Source 17
- Installation 6
- I/O Connections 5

M

- Mini-Config
 - Installation on Mac 9
 - Installation on PC 8
 - Operation 11
 - Screen Description 12
 - Startup on Mac 10

- Startup on PC 10
- Mini-Config Screen
 - Info Tab Screen 20
 - Update Tab Screen 19
- Mini-Converter Documentation 8

O

- Output Channel Count 17
- Overview 4

P

- Pairing SDI and HDMI HDBaseT Converters 7

R

- RGB Range 13, 15, 16

S

- Saving Setups 10

T

- Technical Support 2

U

- Update Tab Screen 19

V

- Video Format 14