

D•TWO

MULTITAP RHYTHM DELAY



USER'S MANUAL

TABLE OF CONTENTS

INTRODUCTION

<i>Table of Contents</i>	3
<i>Introduction</i>	5
<i>Front Panel</i>	6
<i>Rear Panel</i>	8
<i>Signal Flow Diagram</i>	9
<i>D•TWO Setup</i>	10

BASIC OPERATION

<i>The D•TWO Display</i>	11
<i>Setup</i>	13
<i>Recall</i>	15
<i>Edit</i>	15
<i>Store</i>	15

ALGORITHMS

Delay Modes

<i>Traditional Delay Mode</i>	16
<i>Straight Delay Mode</i>	17
<i>Rhythm Mode</i>	19
<i>Rhythm Tap Edit</i>	20
<i>PingPong</i>	21
<i>Dynamic</i>	22
<i>Reverse</i>	22
<i>Shortcuts</i>	23

Additional Algorithms

<i>Spatial</i>	24
<i>Filter</i>	24
<i>Chorus</i>	24

APPENDIX

<i>Important Safety Instructions</i>	26
<i>MIDI Implementation</i>	28
<i>Technical Specifications</i>	29
<i>Preset List</i>	30

INTRODUCTION

Congratulations on the purchase of your new D•TWO Multi-tap Rhythm Delay.

The D•TWO Multi-tap Rhythm Delay is an easy to use, high quality digital Delay unit. When it comes to Delay effects we are convinced that with this unit you are well covered. This applies for live-sound production as well as in the studio. The D•TWO covers not only all the traditional Delay functions, but also a few brand new ones. With traditional Delay units it is generally only possible to control Feedback and Level on a specified fixed Delay time. With the D•TWO you are now able to tap actual rhythm patterns consisting of up to 10 taps directly into the unit. Many will recognize the TC 2290 studio Delay unit as the Delay unit that introduced the "Dynamic Delay" function. A function that allows the Delay Output level to be actively altered by the dynamics of the Input level. A function that can be used to leave the source material clear and undisturbed while played and delicately accompanied by the Delay between phrases. Yes, this feature is also available in the D•TWO. We hope you will have as much pleasure using the D•TWO as we had making it.

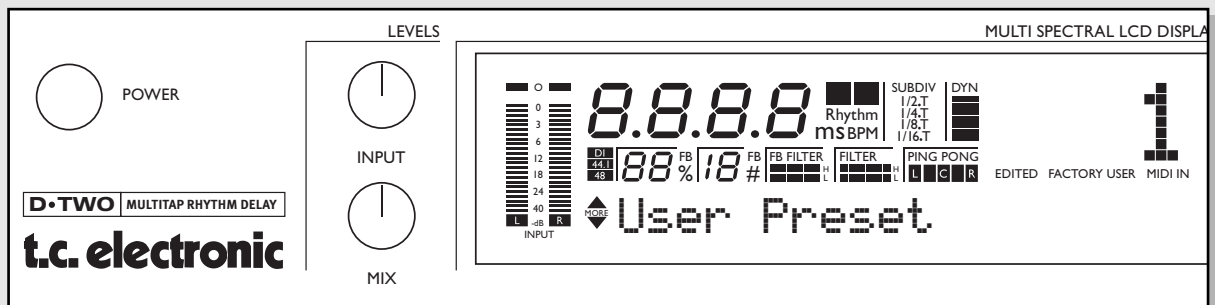

FRONT PANEL

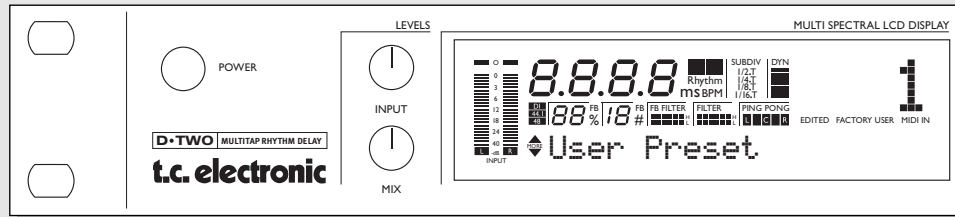

POWER button

Power on/off.

IN LEVEL knob

Adjusts the Input level. At center position a relay will switch the Input circuit between consumer and pro level. This will insure optimal Input gain range and superb "signal to noise" ratio is achieved.

MIX knob

Adjusts the global mix between dry and wet signal. Fully clockwise position is 100% effect.

IN meters

The IN Peak meter shows the Input level of left and right channels. The meter range is: 0, -3, -6, -12, -18, -24, -40dB.

OVERLOAD LEDS

The OVERLOAD LEDs indicate one of two situations:

- The Input level is too hot and therefore overloading.
- There is an internal DSP overflow.

The Overload LED is lit when 1 sample is @ 0dBFS.

DELAY TIME indicator

The DELAY TIME indicator can display Delay time in either ms (milliseconds) or BPM (Beats Per Minute). This is selected in Setup. The ms or the BPM icon next to the Delay time will be lit accordingly. The tempo is also indicated via the blinking TEMPO /RHYTHM indicator.

SUBDIVISION indicator

The selected subdivision determines the recalculation of the tapped tempo. Example: At 120BPM you tap 1/4 notes. The tapped time equals 500ms. If the Subdivision is set to 1/8, the D•TWO now recalculates the Delay time to 250ms.

DYNAMIC meter

Indicates the gain reduction on the Delay Output when using the Dynamic Delay algorithm.

EDITED icon

This icon will be lit as soon as the current recalled preset has been modified.

FACTORY/USER icon

Shows whether you are operating in the Factory or the User bank.

MIDI IN icon

Indicates the presence of incoming MIDI information.

SAMPLE RATE indicator

The SAMPLE RATE indicator shows the clock source and the incoming master clock. The "DI" icon will be blinking if no clock or unacceptable clock is found.

FEEDBACK %

The amount of level fed back to the Delay line. Indicates the Decay time of the Delay repeats.

FEEDBACK

The exact number of repeats.

FB FILTER LEDS

Indicates the Feedback High and Low Cut filter setting.

FILTER LEDS

Indicates the overall High and Low Cut filter setting.

PINGPONG LEDS

Indicates the panning carried out.

FRONT PANEL

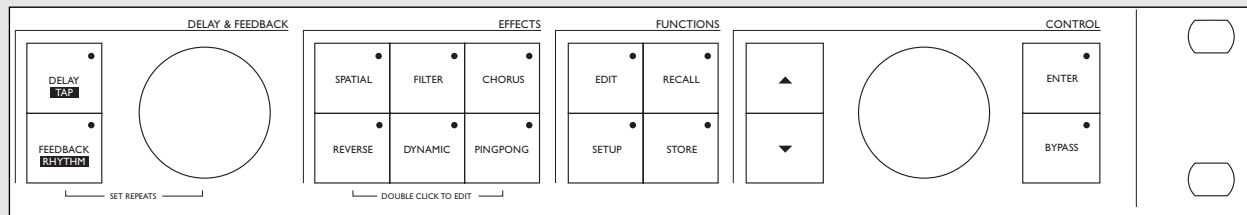

DELAY/TAP key

This key has two main functions:

- When the DELAY key LED is lit, the DELAY wheel changes the Delay time when dialed.
- When the key is tapped the D•TWO measures the time between the last two taps and the Delay time is calculated according to the selected subdivision.

FEEDBACK/RHYTHM key

This key has three main functions:

- When the LED is lit the DELAY wheel is changing the Feedback level or %.
- When the key is pressed and held, the DELAY wheel changes the number of repeats.
- Tap a rhythm pattern of up to 10 taps.

DELAY & FEEDBACK wheel

Sets the Delay time or Feedback depending on what is selected.

SPATIAL key

Enables/disables the Spatial function. Double click shortcuts to the Spatial parameters.

Options are:

- Left channel offset +/-200ms.
- Phase reverse any channel.

FILTER key

Enables/disables the Filter functions. Double click shortcuts to the High and Low Cut filter parameters.

CHORUS key

Enables/disables the Chorus. Double click shortcuts to the Chorus parameters.

REVERSE key

Enables/disables the Reverse Delay. Double click shortcuts to the Reverse Delay parameters.

DYNAMIC key

Enables/disables the Dynamic Delay. Double click shortcuts to the Dynamic Delay parameters.

PING PONG key

Enables/disables the PingPong functions. Double click shortcuts to the PingPong parameters.

EDIT key

Enters the general Edit list. This is where all preset processing parameters are located. Use the ARROW keys to select parameters.

RECALL key

Selects the Recall menu.

SETUP key

Enters the Setup menu. This is where all I/O and global parameters are located.

STORE key

Selects the Store menu. Presets can be stored in the User bank only. Location is selected using the CONTROL wheel. Operation is confirmed using ENTER.

ARROW UP/DOWN keys

Are used to move the cursor around in the display.

CONTROL wheel

Is used to change values.

ENTER key

Confirms operations.

BYPASS key

Bypasses the unit. There are three different Bypass modes.

- 0% Mix: Input signal is passed directly to the Output.
- FX Input: Input bypass allowing the effects to ring out.
- FX Output: Kills the effect but keeps the direct signal level.

The Bypass mode is selected in the Setup menu.

REAR PANEL

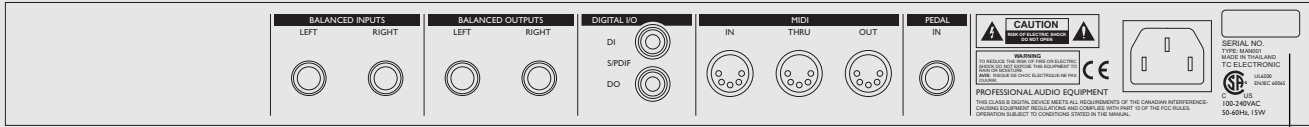

Balanced Jack Analog Inputs

(Use Left Input for Mono)

Balanced Jack Analog Outputs

Digital S/PDIF Input/Output

MIDI In, Out, Thru

Pedal Input

Power Input

Serial no.

MIDI Cable

DIN CONNECTOR
5POLE - MALE
45 degrees

max. 10m

DIN CONNECTOR
5POLE - MALE
45 degrees

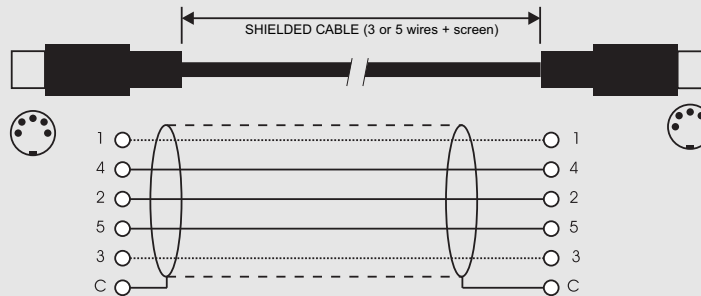

Jack (unbalanced) - XLR

Sleeve - Pin 1 (Ground)
Tip - Pin 2 (Hot)
Sleeve - Pin 3 (Cold)

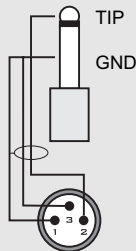

Jack (balanced) - XLR

Sleeve - Pin 1 (Ground)
Tip - Pin 2 (Hot)
Ring - Pin 3 (Cold)

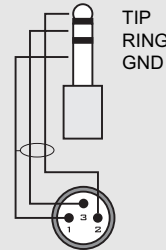

SIGNAL FLOW

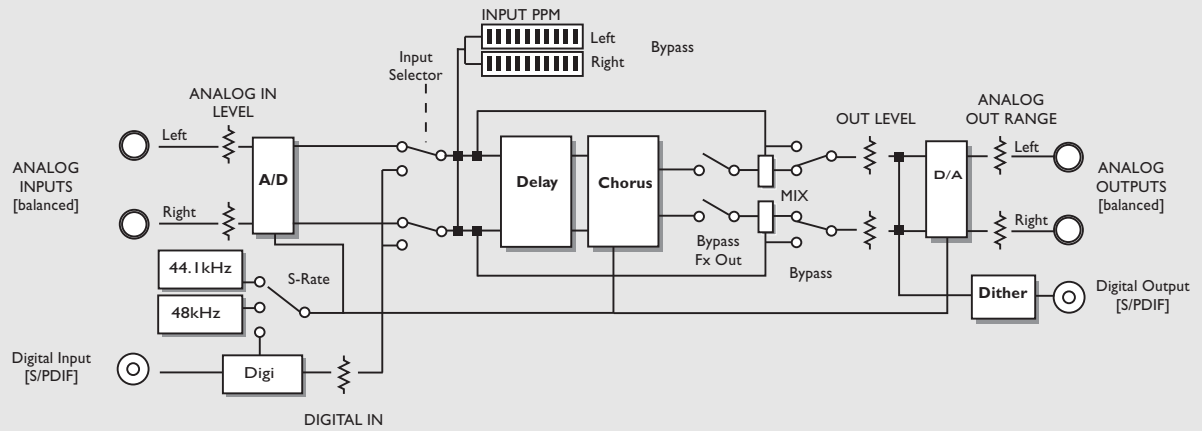

D•TWO - SETUP

Setting up the D•TWO

Connect the D•TWO as illustrated using balanced 1/4" jack cables.

Mode selection

The D•TWO has three Delay modes: Traditional, Straight and Rhythm.

Traditional mode

The standard setup used by any Delay unit, including the traditional feedback strategy.

Straight mode

The D•TWO default mode, including the ability to control the exact number of repeats.

Rhythm mode

A unique feature allowing you to tap a specific rhythm of your choice. The D•TWO automatically enters the Rhythm mode when FEED-BACK/RHYTHM is tapped.

Please note that the Mono/Stereo mode is selected in the Setup menu.

Stereo Mode

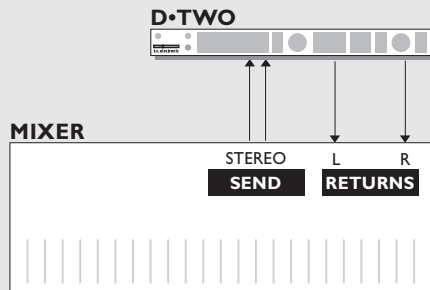

Mono Mode - use Left Input

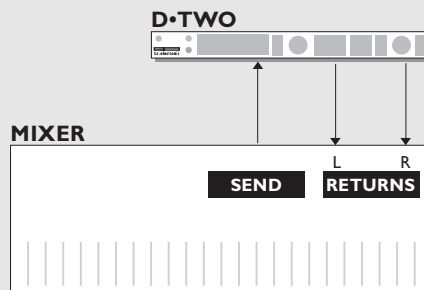

THE D•TWO DISPLAY

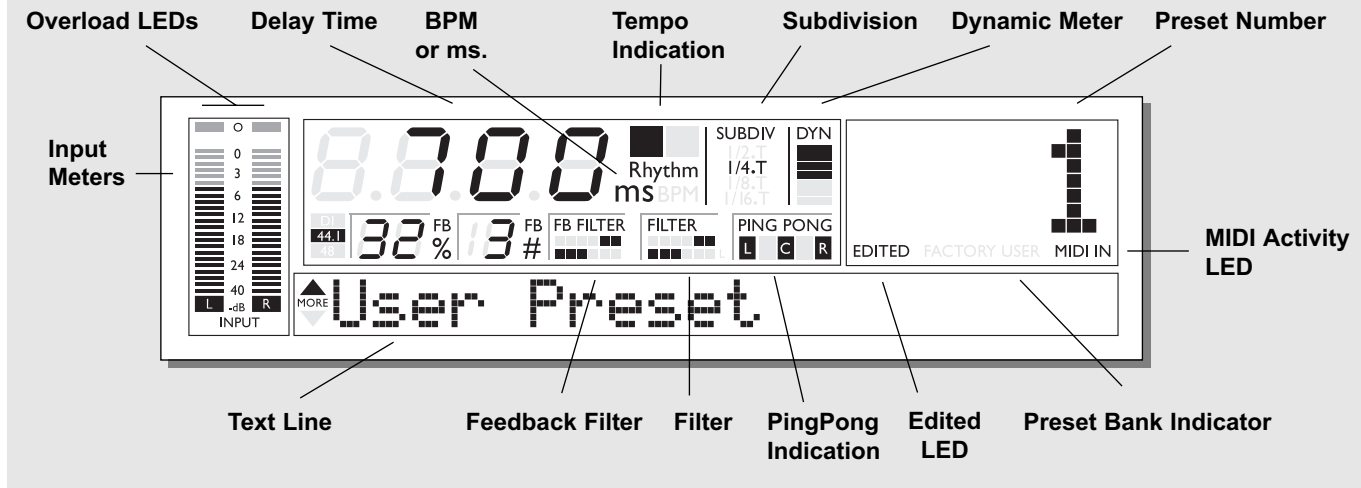

Delay Time

The DELAY TIME indicator displays the main Delay time in either ms or BPM (beats per Minute= 60/ms*1000). When in Rhythm mode, the DELAY TIME indicator, displays the total time of the full pattern, or the total number of subdivisions in the current Rhythm pattern.

Tempo Indicator

The Tempo indicator is blinking at the current tempo (BPM/ms).

Rhythm Icon

The Rhythm icon is lit when the D•TWO is in Rhythm mode.

Subdiv

Shows the current Subdivision being used.

Tap the beat in 1/4 notes and the D•TWO will recalculate the Delay time in accordance to the Subdivision. In Rhythm mode the Subdivision sets the Quantization grid.

Example

Tap 500ms (120 BPM measured in 1/4notes) with the Subdivision set to 1/8. The D•TWO recalculates the Delay time to 250ms. To set the recalculated Delay time press EDIT and use the CURSOR keys to select the Delay time parameter.

Dyn

The Dynamics meter indicates the amount of gain reduction on the Output of the D•TWO, when the Dynamic Delay time is active.

Preset Number

These three seven segments will display the current preset. The icons below will indicate whether it is Factory or User presets.

Edited

This icon will be lit as soon as the current preset has been modified but not yet stored.

Factory/User

Shows whether you are operating in the Factory or User bank.

MIDI In

Shows incoming MIDI information.

Text Line

This 20 character text line is used to display preset names, parameter names etc.

THE D•TWO DISPLAY

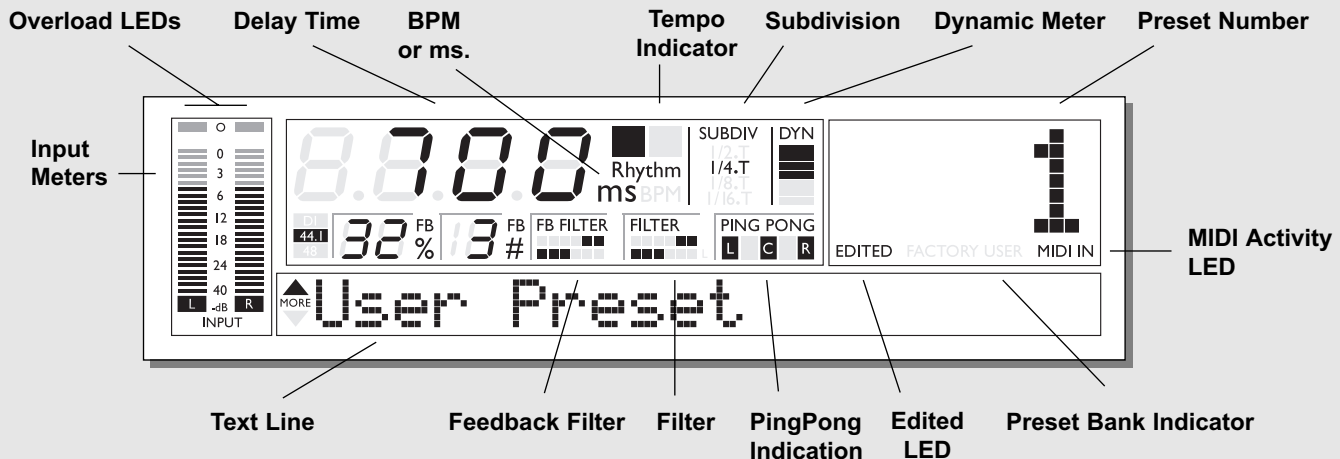

DI 44.1/48 Icon

Indicates whether the D•TWO is locked to an external clock or not. When locked to an external clock the incoming Sample Rate is displayed by either the 44.1 or 48 icon. If the clock is unacceptable or no clock is available, the "DI" indicator will be blinking.

ms Icon

The ms icon is lit when the 4 digits show the Delay time in milliseconds.

BPM Icon

The BPM icon is lit when the 4 digits show the Delay time in Beats per Minute.

Feedback %

Indicates the amount of level fed back to the Delay line, thus controlling the Decay of the Delay repeats.

Feedback

Indicates the number of repeats allowed. Unlike the Feedback parameter in most other Delay units this parameter lets you decide exactly how many repeats you want. The maximum number of controlled taps is 10.

FB Filter

Indicates the Feedback High Cut and Low Cut filter setting. At times a too precise/clear Delay can disturb the music instead of complementing it. Try reducing the highs of the Delay by adding a High Cut filter. This will simulate a more analog/softer feeling.

Filter

Indicates the overall High Cut and Low Cut filter setting.

PingPong

Indicates the currently selected type of panning. The Ping Pong effect occurs when the Panning Speed is synced to the Delay time.

SETUP

Setup

The Setup menu holds all general Setup-parameters including parameters normally found in Utility, Level and I/O menus.

Basic Operation

- Press the SETUP key to enter the Setup page.
 - Use the ARROW keys to select parameter.
 - Use the CONTROL wheel to change parameter value.
- All changes are instantly carried out.

Mono/ Stereo In

The channel select on Analog Inputs is done automatically via sensing on the Input connectors.

Input Select

Dial the CONTROL wheel to select between Analog or Digital.

Analog Input

When "Analog" is selected the D•TWO automatically defaults to the internal 44.1kHz clock as Sample Rate.

Digital Input

When "Digital" is selected the D•TWO attempts to lock to the S/PDIF Input. During the lock-up period the "DI" display icon blinks indicating none or unacceptable clock, and the Outputs are muted.

When lock is achieved the "DI" icon turns solid, and the Outputs are un-muted.

Clock

Analog Input

When Input source is analog the following Sample Rates are available:

Internal 44.1kHz - The D•TWO runs at internal 44.1kHz.

Internal 48kHz - The D•TWO runs at internal 48kHz.

Digital - The D•TWO locks to the incoming Digital clock.

Digital Input

When Input Source is digital the following Sample Rates are available:

Internal 44.1kHz - The D•TWO runs at internal 44.1kHz.

Internal 48kHz - The D•TWO runs at internal 48kHz.

Digital - The D•TWO locks to the incoming Digital clock.



Please note that when using internal clock with external digital audio, the incoming digital audio must be in sync with the D•TWO internal clock in order to avoid slip-samples.



Rate Mismatch*

This Error message will occur in the display if the D•TWO detects slip-samples. Typically this problem only occurs in very special clock setups e.g. if the D•TWO is running via internal clock, while processing audio from the Digital Input. If the incoming clock and the internal clock does not match the D•TWO will display the above written error message.

Out Range

Sets the maximum Gain range of the analog Output stage. Range: 2dBu, 8dBu, 14dBu and 20dBu.

Analog Out Level

Adjusts the Analog Output level.

Digital In Gain

Adjusts the Digital In level. This parameter is only active when Digital In is selected.

Dither

Going from one type of bit resolution to a lower, e.g. from 24 bit to 16 bit, you actually lose 8 bits of information. The process of cutting off bits is called truncation and it introduces digital distortion of low level signals, due to the lack of complete signal information. To compensate for this, "dither" must be applied. Dither is a small amount of filtered noise that generates randomization at the noise floor, ensuring a less distorted low level signal.

Dithering is relevant only on digital Outputs and it is always the receiving device that determines the number of bits you must dither to. A CDR or a DAT recorder should normally be dithered to 16 bit.

Status Bits

Sets whether the D•TWO is sending out AES/EBU (professional standard) or S/PDIF (consumer standard) status bits.

Delay Unit

Select ms (milliseconds) or BPM (Beats Per Minute).

SETUP

Delay Mode

Select between Stereo or Mono.

Reverse Offset

Offsets the Reverse Delay with 0-200ms. This enables you to tailor the feel of the Reverse Delay to the source material.

MIDI Tempo Sync.

Range: 2/1, 1/1, 1/2, 1/4.

Locks the Delay to the incoming MIDI clock, enabling the D•TWO to be synchronized to any MIDI device, e.g. a sequencer.

The D•TWO owns the ability to subdivide the incoming MIDI clock in order to adapt the Delay to very fast or very slow tempo arrangements, e.g. selecting the 1/2 setting will lower the incoming sync to half tempo.

MIDI Channel

Range: Off/1-16/Omni.

Sets the responding MIDI channel of the D•TWO.

MIDI CC

Range: On/Off.

Determines whether the D•TWO should respond to MIDI Continuous Controllers or not.

Program bank

Determines which bank an external MIDI device will address in the D•TWO when sending a program change. The options are: Factory, User or External.

When External is selected controller #32 can be used to address either the Factory or the User bank.

Factory bank: Controller #32=0

User bank: Controller #32=1

MIDI Bulk Dump

Press ENTER to perform a Bulk Dump of all presets to an external MIDI device. The D•TWO is always ready to receive MIDI Bulk Dump information.

MIDI Sys-Ex ID

Determines the Sys-Ex ID number of the unit.

All effects parameters can be changed through MIDI Sys-Ex via an external MIDI device. In order to define which unit the sent MIDI Sys-Ex information should reach, the appropriate ID number must be set.

Bypass Mode

There are three different Bypass modes:

0% Mix

The Input signal is passed directly to the Output.

FX Input

Shuts off the Engine Input in order to let the effect "ring out", but leaves the same amount of dry signal through the unit.

FX Output

Shuts off the Engine Output in order to kill the FX instantaneously, but leaves the same amount of dry signal coming through.

Pedal Setup

The pedal Input of the D•TWO can recognize two pedals simultaneously. One on the tip, and one on the ring of the 1/4" jack connector.

The Ring pedal is fixed to Tap tempo.

The Tip pedal can be set to Bypass, Tap tempo or Rhythm tap. The Pedal used must have a momentary switch.

View Angle

Adjusts the intensity of the back light.

RECALL - EDIT - STORE

Recall

Basic operation

- Press RECALL to enter the Recall page.
- Use the CONTROL wheel to select preset.
Blinking preset number and simultaneously blinking ENTER key LED indicates that you are previewing the preset and that it is not yet recalled/activated.
- Press ENTER or RECALL to recall the preset.

Preset types

User presets - RAM

User presets that can be edited and stored in any User location. You can store up to 100 User presets.

Factory presets - ROM

Factory presets that can be edited and stored in any User location. You cannot store presets into a Factory location. The D•TWO holds 50 Factory presets.

Edit

There are two groups of parameters to edit. Parameters for the additional effects and the Delay specific parameters.

EDIT keys for additional effects

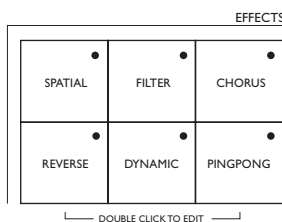

EDIT key for Delay specific parameters

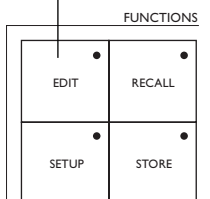

Delay specific parameters

Click on the EDIT key. Use the CURSOR keys to select parameter and use the CONTROL wheel to change value.

Parameters in the additional effects

Double click on the effect key. Use the CURSOR keys to select parameter and use the CONTROL wheel to change value.

Store

Preset types

User presets - RAM

User presets that can be edited and stored in any User location. You can store up to 100 user presets in the User bank.

Factory presets - ROM

Factory presets that can be edited and stored in any User location. You cannot store presets into a Factory location. The D•TWO holds 50 factory presets.

Preset Locations

Presets can be stored in User locations only.

The Store page automatically suggests the first free User location in the memory as storing space unless the currently recalled preset is a User preset. In that case the same User location is suggested.

Storing an edited preset with the same name at the same location

- Press STORE to enter the Store menu.
- Press ENTER twice to store the preset. The display reads "Stored" shortly and returns to the Recall page.

Storing a preset with the same name at a new location

- Press STORE to enter the Store menu.
- Use the CONTROL wheel to select storing location.
- Press ENTER twice to store the preset, the display reads "Stored" shortly and returns to the Recall page.

Storing a preset with a new name

- Press STORE to enter the Store menu.
- Select storing location using the CONTROL wheel.
- Press the STORE key again or the ARROW DOWN key to enter the "Naming" display.
- Use the ARROW keys to change cursor position.
- Dial the CONTROL wheel to select characters.
- Press ENTER to store the preset.

Available characters: ABCDEFGHIJKLMNOPQRSTUVWXYZ
abcdefghijklmnopqrstuvwxyz 0123456789 /*.-:"#%&()_

DELAY MODES

The D•Two holds 3 basic Delay modes

- Traditional Delay mode

In this mode the D•TWO operates as a regular Delay unit.

- Straight Delay mode

In this mode you will have total control over each tap.

- Rhythm mode

In this mode you are able to tap a specific rhythm into the unit. Afterwards full control of all taps are available.

Traditional Delay Mode

The Traditional Delay mode, makes the D•TWO work as any regular Delay unit. The delayed signal is fed back into the Delay line by the FEEDBACK % knob, thus creating Delay repeats.

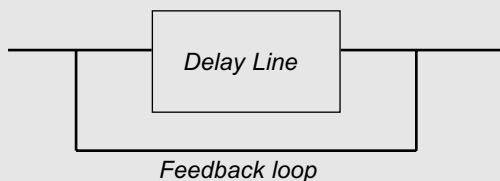

How to enter Traditional mode

When coming from Straight Delay mode

Set the FEEDBACK # to "-" by pressing and holding the FEEDBACK/RHYTHM key while dialing the DELAY wheel counter clockwise. When "-" is selected the D•TWO is in Traditional Delay mode.

When coming from Rhythm mode

To enter Traditional Delay mode from Rhythm mode you must first go to Straight Delay mode by pressing DELAY TAP twice. Then press and hold the FEEDBACK RHYTHM key while turning the DELAY wheel counter clockwise. When "-" is selected the D•TWO is in Traditional Delay mode.

The Maximum Delay time of the Traditional mode is:

Stereo mode: 5 sec. Delay time.

Mono mode: 10 sec. Delay time.

Stereo/Mono is selected in the SETUP menu.

The Parameters

The parameters of the Traditional Delay mode is, as the name suggests, quite similar to those of any other Delay unit.

Delay - Delay Time

Tap the DELAY/TAP key, or press the DELAY key once and dial the DELAY wheel to change the basic Delay time. The maximum tap time is 2000ms.

Feedback Level

Hit the FEEDBACK/RHYTHM key and dial the DELAY wheel to change the amount of signal fed back into the Delay line. An 100% setting will loop the Delay line.

Feedback Repeats

If the Feedback Repeats setting differs from "-" you have specified the number of repeats and you are no longer in the Traditional mode.

Shuffle

The Shuffle parameter has no effect in the Traditional Delay mode.

Quantize

The Quantize parameter has no effect in the Traditional Delay mode.

Track Tap

The Track Tap parameter allows the preset to instantly track the current basic tempo, and adapt to this as opposed to using the tempo which the current preset was stored with.

This enables you to use a number of presets without having to tap the overall tempo more than once.

RhythmDcay - Rhythm Decay

The RhythmDcay parameter has no effect in the Traditional mode.

Subdivision

The Subdivision recalculates the basic Delay time accordingly. BPM equals 1/4 subdivision. To see the recalculated Delay time - press EDIT and use the CURSOR keys to select the Delay time parameter.



Press and hold the DELAY/TAP key and dial the DELAY wheel, to change the Subdivision.

DELAY MODES

Additional Effects

To the Traditional Delay mode the effects described below can be added:

Please see detailed description on the following pages.

Spatial:

Gives the Delay a wider feeling either by using “left channel offset” or “Phase Reverse” of left, right or both channels.

Filter:

Enables a High and a Low Cut filter in the Feedback loop and in the actual Delay line.

Chorus:

Adds Chorus, to smooth the Delay repeats.

Dynamic:

A ducking function that reduces the Output level of the Delay with a specified level when the Input signal exceeds a certain Threshold.

PingPong:

The PingPong effect is not available in the Traditional mode.

Straight Delay Mode

The Straight Delay mode, utilizes a feedback strategy that gives you all the normal controls of a Delay and on top of that, the ability to control the exact number of repeats. Instead of a traditional feedback loop, the Straight mode uses a multitap strategy.

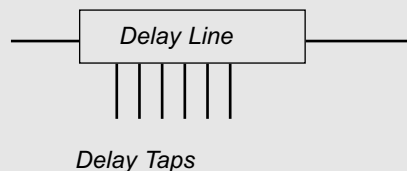

How to set up the Straight mode

Set the FEEDBACK # to anything between 1 and 10 by pressing and holding the FEEDBACK/RHYTHM key while dialing the DELAY wheel. The D•TWO is now in the Straight mode.

Max. Delay time

Due to the multitap Delay strategy, the maximum Delay time available is scaled with the number of specified taps, e.g. if you have 10 repeats you will have 1000ms available on each tap, while 5 repeats would give you 2000ms on each tap.

The maximum Delay time in total is:

In Stereo mode: 5 sec. Delay time.

In Mono mode: 10 sec. Delay time.

Stereo/Mono is selected in the SETUP menu.

The Parameters

The Straight Delay mode allows you to control the exact number of repeats and additionally offers the ability to add shuffle feel to the Delay repeats.

Delay Time

Tap the DELAY/TAP key, or press the DELAY/TAP key once and dial the DELAY wheel to change the basic Delay time. The maximum tap time pr. tap is 2000ms.

Feedback Level

Hit (one time only) the FEEDBACK/RHYTHM key and use the DELAY wheel to change the Decay of the repeats. A 100% setting will leave every repeat at maximum level.

DELAY MODES

Feedback

Press and hold the FEEDBACK/RHYTHM key and dial the DELAY wheel to change the exact number of Delay repeats. The maximum number of repeats is 10 or limited by the total Delay time. In case of limited repeats, the FEEDBACK # parameter will be blinking.
E.g. 10 repeats of 1500ms = >10 seconds.

Shuffle

The Shuffle parameter allows you to add shuffle feel to the straight Delay repeats. The shuffle feel is added to every second repeat, by offsetting the repeat according to the percentage of the shuffle parameter.
The Shuffle parameter only works on straight Subdivisions i.e. 1/2, 1/4, 1/8, 1/16.

Quantize

The Quantize parameter has no effect in the Straight mode.

Track tap

The Track tap parameter allows the preset to instantly track the current basic tempo, and adapt to this, as opposed to using the tempo that the current preset was stored with.
This enables you to use a number of presets without having to tap the overall tempo more than once.

RhythmDcay

The RhythmDcay parameter has no effect in the Straight mode.

Subdivision

The Subdivision recalculates the basic Delay time accordingly. BPM equals 1/4 subdivision.



Press and hold the DELAY/TAP key and dial the DELAY wheel, to change the Subdivision.

Additional Effects

To the Straight Delay mode the effects described below can be added:

Please see detailed description on the following pages.

Spatial:

Gives the Delay a wider feeling either by using “left channel offset” or “Phase Reverse” of left, right or both channels.

Filter:

In a traditional feedback loop, the signal will pass the feedback filter each time it passes through the feedback loop. This is perceived as if the signal is gradually filtered more and more, repeat after repeat. This effect can be achieved in the Straight mode by using the FB filters.

Chorus:

Adds Chorus, to smooth the Delay repeats.

Dynamic:

A ducking function that reduces the Output level of the Delay with a specified level when the Input signal exceeds a certain Threshold.

PingPong:

The PingPong effect synchronizes panning with the tempo of the Delay repeats.

DELAY MODES

Rhythm Mode

The Rhythm mode offers a new unique feature to Delay control i.e. Rhythm Delay. Tap the rhythm that you want the D•TWO to perform on the FEEDBACK/RHYTHM key. On top of this the D•TWO can help you quantize the rhythm pattern to a specific subdivision, edit the rhythm pattern, or change the level of each tap in the rhythm pattern.

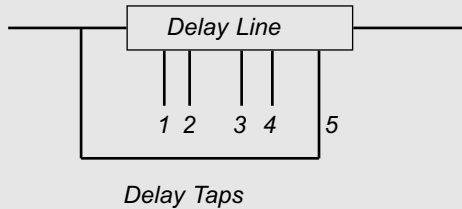

How to set up enter Rhythm mode

Simply tap the FEEDBACK/RHYTHM and the D•TWO will instantly create the rhythm pattern that you tap. The Rhythm mode is indicated by the "RHYTHM" icon in the Delay time display. Press and hold or tap the DELAY/TAP key to exit the Rhythm mode.

Max. Delay time

Due to the multitap Delay strategy, the maximum Delay time available is scaled with the number of specified taps, e.g. if you have 10 taps, you will have 1000ms available on each tap, while 5 repeats would give you 2000ms on each tap.

The maximum Delay time in total is:

In Stereo: 5 sec. Delay time.

In Mono: 10 sec. Delay time.

Stereo/Mono is selected in the SETUP menu.

The Parameters

The Rhythm mode allows you to tap and edit a specific rhythm pattern. The maximum number of taps in a pattern is 10 taps.

Delay Time

Sets the basic tempo of the tapped rhythm. When using Quantize the basic tempo must be tapped/set before

tapping the rhythm. The basic tempo is indicated when the DELAY/TAP key is enabled. The maximum tap time pr. tap is 2000ms.

Feedback %

Sets the Decay of the rhythm pattern depending on the RhythmDecay parameter.

Feedback

Indicates the total number of taps utilized in the rhythm pattern. While tapping the rhythm, the Feedback # will be counting the number of taps in the current rhythm. Additionally the Delay time display will be indicating the total time of the over all rhythm pattern. When Quantize is inactive the total time will be displayed in ms or BPM. When Quantize is active, the total time will be expressed in number of subdivision e.g. total number of 1/16th notes.

Shuffle

The Shuffle parameter allows you to add shuffle feel to the straight Delay repeats. The shuffle feel is added to every second repeat, by offsetting the repeat according to the percentage of the shuffle parameter.

The Shuffle parameter only works on straight Subdivisions i.e. 1/2, 1/4, 1/8, 1/16.

Quantize

The Quantize parameter allows you to quantize the tapped rhythm according to a specific subdivision e.g. 1/16 notes.

In order to take full advantage of the Quantize function, a base tempo must be tapped before tapping the actual rhythm.

The Quantize function is non-destructive during edits, meaning that the original tap values are maintained until the quantized rhythm is stored in a preset, enabling you to check out several quantizations before the setting is stored.



In order to use Quantize you must tap a regular tempo on the DELAY/TAP key before you tap the rhythm.

DELAY MODES

Track tap

The Track tap parameter allows the preset to instantly track the current basic tempo, and adapt to this, as opposed to using the tempo that the current preset was stored with.

This enables you to adapt a specific Rhythm pattern to any tempo.

RhythmDcay - Rhythm Decay

This parameter sets the Decay style of the Rhythm pattern. A Rhythm pattern is always fed back from the last tap, meaning that the entire pattern is repeated when Feedback % is different from 0.

Normal

When the Normal Decay style is selected, the Rhythm pattern will decay, tap by tap, as a standard Delay. When Feedback % is set to "0", the pattern will decay over the total pattern time (total pattern time is indicated in the Delay time display when the FEEDBACK/RHYTHM is selected).

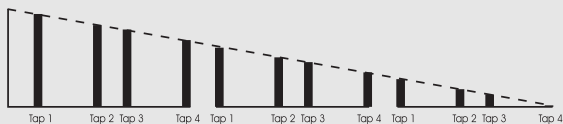

Step

When Step Decay style is selected, the Rhythm pattern will decay pattern by pattern, meaning that all taps in a pattern will be played back at equal level. The level is lowered as the pattern is repeated.

When Feedback % is set to "0", the current pattern will be played back once at full level.

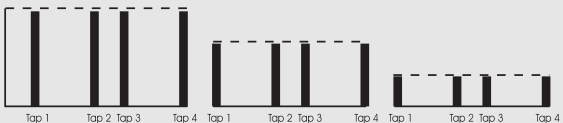

Subdivision

In Rhythm mode the Subdivisions are used as the quantization grid. This means that when Quantize is active, the Subdivision determines the smallest increment that a tap can be, e.g. if the base tempo is 500ms (120BPM) and the Subdivision is set to 1/16, the shortest time of a Rhythm tap will be 125 ms (500/4=125ms).



Press and hold the DELAY/TAP key and dial the DELAY wheel, to change the Subdivision.

Rhythm Tap Edit

When in the Rhythm mode the tapped Rhythm pattern can be edited tap by tap. This gives you the possibility to change the Rhythm pattern that you just tapped, or to build a new pattern from scratch.

The Tap Edit menu contains three parameters for each tap: The Tap number, the Tap level, the Tap time.

How to enter/exit Tap Edit

Press and hold the FEEDBACK/RHYTHM key to enter the Tap Edit menu. The Feedback # parameter will be blinking while in Tap Edit.

Press any key (except ARROW UP/ARROW DOWN) to exit the Tap Edit menu.

The Tap number

Indicates the number of the current Tap. Use the DELAY wheel to scroll through the ten taps.

The Delay time display indicates the total Delay time of the Rhythm pattern up to the end of the selected Tap, in either ms/BPM or number of Subdivisions (depending on whether Quantize is on or off).

The Tap level

Sets the level of the current Tap. Press the ARROW UP/ARROW DOWN keys to edit the level.

When a tap is muted, it is still valid as a time factor. This can be used for "filling up" a bar e.g. if you feed back a Rhythm pattern that contains six 1/8th notes in a 4/4 pattern, the rhythmic feel will change, as the pattern does not fit a whole bar. Alternatively a muted Tap of 2/8 can be placed as the last tap, giving no audio, but creating a full bar repeat length i.e. $8/8 (2/8+6/8=8/8= 1 \text{ bar})$.

The levels available are:

Mute, -12dB, -6dB, -3dB, 0dB(default), +3dB and +6dB.

The Tap time

Sets the time from the previous to the current tap. When Quantize is inactive, the Tap time is set in ms increments. When Quantize is active, the Tap time is set in the current

DELAY MODES

Subdivision e.g. number of 1/8th notes.
Dial the CONTROL wheel to change the Tap time.
Turning the Tap time fully counter clockwise, will set the Tap to “Off” meaning that the current Tap is disabled.
Taps cannot change order. This means that if a tap is placed “on top” of a second tap, the second tap automatically will be set to “Off”.

Additional Effects

To the Traditional Delay mode the effects described below can be added:

Please see detailed description on the following pages.

Spatial:

Gives the Delay a wider feeling either by using “left channel offset” or “Phase Reverse” of left, right or both channels.

Filter:

Enables a High and a Low Cut filter in the Feedback loop and in the actual Delay line.

Chorus:

Adds Chorus, to smooth the Delay repeats.

Dynamic:

A ducking function that reduces the Output level of the Delay with a specified level when the Input signal exceeds a certain Threshold.

PingPong:

The PingPong effect is not available in the Traditional mode.

PingPong

Basic operation

Entering the PingPong menu can be done in two ways:

- Press PINGPONG and scroll to the Pingpong parameters.
 - Double click the PINGPONG key for shortcut.
- The PINGPONG key also works as on/off for the PingPong function.

PingPong basically means that the Delay is panned in accordance with the Tapped Delay time.

Style

Range: L-R, L-C-R and Dynamic

The Style parameter determines how the signal is panned.

L-R

The L-R mode will pan the signal hard left, hard right.

L-C-R

Pannes the taps left, center and right accordingly.

Dynamic

This setting will fit the number of Delay repeats with the number of panning positions. For example a Delay with 5 repeats would use 5 pan positions from left to right.



Please note that PingPong is in-active in the traditional Delay mode.

DELAY MODES

Dynamic

Basic operation

Entering the Dynamic menu can be done in two ways:

- Press EDIT and scroll to the Dynamic parameters.
- Double click the DYNAMIC key for shortcut.

The DYNAMIC key also works as on/off for the Dynamic function.

The Dynamic Delay is a ducking function that reduces the Output level of the Delay with a specified level (Damping) when the Input signal exceeds a certain Threshold (Threshold).

Threshold

Range: -40 - 0dB

Sets the Input Threshold that must be exceeded to activate the “Ducking”.

Release

Range: 20ms - 7sec.

Sets the Release time of the “Ducking” function.

Damping

Range: -60 - 0dB

Sets the amount of damping added to the signal during “Ducking”.

Reverse

Basic operation

Entering the Reverse menu can be done in two ways:

- Press EDIT and scroll to the Reverse parameters.
- Double click the REVERSE key for shortcut.

The REVERSE key also works as on/off for the Reverse function.

The Reverse function plays back triggered reversed chunks of the audio. There is a number of different playback styles to choose from. Additionally the Reversed taps can be offset in order to tailor the rhythmic feel of the Delay. The Offset parameter is located in the Setup menu.

RvrsThres - Reverse Threshold

Sets the trigger level of the Reverse Delay.

In order to retrigger the Reverse Delay, the signal must drop 6dB below the current Threshold, and then trigger the Threshold again.

In Rhythm and Traditional mode, the Reverse Delay can be re-triggered by both the signal, and by the Feedback. This means that once the Reverse Delay is running, the Feedback parameter will allow the Reverse Delay to ring out like a normal Delay.

Rvrs Style

The Reverse Style enables you to choose from a number of different Reverse strategies:

All

All taps are played back in reverse style.

1st/1st Trg

The first tap is reversed, while the rest of the taps are played back as normal Delay taps.

The “Trg” determines whether the forward taps are triggered like the reversed taps or, simply free wheeling like a normal forward Delay.

2nd/2nd Trg

The second tap is reversed, while the rest of the taps are played back as normal Delay taps.

The “Trg” determines whether the forward taps are triggered like the reversed taps or, simply free wheeling like a normal forward Delay.

DELAY MODES

Last/Last Trg

The Last tap is reversed, while the rest of the taps are played back as normal Delay taps.

The “Trg” determines whether the forward taps are triggered like the reversed taps or, simply free wheeling like a normal forward Delay.

Odd/Odd Trg

The Odd numbered taps are reversed, while the even of the taps are played back as normal Delay taps.

The “Trg” determines whether the forward taps are triggered like the reversed taps or, simply free wheeling like a normal forward Delay.

Even/Even Trg

The Even numbered taps are reversed, while the odd of the taps are played back as normal Delay taps.

The “Trg” determines whether the forward taps are triggered like the reversed taps or, simply free wheeling like a normal forward Delay.

SHORTCUTS

Jump to User Bank

While in the Recall menu, hit ARROW UP to jump straight to User preset 1.

Jump to Factory Bank

While in the Recall menu, hit ARROW DOWN to jump straight to Factory preset 1.

Change Feedback #

Press and hold the FEEDBACK/RHYTHM key and use the DELAY wheel, to change number of Repeats.

Change Subdivisions

Press and hold the DELAY/TAP key and dial the DELAY wheel, to change the Subdivision.

Edit Additional Effects

Double click the key of the Effect you wish to edit.

Exit Rhythm Mode

Press and hold the DELAY/TAP for 1.5 second, to exit the Rhythm mode.

Enter Tap Edit

Press and hold the FEEDBACK/RHYTHM key for 1 second, to enter the Tap Edit menu.

Exit Tap Edit

Press any key, to exit the Tap Edit menu.

ADDITIONAL ALGORITHMS

To each of the described Delay modes the following effects can be added.

Spatial

Basic operation

Entering the Spatial menu can be done in two ways.

- Press EDIT and scroll to the Spatial parameters.
- Double click the SPATIAL key for shortcut.

The SPATIAL key also works as on/off for the Spatial function.

Offset L

Range: +/-200ms

Offsets the Left channel by +/- 200ms. The Offset is always added to the Main Delay time. The Offset is independent of the Tap function.

Phase Reverse

Range: L, R L&R

With the Phase Reverse parameter you can reverse the phase of the Delay left, Delay right or the entire Delay signal.

Filter

Basic operation

Entering the Filter menu can be done in two ways.

- Press EDIT and scroll to the Filter parameters.
- Double click the FILTER key for shortcut.

The FILTER key also works as on/off for the Filter function.

FB High Cut - Feedback - High Cut

Range: 19.95Hz - 20kHz

High Cut type filter that allows you to reduce the high frequencies of the Delay. This gives you a softer and more analog sounding Delay which in some cases will seem less disturbing on the overall sound, than a Delay with no High Cut.

FB Low Cut - Feedback - Low Cut

Range: 19.95 - 20kHz

Low Cut type filter reducing the low end frequencies of the Delay. When using Delay on signals with low frequencies a full-range Delay might introduce a less tight feeling in that area. Use the Low Cut filter to avoid this.

High Cut

Range: 19.95Hz - 20kHz

High Cut filter allowing reduction of the high end frequencies on the source material.

Low Cut

Range: 19.95Hz - 20kHz

Low Cut filter allowing reduction of the low end frequencies in the source material.

Chorus

Basic operation

Entering the Chorus menu can be done in two ways.

- Press EDIT and scroll to the Chorus parameters.
- Double click the CHORUS key for shortcut.

The CHORUS key also works as on/off for the Chorus function.

Speed

Range: 0.05Hz - 19.95Hz

Sets the Speed of the Chorus.

Depth

Range: 0 - 100%

Sets the Depth of the Chorus.

Amount

Range: 0-100%

Sets the amount of Chorus added to the Delay signal.

Feedback

Range: -100 to +100

The amount of processed signal that is fed back to the Input of the Chorus. When the feedback value is negative, the Feedback signal is phase reversed. Use the Feedback parameter to create a Flange effect.

Chorus Time

Range: 0 - 50ms

A Chorus is basically a Delay being pitch-modulated by an LFO (Low Frequency Oscillator). The typical Delay time used in a Chorus is around 10-20ms. A Flanger typically uses a Delay time of approx. 5-10ms.

ADDITIONAL ALGORITHMS

Golden Ratio

Ensures a Golden Ratio between the Speed and Depth when active. If you want to create wild Chorus/Flanger sounds, you may want to turn the Golden Ratio off.

Ph Reverse - Phase Reverse

Reverses the phase of the left Chorus channel. This widens the stereo image of the Chorus/Flanger.

LFO Curve

Sets the curve of the LFO. Choose between Sine or Triangle.

LFO Phase

An LFO phase change, offsets one of the two LFO's slightly (left/right). This means that left/right starts the current waveform at two different points.

Example: If LFO phase is set to 180 degrees, left and right LFO will be exactly opposite.

IMPORTANT SAFETY INSTRUCTIONS

Please read, keep, and follow these instructions before connecting this unit. Heed all warnings and instructions. Retain this notice and the owner's manual for future reference.



The lightning flash with an arrowhead symbol within an equilateral triangle, is intended to alert the user to the presence of uninsulated "dangerous voltage" within the product's enclosure that may be of sufficient magnitude to constitute a risk of electric shock to persons.



The exclamation point within an equilateral triangle is intended to alert the user to the presence of important operating and maintenance (servicing) instructions in the literature accompanying the product.

Warning!

- To reduce the risk of fire or electric shock, do not expose this unit to rain or moisture.
- Do not open the unit - risk of electric shock inside.
- This apparatus must be earthed.
- Use a three wire grounding type line chord like the one supplied with the product.
- Be advised that different operating voltages require the use of different types of line cord and attachment plugs. If in doubt please contact your TC distributor.
- Check the voltage in your area and use the correct type. See table below:

Voltage	Line plug according to standard.
110-125V	UL817 and CSA C22.2 no 42.
220-230V	CEE 7 page VII, SR section 107-2-D1/IEC 83 page C4.
240V	BS 1363 of 1984. Specification for 13A fused plugs and switched and un-switched socket outlets.

- Mount in a well ventilated rack with a little space above and below.
- This equipment should be installed near the socket outlet and disconnection of the device should be easily accessible.
- Do not install near heat source, such as radiators, heat registers, stoves or other apparatus. (including amplifiers) that produce heat.
- Do not rely solely on the front screws when mounted in touring rack. Support the back as well.
- Clean only with a damp cloth.
- Do not defeat the safety purpose of a polarized or grounding type plug. A polarized plug has two blades with one wider than the other. A grounding type plug has two blades/prongs and a third grounding prong. The wide blade or the third prong are provided for your safety. When the provided plug does not fit into your outlet, consult an electrician for replacement of the obsolete outlet.
- Protect the power cord from being walked on or pinched particularly at plugs convenience receptacles, and the point where they exit from the apparatus.
- Only use attachments/accessories specified by the manufacturer.
- Unplug this apparatus during lightning storms or when unused for long periods of time.

IMPORTANT SAFETY INSTRUCTIONS

Service

There are no user-serviceable parts inside. All service must be performed by qualified personnel. Servicing is required when:

- the unit has been damaged in any way, such as when the power-supply cord or plug is damaged.
- the unit has been exposed to rain or moisture, or liquid has been spilled into the unit.
- objects have fallen into the unit.
- the unit does not work properly.
- the unit has been dropped.

This equipment has been tested and found to comply with the limits for a Class B Digital device, pursuant to part 15 of the FCC rules.

These limits are designed to provide reasonable protection against harmful interference in a residential installations.

This equipment generates, uses and can radiate radio frequency energy and, if not installed and used in accordance with the instructions, may cause harmful interference to radio communications. However, there is no guarantee that interference will not occur in a particular installation.

If this equipment does cause harmful interference to radio or television reception, which can be determined by turning the equipment off and on, the user is encouraged to try to correct the interference by one or more of the following measures:

- Reorient or relocate the receiving antenna.
- Increase the separation between the equipment and receiver.
- Connect the equipment into an outlet on a circuit different from that to which the receiver is connected.
- Consult the dealer or an experienced radio/TV technician for help.

The user may find the following booklet, prepared by the Federal Communications Commission, helpful:

"How to Identify and Resolve Radio/TV Interference Problems."

This booklet is available from the US. Government Printing Office, Washington, DC 20402, Stock No. 004-000-0034-4.

Caution:

You are cautioned that any change or modifications not expressly approved in this manual could void your authority to operate this equipment.

For the customers in Canada:

This Class B Digital apparatus meets all requirements of the Canadian Interference-Causing Equipment Regulations. Cet appareil numérique de la classe B respecte toutes les exigences du Règlement sur le matériel brouilleur du Canada.

Certificate Of Conformity

TC Electronic A/S, Sindalsvej 34, 8240 Risskov, Denmark, hereby declares on own responsibility that following product:

D•TWO - MULTITAP RHYTHM DELAY

- that is covered by this certificate and marked with CE-label conforms with following standards:

EN 60065 (IEC 60065)	Safety requirements for mains operated electronic and related apparatus for household and similar general use
EN 55103-1	Product family standard for audio, video, audio-visual and entertainment lighting control apparatus for professional use. Part 1: Emission.
EN 55103-2	Product family standard for audio, video, audio-visual and entertainment lighting control apparatus for professional use. Part 2: Immunity.

With reference to regulations in following directives:
73/23/EEC, 89/336/EEC

Issued in Risskov, November 1999

Anders Fauerskov
Chief Executive Officer

APPENDIX - MIDI IMPLEMENTATION CHART

MULTI-TAP RHYTHM DELAY D•TWO - NOVEMBER - 1999

Function		Transmitted	Recognized	Remarks
Basic Channel	Default	1	1	
	Changed	1-16	1-16	
Mode	Default			
	Messages	X	X	
	Altered			
Note Number		X	X	
	True Voice	X	X	
Velocity	Note ON	X	X	
	Note OFF	X	X	
After Touch	Key's	X	X	
	Ch's	X	X	
Pitch Bend		X	X	
Control Change		from 16-28	from 16-28	
		48-99	48-99	
Prog Change		O	O	
System Excl. Common		O	O	
	:Song Pos	X	X	
	:Song Sel	X	X	
	:Tune	X	X	
System real time	:Clock	X	O	
	:Commands	X	X	
Aux Messages	:Local ON/OFF	X	X	
	:All Notes OFF	X	X	
	:Active Sense	X	X	
	:Reset	X	X	

O: YES

X: NO

Mode 1: OMNI ON, POLY

Mode 3: OMNI OFF, POLY

Mode 2: OMNI ON, MONO

Mode 4: OMNI OFF, MONO

APPENDIX - TECHNICAL SPECIFICATIONS

Digital Inputs and Outputs

Connectors: RCA Phono (S/PDIF)
Formats: S/PDIF (24 bit), EIAJ CP-340, IEC 958
Output Dither: HPF/TPDF dither 24/20/16/8 bit
Sample Rates: 44.1 kHz, 48 kHz
Processing Delay: 0.1 ms @ 48 kHz
Frequency Response DIO: DC to 23.9 kHz \pm 0.01 dB @ 48 kHz

Analog Inputs

Connectors: 1/4" phone jack, balanced
Impedance, Bal / Unbal: 21 kOhm / 13 kOhm
Max. Input Level: +24 dBu
Min. Input Level for 0 dBFS: 0 dBu
Sensitivity: @ 12 dB headroom: -12 dBu to +12 dBu
A to D Conversion: 24 bit, 128 x oversampling bitstream
A to D Delay: 0.65 ms / 0.70 ms @ 48 kHz / 44.1 kHz
Dynamic Range: 100 dB typ, 20 Hz - 20 kHz
THD: typ < 92 dB (0.0025 %) @ 1 kHz
Frequency Response: +0/-0.1 dB @ 48 kHz, 20 Hz to 20 kHz
Crosstalk: <-95 dB, 20 Hz to 20 kHz

Analog Outputs

Connectors: 1/4" phone jack, balanced
Impedance Balanced / Unbalanced: 40 Ohm
Max. Output Level: +20 dBu (balanced)
Output Ranges: Balanced: 20/14/8/2 dBu
Unbalanced: 14/8/2 dBu
D to A Conversion: 24 bit, 128 x oversampling bitstream
D to A Delay: 0.63 ms / 0.68 ms @ 48 kHz / 44.1 kHz
Dynamic Range: 104 dB typ, 20 Hz to 20 kHz
THD: typ <-94 dB (0.002 %) @ 1 kHz, +20 dBu Output
Frequency Response: +0/-0.5 dB @ 48 kHz, 20 Hz to 20 kHz
Crosstalk: <-100 dB, 20 Hz to 20 kHz

EMC

Complies with: EN 55103-1 and EN 55103-2
FCC part 15, Class B, CISPR 22, Class B

Safety

Certified to: IEC 65, EN 60065, UL6500 and CSA E65

Environment

Operating Temperature: 32° F to 122° F (0° C to 50° C)
Storage Temperature: -22° F to 167° F (-30° C to 70° C)
Humidity: Max. 90 % non-condensing

Control Interface

MIDI: In/Out/Thru: 5 Pin DIN
Pedal: 1/4" phone jack

General

Finish: Anodized aluminum front
Plated and painted steel chassis

Display

Dimensions: 23 character / 280 icon STN-LCD display
Weight: 19" x 1.75" x 8.2" (483 x 44 x 195 mm)
4.1 lb. (1.85 kg)
Mains Voltage: 100 to 240 VAC, 50 to 60 Hz (auto-select)
Power Consumption: <15 W
Warranty Parts and labor: 1 year

PRESET LIST

The D•TWO holds 50 factory presets. The preset names and locations are listed below.
In addition you can store up to 100 of your own presets in the User bank.

- | | | | |
|----|-----------------------|----|----------------------|
| 1 | D-Two Delay | 26 | Dark and Long |
| 2 | Straight 2290 Delay | 27 | 1/16th Stab |
| 3 | Dynamic Delay | 28 | Rightfield |
| 4 | Dynamite Pink Punk | 29 | New Jock Swing |
| 5 | Chorused Delay | 30 | Rhythm Engine |
| 6 | Big E Slapback | 31 | groovey Breaker |
| 7 | Phase reversed Echo | 32 | Heavy Accent |
| 8 | Reversed Slap | 33 | Syncopated Beatbox |
| 9 | Tape Echo | 34 | Short Shuffled 1/16 |
| 10 | Low Cut 1/8th Notes | 35 | Shuffle Hat |
| 11 | Mono Radio | 36 | Marmite on the Keys |
| 12 | Degraded Panning | 37 | ECHOecho..echo...CHO |
| 13 | Shuffled 1/16th | 38 | Reversed Cunks |
| 14 | Left / Right Slapback | 39 | Tow Bar 1/8 Pattern |
| 15 | GTR Bitch-Slapped | 40 | Last Man Standing |
| 16 | GTR Lead The Way | 41 | ---> The End (: |
| 17 | My Old Echoplex | 42 | Jungle Fever |
| 18 | Double Tap Flange | 43 | Dark Triplets |
| 19 | Slapback Flanger | 44 | Fast Triplets |
| 20 | Fat Flanger | 45 | Moving Hat |
| 21 | The Stereo Chorus | 46 | D-two In The House |
| 22 | Ambient Chorus | 47 | Shuffel Your Feet |
| 23 | Fat Guitar | 48 | Stabbed In The Back |
| 24 | Giant mockup in 3/4 | 49 | Flying Stabs |
| 25 | Beauty in The Beats | 50 | Reversed Semi Bar |