

# 4K2HD Mini-Converter

## 4K to HD



## Installation and Operation Guide

Version 1.15  
Published April 1, 2019



# Notices

---

## Trademarks

---

AJA® and Because it matters.® are registered trademarks of AJA Video Systems, Inc. for use with most AJA products. AJA™ is a trademark of AJA Video Systems, Inc. for use with recorder, router, software and camera products. Because it matters.™ is a trademark of AJA Video Systems, Inc. for use with camera products.

CION®, Corvid Ultra®, Io®, Ki Pro®, KONA®, KUMO®, ROI® and T-Tap® are registered trademarks of AJA Video Systems, Inc.

AJA Control Room™, KiStor™, Science of the Beautiful™, TruScale™, TruZoom™, V2Analog™ and V2Digital™ are trademarks of AJA Video Systems, Inc.

AirPort, Apple, Apple logo, AppleShare, AppleTalk, FireWire, iPod, iPod touch, Mac, Macintosh and ProRes, are registered trademarks of Apple Inc. Final Cut Pro, QuickTime and QuickTime logo are trademarks of Apple Inc.

Avid, Avid DNxHD and Media Composer are registered trademarks of Avid Technology, Inc.

Adobe is a registered trademark of Adobe Systems Incorporated in the United States and/or other countries.

HDMI, the HDMI logo and High-Definition Multimedia Interface are trademarks or registered trademarks of HDMI Licensing, LLC.

DVI is a registered trademark of DDWG.

TASCAM is a registered trademark of TEAC Corporation.

Dolby and the double-D Dolby logo are registered trademarks of Dolby Laboratories Licensing Corporation.

openGear® Ross, ROSS, ROSS®, and MLE are registered trademarks of Ross Video.

DashBoard Control System™ is a trademark of Ross Video.

All other trademarks are the property of their respective holders.

## Copyright

---

Copyright © 2019 AJA Video Systems, Inc. All rights reserved. All information in this manual is subject to change without notice. No part of the document may be reproduced or transmitted in any form, or by any means, electronic or mechanical, including photocopying or recording, without the express written permission of AJA Video Systems, Inc.

## Contacting AJA Support

---

When calling for support, have all information at hand prior to calling. To contact AJA for sales or support, use any of the following methods:

Telephone	+1.530.271.3190
FAX	+1.530.271.3140
Web	<a href="https://www.aja.com">https://www.aja.com</a>
Support Email	<a href="mailto:support@aja.com">support@aja.com</a>
Sales Email	<a href="mailto:sales@aja.com">sales@aja.com</a>

# Contents

---

- Notices . . . . . 2
  - Trademarks . . . . . 2
  - Copyright . . . . . 2
  - Contacting AJA Support . . . . . 2
  
- Chapter 1 – Introduction . . . . . 4
  - Overview . . . . . 4
    - 4K2HD Operating Modes . . . . . 4
    - Default Operation . . . . . 5
    - Video Output . . . . . 5
    - Mini-Config Control . . . . . 5
  - Features . . . . . 6
  - Block Diagram . . . . . 7
  - I/O Connections . . . . . 7
  - Installation . . . . . 8
  
- Chapter 2 – Operation . . . . . 9
  - USB Control and Setup—Using AJA Mini-Config . . . . . 9
    - Acquiring AJA Mini-Config . . . . . 9
    - Installing AJA Mini-Config . . . . . 9
    - Running AJA Mini-Config . . . . . 11
    - Operating AJA Mini-Config . . . . . 12
    - Tabbed Screens . . . . . 13
  - Input Screen . . . . . 14
  - Output Screen . . . . . 15
    - Output Mode . . . . . 16
    - SDI Out . . . . . 16
  - HDMI Screen . . . . . 17
  - Audio Screen . . . . . 18
  - Update Screen . . . . . 19
    - Software Update Procedure . . . . . 19
  - Info Screen . . . . . 20
  
- Appendix A – Specifications . . . . . 21
  
- Appendix B – Safety and Compliance . . . . . 24
  
- Warranty Information . . . . . 31
  - Limited Warranty . . . . . 31
  
- Index . . . . . 32

# Chapter 1 – Introduction

---



## Overview

---

AJA's 4K2HD downconverts professional SDI 4K/UltraHD signals to HD resolution using AJA's high-quality scaling for cost-effective monitoring and conversion. 4K2HD's HD-SDI and HDMI outputs are both live all the time, producing fantastic-looking HD images for on set monitoring or direct-to-air broadcast. 4K2HD supports high frame rate (HFR) 4K/UltraHD inputs at 50/59.94/60fps and converts the 2K/HD output to 50/59.94/60fps for accurate viewing. 4K2HD's configuration options can extract a 2K/HD resolution image from the 4K/UltraHD input to provide a one-to-one pixel image for 4K/UltraHD focus checks on 2K/HD displays. Configuration can be set remotely via AJA Mini-Config software control over USB.

## 4K2HD Operating Modes

---

4K2HD has three working modes: 4K Down-Conversion mode, Non-4K mode, and Center Cut mode. The first two modes are selected automatically depending on the input video. These modes can also be manually set using the Mini-Config application.

- **4K Down Conversion mode:** If the format of the input video is detected as 4K or UltraHD format, or the unit is configured by Mini-Config, 4K/UltraHD input video is down-scaled to 2K/HD video and then output on both the HDMI and the SDI outputs.
- **Non-4K mode:** If the format of input video is detected as non-4K video source, e.g. 720p60, or the unit is configured by Mini-Config, 4K2HD will not try to make 4K/UltraHD video from four video inputs. Instead, it will output video to HDMI/SDI from the selected SDI input.
- **Center Cut mode:** 4K2HD will be in Center Cut mode if the input video is 4K/UltraHD format, and the mode has been enabled through Mini-Config. In this mode the 2K/HD center of 4K/UltraHD input video will be output to the HDMI and SDI outputs. No down-scaling occurs, and the output format is either 1920x1080 or 2048x1080 (depending the input source and the 2K cropping configuration).

## Default Operation

---

The 4K2HD auto configures to the connected inputs.

The auto-configure function identifies the connected inputs and generates the default outputs for the given input. Default operation can be overridden and set manually using AJA's Mini-Config application.

*NOTE: Signal conversion requires the presence of a valid SDI video signal on the SDI IN 1 BNC.*

For single SD or HD inputs, BNC input 1 is the default input. For dual-link 1.5Gb HD inputs, and 4K/UltraHD dual-stream 3Gb SDI inputs, inputs 1 and 2 are default. Where applicable, both level A and B 3Gb inputs are auto-detected and supported.

When connecting the 4K2HD with multiple SDI inputs in the auto-configure mode (default), as the user connects the first HD-SDI to input 1, the unit will output that input as a full screen HD. As soon as the second input is connected, the unit will know that either QuadHD or 4K x 2160 is present and the display will change to show the two connected quadrants in the upper left and upper right of the output. The remaining two quadrants will be displayed as they are connected.

It is possible to use two dual-stream 3G inputs to make 3840 or 4K video. In this case SDI1 and SDI2 are assumed to be the inputs: SDI1 linkA makes the top left quadrant, SDI1 linkB makes the top right quadrant, SDI2 linkA makes the lower left quadrant, and SDI2 linkB makes the lower right quadrant. To use this mode change the Video Source Selection to '2 X SDI 4K'.

## Video Output

---

4K2HD has two output connectors, HDMI and SDI, that are both active simultaneously.

For 4096x2160 inputs, the 4K2HD will output 2048x1080 if 2K crop option is turned off (through Mini-Config), otherwise 4096x2160 inputs will be scaled to 2048x1080, then cropped to 1920x1080. 4K2HD will not scale 4096 to 1920 pixels.

The HDMI and SDI output connectors will generally be the same video, with the exception of non-4K PsF video input.

SDI passthrough is enabled by default if the input video is 2K/HD PsF. In this case, SDI output is PsF format, and HDMI output is progressive format. The HDMI output is delayed one frame, compared to the SDI output. The SDI passthrough can be disabled by Mini-Config. If disabled, the SDI output will be progressive format, the same as HDMI output, with no frame delay.

The HDMI and SDI outputs are turned off when no active SDI Input signal is detected, allowing connected displays to go on Standby/Sleep mode.

## HDMI and SDI Output Control Differences

---

Some video output control options are only applicable to HDMI output, such as color range, sample structure or HDMI/DVI standard. Some options are only applicable to SDI output, such as Level B control, or PsF passthrough. And some output control options are applied to both, such as Center Cut.

## Mini-Config Control

---

Configuration set via Mini-Config is stored in the 4K2HD unit through subsequent power cycles.

## Mini-Config Control Functions

---

### Input Video Selections

---

- Video Source (Auto, 4xSDI 4K, 2xSDI 4K, 2xSDI HD-DL, SDI 1-4)
- Color Space (Auto, 422 YCbCr, 444 RGB, or 444 YCbCr)
- RGB Range (SMPTE or Full color range).
- Bit Depth (Auto, 8-bit, or 10-bit)
- Mapping (Quadrant or 2SI)
- Video Format (Auto, Progressive, Interlaced, or PsF).
- 3G-B Mode (Auto, Dual Link, 2xHD, 1 x HD DS1, 1 x HD DS2)

### Output Video Selections

---

- 4K Convert (Downconvert, Center Cut)
- 2K Crop (On or Off)
- SDI Out (Passthrough or Processed)
- Edge Filtering (On or Off)
- 1080p to 1080i interlacer

### HDMI Output

---

- Color Space (Auto, 4:2:2 YCbCr, 4:4:4 RGB, 4:4:4 YCbCr)
- Bit Depth (Auto, 8-bit, or 10-bit)
- RGB Range (Auto, SMPTE or Full)
- Color Dithering (Off or On)
- HDMI/DVI (Auto, HDMI, or DVI)

### Audio

---

- Input Source (Ch 1-8 or Ch 9-16 from any SDI input)
- HDMI Channel Count (Auto, 2, 8)
- Audio Offset In Frames

## Features

---

- 4K (4096x2160) and UltraHD (3840x2160) support (see ["Appendix A Specifications" on page 21](#) for a complete list of supported inputs)
- Down-conversion to support 4K on HD-SDI and HDMI devices
- Simultaneous HD-SDI and HDMI output
- True 4K downscaled and cropped for HD output
- Center cut of original 4K frame supported for focus checks
- Supports 4K/UltraHD 50/60fps high frame rate input formats
- Configurable via AJA Mini-Config software for Mac and PC
- DWP-U-R1 Power Supply Included
- 5-year warranty

*NOTE: 3D is not supported in this converter.*

*NOTE: 720p 4:4:4 formats are not supported in this release.*

# Block Diagram

Figure 1. 4K2HD Converter, Simplified Block Diagram

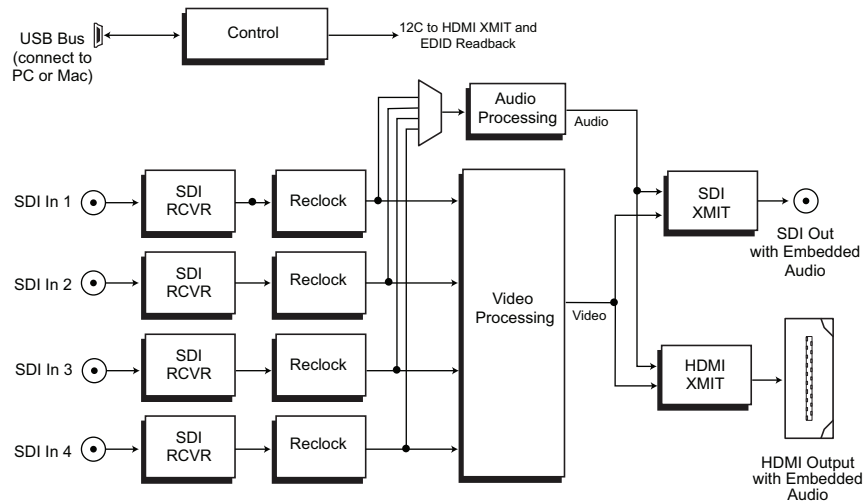

# I/O Connections

Figure 2. 4K2HD Converter Connection



NOTE: LEDs adjacent to each SDI input connector indicate by color the detected signal type. Green is SD-SDI, red is HD-SDI, and amber/orange is 3G-SDI.



# Installation

---

Typically, 4K2HD installation consists of the following steps:

1. Ensure the 4K2HD is disconnected from power.
2. Connect video equipment to the converter BNCs and HDMI connector.
3. Apply power to the converter (AJA power supply included).
4. The 4K2HD will now run using the default factory settings. If you wish to alter the factory settings, you'll need to:
  - Install the AJA Mini-Config software on your computer.
  - Attach the 4K2HD via USB.
  - Make your changes using Mini-Config setup screens.

See "[USB Control and Setup—Using AJA Mini-Config](#)" on page 9 for more information.



# Chapter 2 – Operation

---

## USB Control and Setup—Using AJA Mini-Config

---

Your AJA Mini-Converter can be used right out of the box for some applications since it is designed to recognize inputs and perform standard actions automatically by default. However, to use its full capability, you must use AJA's Mini-Config software application for PCs and Macs. This same application can be used to update to new Mini-Converter software released by AJA.

### Acquiring AJA Mini-Config

---

AJA's Mini-Config application is available for download from the AJA website.

To download the latest AJA Mini-Config package, which includes the AJA Mini-Config application, Mini-Converter firmware, and documentation, go to:

<https://www.aja.com/en/products/mini-converters/mini-config-software>

Select either the Windows or Mac icon to download the desired version.

### Mini-Converter Documentation

---

Included with the AJA Mini-Config package is a complete set of documentation for all Mini-Converters supported by AJA Mini-Config. A .PDF of the *Installation and Operation Guide* for the currently connected Mini-Converter can be accessed from the AJA Mini-Config UI via the **Help/Manual** drop-down menu.

Documentation for all AJA Mini-Converters that use AJA Mini-Config can also be accessed directly in the AJA Mini-Config download package Documentation folder, and via the Documentation icon available on the Mac installer.

Documentation (and firmware) included with the AJA Mini-Config application are the versions available at the time of distribution. However, Mini-Converter software, firmware and documentation are updated regularly, so newer versions may exist.

To download the latest documentation for an individual Mini-Converter, go to:

<https://www.aja.com/en/category/mini-converters>

and navigate to the Support webpage of that Mini-Converter.

## Installing AJA Mini-Config

---

### PC Installation

---

To install AJA Mini-Config on a Windows PC:

1. Download the application from the AJA website (select the Windows icon on the AJA Mini-Config Support webpage).
2. Open the AJA\_MiniConfig.zip file
3. Double-click on the MiniInstaller.msi file.
4. A Setup Wizard will guide you through the installation.

Figure 3. AJA Mini-Config PC Setup Wizard

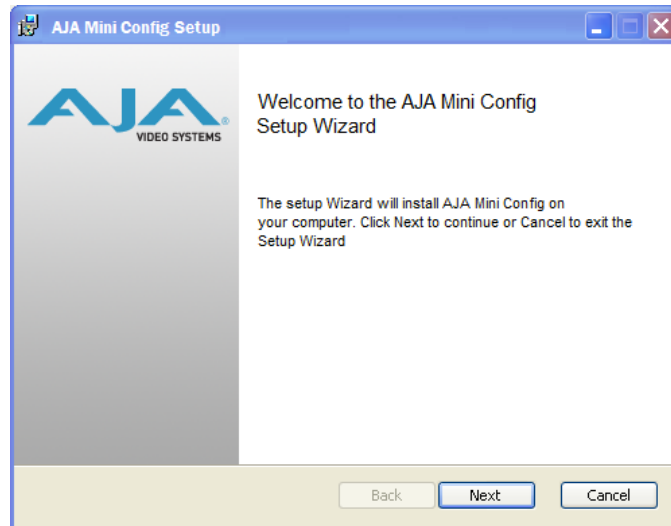

5. Click Next to begin. Answer the questions in the subsequent dialogues. When finished, an AJA Mini-Config shortcut will be installed on the desktop, and you will be able to locate the AJA Mini-Config application in the AJA folder in the Programs listing.

*NOTE: If the AJA Mini-Config application already exists on the PC, a different Setup Wizard appears.*

Figure 4. AJA Mini-Config Setup Wizard, Reinstallation

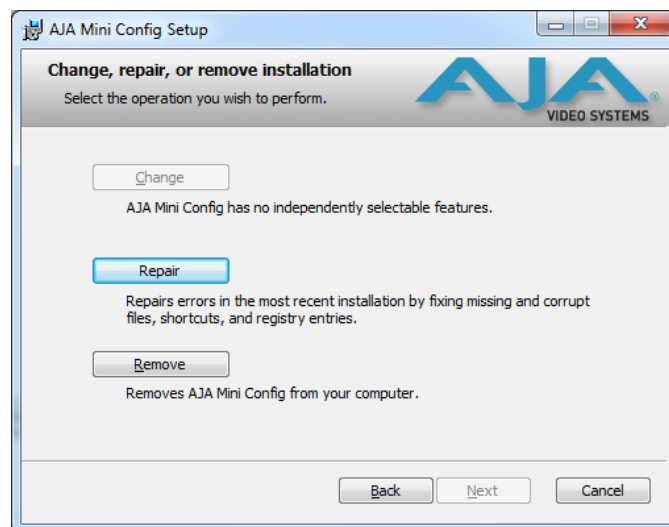

With this screen you can **Repair** (reinstall) or **Remove** (uninstall) AJA Mini-Config on the PC.

## Mac Installation

To install the application on a Mac:

*NOTE: Macintosh computers must be Intel-based (G5, G4 and earlier models will not work with AJA Mini-Config).*

1. Download the application from the AJA website (select the Apple icon on the AJA Mini-Config Support webpage).
2. Open the AJA\_MiniConfig folder.
3. Double-click on the AJAMiniConfig.dmg file.

4. Answer the prompt and a utility program will be launched.

Figure 5. AJA Mini-Config Mac Installer

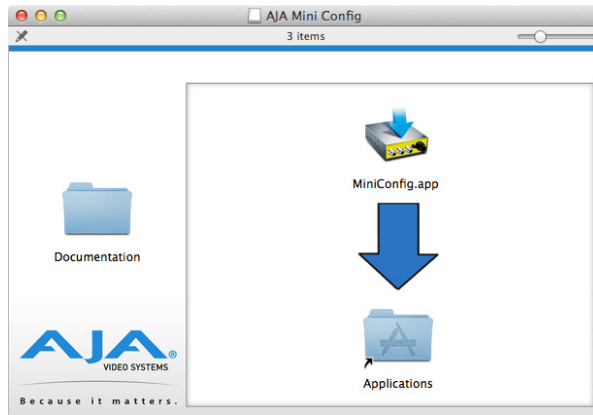

5. To complete the installation drag the "MiniConfig.app" icon to the Applications folder.

## Running AJA Mini-Config

Connect the Mini-Converter to the PC or Mac via the supplied USB cable. Connect the external power supply (supplied) to the Mini-Converter.

### PC Startup

To run AJA Mini-Config on a PC, double-click on the AJA Mini-Config icon on your desktop, or open the AJA folder in the program list and click on the AJA Mini-Config application located inside the AJA Mini-Config folder.

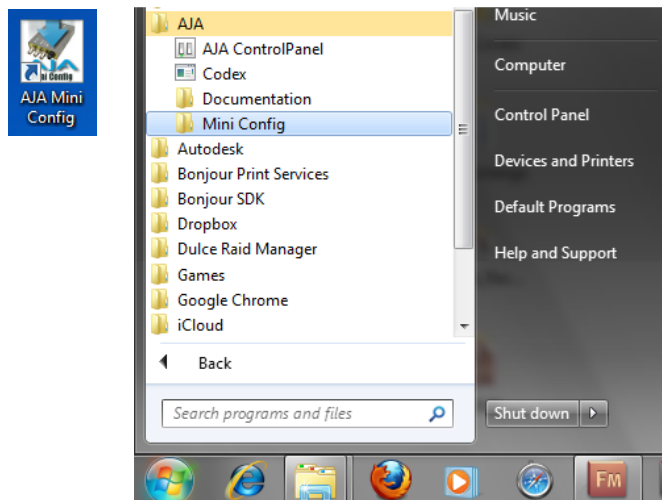

### Mac Startup

To run AJA Mini-Config on a Mac, open the Applications folder and locate the AJA Mini-Config application. Double-click the application to launch it.

### Saving Setups

A **File** drop down menu on the AJA Mini-Config application bar allows you to save the current state of the Mini-Converter to a preset file for later recall.

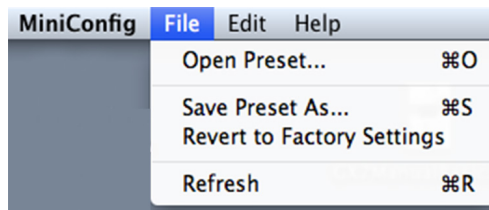

Using this feature you can set up the converter for different applications, storing each configuration (**Save Preset As...**) with a unique name for easy recall (**Open Preset...**).

A **Revert to Factory Settings** menu item similarly allows you to change the settings back to AJA's factory defaults.

## Operating AJA Mini-Config

---

The AJA Mini-Config application provides a graphic interface for viewing settings and updating software. It consists of an information area at the top that shows the available Mini-Converters attached to the computer via USB, with a graphical rendering of the selected Mini-Converter showing all the connectors and their current state.

Colored text next to the connectors indicates the signal type and what the Mini-Converter is doing:

- Blue text indicates the values automatically selected
- Black text indicates values that you have manually selected
- Red text indicates the Mini-Converter is not detecting a signal, or cannot operate with the current user settings.

*NOTE: Even if no output device is detected, the SDI connector text still shows the signal it is outputting.*

*NOTE: Configuration settings in red will change based on the attached output device as well as input signals. For improved accuracy and reliability, you should configure the Mini-Converter only when the target output device is attached and input signals are supplied at the inputs.*

Screens are virtually the same on both PC and Mac, with subtle differences that reflect the general look of the platform environment.

Figure 6. Example AJA Mini-Config Screen

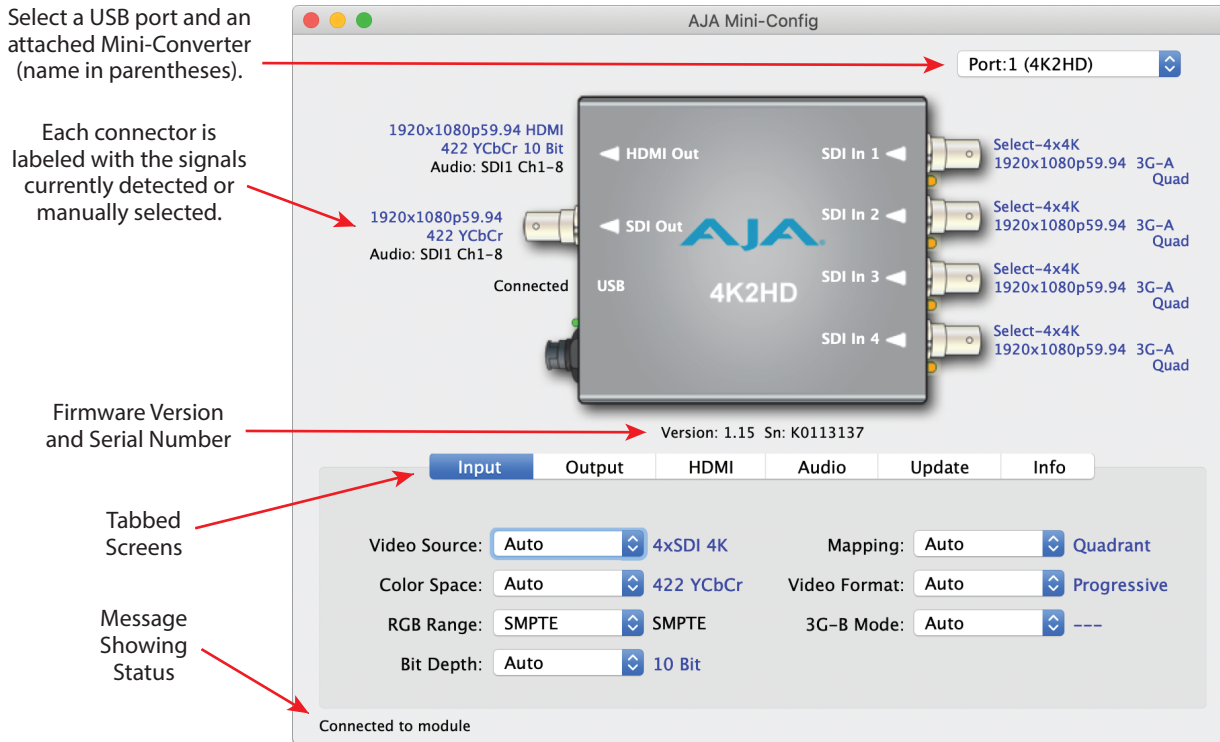

**NOTE:** The LEDs adjacent to each SDI connector indicate by color the detected signal type. Off is no signal, Green is SD-SDI, red is HD-SDI, and amber is 3G-SDI.

Selecting a Mini-Converter with the pulldown menu causes this application to connect to the selected converter. The graphic of Mini-Converter and text below it provides:

- Type of converter
- Firmware version
- Serial number of the unit.

A status field at the bottom of the screen shows if your application is connected and communicating with the Mini-Converter.

When configuring the Mini-Converter, select it from the top pulldown, view the current settings and change any values. Making a change communicates that new value to the Mini-Converter's non-volatile memory.

## Tabbed Screens

The Tabs delineate control screens with groups of controls for each type of task to be performed. The controls for the actual configuration parameters are specific to each Mini-Converter type. When you Click on any of the tab buttons, the pane below the tabs will change to match your tab selection. Any changes you make are immediately applied and will be saved, overwriting previous settings.

# Input Screen

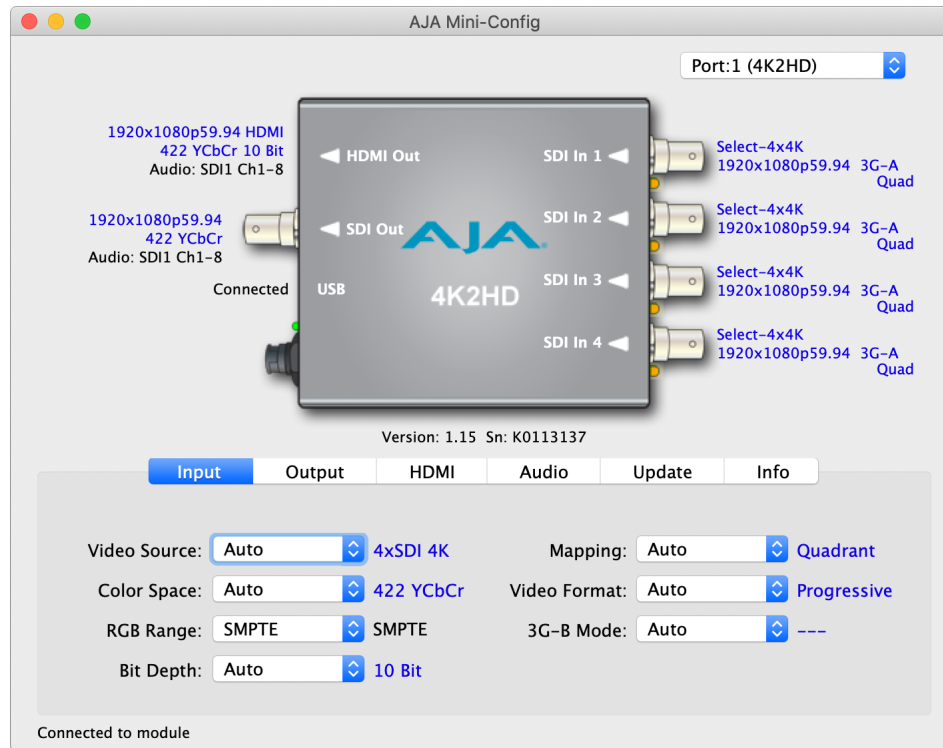

Click on the Input tab to view and make changes to the converter's input settings.

## Video Source

Selects the input video format. Choose from the following:

- Auto - automatically selects the format based on the input video parameters.
- 4xSDI 4K
- 2xSDI 4K - (3G-B Dual Stream input required)
- 2xSDI HD-DL - (2 wire SMPTE 372)
- SDI 1, SDI 2, SDI 3, or SDI 4

**NOTE:** One of the 4 incoming quadrants of 4K video can be shown full screen on the HDMI/SDI outputs. This is accomplished by selecting one of the 4 SDI inputs, but requires that all 4 SDI inputs are connected.

## Color Space

Selects the Input Video Color Space. Choose Auto, 422 YCbCr, 444 RGB, or 444 YCbCr. Choosing "Auto" will automatically select color mode based on the input video parameters and the payload ID.

## RGB Range

Selects the Input Video Color Range. Choose SMPTE (default) or Full color range. There is no auto detection for color range.

## Bit Depth

Selects the input video bit depth. Choose Auto, 8-bit, 10-bit, or 12-bit. Choosing "Auto" automatically selects the bit depth based on the input video parameters and the payload ID.

## Mapping

Select the 4K/UltraHD mapping format:

- Auto (default) -automatically selects the mapping based on the input video.
- 2SI - Two Sample Interleave
- Quadrant - Square Division

## Video Format

Selects the Input Video Format. Choose from Auto, Progressive, Interlaced, or PsF (progressive segmented frame). Choosing "Auto" automatically selects the format based on the input video parameters and the payload ID.

## 3G-B Mode

Selects the 3G level B Video Mode. Choose from the following:

- Auto - automatically selects the format based on the input video parameters.
- Dual Link - select this when the input is Dual Link., your 3G signal is carrying 444 information, or the input is 1080p50/59.94.
- 2xHD - Dual Stream - each Data Stream is an independent source.
- 1 x HD DS1 - use only Data Stream 1 as a single video.
- 1 x HD DS2 - use only Data Stream 2 as a single video.

# Output Screen

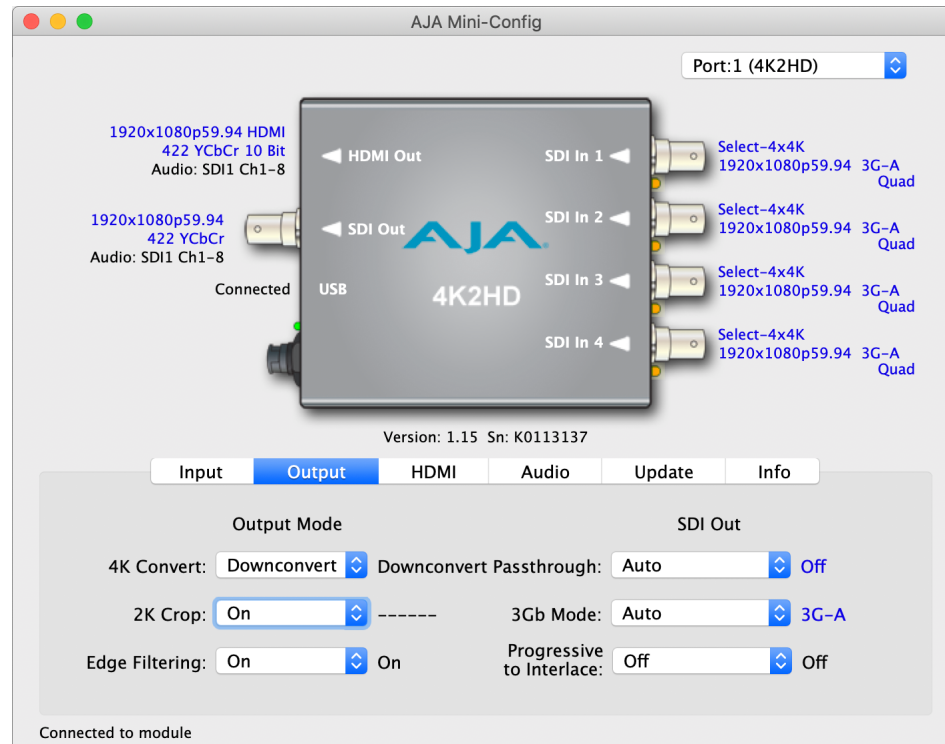

Click on the Output tab to view and make changes to the 4K2HD Output settings. These settings can affect both the HDMI and SDI outputs.

The HDMI and SDI outputs are turned off when no active SDI Input signal is detected, allowing connected displays to go on Standby/Sleep mode.



## Output Mode

---

### 4K Convert

---

- Downconvert - Downconverts incoming 4K signal to HD (default setting).
- Center Cut - Selects the center portion of the incoming 4K signal for display. No down-scaling occurs, and the output format is either 1920x1080 or 2048x1080 (depending the input source and the 2K Crop setting).

### 2K Crop

---

Choose On or Off. Provides the option of center cutting 2Kx1080 video signals to make 1920x1080, or center cutting a 4Kx2160 signal to make 1920x1080. Default is On.

### Edge Filtering

---

Choose On or Off. You can disable edge filtering with this control. This is useful if you are stitching together multiple images of 4K2HD outputs. An example is using four 4K2HD's to view UHD-2 or 8K on a UltraHD/4K or HD monitor. Each 4K2HD downconverts one quarter of the 8K image. Disabling edge filtering can eliminate the center vertical and horizontal lines that would occur between the quadrants in that situation. Default setting is On.

## SDI Out

---

### Passthrough

---

Choose Auto, Off, or On (default is Auto). This setting can be used with HD or 2K psf format input signals. When On, psf format will passthrough to the SDI output instead of the converted, progressive format signal.

### 3Gb Mode

---

Choose Auto, 3G-A, or 3G-B (default is Auto).

### Progressive to Interlace Enable

---

Progressive to Interlace Enable. Choose Off or On. When On, a 4K/UHD progressive input will be output as a 1920x1080 interlace signal when possible.

More specifically, when Progressive to Interlace is enabled, the 4K2HD converts 4096x2160 or 3840x2160 progressive signals to a 1920x1080 interlace signal. Crop is automatically applied if the input signal is 4K.

This conversion is functional for the 4K and UHD input formats listed below:

Input	Output
3840x2160p25 3840x2160p50 4096x2160p25 4096x2160p50	1920x1080i25
3840x2160p29.97 3840x2160p59.94 4096x2160p29.97 4096x2160p59.94	1920x1080i29.97
3840x2160p30 3840x2160p60 4096x2160p30 4096x2160p60	1920x1080i30

# HDMI Screen

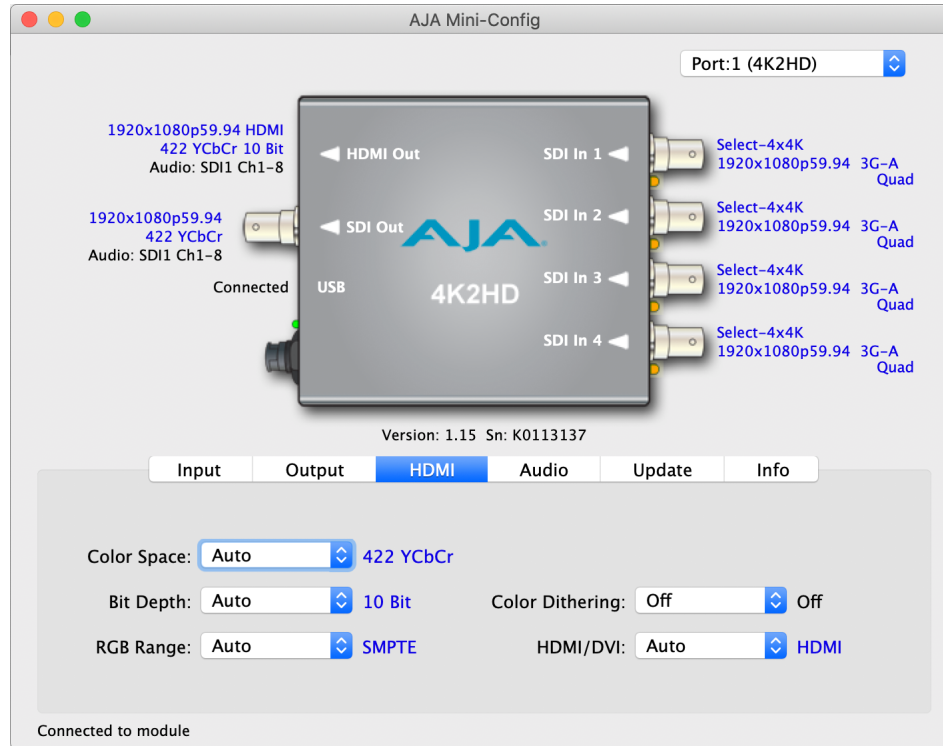

Click on the HDMI tab to view and make changes to the 4K2HD HDMI output settings.

## Color Space

Selects the desired output video format. Choose from the following:

- Auto - selects the video format based on the input video and the attached device's capabilities (default setting).
- 4:2:2 YCbCr (cannot exceed 10-bit depth)
- 4:4:4 RGB
- 4:4:4 YCbCr

## Bit Depth

Choose from Auto, 8-bit, or 10-bit (see limitations above). Choosing "Auto" automatically selects the bit depth based on the input video and the attached device's capabilities.

## RGB Range

Choose Auto, SMPTE or Full. Choosing "Auto" automatically selects the input color range setting.

## Color Dithering

Choose Off or On. Default is Off.

## HDMI/DVI

Choose Auto, HDMI, or DVI. When DVI is selected, any audio signals present are not passed. Choosing "Auto" automatically selects the output mode based on the attached device's capabilities. Default is Auto.

# Audio Screen

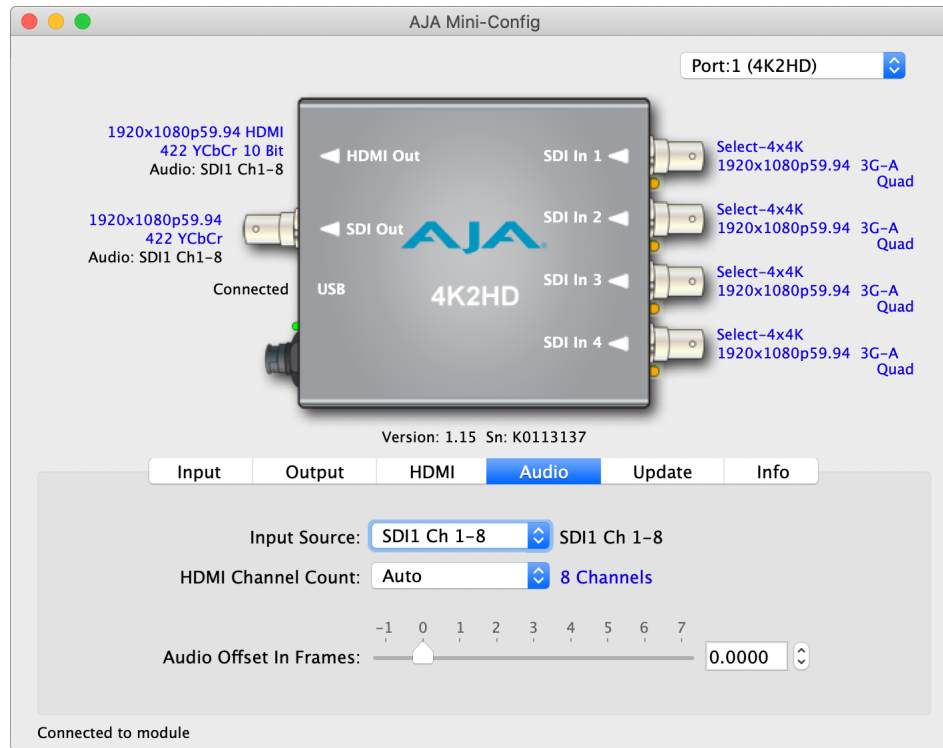

Click on the Audio tab to view and make changes to the 4K2HD audio settings.

## Input Source

Choose which embedded audio channels are routed to the HDMI output. Eight channels are routed at a time. You can choose Ch 1-8 or Ch 9-16 from any SDI input.

## HDMI Channel Count

Choose Auto, 2 of 8 channels or 8-channels embedded audio. Choosing "Auto" automatically selects the audio channels based on the attached device's capabilities.

The SDI output embedded audio always follows the selected HDMI Output source selection and is limited to 8 channels max.

## Audio Offset In Frames

Permits time shifting the embedded audio in relationship to the video (for example, to correct for lip sync problems), in 1/16 of a frame increments. Range is from -0.8125 video frame to +7.0 video frames. The actual time duration of delay will vary depending on the frame rate of the format being converted.

Default offset value is 0 frame to match the video delay path, resulting in time-aligned audio on the output. Positive offset delays the audio additional frames (relative to the video output), negative offset advances the audio relative to the video output.

# Update Screen

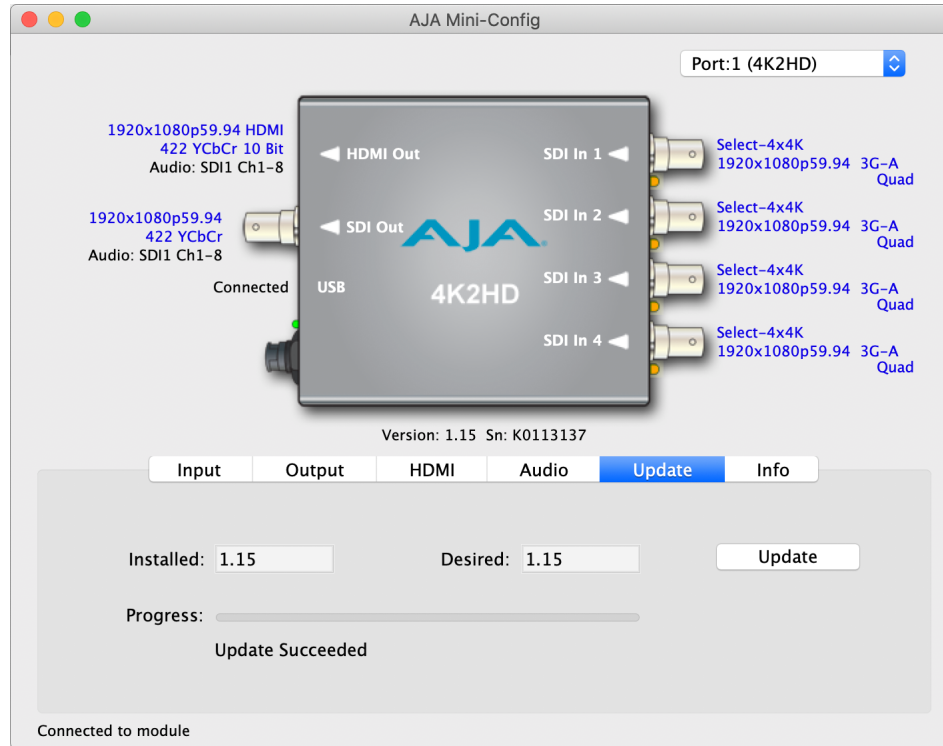

Use this Update screen to view the software version currently installed on the converter or install new software.

**NOTE:** When discussing Mini-Converters, “Firmware” is software that will be stored in the Mini-Converter’s non-volatile memory and used when it is powered up. This is something different than the Mini-Config application software. The version numbers shown in the Update screen refer only to the firmware.

## Installed

This field shows the version of the firmware currently installed inside the Mini-Converter.

## Desired

This field shows the version of firmware embedded in the Mini-Config application which you can install into the Mini-Converter by clicking the Update button.

## Update

This button initiates a software update operation loading the “Desired” version of firmware into the Mini-Converter’s non-volatile memory.

## Progress

This indicator bar shows the progress of firmware installation.

## Software Update Procedure

1. Check the AJA website for new Mini-Config software for your Mini-Converter. If new software is found, download it and uncompress the file archive (zip). Here is the URL to use when checking:

<http://www.aja.com/en/products/mini-converters/mini-config-software>

2. Connect the Mini-Converter to a Mac or PC via a USB port on the computer and run the new Mini-Config software just downloaded.
3. Click on the Update tab screen.
4. Check the Installed version level against the Desired version level. If the Desired is newer, then click the Update button to download the new firmware to the Mini-Converter; progress will be shown via the "Progress" thermometer bar.

## Info Screen

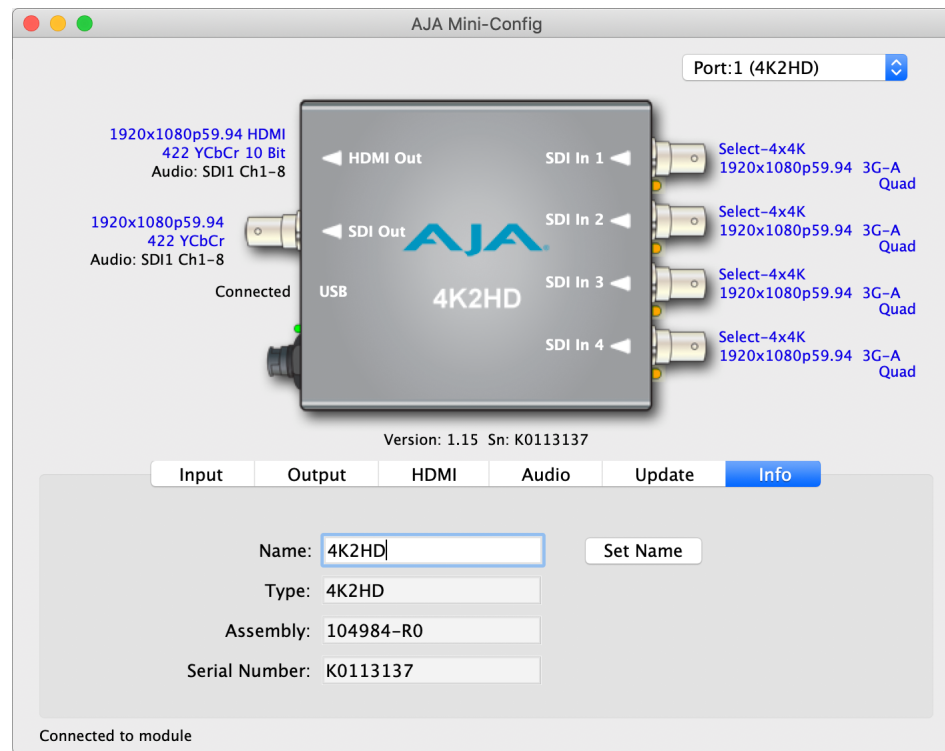

This screen provides basic information about the Mini-Converter. This information is useful when calling AJA Support for service or technical support.

### Name

This field allows you to give your Mini-Converter a name. This can be useful if you have several Mini-Converters attached to a Mac/PC via USB so you can distinguish between them easily (especially if they're the same model).

### Type

This is the factory set model name of the Mini-Converter (4K2HD).

### Assembly

This is the factory assembly number.

### Serial Number

This is the factory set unique serial number of your 4K2HD. If you ever call AJA Support for service, you may be asked for this number.

# Appendix A – Specifications

---

## 4K2HD Tech Specs

---

### Video Formats

---

- (4K) 4096 x 2160p
- (4K) 4096 x 2160PsF
- (UltraHD) 3840 x 2160p
- (Ultra HD) 3840 x 2160PsF
- (2K) 2048 x 1080p
- (2K) 2048 x 1080Psf
- (HD) 1920 x 1080p
- (HD) 1920 x 1080Psf
- (HD) 1920 x 1080i
- (HD) 1280 x 720p
- (SD) 720 x 576i
- (SD) 720 x 480i

### Video Input Digital

---

- 4x 3G-SDI BNC, SMPTE-259/292/372/424
- YCbCr 4:2:2/4:4:4
- RGB 4:4:4, SMPTE or Full level
- 8 or 10-bit
- Two Sample Interleave (2SI) or Square Division (Quadrant) source mapping
- 4x 3 Gb SDI (Level A or B-Dual Link)
  - (4K) 4096 x 2160p 23.98, 24, 25, 29.97, 30, 50, 59.94, 60
  - (4K) 4096 x 2160PsF\* 23.98, 24, 25, 29.97, 30
  - (UltraHD) 3840 x 2160p 23.98, 24, 25, 29.97, 30, 50, 59.94, 60
  - (Ultra HD) 3840 x 2160PsF\* 23.98, 24, 25, 29.97, 30
- 4x 1.5 Gb SDI
  - (4K) 4096 x 2160p 23.98, 24, 25, 29.97, 30
  - (4K) 4096 x 2160PsF 23.98, 24, 25, 29.97, 30
  - (UltraHD) 3840 x 2160p 23.98, 24, 25, 29.97, 30
  - (UltraHD) 3840 x 2160PsF 23.98, 24, 25, 29.97, 30
- 2x 3 Gb SDI (Level B-Dual Stream)
  - (4K) 4096 x 2160p 23.98, 24, 25, 29.97, 30
  - (4K) 4096 x 2160PsF 23.98, 24, 25, 29.97, 30
  - (UltraHD) 3840 x 2160p 23.98, 24, 25, 29.97, 30
  - (UltraHD) 3840 x 2160PsF 23.98, 24, 25, 29.97, 30
- 1x 3 Gb SDI (Level A or B-Dual Link)
  - (2K) 2048 x 1080p 23.98, 24, 25, 29.97, 30, 50, 59.94, 60
  - (2K) 2048 x 1080PsF 23.98, 24, 25, 29.97, 30
  - (HD) 1920 x 1080p 23.98, 24, 25, 29.97, 30, 50, 59.94, 60
  - (HD) 1920 x 1080PsF 23.98, 24, 25, 29.97, 30
  - (HD) 1920 x 1080i 50, 59.94, 60
  - (HD) 1280 x 720p\*\* 50, 59.94, 60
- 2x 1.5 Gb SDI
  - (HD) 1920 x 1080p 50, 59.94, 60

- 1x 1.5 Gb SDI
  - (2K) 2048 x 1080p 23.98, 24, 25, 29.97, 30
  - (2K) 2048 x 1080PsF 23.98, 24, 25, 29.97, 30
  - (HD) 1920 x 1080p 23.98, 24, 25, 29.97, 30
  - (HD) 1920 x 1080PsF 23.98, 24, 25, 29.97, 30
  - (HD) 1920 x 1080i 50, 59.94, 60
  - (HD) 1280 x 720p 50, 59.94, 60
- 1x 270 Mb SDI
  - (SD) 625i 50
  - (SD) 525i 59.94

\*PsF is Level B-Dual Link

\*\*1280 x 720p is Level A Only

## Video Output Digital

---

- 1x 3G-SDI BNC, SMPTE-259/292/372/424
- Color space and sampling match input signal
- 1x 3 Gb SDI (Level A or B-Dual Link)
  - (2K) 2048 x 1080p 23.98, 24, 25, 29.97, 30, 50, 59.94, 60
  - (2K) 2048 x 1080PsF 23.98, 24, 25, 29.97, 30
  - (HD) 1920 x 1080p 23.98, 24, 25, 29.97, 30, 50, 59.94, 60
  - (HD) 1920 x 1080PsF 23.98, 24, 25, 29.97, 30
  - (HD) 1920 x 1080i 50, 59.94, 60
  - (HD) 1280 x 720p\* 50, 59.94, 60
- 1x 1.5 Gb SDI
  - (2K) 2048 x 1080p 23.98, 24, 25, 29.97, 30
  - (2K) 2048 x 1080PsF 23.98, 24, 25, 29.97, 30
  - (HD) 1920 x 1080p 23.98, 24, 25, 29.97, 30
  - (HD) 1920 x 1080PsF 23.98, 24, 25, 29.97, 30
  - (HD) 1920 x 1080i 50, 59.94, 60
  - (HD) 1280 x 720p 50, 59.94, 60
- 1x 270 Mb SDI
  - (SD) 625i 50
  - (SD) 525i 59.94
- 1x HDMI Type A connector, HDMI v1.4
  - YCbCr 4:2:2/4:4:4
  - RGB 4:4:4, SMPTE or Full level
  - 8 or 10-bit (4:4:4 limited to 8 bit)
  - (2K) 2048 x 1080p 23.98, 24, 25, 29.97, 30, 50, 59.94, 60
  - (HD) 1920 x 1080p 23.98, 24, 25, 29.97, 30, 50, 59.94, 60
  - (HD) 1920 x 1080i 50, 59.94, 60
  - (HD) 1280 x 720p 50, 59.94, 60
  - (SD) 720 x 576i 50
  - (SD) 720 x 480i 59.94

\*1280 x 720p is Level A Only

## Audio Input Digital

---

- SDI embedded audio, 24-bit, 8-Channel



## Audio Output Digital

---

- SDI embedded audio, 24-bit, 8-Channel
- HDMI embedded audio, 24-bit, 8-Channel

## User Interface

---

- USB port used with supplied cable and Mini-Config software application to configure device via Mac or Windows

## Size (w x d x h)

---

- 5.76" x 4.02" x 0.90" (146.31 × 102.11 × 22.86 mm)

## Weight

---

- 0.6 lb (0.3 kg)

## Power

---

- 5-20VDC regulated, 11 watts, power supply required, included with purchase
- AC Adapter: 100-240VAC, 50/60 Hz, universal input power

## Environment

---

- Safe Operating Temperature: 0 to 40 C (32 to 104 F)
- Safe Storage Temperature (Power OFF): -40 to 60 C (-40 to 140 F)
- Operating Relative Humidity: 10-90% noncondensing
- Operating Altitude: <3,000 meters (<10,000 feet)

# Appendix B – Safety and Compliance

---

## Federal Communications Commission (FCC) Compliance Notices

---

### Class B Interference Statement

---

This equipment has been tested and found to comply with the limits for a Class B digital device, pursuant to Part 15, Subpart B of the FCC Rules. These limits are designed to provide reasonable protection against harmful interference in a residential installation. This equipment generates, uses, and can radiate radio frequency energy and, if not installed and used in accordance with the instructions, may cause harmful interference to radio communications. However, there is no guarantee that interference will not occur in a particular installation. If this equipment does cause harmful interference to radio or television reception, which can be determined by turning the equipment off and on, the user is encouraged to try to correct the interference by one or more of the following measures:

- Reorient or relocate the receiving antenna.
- Increase the separation between the equipment and receiver.
- Connect the equipment into an outlet on a circuit different from that to which the receiver is connected.
- Consult the dealer or an experienced radio/TV technician for help.

### FCC Caution

---

This device complies with Part 15 of the FCC Rules. Operation is subject to the following two conditions: (1) This device may not cause harmful interference, and (2) this device must accept any interference received, including interference that may cause undesired operation.

## Canadian ICES Statement

---

### Canadian Department of Communications Radio Interference Regulations

This digital apparatus does not exceed the Class B limits for radio-noise emissions from a digital apparatus as set out in the Radio Interference Regulations of the Canadian Department of Communications. This Class B digital apparatus complies with Canadian ICES-003.

### Règlement sur le brouillage radioélectrique du ministère des Communications

Cet appareil numérique respecte les limites de bruits radioélectriques visant les appareils numériques de classe B prescrites dans le Règlement sur le brouillage radioélectrique du ministère des Communications du Canada. Cet appareil numérique de la Classe B est conforme à la norme NMB-003 du Canada.

## European Union and European Free Trade Association (EFTA) Regulatory Compliance

---

This equipment may be operated in the countries that comprise the member countries of the European Union and the European Free Trade Association. These countries, listed in the following paragraph, are referred to as The European Community throughout this document:

AUSTRIA, BELGIUM, BULGARIA, CYPRUS, CZECH REPUBLIC, DENMARK, ESTONIA, FINLAND, FRANCE, GERMANY, GREECE, HUNGARY, IRELAND, ITALY, LATVIA, LITHUANIA, LUXEMBOURG, MALTA, NETHERLANDS, POLAND, PORTUGAL, ROMANIA, SLOVAKIA, SLOVENIA, SPAIN, SWEDEN, UNITED KINGDOM, ICELAND, LICHTENSTEIN, NORWAY, SWITZERLAND

## Declaration of Conformity

Marking by this symbol indicates compliance with the Essential Requirements of the EMC Directive of the European Union 2004/108/EC.



This equipment meets the following conformance standards:

This equipment meets the following conformance standards:

### Safety

EN 60065: 2002 + A1: 2006 + A11: 2008 + A2: 2010 + A12: 2011 (GS License)

IEC 60065: 2001 + A1: 2005 + A2: 2010 (CB Scheme Report/Certificate)

Additional licenses issued for specific countries available on request.

### Emissions

EN 55103-1: 2009, CISPR 22: 2008, EN 61000-3-2: 2009-04, EN 61000-3-3: 2008-06

Environments: E2, E3 and E4

### Immunity

EN 55103-2: 2009, EN 61000-4-2: 2008-12, EN 61000-4-3: 2010-04, EN 61000-4-4: 2011-03,

EN 61000-4-5: 2005-11, EN 61000-4-6: 2008-10, EN 61000-4-11: 2004-03

Environments: E2, E3 and E4

The product is also licensed for additional country specific standards as required for the International Marketplace.



**Warning!** This is a Class B product. In a domestic environment, this product may cause radio interference, in which case, the user may be required to take appropriate measures.

**Achtung!** Dieses ist ein Gerät der Funkstörgrenzwertklasse B. In Wohnbereichen können bei Betrieb dieses Gerätes Rundfunkstörungen auftreten, in welchen Fällen der Benutzer für entsprechende Gegenmaßnahmen verantwortlich ist.

**Attention!** Ceci est un produit de Classe B. Dans un environnement domestique, ce produit risque de créer des interférences radioélectriques, il appartiendra alors à l'utilisateur de prendre les mesures spécifiques appropriées.

## Recycling Notice



This symbol on the product or its packaging indicates that this product must not be disposed of with your other household waste. Instead, it is your responsibility to dispose of your waste equipment by handing it over to a designated collection point for the recycling of waste electrical and electronic equipment. The separate collection and recycling of your waste equipment at the time of disposal will help conserve natural resources and ensure that it is recycled in a manner that protects human health and the environment. For more information about where you can drop off your waste for recycling, please contact your local authority, or where you purchased your product.

## Korea KCC Compliance Statement

<p>B급 기기 (가정용 방송통신기자재)</p>	<p>이 기기는 가정용(B급) 전자파적합기기로서 주로 가정에서 사용하는 것을 목적으로 하며, 모든 지역에서 사용할 수 있습니다.</p>
<p>Class B (Broadcasting Communication Equipment for Home Use)</p>	<p>As an electromagnetic wave equipment for home use (Class B), this equipment is intended to use mainly for home use and may be used in all areas.</p>

## Taiwan Compliance Statement

警告使用者：  
這是甲類的資訊產品，在居住的環境中使用時，可能會造成射頻干擾，在這種情況下，使用者會被要求採取某些適當的對策。

This is a Class B product based on the standard of the Bureau of Standards, Metrology and Inspection (BSMI) CNS 13438, Class B. In a domestic environment this product may cause radio interference in which case the user may be required to take adequate measures.

## Japanese Compliance Statement

この装置は、クラスB情報技術装置です。この装置は、家庭環境で使用することを目的としていますが、この装置がラジオやテレビジョン受信機に近接して使用されると、受信障害を引き起こすことがあります。  
取扱説明書に従って正しい取り扱いをして下さい。 VCCI-B

This is a Class B product based on the standard of the VCCI Council (VCCI V-3/2014.04). If this is used near a radio or television receiver in a domestic environment, it may cause radio interference. Install and use the equipment according to the instruction manual.

## Translated Warning and Caution Messages

The following caution statements, warning conventions, and warning messages apply to this product and manual.



Warning Symbol



Caution Symbol

## Before Operation Please Read These Instructions



**Warning!** Read and follow all warning notices and instructions marked on the product or included in the documentation.

**Avertissement!** Lisez et conformez-vous à tous les avis et instructions d'avertissement indiqués sur le produit ou dans la documentation.

**Warnung!** Lesen und befolgen Sie die Warnhinweise und Anweisungen, die auf dem Produkt angebracht oder in der Dokumentation enthalten sind.

**¡Advertencia!** Lea y siga todas las instrucciones y advertencias marcadas en el producto o incluidas en la documentación.

**Aviso!** Leia e siga todos os avisos e instruções assinalados no produto ou incluídos na documentação.

**Avviso!** Leggere e seguire tutti gli avvisi e le istruzioni presenti sul prodotto o inclusi nella documentazione.



**Warning!** Do not use this device near water and clean only with a dry cloth.

**Avertissement!** N'utilisez pas cet appareil près de l'eau et nettoyez-le seulement avec un tissu sec.

**Warnung!** Das Gerät nicht in der Nähe von Wasser verwenden und nur mit einem trockenen Tuch säubern.

**¡Advertencia!** No utilice este dispositivo cerca del agua y límpielo solamente con un paño seco.

**Aviso!** Não utilize este dispositivo perto da água e limpe-o somente com um pano seco.

**Avviso!** Non utilizzare questo dispositivo vicino all'acqua e pulirlo soltanto con un panno asciutto.



**Warning!** Do not block any ventilation openings. Install in accordance with the manufacturer's instructions.

**Avertissement!** Ne bloquez aucune ouverture de ventilation. Suivez les instructions du fabricant lors de l'installation.

**Warnung!** Die Lüftungsöffnungen dürfen nicht blockiert werden. Nur gemäß den Anweisungen des Herstellers installieren.

**¡Advertencia!** No bloquee ninguna de las aberturas de la ventilación. Instale de acuerdo con las instrucciones del fabricante.

**Aviso!** Não obstrua nenhuma das aberturas de ventilação. Instale de acordo com as instruções do fabricante.

**Avviso!** Non ostruire le aperture di ventilazione. Installare in conformità con le istruzioni del fornitore.



**Warning!** Do not install near any heat sources such as radiators, heat registers, stoves, or other apparatus (including amplifiers) that produce heat.

**Avertissement!** N'installez pas l'appareil près d'une source de chaleur telle que des radiateurs, des bouches d'air de chauffage, des fourneaux ou d'autres appareils (amplificateurs compris) qui produisent de la chaleur.

**Warnung!** Nicht in der Nähe von Wärmequellen wie Heizkörpern, Heizregistern, Öfen oder anderen Wärme erzeugenden Geräten (einschließlich Verstärkern) aufstellen.

**¡Advertencia!** No instale cerca de fuentes de calor tales como radiadores, registros de calor, estufas u otros aparatos (incluidos amplificadores) que generan calor.

**Aviso!** Não instale perto de nenhuma fonte de calor tal como radiadores, saídas de calor, fogões ou outros aparelhos (incluindo amplificadores) que produzam calor.

**Avviso!** Non installare vicino a fonti di calore come termosifoni, diffusori di aria calda, stufe o altri apparecchi (amplificatori compresi) che emettono calore



**Warning!** Do not defeat the safety purpose of the polarized or grounding-type plug. A polarized plug has two blades with one wider than the other. A grounding type plug has two blades and a third grounding prong. The wide blade or the third prong are provided for your safety. If the provided plug does not fit into your outlet, consult an electrician for replacement of the obsolete outlet.

**Avertissement!** La sécurité de la prise polarisée ou de la prise de type mise à la terre ne doit en aucun cas être empêchée de fonctionner. Une prise polarisée a deux broches, l'une étant plus large que l'autre. Une prise de type mise à la terre a deux broches et une troisième broche pour la mise à la terre. La broche large ou la troisième broche sont fournies pour votre sécurité. Si la prise fournie ne s'insère pas dans votre prise femelle, consultez un électricien pour le remplacement de la prise femelle obsolète.

**Warnung!** Der Sicherheitszweck des gepolten bzw. Schukosteckers ist zu berücksichtigen. Ein gepolter Stecker verfügt über zwei Pole, von denen einer breiter als der andere ist. Ein Schukostecker verfügt neben den zwei Polen noch über einen dritten Pol zur Erdung. Der breite Pol bzw. der Erdungspol dienen der Sicherheit. Wenn der zur Verfügung gestellte Stecker nicht in Ihren Anschluss passt, konsultieren Sie einen Elektriker, um den veralteten Anschluss zu ersetzen.

**¡Advertencia!** No eche por tierra la finalidad del tipo de enchufe polarizado con conexión a tierra. Un enchufe polarizado tiene dos espigas, una más ancha que la otra. Un enchufe con conexión a tierra tiene dos espigas iguales y una tercera espiga que sirve para la conexión a tierra. La espiga ancha, o la tercera espiga, sirven para su seguridad. Si el enchufe suministrado no encaja en el tomacorriente, consulte con un electricista para reemplazar el tomacorriente obsoleto.

**Aviso!** Não anule a finalidade da segurança da ficha polarizada ou do tipo ligação terra. Uma ficha polarizada tem duas lâminas sendo uma mais larga do que a outra. Uma ficha do tipo de ligação à terra tem duas lâminas e um terceiro terminal de ligação à terra. A lâmina larga ou o terceiro terminal são fornecidos para sua segurança. Se a ficha fornecida não couber na sua tomada, consulte um electricista para a substituição da tomada obsoleta.

**Avviso!** Non compromettere la sicurezza della spina polarizzata o con messa a terra. Una spina polarizzata ha due spinotti, di cui uno più largo. Una spina con messa a terra ha due spinotti e un terzo polo per la messa a terra. Lo spinotto largo o il terzo polo sono forniti per motivi di sicurezza. Se la spina fornita non si inserisce nella presa di corrente, contattare un elettricista per la sostituzione della presa obsoleta.



**Warning!** Since the Mains plug is used as the disconnection for the device, it must remain readily accessible and operable.

**Avertissement!** Puisque la prise principale est utilisée pour débrancher l'appareil, elle doit rester aisément accessible et fonctionnelle.

**Warnung!** Da der Netzstecker als Trennvorrichtung dient, muss er stets zugänglich und funktionsfähig sein.

**¡Advertencia!** Puesto que el enchufe de la red eléctrica se utiliza como dispositivo de desconexión, debe seguir siendo fácilmente accesible y operable.

**Aviso!** Dado que a ficha principal é utilizada como a desconexão para o dispositivo, esta deve manter-se prontamente acessível e funcional.

**Avviso!** Poiché il cavo di alimentazione viene usato come dispositivo di sconnessione, deve rimanere prontamente accessibile e operabile.



**Warning!** Protect the power cord from being walked on or pinched particularly at plugs, convenience receptacles, and the point where they exit from the device.

**Avertissement!** Protégez le cordon d'alimentation pour que l'on ne marche pas dessus ou qu'on le pince, en particulier au niveau des prises mâles, des réceptacles de convenance, et à l'endroit où il sort de l'appareil.

**Warnung!** Vermeiden Sie, dass auf das Netzkabel getreten oder das Kabel geknickt wird, insbesondere an den Steckern, den Steckdosen und am Kabelausgang am Gerät.

**¡Advertencia!** Proteja el cable de energía para que no se le pise ni apriete, en especial cerca del enchufe, los receptáculos de conveniencia y el punto del que salen del equipo.

**Aviso!** Proteja o cabo de alimentação de ser pisado ou de ser comprimido particularmente nas fichas, em tomadas de parede de conveniência e no ponto de onde sai do dispositivo.

**Avviso!** Proteggere il cavo di alimentazione in modo che nessuno ci cammini sopra e che non venga schiacciato soprattutto in corrispondenza delle spine e del punto in cui esce dal dispositivo.



**Warning!** Unplug this device during lightning storms or when unused for long periods of time.

**Avertissement!** Débranchez cet appareil pendant les orages avec éclairsoù s'il est inutilisé pendant de longues périodes.

**Warnung!** Das Gerät ist bei Gewitterstürmen oder wenn es über lange Zeiträume ungenutzt bleibt vom Netz zu trennen.

**¡Advertencia!** Desenchufe este dispositivo durante tormentas eléctricas o cuando no se lo utilice por largos periodos del tiempo.

**Aviso!** Desconecte este dispositivo da tomada durante trovoadas ou quando não é utilizado durante longos períodos de tempo.

**Avviso!** Utilizzare soltanto i collegamenti e gli accessori specificati e/o venduti dal produttore, quali il treppiedi e l'esoscheletro.



**Warning!** Do not open the chassis. There are no user-serviceable parts inside. Opening the chassis will void the warranty unless performed by an AJA service center or licensed facility.

**Avertissement!** Ne pas ouvrir le châssis. Aucun élément à l'intérieur du châssis ne peut être réparé par l'utilisateur. La garantie sera annulée si le châssis est ouvert par toute autre personne qu'un technicien d'un centre de service ou d'un établissement agréé AJA.

**Warnung!** Öffnen Sie das Gehäuse nicht. Keine der Geräteteile können vom Benutzer gewartet werden. Durch das Öffnen des Gehäuses wird die Garantie hinfällig, es sei denn, solche Wartungsarbeiten werden in einem AJA-Service-Center oder einem lizenzierten Betrieb vorgenommen.

**¡Advertencia!** No abra el chasis. El interior no contiene piezas reparables por el usuario. El abrir el chasis anulará la garantía a menos que se lo haga en un centro de servicio AJA o en un local autorizado.

**Advertência!** Não abra o chassi. Não há internamente nenhuma peça que permita manutenção pelo usuário. Abrir o chassi anula a garantia, a menos que a abertura seja realizada por uma central de serviços da AJA ou por um local autorizado.

**Avvertenza!** Non aprire lo chassis. All'interno non ci sono parti riparabili dall'utente. L'apertura dello chassis invaliderà la garanzia se non viene effettuata da un centro ufficiale o autorizzato AJA.





**Warning!** Disconnect the external AC power supply line cord(s) from the mains power before moving the unit.

**Avertissement!** Retirez le ou les cordons d'alimentation en CA de la source d'alimentation principale lorsque vous déplacez l'appareil.

**Warnung!** Trennen Sie die Wechselstrom-Versorgungskabel vom Netzstrom, bevor Sie das Gerät verschieben.

**¡Advertencia!** Cuando mueva la unidad desenchufe de la red eléctrica el/los cable(s) de la fuente de alimentación CA tipo brick.

**Advertência!** Remova os cabos CA de alimentação brick da rede elétrica ao mover a unidade.

**Avvertenza!** Scollegare il cavo dell'alimentatore quando si sposta l'unità.



**Warning!** Refer all servicing to qualified service personnel. Servicing is required when the device has been damaged in any way, such as power-supply cord or plug is damaged, liquid has been spilled or objects have fallen into the device, the device has been exposed to rain or moisture, does not operate normally, or has been dropped.

**Avertissement!** Référez-vous au personnel de service qualifié pour tout entretien. L'entretien est exigé quand l'appareil a été endommagé de quelque manière que ce soit, par exemple lorsque le cordon d'alimentation ou la prise sont endommagés, que du liquide a été versé ou des objets sont tombés dans l'appareil, que l'appareil a été exposé à la pluie ou à l'humidité, ne fonctionne pas normalement ou est tombé.

**Warnung!** Das Gerät sollte nur von qualifizierten Fachkräften gewartet werden. Eine Wartung ist fällig, wenn das Gerät in irgendeiner Weise beschädigt wurde, wie bei beschädigtem Netzkabel oder Netzstecker, falls Flüssigkeiten oder Objekte in das Gerät gelangen, das Gerät Regen oder Feuchtigkeit ausgesetzt wurde, nicht ordnungsgemäß funktioniert oder fallen gelassen wurde.

**¡Advertencia!** Consulte al personal calificado por cuestiones de reparación. El servicio de reparación se requiere cuando el dispositivo ha recibido cualquier tipo de daño, por ejemplo cable o espigas dañadas, se ha derramado líquido o se han caído objetos dentro del dispositivo, el dispositivo ha sido expuesto a la lluvia o humedad, o no funciona de modo normal, o se ha caído.

**Aviso!** Remeta todos os serviços de manutenção para o pessoal de assistência qualificado. A prestação de serviços de manutenção é exigida quando o dispositivo foi danificado mediante qualquer forma, como um cabo de alimentação ou ficha que se encontra danificado/a, quando foi derramado líquido ou caíram objectos sobre o dispositivo, quando o dispositivo foi exposto à chuva ou à humidade, quando não funciona normalmente ou quando foi deixado cair.

**Avviso!** Fare riferimento al personale qualificato per tutti gli interventi di assistenza. L'assistenza è necessaria quando il dispositivo è stato danneggiato in qualche modo, ad esempio se il cavo di alimentazione o la spina sono danneggiati, è stato rovesciato del liquido è stato rovesciato o qualche oggetto è caduto nel dispositivo, il dispositivo è stato esposto a pioggia o umidità, non funziona correttamente o è caduto

# Warranty Information

---

## Limited Warranty

---

AJA Video Systems, Inc. (AJA Video) warrants that this product will be free from defects in materials and workmanship for a period of five years from the date of purchase. If a product proves to be defective during this warranty period, AJA Video, at its option, will either repair the defective product without charge for parts and labor, or will provide a replacement in exchange for the defective product.

In order to obtain service under this warranty, you the Customer, must notify AJA Video of the defect before the expiration of the warranty period and make suitable arrangements for the performance of service. The Customer shall be responsible for packaging and shipping the defective product to a designated service center nominated by AJA Video, with shipping charges prepaid. AJA Video shall pay for the return of the product to the Customer if the shipment is to a location within the country in which the AJA Video service center is located. Customer shall be responsible for paying all shipping charges, insurance, duties, taxes, and any other charges for products returned to any other locations.

This warranty shall not apply to any defect, failure or damage caused by improper use or improper or inadequate maintenance and care. AJA Video shall not be obligated to furnish service under this warranty a) to repair damage resulting from attempts by personnel other than AJA Video representatives to install, repair or service the product, b) to repair damage resulting from improper use or connection to incompatible equipment, c) to repair any damage or malfunction caused by the use of non-AJA Video parts or supplies, or d) to service a product that has been modified or integrated with other products when the effect of such a modification or integration increases the time or difficulty of servicing the product.

THIS WARRANTY IS GIVEN BY AJA VIDEO IN LIEU OF ANY OTHER WARRANTIES, EXPRESS OR IMPLIED. AJA VIDEO AND ITS VENDORS DISCLAIM ANY IMPLIED WARRANTIES OF MERCHANTABILITY OR FITNESS FOR A PARTICULAR PURPOSE. AJA VIDEO'S RESPONSIBILITY TO REPAIR OR REPLACE DEFECTIVE PRODUCTS IS THE WHOLE AND EXCLUSIVE REMEDY PROVIDED TO THE CUSTOMER FOR ANY INDIRECT, SPECIAL, INCIDENTAL OR CONSEQUENTIAL DAMAGES IRRESPECTIVE OF WHETHER AJA VIDEO OR THE VENDOR HAS ADVANCE NOTICE OF THE POSSIBILITY OF SUCH DAMAGES.

# Index

---

## Symbols

- 2K Crop 16
- 2SI 15
- 3Gb Mode 16
- 3G-B Mode 15
- 4K2HD
  - Modes 4
- 4K Convert 16
- 4K Down Conversion Mode 4
- 4K/UltraHD Dual-stream 3Gb SDI Input 5

## A

- AJA Support 2
- Audio Offset In Frames 18
- Audio Screen 18

## B

- Bit Depth 14, 17
- Block Diagram 7

## C

- Center Cut Mode 4
- Color Dithering 17
- Color Space 14
- Color Space 17

## D

- Default Operation 5
- Documentation
  - Download 9
  - Mini-Converter 9
- Dual-link 1.5Gb Input 5
- Dual-Stream 3G
  - Two Inputs 5

## E

- Edge Filtering 16

## F

- Features 6

## H

- HDMI Channel Count 18
- HDMI/DVI 17
- HDMI Output Control
  - Difference From SDI 5
- HDMI Screen 17

## I

- Info Screen 20
- Input Screen 14
- Input Source 18
- Installation 8

I/O Connections 7

## M

- Mapping 15
- Mini-Config Control 5
- Modes
  - 4K2HD 4

## N

- Non-4K Mode 4

## O

- Output Control Differences
  - HDMI and SDI 5
- Output Mode 16
- Output Screen 15

## P

- Passthrough 16

## Q

- Quadrant 15

## R

- RGB Range 14, 17

## S

- SDI inputs
  - Multiple 5
- SDI Output Control
  - Difference From HDMI 5
- SDI Passthrough 5
- Single HD Input 5
- Single SD Input 5
- Software Update Procedure 19
- Square Division 15

## T

- Technical Support 2
- Two Sample Interleave 15

## U

- Update Screen 19

## V

- Video Format 15
- Video Output 5
- Video Source 14