

# AS-950



## USER'S MANUAL

# **ANY SPOT<sup>®</sup>**

**WIRELESS PERSONAL MONITOR**

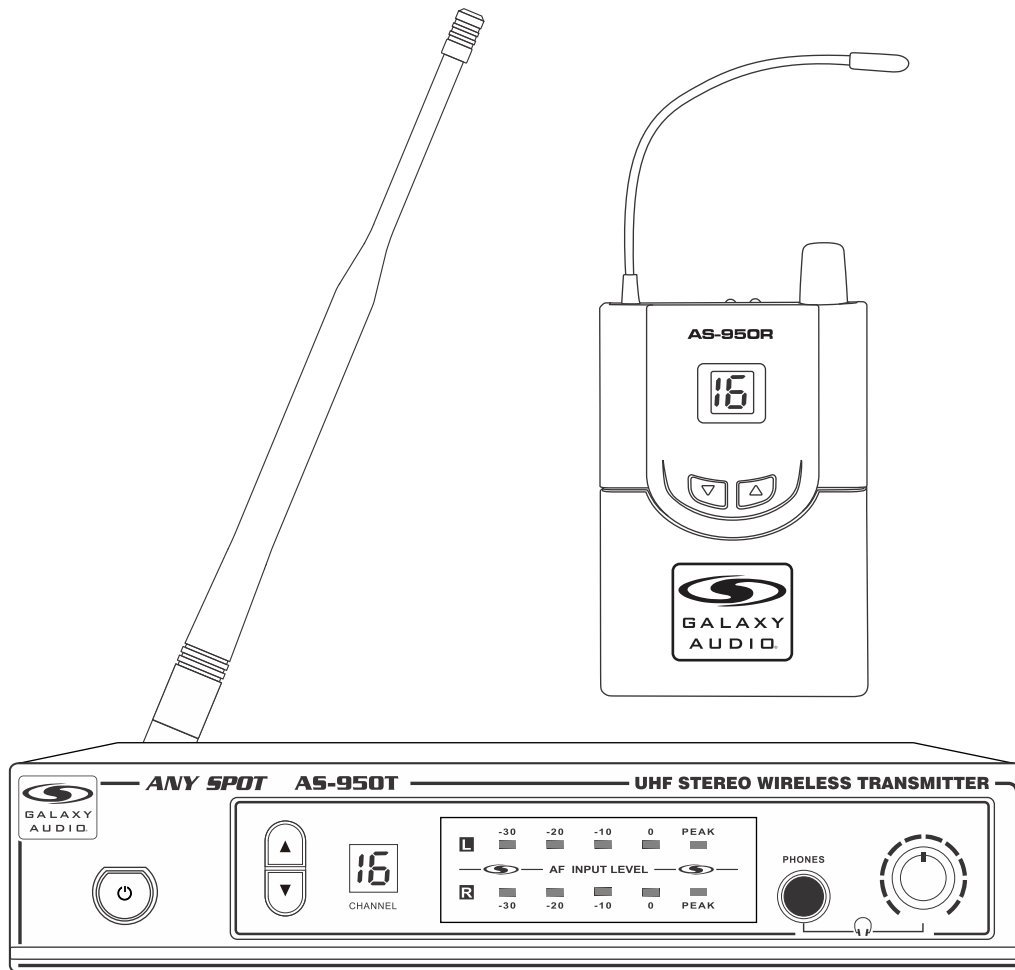

[www.galaxyaudio.com/products/AS-950](http://www.galaxyaudio.com/products/AS-950)



MAKERS OF THE ORIGINAL  
HOT SPOT PERSONAL MONITOR

(This page is intentionally left blank)



# Contents

Introduction.....	1
Safety.....	2
System Components.....	3
Rack Mounting AS-950.....	3
AS-950T Transmitter Features.....	4
AS-950R Receiver Features.....	5
System Setup.....	6
Specifications.....	7
Parts and Accessories.....	7
Wireless Tips.....	8

## Introduction

Thank you for choosing a Galaxy Audio professional wireless in-ear monitor system. You have joined the ranks of countless satisfied customers. Our years of professional experience in design and manufacturing ensure our products' quality, performance and reliability.

### 1. Introduction

1. EIA-standard metal materials half - rack transmitter chassis.
2. Durable, ergonomic plastic body Receiver with soft-touch controls.
3. 16 Selectable UHF frequencies
4. Designed to provide incredible audio quality and reliable performance for artists, broadcasters and other demanding audio environments.

### 2. Transmitter Installation and Connections

#### Installation

1. For better operation the transmitter should be at least 3ft. (1m) above the ground and at least 3ft. away from a wall or metal surface to minimize reflections.
2. Keep antennas away from noise sources such as computer, digital equipment, motors, automobiles and neon lights, as well as away from large metal objects.
3. Antenna are normally positioned 45° from vertical for best transmission.
4. Keep open space between the receiver and transmitter for better reception.
5. The transmitter should be at least 6ft. (2m) from the receiver.

#### Connections:

1. Power to the unit is controlled by the front panel power switch.
2. There are two line level audio inputs on the rear panel: 1/L and 2/R audio INPUTS. Suitable for an XLR balanced audio input connector or a balanced/unbalanced 1/4" (6.3mm) input connector. The two audio inputs simultaneous feed from two different outputs. Use the appropriate shielded audio cable for connections between the transmitter and the output(s) of the mixer or other audio output equipment.

# Safety



USING THIS SYSTEM AT EXCESSIVE VOLUMES CAN CAUSE PERMANENT HEARING DAMAGE. USE AS LOW A VOLUME AS POSSIBLE.

## WARNING!

In order to use this system safely, avoid prolonged listening at excessive sound pressure levels. Please use the following guidelines established by the Occupational Safety Health Administration (OSHA) on maximum time exposure to sound pressure levels before hearing damage occurs.

90 dB SPL at 8 hours	110 dB SPL at ½ hour
95 dB SPL at 4 hours	115 dB SPL at 15 minutes
100 dB SPL at 2 hours	120 dB SPL — avoid or damage may occur
105 dB SPL at 1 hour	

It is difficult to measure the exact Sound Pressure Levels (SPL) present at the eardrum in live applications. In addition to the volume setting on the Personal Monitors, the SPL in the ear is affected by ambient sound from floor wedges or other devices. The isolation provided by the fit of quality earpieces is also an important factor in determining the SPL.

Here are some general tips to follow in the use of this product to protect your ears from damage.

- Turn up the volume control only far enough to hear properly.
- Ringing in the ears may indicate that the gain levels are too high. Try lowering the gain levels.
- Have your ears checked by an audiologist on a regular basis. If you experience wax buildup in your ears, stop using the system until an audiologist has examined your ears.
- Wipe the ear molds with an antiseptic before and after use to avoid infections. Stop using the earphones if they are causing great discomfort or infection.

## ! IMPORTANT SAFETY INSTRUCTIONS !

1. READ these instructions.
2. KEEP these instructions.
3. HEED all warnings.
4. FOLLOW all instructions.
5. DO NOT use this apparatus near water.
6. CLEAN ONLY with dry cloth.
7. DO NOT block any ventilation openings. Install in accordance with the manufacturer's instructions.
8. DO NOT install near any heat sources such as radiators, heat registers, stoves, or other apparatus (including amplifiers) that produce heat.
9. DO NOT defeat the safety purpose of the polarized or grounding-type plug. A polarized plug has two blades with one wider than the other. A grounding type plug has two blades and a third grounding prong. The wider blade or the third prong are provided for your safety. If the provided plug does not fit into your outlet, consult an electrician for replacement of the obsolete outlet.
10. PROTECT the power cord from being walked on or pinched, particularly at plugs, convenience receptacles, and the point where they exit from the apparatus.
11. ONLY USE attachments/accessories specified by the manufacturer.
12. UNPLUG this apparatus during lightning storms or when unused for long periods of time.
13. REFER all servicing to qualified service personnel. Servicing is required when the apparatus has been damaged in any way, such as power-supply cord or plug is damaged, liquid has been spilled or objects have fallen into the apparatus, the apparatus has been exposed to rain or moisture, does not operate normally, or has been dropped.
14. DO NOT expose the apparatus to dripping and splashing. DO NOT put objects filled with liquids, such as vases, on the apparatus.
15. Remove the batteries from the receiver if the system will not be used for a long period of time. This will avoid any damage resulting from a defective, leaking battery.
16. DO NOT throw used batteries into a fire. Be sure to dispose of or recycle used batteries in accordance with local waste disposal laws.

## LICENSING INFORMATION

**THIS RADIO EQUIPMENT IS INTENDED FOR USE IN PROFESSIONAL ENTERTAINMENT AND SIMILAR APPLICATIONS.**

Changes or modifications not expressly approved by Galaxy Audio Incorporated could void your authority to operate the equipment. Licensing of Galaxy Audio wireless microphone equipment is the user's responsibility, and licensability depends on the user's classification and application, and on the selected frequency. Galaxy Audio strongly urges the user to contact the appropriate telecommunications authority concerning proper licensing, and before choosing and ordering frequencies.

**NOTE: THIS EQUIPMENT MAY BE CAPABLE OF OPERATING ON SOME FREQUENCIES NOT AUTHORIZED IN YOUR REGION. PLEASE CONTACT YOUR NATIONAL AUTHORITY TO OBTAIN INFORMATION ON AUTHORIZED FREQUENCIES FOR WIRELESS MICROPHONE PRODUCTS IN YOUR REGION**

**Licensing:** Note that a ministerial license to operate this equipment may be required in certain areas. Consult your national authority for possible requirements.

## FCC Consumer Alert for Wireless Microphones (U.S.)

Most users do not need a license to operate this wireless microphone system. Nevertheless, operating this microphone system without a license is subject to certain restrictions: the system may not cause harmful interference; it must operate at a low power level (not in excess of 50 milliwatts); and it has no protection from interference received from any other device. Purchasers should also be aware that the FCC is currently evaluating use of wireless microphone systems, and these rules are subject to change.

For more information, call the FCC at 1-888-CALL-FCC (TTY: 1-888-TELL-FCC) or visit the FCC's wireless microphone website at [www.fcc.gov/cgb/wirelessmicrophones](http://www.fcc.gov/cgb/wirelessmicrophones)

# System Components

All AS-950 systems include the following components:

- AS-950T Transmitter
- AS-950R Receiver
- Power Supply
- One Pair EB4 Ear Buds
- One Antenna
- Single/Dual Rack Kit
- Quickstart Guide

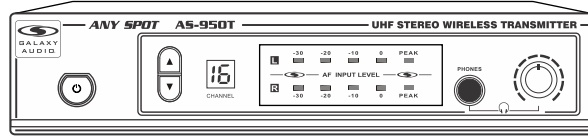

**AS-950T  
Transmitter**

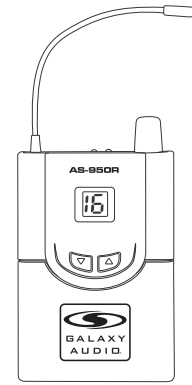

**AS-950R  
Body Pack Receiver**

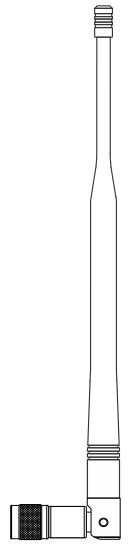

**Antenna**



**EB4  
Ear Buds**

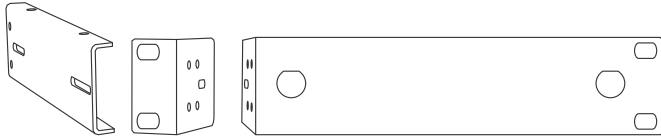

**MREWD  
Single/Dual Rack Kit**



M3/10 (x6)  
(For other Wireless Systems)



M3/5 (x2)  
(For Coupler)

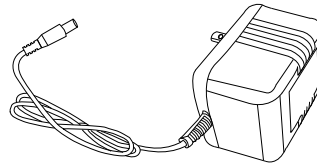

**PS-13.5-.35.5  
Power Supply**

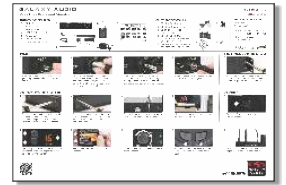

**Quick Start Guide**

## Attaching the Rack Ears

**What You Need for Rack Mounting:**  
(Not Included)

1. Rack Screws 10/32 x 0.75", Phillips Truss Head Screws



2. #2 Phillips Head Screwdriver



### For Racking a Single Unit:

1. Attach the long and short rack ears to either side of choice using the provided screws.

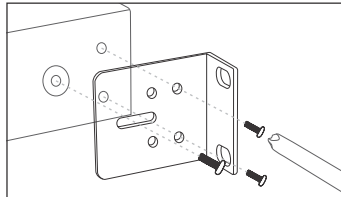

2. Align the unit up evenly. Turn the screw but leave room to adjust. Once all three screws are in place, tighten securely.

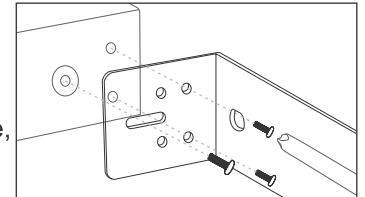

### For Racking a Two Units:

1. Attach the short rack ear to either side of choice using the provided screws.

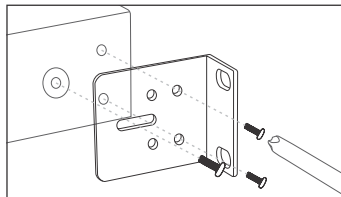

2. After removing the screw from the side of the unit, attach the coupler half to the other side using the provided screws.

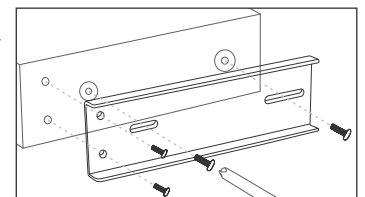

3. Align the two units so that the couplers overlap and the holes align. Using the provided coupler screws (M3/5), screw the couplers together securely.

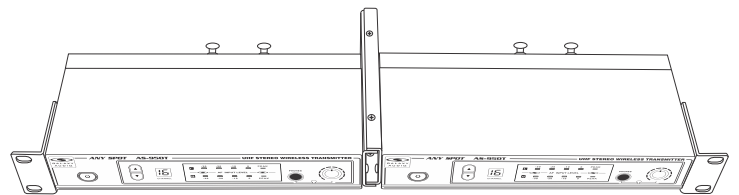
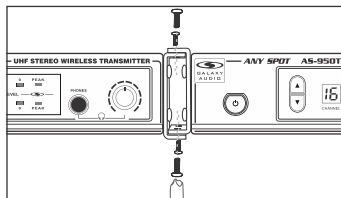

# AS-950T Transmitter Features

## AS-950 Wireless In-Ear Monitor System Transmitter

### Transmitter Features:

#### Front Panel

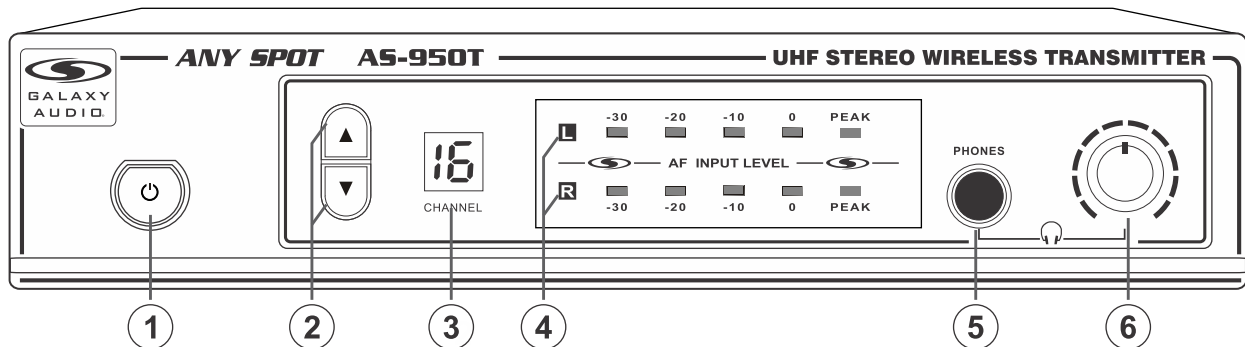

- ① - Power Switch: Press to switch on, meters will blink once. Press again to switch off.
- ② - Channel Select: Up ▲ and Down ▼ Buttons
- ③ - LCD Screen Channel Display
- ④ - Left/Right Channel Input Level Meters
- ⑤ - 1/4" 6.35 mm Stereo Headphone Jack
- ⑥ - Headphone Output Volume Control: Left turn for output level decrease, right turn for output level increase.

#### NOTE: POWER ON Indicator:

When the Power switch is activated on the AS-950 transmitter, the AF Input Level lights on the front of the unit will blink once to indicate power has been applied. These meter lights will not remain lit unless a signal is present at one or both inputs, and the respective AF Level input level controls on the back of the unit are adjusted as needed. If the AF Input Level lights blink when powered but no continuous lights are present despite having a signal on either input, please check the AF Level controls, and ensure that the incoming signal level is strong enough to register on the meter.

#### Back Panel

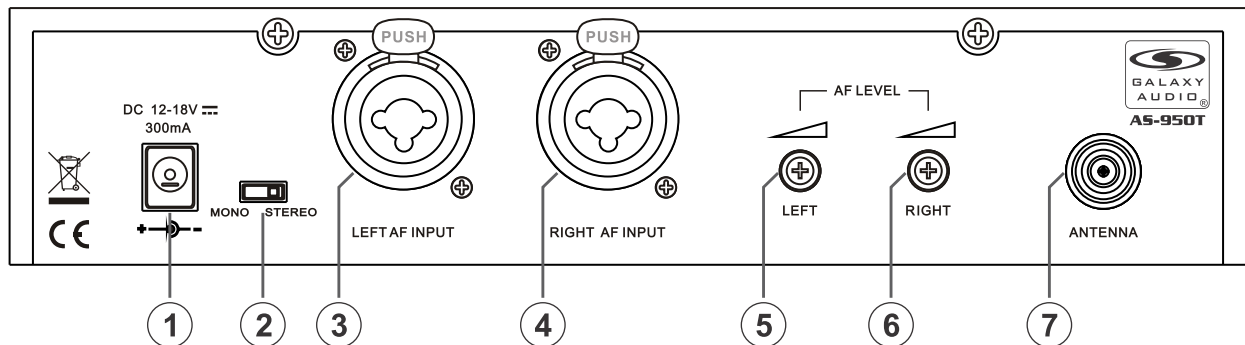

- ① - DC Power Input Jack.
- ② - Stereo/Mono Switch: Stereo position preserves Left/Right signals throughout system. Mono position mixes Left/Right signals together.
- ③ - Left Channel XLR/1/4" Combo Input Jack.
- ④ - Right Channel XLR/1/4" Combo Input Jack.
- ⑤ - Left Channel Input Level Control.
- ⑥ - Right Channel Input Level Control.
- ⑦ - Antenna Jack. 50 ohms.

# AS-950R Receiver Features

## AS-950 Wireless In-Ear Monitor Body Pack Receiver

### Body Pack Receiver Features:

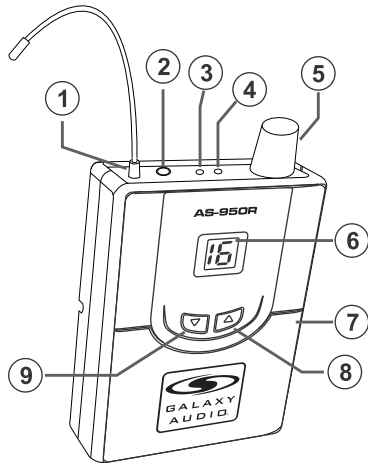

### Features:

- ① - Antenna
- ② - Stereo Headphone Jack 1/8" (3.5 mm)
- ③ - RF Signal LED: Lights up when RF Signal is Received.
- ④ - Stereo LED: LED Lights up when transmitter stereo switch is on
- ⑤ - Audio Output Control and On/Off Switch
- ⑥ - LCD Screen: Displays Channel
- ⑦ - Battery Compartment: Insert batteries here. (Two AA 1.5VDC Alkaline recommended)
- ⑧ - Channel UP Button
- ⑨ - Channel DOWN Button

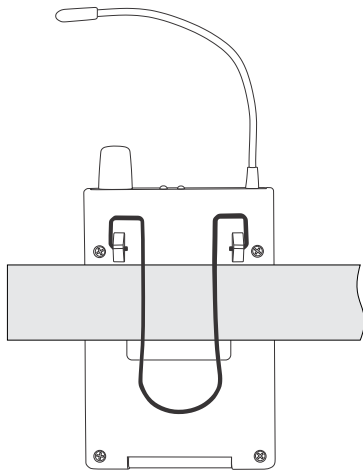

### Wearing the Body Pack Receiver

**Belt Clip:** For best results, clip the receiver onto a belt by pushing the receiver down onto the belt as far as possible.

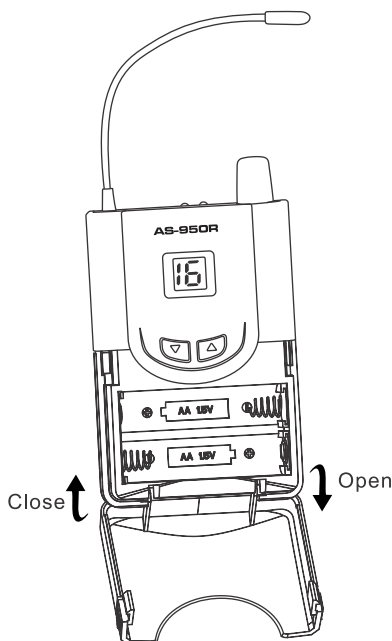

### Changing Batteries

Expected life for two AA Alkaline batteries is approximately 12 hours. When the LCD display is flashing, the batteries should be replaced.

## System Setup



Fig. 1



Fig. 2



Fig. 3

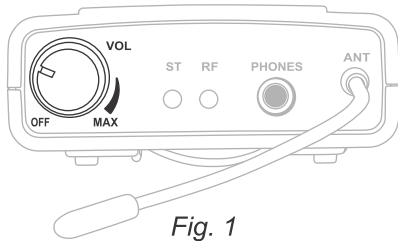

Fig. 1



Fig. 2

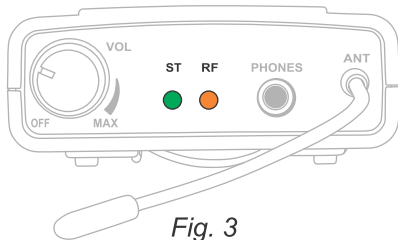

Fig. 3

### Programming the Transmitter

#### 1. Power On:

Press and hold the power button for 2 seconds to power on the transmitter. The AF Input Level lights on the front of the unit will blink once to indicate power has been applied. Press and hold for 2 seconds again to turn off.

#### 2. Channel Selection:

Press ▲ or ▼ buttons to select a suitable Channel number. The display will show the number of channel selected.

Note: When using multiple systems, set each system to a different channel.

#### 3. Stereo/Mono Input Mode Selection:

On the back of the unit, move the Stereo/Mono switch to the preferred mode. Stereo position preserves Left/Right signals throughout system.

Mono position mixes Left/Right signals together.

### Programming the Body Pack Receiver

#### 1. Power On:

Turn the Body Pack on by turning the volume control clock-wise. The LCD display will light up as shown in Fig. 1.

#### 2. Channel Selection:

Press ▲ or ▼ to match the transmitter CHANNEL number as shown in Fig. 2. The display will show the channel number selected.

Note: When using multiple systems, set each system to a different channel.

#### 3. Stereo/Mono:

If the transmitter has the switch set to Stereo, the stereo LED indicator will light green as shown in Fig. 3.

#### 4. RF Signal Indication:

If the Receiver receives an RF signal, the RF LED indicator will light orange as shown in Fig. 3.



# Specifications

## System

**Band:** UHF

**Frequencies:** 16 Selectable Frequencies

**Frequency Range:** CODE N: 518 - 542 MHz  
CODE P2: 470 - 489 MHz

**Transmitter Output Level:** 10 mW

**Operating Range:** Under Typical Conditions 200' (61m)

Note: actual range depends on RF signal absorption, reflection, interference, and battery characteristics

**Audio Frequency Response:** +/-3dB 50Hz~15kHz

**Total Harmonic Distortion:** <1% @ 1kHz

**Signal to Noise:** >80dBA

**Maximum Deviation Range:** +/-40kHz

**Dynamic Range:** >90dB A-weighted

**Operating Temperature Range:** 14°F to 122°F (-10° C to +50° C)

Note: battery characteristics may limit this range

## Transmitter

**Main Frame Size:** EIA STANDARD 1/2U

**Modulation Mode:** FM Stereo Modulation

**RF Output:** 10 mW

**Max Audio Input Level:** +6dBV

**Gain Adjustment Range:** 40dB

**Controls:** Headphone Volume, Up/Down, and Power Button

**Audio Input:** Line Level x 2, XLR/1/4" Combo Jack

**XLR Input:** Impedance balanced

**Pin:** 1 Ground (cable shield)

**Pin:** 2 Audio +

**Pin:** 3 No Audio -

**Dimensions:** 1.73" x 8.34" x 3.77" (44 x 212 x 96 mm)(HxWxD)

**Weight:** 19.75 oz (560 g)

**Power Supplied By:** 12-18 V DC at 300mA supplied by external power supply

## Receiver

**Audio Output Level:** 50mW x 2

**Sensitivity:** -94dBm for 30dB

**Stereo Separation:** 40dB (at 1kHz)

**Output Connector:** 1/8" (3.5mm) Stereo Earphone Connector

**Controls:** Volume, Up, Down

**Indicators:** LCD Display, Stereo LED, RF LED

**Dimensions:** 3.54" x 2.51" x 0.9" (90 x 64 x 23 mm)(HxWxD)

**Weight:** 3.35 oz (95 g) without batteries

**Power Supplied By:** 2 (AA) size alkaline or rechargeable batteries

**Battery Life:** About 12 hours (alkaline)

**GALAXY AUDIO**  
Frequency Page



Please click or scan the QR for the most current frequency information.

<http://www.galaxyaudio.com/support/schematics-and-frequency-charts>

# Parts and Accessories

Many of these parts and accessories may be found and purchased from the Galaxy Audio website in the Galaxy Store ([www.galaxyaudio.com/parts-and-accessories](http://www.galaxyaudio.com/parts-and-accessories)).



**EXTBNC** - BNC Cable for front mounting the antennas on the AS-950. For lengths available: 18", 25', 50', 100'



**CN-BNCPM** - BNC Connector for front mounting the antennas on the AS-950.



**ANT-PDL** - Directional antenna used to decrease interference to other equipment. Frequency range 500-900MHz  
The UHF wide-band (500-900 MHz) directional LPDA (log periodic dipole array) antenna reduces outside interference while providing increased send/receive signal range. Each antenna paddle is matched to 50 ohms impedance with a low-loss BNC connector; 7dBi gain. For permanent or temporary installation; mounts to 5/8"-27 threads.



**ANT950T** - Replacement BNC Antenna for use with Galaxy Audio Wireless Personal Monitors. (Part number will vary based on the Frequency Code of specific unit)



**AS-CLIP1576** - Replacement Belt Clip for AS-950R, MBP76R, and MBP77R Body Packs



**BATTCLRBP76** - Replacement Battery Cover for AS-950R, MBP76R, and MBP77R Body Pack.



**PS-13.5-.35.5** - 600mA Replacement Power Supply for AS-900, AS-950 AS-1100, AS-1400, EDX, ECM, PSE, & DHX.



**AS-UA12-14.5** - 1000mA Universal Power Supply for Replacement Power Supply for AS-900, AS-950 AS-1100, AS1400, AS-1800, EDX, ECM, PSE, DHX, DHXR4, & CTS. Includes adapters for most other countries.



**EB4** - Ear buds which come standard with our Wireless Personal Monitor Systems with 1/8" - 3.5mm Jack.



**EB4S** - Replacement Sleeves for EB4 Ear Buds. 5 pair in each pack. Available in Small, Medium, or Large.



**MREWD** - Replacement Single/Dual Rack Kit for AS-900, AS-950, AS-1100, & AS-1400

## Wireless Tips

Maintain line of sight between the transmitter and receiver antennas.

Do not have walls, metal objects, large crowds, etc. blocking the line of sight between the transmitter and receiver.

Antennas on the stationary equipment should be kept 6-8' above the ground.

Antennas can be mounted on stands or walls using brackets such as the ANT-LB.

On body pack receivers/transmitters, avoid putting them in your pocket, and/or folding the antenna under the pack. The antenna should hang freely and openly.

Keep the distance between transmitters and receivers as short as possible.

If distances above 20-30' are unavoidable, directional antennas such as the ANT-PDL can improve reception by rejecting signals outside their pickup angle.

Find out what TV stations are broadcasting in your area and avoid the channels they are on.

This information is available from many sources on line, such as [www.tvfool.com](http://www.tvfool.com).

If your receiver is showing that it is receiving RF when your transmitter is turned off, you need to move to another frequency.

If you are using several systems, you can contact [service@galaxyaudio.com](mailto:service@galaxyaudio.com) for assistance in frequency coordination.

Make certain you are using fresh batteries, rechargeable batteries may be used, but they discharge at a much faster rate than alkaline.

(This page is intentionally left blank)





MAKERS OF THE ORIGINAL  
HOT SPOT PERSONAL MONITOR



[www.galaxyaudio.com](http://www.galaxyaudio.com)

## ***THREE YEAR LIMITED WARRANTY***

**WARRANTY** Information can be viewed online at  
<https://www.galaxyaudio.com/support/warranty>



[www.galaxyaudio.com/support/warranty](http://www.galaxyaudio.com/support/warranty)

# **AS-950**

## **USER'S MANUAL**

Specifications in this manual are subject to change without notice.  
For the most up to date manual and information  
visit [www.galaxyaudio.com](http://www.galaxyaudio.com).

1-800-369-7768    [www.galaxyaudio.com](http://www.galaxyaudio.com)

© Copyright Galaxy Audio 2018