

Pioneer Dj

DJ Controller

DDJ-WeGO 4

DDJ-WEGO4

<http://pioneerdj.com/support/>
<http://rekordbox.com/>

For FAQs and other support information for this product, visit the above site.

Operating Instructions

Contents

How to read this manual

- Thank you for buying this Pioneer DJ product.
Be sure to read this manual and the “Operating Instructions (Quick Start Guide)” included with the unit. Both documents include important information that you should understand before using this product.
- In this manual, names of menus displayed on the product and on the computer screen, as well as names of buttons and terminals, etc., are indicated within brackets. (E.g.: **[File]**, **[CUE]** button, and **[PHONES]** output terminals)
- Please note that the screens and specifications of the software described in this manual as well as the external appearance and specifications of the hardware are currently under development and may differ from the final specifications.
- Please note that depending on the operating system version, web browser settings, etc., operation may differ from the procedures described in this manual.
- Please note that the language of the software screens described in this Operating Instructions may differ from the language of the actual screens.

This manual consists mainly of explanations on the functions of the hardware of this unit. For details on operating the DJ software, see the Operating Instructions of the DJ software.

01 Before start

Features	3
What’s in the box	3

02 Part names and functions

Top panel of unit	4
Rear panel	7
Side panel	7

03 Using WeDJ for iPhone / iPad

About WeDJ for iPhone / iPad	8
Connections	8
Start up the system	9
Operation	9
WeDJ Advanced Operation	10

04 Using djay 2 for iPhone / iPad, vjay for iPhone / iPad

Before using djay 2 for iPhone / iPad or vjay for iPhone / iPad	13
Connections	13
Start up the system	14
Operation	14

05 Using djay 2 for Android

Before using djay 2 for Android	16
Connections	16
Start up the system	18
Checking the audio device settings (only when Android 4.4)	18
Operation	18

06 Using rekordbox

Viewing the manuals	20
Install rekordbox	20
Preparing rekordbox	22
Adding track files to [Collection]	24
rekordbox Advanced Operation	25

07 Using VirtualDJ LE 8

Before installing VirtualDJ LE 8	28
Installing VirtualDJ LE 8	29
About the driver software and setting utility software	30
Connections	31

Start up the system	32
Operation	32

08 Changing the settings

Launching utilities mode	34
Utilities modes	34
Changing the settings with rekordbox	34
About the driver software and setting utility software	35

09 Additional information

Troubleshooting	36
Using as a controller for other DJ software	37
About trademarks and registered trademarks	38
Cautions on copyrights	38

Before start

Features

This unit is a compact size DJ Controller that enables DJ performances using dynamic sound changes and a wide variety of light changes. DJing can be enjoyed not just with a computer but also with an iPhone / iPad. The "PULSE CONTROL" function is provided to enable a wide variety of changes in light color using the LEDs of this unit.

Furthermore, an AC adapter and USB bus power are supported for the power source of this unit, enabling enjoyment of a DJ life that matches the preferences and style of the user.

Hybrid DJ Controller

DJ Controller for enjoying DJ on a computer and on an iPhone / iPad. The user can use either a computer or iPhone / iPad depending on the situation so DJing can be enjoyed in a variety of DJ scenes.

iPhone / iPad CONNECTION

The content of an iPhone / iPad can be easily used for DJ performances by connecting this unit and the iPhone / iPad with the cable included with the iPhone / iPad.

In addition, since the iPhone / iPad can be recharged even while DJing, DJ performances can be enjoyed without needing to worry about the remaining battery charge.

PULSE CONTROL

Stages DJ performance in animations with a fusion of sound and light. When a track is loaded, LED light flows toward the jog dial, staging so that the user knows at a glance that the track has been loaded. Also, the LED light rotates during the playback of a track so that the user can know at an instant that a track is playing.

Design

Achieves a flat, compact size that is easy to carry around, and does not take up space when installed, for a smart, casual design.

Uses a round layout letting first-time DJ users to enjoy DJ without feelings of difficulty and an aluminum panel on top that accentuates simplicity.

In addition, a blue LED is mounted on the JOG dial to realize a fusion of sound and light in the FX PULSE or other function, and this serves to stage the DJ performance feel, and the enjoyment of sound manipulation.

Compatibility with various DJ software programs

Since it is compatible with MIDI, a variety of DJ software can be used to perform hot cue, sampler, or other operations.

For the latest software support status, see the Pioneer DJ support site below.

<http://pioneerdj.com/support/>

What's in the box

- Operating Instructions (Quick Start Guide)
- AC adapter
- Power cord
- USB cable
- Warranty (for some regions)¹
- rekordbox dj license key card
- Virtual DJ LE 8 license key card

- ¹ The warranty is included for European region only.
- For the North American region, the corresponding information is provided on the last page of both the English and French versions of the "Operating Instructions (Quick Start Guide)".
 - For the Japanese region, the corresponding information is provided on the last page of the "Operating Instructions (Quick Start Guide)".

Caution

The license key cannot be reissued. Be careful not to lose it.

Part names and functions

Top panel of unit

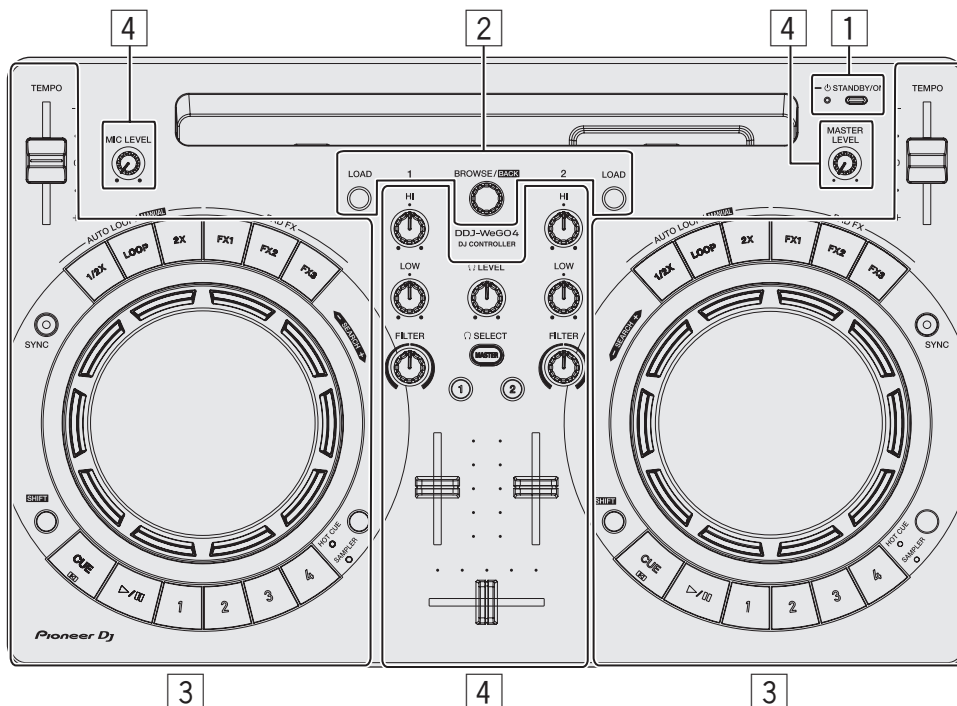

1 Power section

This switches this unit's power between on and standby.

2 Browser section

This selects the tracks to play and loads them into each deck.

3 Deck section

The deck section is used to control the two decks. There are controls and buttons for operating deck 1 on the left side of the controller, controls and buttons for operating deck 2 on the right side of the controller.

4 Mixer section

This controls level adjustment of each channel, track mixing, etc.

The functions of the buttons and controls are when combined with rekordbox dj or WeDJ.

For details on the functions when combined with djay 2, vjay, or Virtual DJ LE 8, see [DDJ-WeGO4] of the [DJ CONTROLLER] category from the [SOFTWARE INFORMATION] page of the Pioneer DJ site below.
<http://www.pioneerdj.com/en/support/software-information/>

2 STANDBY/ON button

- ❖ When unit power is on standby
 - Press: Turn on the power of this unit.
- ❖ When unit power is on
 - Press for over 1 second: Set this unit's power to the standby mode.

Browser section



1 LOAD button

Press:
Loads the selected tracks into the respective decks.

Press (twice):
Loads the tracks loaded in the deck on the opposite side into the deck whose [LOAD] button was pressed. When this is done while a track is playing, the track is played from the same position. (Instant Doubles) (rekordbox dj)

[SHIFT] + press:
Sorts the track list when one of the [LOAD] buttons is pressed. (rekordbox dj)

- The tracks are sorted by BPM on the channel 1 side and by artist on the channel 2 side.

2 Rotary selector

Turn:
Moves the cursor vertically. (rekordbox dj)

Power section

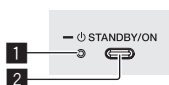

1 STANDBY/ON indicator

- Shows the unit power status.
- ❖ When red
The unit power is on standby.
 - ❖ When green
The unit power is on.

In the case of the top screen, switches to the browse screen. In the browse screen, moves the cursor vertically. (WeDJ)

Press:

Moves between the tree view and track list or opens a folder.

(rekordbox dj)

- When the playlist palette is displayed, the cursor moves between playlists in addition to the tree view and track list.
- The tree view, track list, and playlist palette are in the browse section of rekordbox dj. For details on the role of each of them, see the Operating Instructions of rekordbox.

Pressing the rotary selector moves to the next level of the browser screen. (WeDJ)

— Example: [Artist] > Artist list

[SHIFT] + press:

Moves between the tree view and track list or closes a folder.

(rekordbox dj)

Pressing the rotary selector moves to the previous level of the browser screen. (WeDJ)

— Example: [Artist] < Artist list

Deck section

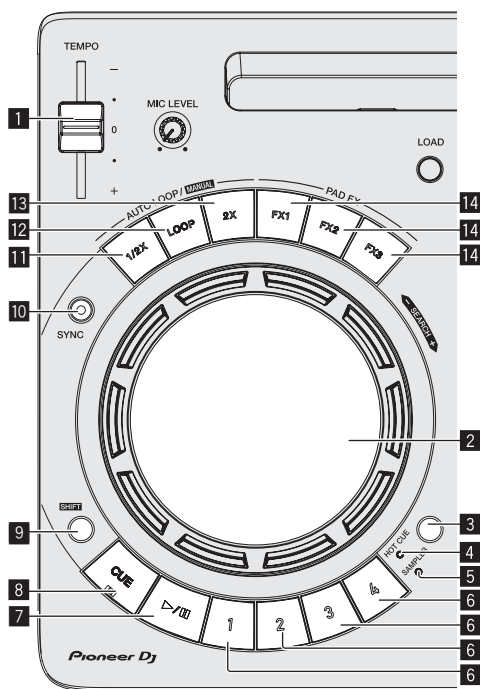

1 TEMPO slider

Adjusts the track playing speed.

2 Jog dial

Turn top:

Performs scratching operation.

Turn outer section:

The pitch bend operation (adjustment of the playing speed) is possible.

[SHIFT] + Turn top:

Skips the playback position.

3 HOT CUE/SAMPLER mode switching button

Switches the performance button mode to hot cue mode or sampler mode.

4 HOT CUE mode indicator

Lights up when the performance buttons are in hot cue mode.

5 SAMPLER mode indicator

Lights up when the performance buttons are in sampler mode.

6 Performance buttons

❖ When in hot cue mode

— Press:

Sets the hot cue point.

— [SHIFT] + press:

Delete the hot cue set for that button.

❖ When in sampler mode

— Press:

Plays the sampler slot.

— [SHIFT] + press:

Stops playback of the sampler slot. (rekordbox dj)

Plays a different type of sampler slot. (WeDJ)

7 PLAY/PAUSE ►/II button

Plays or pauses a track.

8 CUE button

Press:

Sets the cue point. Or moves to a cue point.

[SHIFT] + press:

Moves the playing position to the beginning of the track.

9 SHIFT button

When another button is pressed while pressing the [SHIFT] button, a different function is called out.

10 SYNC button

Press:

Synchronizes with the tempos (pitches) and beat grids of the deck set as the master for synchronization automatically. (rekordbox dj)

This enables automatically synchronizing with the tempos (pitches) and beat grids of the deck opposite to the pressed deck. (WeDJ)

[SHIFT] + press:

Sets the deck whose button is pressed as the master deck for synchronization. (rekordbox dj)

11 Loop half button

Press:

Set the width of loop playback interval to 1/2 times.

[SHIFT] + press:

Sets a loop in point.

12 Loop button

Press:

Turns auto beat loop on.

Turns loop playback off during loop playback.

[SHIFT] + press:

Sets a loop out point and starts loop playback.

13 Loop double button

Press:

Set the width of loop playback interval to 2 times.

❖ During loop playback

— [SHIFT] + press:

Cancels loop playback. (Loop Exit)

❖ After canceling loop playback

— [SHIFT] + press:

Resumes the loop playback that was set last time. (Reloop)

14 FX button

Press:

The pad FX is on while the button is pressed.

[SHIFT] + press:

A different type of pad FX is on while the button is pressed.

Mixer section

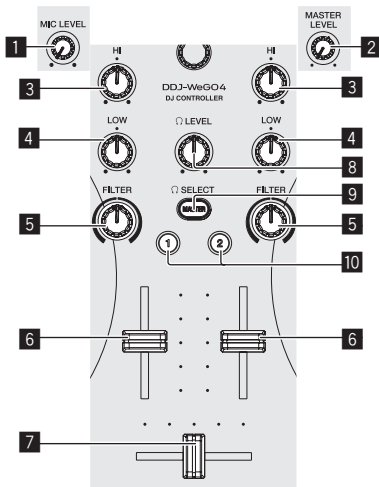

1 MIC LEVEL control

Adjusts the level of audio input to the [MIC] input terminals.

- When not using a microphone, set the volume to the minimum level.

2 MASTER LEVEL control

Adjusts the level of the audio output from the [MASTER] output terminals.

- This is not linked with [MASTER] of rekordbox dj.

3 EQ HI control

Adjusts the high range of the respective channels.

4 EQ LOW control

Adjusts the low range of the respective channels.

- With rekordbox dj and WeDJ, this can be switched to the adjustment function of the middle range in [Preferences] of the application.

5 FILTER control

Applies the filter effect for the respective channel.

The original sound is output when the control is at the center position.

Turn counterclockwise: Gradually descends the low-pass filter's cut-off frequency.

Turn clockwise: Gradually rises the high-pass filter's cutoff frequency.

- When using FILTER with rekordbox dj, display the CFX panel and then click the [FILTER] button to turn FILTER on.
- With rekordbox dj and WeDJ, this can be switched to the adjustment function of the low range in [Preferences] of the application.

6 Channel fader

Adjusts the level of audio signals output in each channel.

7 Crossfader

Switches the sound of the channels assigned to the left and right sides of the crossfader for output.

8 HEADPHONES LEVEL control

Adjusts the level of audio output from the [PHONES] output terminals.

9 HEADPHONES CUE MASTER selection button

Outputs the master sound from the headphones.

- When the button is pressed again, the output is canceled.

10 HEADPHONES CUE 1/2 selection button

Outputs the sound of the pressed channels from the headphones.

- When the button is pressed again, the output is canceled.

Cautions for using the iPhone / iPad stand



- This stand is exclusively for use with an iPhone / iPad. Do not place a tablet other than a supported model or a large device on the stand.
- Set the iPhone / iPad in the horizontal direction on the stand. It may be unstable if set in the vertical direction.
- Do not apply excessive force to the stand. Doing so may damage this unit.
- Please note that Pioneer will accept no responsibility whatsoever for damage to or malfunction of the device, injury, etc., due to the device falling, etc.
- Do not move the unit with an iPhone / iPad placed on the stand. The iPhone / iPad may fall off.
- If there is a cover on the iPhone / iPad, remove the cover before placing the iPhone / iPad on the stand. If the cover is left on, the iPhone / iPad may be unstable.

Rear panel

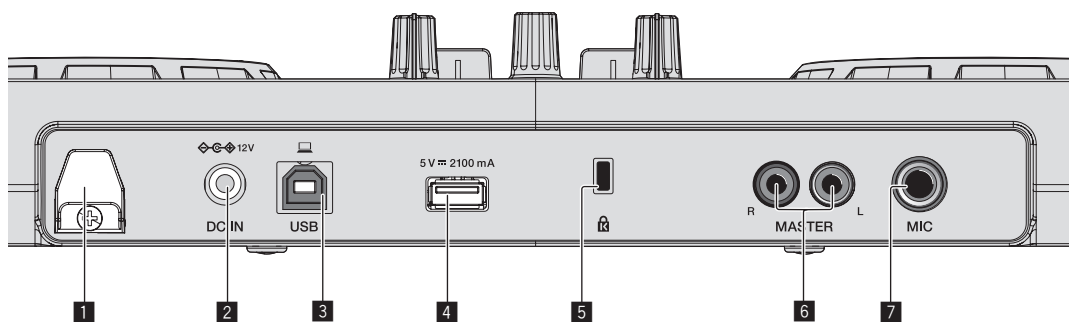

1 Cord hook

Secure the AC adapter's power cord and USB cable on this hook.

- This prevents the power cord and USB cable from being accidentally pulled and the plugs from being disconnected from the terminals.
- If the AC adapter's power cord or the USB cable is disconnected during operation, the sound may be interrupted or the unit may restart.

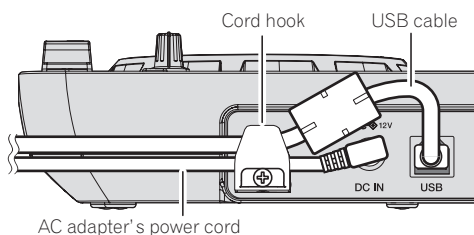

2 DC IN terminal

Connect the DC plug of the included AC adapter.

- Connect the power cord after all the connections between devices have been completed.
- Be sure to use the power cord and AC adapter included with this product.

3 USB-B terminal

Connect to a computer or Android device.

- Be sure to connect directly using the USB cable included with this product.

- A USB hub cannot be used.
- When connecting with an Android device, a separately sold USB conversion cable is required. Select a USB conversion cable matching the shape of the USB terminal of your Android device.
- The brightness of the buttons and JOG illumination that light is dimmed when running on USB bus power.

4 USB-A terminal

Connect to an iPhone / iPad.

- Be sure to connect directly using the cable included with the iPhone / iPad.
- A USB hub cannot be used.
- When connecting an iPhone / iPad, connect the AC adapter. This unit cannot run on USB bus power.
- This unit can recharge an iPhone / iPad using the cable included with the iPhone / iPad.
- An iPhone / iPad cannot be charged when the power of the iPhone / iPad is off or when there is no battery power remaining.

5 Kensington security slot

This hole is used to attach an anti-theft wire lock.

6 MASTER output terminals (RCA pin jacks)

Connect speakers with a built-in amplifier, power amplifier, etc.

- Unbalanced output is supported.

7 MIC input terminal (1/4" TS jack)

Connects a microphone here.

- Supports unbalanced input only.

Side panel

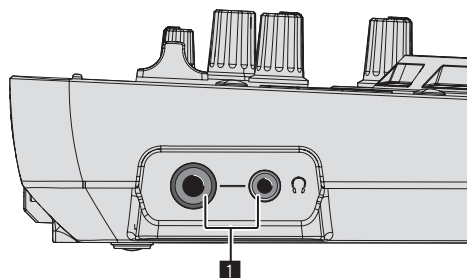

1 PHONES output terminals (1/4" stereo phone jack and 3.5 mm stereo mini jack)

Both stereo phone plugs (Ø 6.3 mm) and stereo mini phone plugs (Ø 3.5 mm) can be used.

- Connect stereo headphones with an impedance of 32Ω or higher. Headphones with an impedance less than 32Ω and mono headphones are not supported.
- Do not connect headphones simultaneously to the stereo phone jack and the stereo mini-phone jack.

Using WeDJ for iPhone / iPad

About WeDJ for iPhone / iPad

- WeDJ for iPhone / iPad is an application that enables DJ performances with an iPhone / iPad.
- WeDJ for iPhone / iPad can be purchased from the App Store.

System requirements

	WeDJ for iPad	WeDJ for iPhone
iOS	iOS 10, 9, 8	iOS 10, 9, 8
Compatible models	iPad Pro (9.7-inch), iPad Air 2, iPad Air, iPad mini 4, iPad mini 3, iPad mini 2	iPhone 7, iPhone 7 Plus, iPhone 6s, iPhone 6s Plus, iPhone 6, iPhone 6 Plus, iPhone SE, iPhone 5s

- For information on the latest system requirements, compatibility, and supported operating systems, see [DDJ-WeGO4] of the [DJ CONTROLLER] category from the [SOFTWARE INFORMATION] page of the Pioneer DJ support site below.
<http://www.pioneerdj.com/en/support/software-information/>
- There is no guarantee that operation will be possible on all iPhones and iPads meeting the above system requirements.
- Depending on the power-saving settings and other conditions of the iPhone or iPad, performance may be insufficient.
- Problems may occur with operation depending on the other software that you use.
- For the latest system requirements for WeDJ for iPhone / iPad, check the App Store.
- An Internet connection is required to access App Store.

Connections

1 Connect speakers with a built-in amplifier, a power amplifier, etc. to the [MASTER] output terminals of this unit.

- An audio cable (RCA) is not included with this product. Please provide it yourself separately.

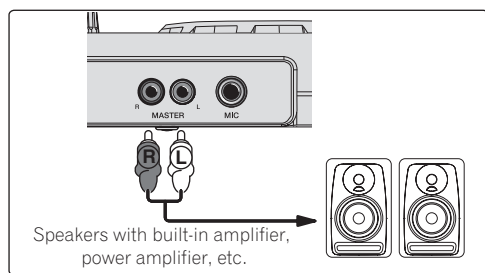

- For details on connecting the input/output terminals, see page 7.
- Set the volume of the device connected to the [MASTER] terminals (speakers with built-in amplifier, power amplifier, etc.) to an appropriate level. Note that the output sound may be loud if the volume is set too high.

2 Connect headphones to an [PHONES] output terminal of this unit.

- Connect stereo headphones with an impedance of 32 Ω or higher. Headphones with an impedance less than 32 Ω and mono headphones are not supported.
- Do not connect headphones simultaneously to the stereo phone jack and the stereo mini-phone jack.

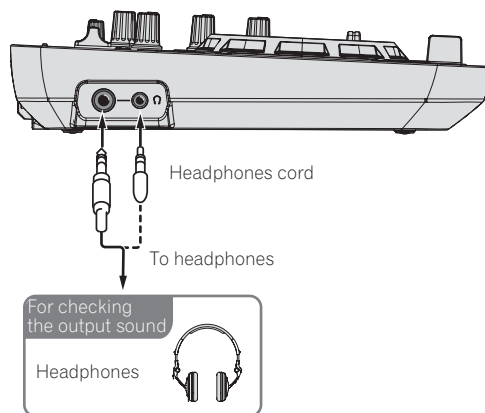

3 Connect this unit and the iPhone / iPad using the cable included with the iPhone / iPad.

- Be sure to connect directly using the cable included with the iPhone / iPad. A USB hub cannot be used.

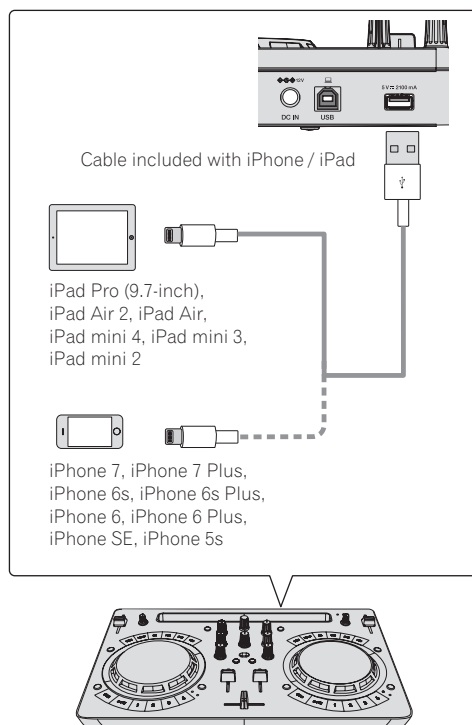

4 Connect the included DC plug of the AC adapter to this unit and then connect the power cord.

- Connect the power cord after all the connections between devices have been completed.
- Be sure to use the power cord and AC adapter included with this product.

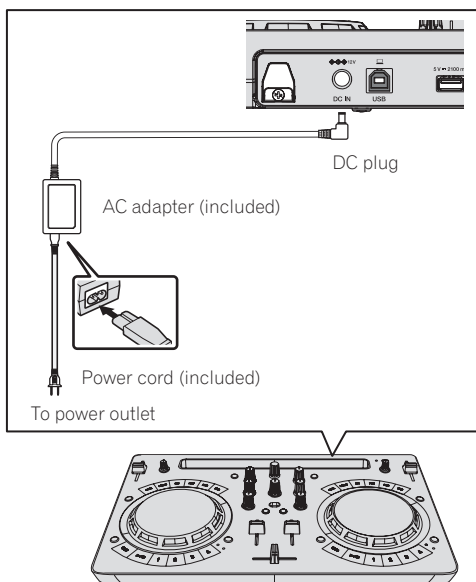

Start up the system.

- 1 Turn on the power of the iPhone / iPad.
- 2 Press the [STANDBY/ON] button of this unit to turn on the power of the unit.

After the startup illumination ends, the unit is ready for use.

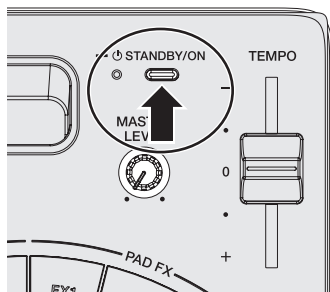

- 3 Turn on the power of the device (speakers with built-in amplifier, power amplifier, etc.) connected to the output terminals.
- 4 Launch WeDJ for iPhone / iPad.

Operation

Loading tracks into a deck

The following describes the procedure for loading tracks into deck 1 (left side) as an example.

- 1 Turn the rotary selector to switch to the browse screen.
- 2 Turn the rotary selector to move the cursor to [TRACKS] in the browse screen.
- 3 Press the rotary selector to move the cursor to the track list.
 - If the rotary selector is pressed while pressing the [SHIFT] button, the cursor moves to the [TAG LIST] / [TRACKS] / [PLAYLISTS] / [ARTISTS] / [ALBUMS] / [REC LIST] / [HISTORY] selection areas in the browse screen.

- 4 Turn the rotary selector to select a track in [TRACKS] and then press the [LOAD] button of deck 1 (left side).

The track is loaded into the deck.

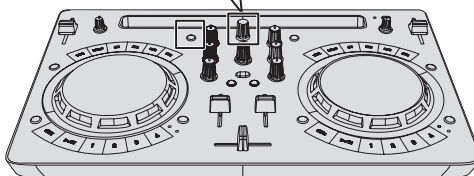
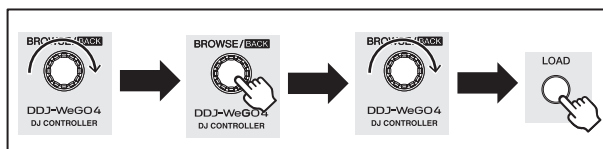

Playing a music file

The following describes the procedure for outputting the sound of deck 1 (left side) as an example.

- 1 Set the positions of the controls, etc., as shown below.

Names of controls, etc.	Position
EQ (HI, LOW) controls	Center
FILTER control	Center
Channel fader	Moved forward
MASTER LEVEL control	Turned fully counterclockwise
Crossfader	Center

- 2 Press the [PLAY/PAUSE▶/II] button to play the track.

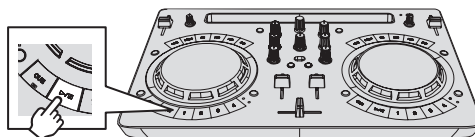

- 3 Move the channel fader away from you.

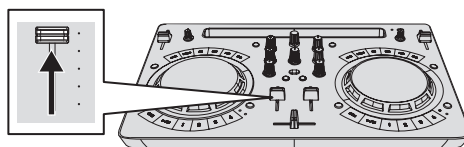

- 4 Turn the [MASTER LEVEL] control to adjust the audio level of the speakers.

Adjust the audio level output from the [MASTER] output terminals to an appropriate level.

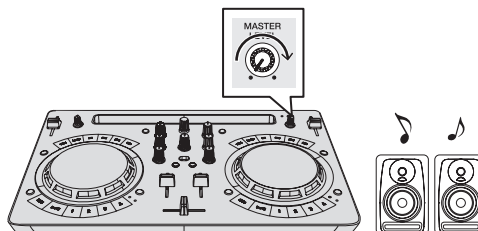

Sound is output from the speakers.

Monitoring sound with headphones

- 1 Set the positions of the controls, etc., as shown below.

Names of controls, etc.	Position
[HEADPHONES LEVEL] control	Turned fully counterclockwise

- 2 Press the [HEADPHONES SELECT 1] button.

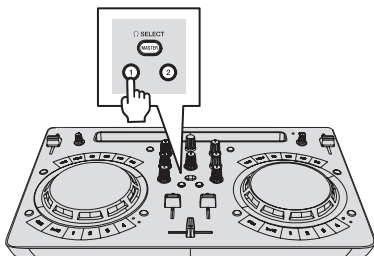

- 3 Turn the [HEADPHONES LEVEL] control.

Adjust the sound level output from the headphones to an appropriate level.

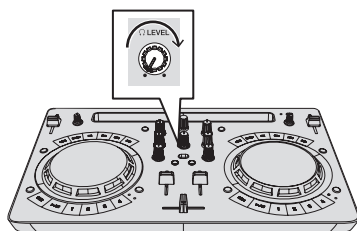

Inputting the sound of the microphone

The sound of the microphone connected to the [MIC] input terminal can be mixed.

- 1 Connect the microphone to the [MIC] input terminal.

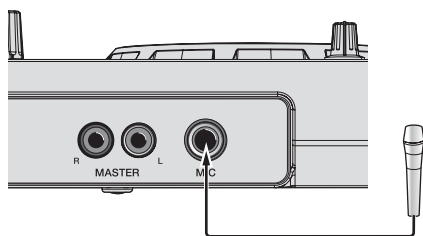

- 2 Turn the [MIC LEVEL] control to adjust the audio level of the microphone.

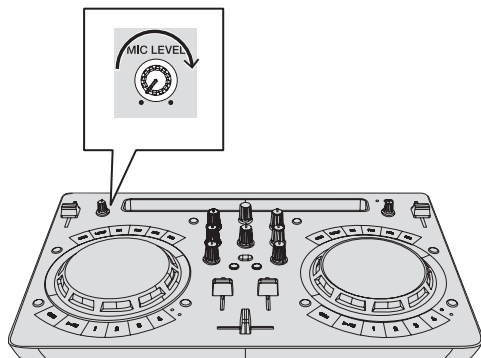

Quitting the system

- 1 Quit WeDJ for iPhone / iPad.
- 2 Press the [STANDBY/ON] button until the unit enters standby.

WeDJ Advanced Operation

For the detailed operating procedures, see the introduction video in WeDJ.

Using hot cues

Playback can be started instantaneously from the position at which a hot cue is set. In addition to hot cues, loops can be set and called out instantaneously.

- Up to four hot cue points can be set and saved per track.

❖ Setting and calling out a hot cue

- 1 When the [HOT CUE] indicator is off, press the [HOT CUE/SAMPLER] mode switching button.

The unit switches to the hot cue mode and the indicator lights.

- 2 Press a performance button to set a hot cue point during playback or pause.

Hot cue points are assigned to the respective performance buttons as shown below.

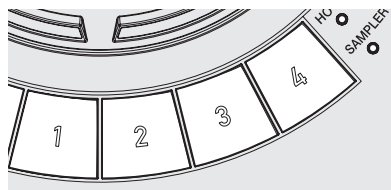

- [1] Hot cue A
- [2] Hot cue B
- [3] Hot cue C
- [4] Hot cue D

- 3 Press the performance button with the hot cue point set.

Playback starts from the hot cue point.

- A set hot cue point can be cleared by pressing a performance button while pressing the [SHIFT] button.

❖ Setting and calling out an auto beat loop

- 1 When the [HOT CUE] indicator is off, press the [HOT CUE/SAMPLER] mode switching button.

The unit switches to the hot cue mode and the indicator lights.

- 2 Press the loop half button or loop double button to set the length of the auto beat loop.

- 3 Press the loop button during playback.

The auto beat loop starts.

- 4 Press a performance button during auto beat loop playback to set the loop.

- 5 Press the performance button with the loop set.

Loop playback starts from the loop in point of the set loop.

- A set loop can be cleared by pressing a performance button while pressing the [SHIFT] button.

❖ Setting and calling out a manual loop

1 When the [HOT CUE] indicator is off, press the [HOT CUE/SAMPLER] mode switching button.

The unit switches to the hot cue mode and the indicator lights.

2 Press the loop half button while pressing the [SHIFT] button during playback and then press the loop button. Loop playback starts.

3 Press a performance button during loop playback to set the loop.

4 Press the performance button with the loop set.

Loop playback starts from the loop in point of the set loop.

- A set loop can be cleared by pressing a performance button while pressing the [SHIFT] button.

Using the sampler function

The tracks loaded in the sampler slots of the sampler can be played with the performance buttons.

❖ Using the performance buttons to play the sampler

1 When the [SAMPLER] indicator is off, press the [HOT CUE/SAMPLER] mode switching button.

The unit switches to the sampler mode and the indicator lights.

2 Move the [SAMPLER VOL] fader in WeDJ upward.

[SAMPLER VOL] is displayed if you press the [M] button.

3 Press a performance button.

The sound of the slot assigned to the button that was pressed is played.

- The first sampler bank is assigned to the respective button.

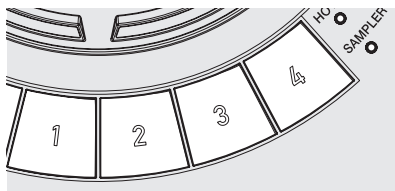

4 Press a performance button while pressing the [SHIFT] button.

The sound of the slot assigned to the button that was pressed is played.

- The second sampler bank is assigned to the respective button.

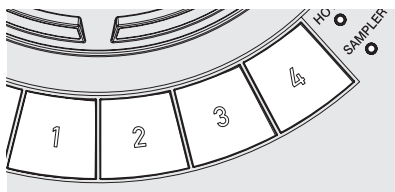

❖ Loading a sample sound source into a sampler slot

An internal sample sound source can be loaded from the sampler area of the WeDJ screen.

1 When the [SAMPLER] indicator is off, press the [HOT CUE/SAMPLER] mode switching button.

The unit switches to the sampler mode and the indicator lights.

2 Select the sampler pack.

Touch [▼] to select from the internal sampler pack list.

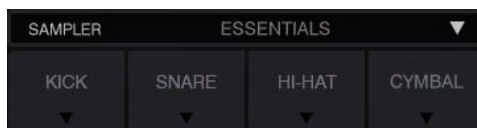

An internal sample sound source can also be loaded into each slot.

Using the pad FX

A wide range of effect performances are possible with just the simple operation of pressing and releasing buttons.

❖ Turning pad FX on using the [FX] button

1 Press and hold down the [FX] button or press and hold down the [FX] button while pressing the [SHIFT] button.

The effect turns on according to the effect assigned to the button and number of beats settings that was pressed.

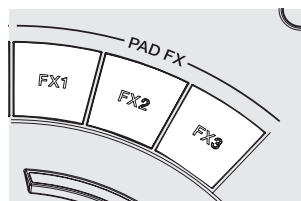

	Without [SHIFT]	With [SHIFT]
[FX 1]	Effect A	Effect B
[FX 2]	Effect A	Effect C
[FX 3]	Effect A	Release FX A

- The effects assigned to the [FX] buttons can be customized. (Customize the effects while this unit is in a connected state.)

2 Release your finger from the [FX] button.

The effect turns off.

❖ Customizing effects

Effects can be customized from the PAD FX area of the WeDJ screen.

Select an effect

Touch [▼] to select from the internal effect list.

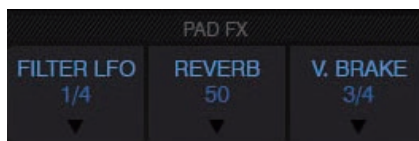

Using CFX

Effects can be obtained with just the simple operation of turning a control.

❖ Turning CFX on using the [FILTER] control

The effect is applied to the audio of the corresponding channel by turning the [FILTER] control.



❖ Customizing CFX

Effects can be customized from the CFX area of the WeDJ screen.

Select CFX.

Touch [▼] to select from the internal effect list.



- If the CFX area is not displayed, turn on [CFX] in the [Controller] item of [Settings] in WeDJ.

Using recording functions

WeDJ has recording functions and can record mixed sound.

1 Touch [RECORD] in the WeDJ screen to start recording.

2 Touch [RECORD] again to stop recording.

- When the recording completes, the file is automatically saved to [REC LIST].

Using djay 2 for iPhone / iPad, vjay for iPhone / iPad

Before using djay 2 for iPhone / iPad or vjay for iPhone / iPad

djay 2 for iPhone / iPad and vjay for iPhone / iPad can be purchased from App Store. Also check the latest system requirements.

- If you already have djay 2 for iPhone / iPad or vjay for iPhone / iPad, update it to the latest version.

Caution

djay 2 for iPhone / iPad and vjay for iPhone / iPad are products of algoridim GmbH. Pioneer DJ basically does not accept inquiries on how to operate djay 2 for iPhone / iPad and vjay for iPhone / iPad.

For the functions of djay 2 for iPhone / iPad and vjay for iPhone / iPad and the operating procedures, see [DDJ-WeGO4] of the [DJ CONTROLLER] category from the [SOFTWARE INFORMATION] page of the Pioneer DJ support site below.

<http://www.pioneerdj.com/en/support/software-information/>

System requirements

The system requirements for combining this unit and djay 2 for iPhone / iPad or vjay for iPhone / iPad are as follows.

For the latest system requirements for djay 2 for iPhone / iPad and vjay for iPhone / iPad, check the App Store.

	djay 2 for iPad	vjay for iPad	djay 2 for iPhone	vjay for iPhone
iOS	iOS 10, 9, 8			
Compatible models	iPad Pro (9.7-inch), iPad Air 2, iPad Air, iPad mini 4, iPad mini 3, iPad mini 2, iPad mini, iPad (4th generation), iPad (3rd generation), iPad2		iPhone 7, iPhone 7 plus, iPhone SE, iPhone 6s plus, iPhone 6s, iPhone 6 plus, iPhone 6, iPhone 5s, iPhone 5c, iPhone 5, iPhone 4s, iPod touch (6th generation), iPod touch (5th generation)	

- For information on the latest system requirements, compatibility, and supported operating systems, see [DDJ-WeGO4] of the [DJ CONTROLLER] category from the [SOFTWARE INFORMATION] page of the Pioneer DJ support site below.
<http://www.pioneerdj.com/en/support/software-information/>
- Operation is not guaranteed on all iPhones and iPads, even those meeting the system requirements described above.
- Depending on the power-saving settings and other conditions of the iPad or iPhone, performance may be insufficient.
- Problems may occur with operation depending on the other software that you use.
- An Internet connection is required to access App Store.

Connections

1 Connect speakers with a built-in amplifier, a power amplifier, etc. to the [MASTER] output terminals of this unit.

- An audio cable (RCA) is not included with this product. Please provide it yourself separately.

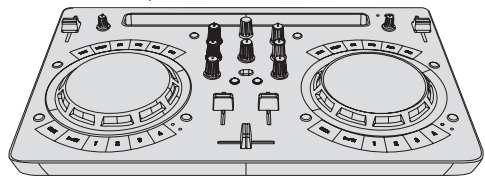
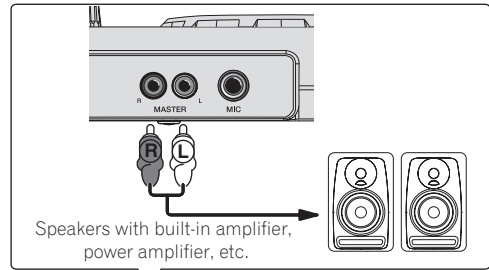

- For details on connecting the input/output terminals, see page 7.
- Set the volume of the device connected to the [MASTER] terminals (speakers with built-in amplifier, power amplifier, etc.) to an appropriate level. Note that the output sound may be loud if the volume is set too high.

2 Connect headphones to an [PHONES] output terminal of this unit.

- Connect stereo headphones with an impedance of 32 Ω or higher. Headphones with an impedance less than 32 Ω and mono headphones are not supported.
- Do not connect headphones simultaneously to the stereo phone jack and the stereo mini-phone jack.

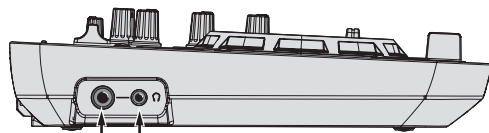

Headphones cord

To headphones



3 Connect this unit and the iPhone / iPad using the cable included with the iPhone / iPad.

- Be sure to connect directly using the cable included with the iPhone / iPad. A USB hub cannot be used.

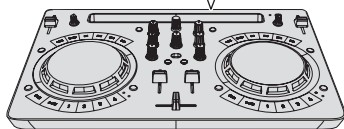
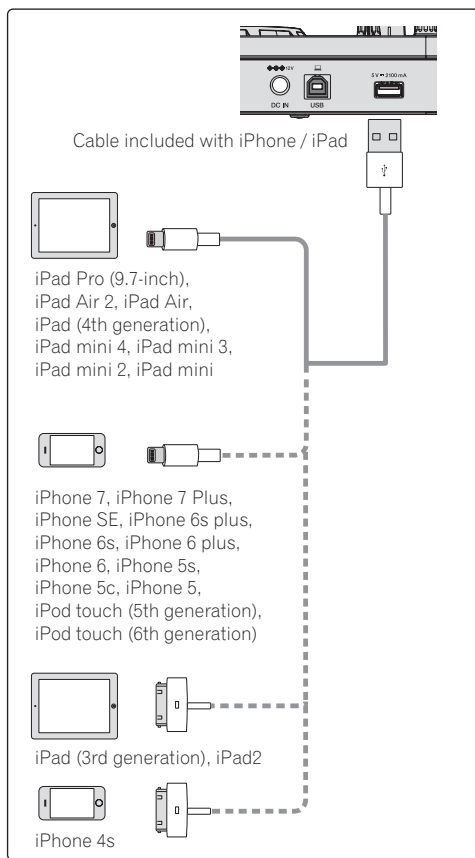

4 Connect the included DC plug of the AC adapter to this unit and then connect the power cord.

- Connect the power cord after all the connections between devices have been completed.
- Be sure to use the power cord and AC adapter included with this product.

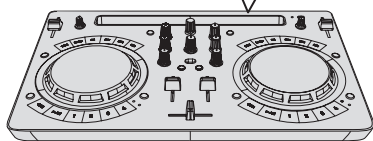
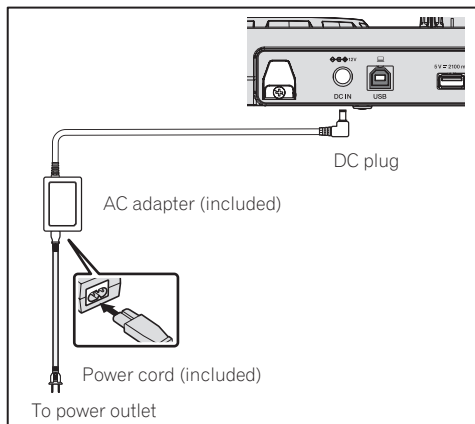

Start up the system.

- 1 Turn on the power of the iPhone / iPad.**
- 2 Press the [STANDBY/ON] button of this unit to turn on the power of the unit.**

After the startup illumination ends, the unit is ready for use.

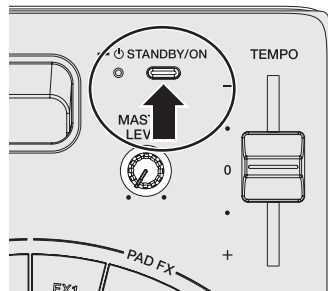

- 3 Turn on the power of the device (speakers with built-in amplifier, power amplifier, etc.) connected to the output terminals.**

- 4 Start djay 2 for iPhone / iPad or vjay for iPhone / iPad**
The Pioneer DJ logo appears. The following is a display example of djay 2 for iPad.

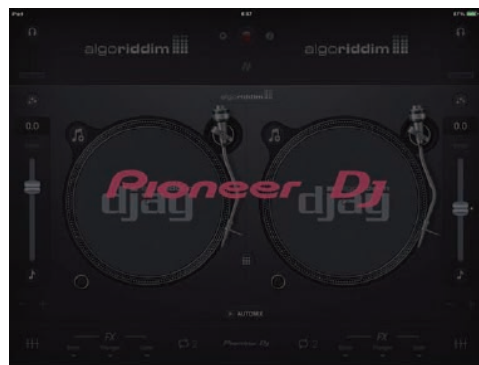

Caution

If the screen above does not appear even after waiting a while, disconnect the iPhone / iPad connection cable connector inserted in the iPhone or iPad and then repeat the procedure from step 3 of *Connections* again.

If the screen above still does not appear, restart the iPhone or iPad after performing the procedure up to step 2 of *Start up the system*, and then perform step 3 of *Start up the system*.

Operation

Loading tracks into a deck

The following describes the procedure for loading tracks into deck 1 (left side) as an example.

- Turn the rotary selector to select a track in [Musidlibrary] and then press the [LOAD] button of deck 1 (left side).**

The track is loaded into the deck.

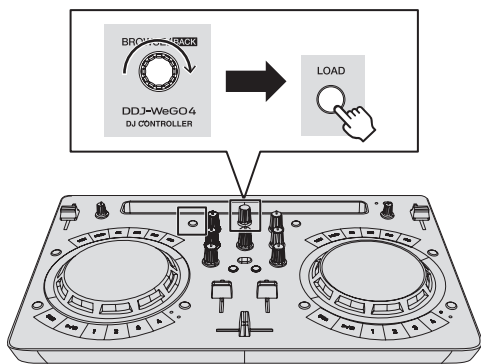

Playing a music file

The following describes the procedure for outputting the sound of deck 1 (left side) as an example.

- 1 Set the positions of the controls, etc., as shown below.

Names of controls, etc.	Position
EQ (HI, LOW) controls	Center
FILTER control	Center
Channel fader	Moved forward
MASTER LEVEL control	Turned fully counterclockwise
Crossfader	Center

- 2 Press the [PLAY/PAUSE▶/II] button to play the track.

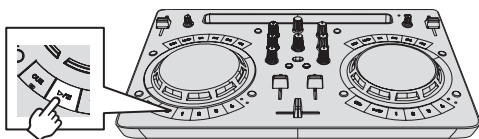

- 3 Move the channel fader away from you.

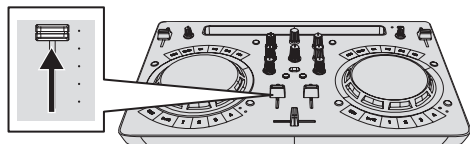

- 4 Turn the [MASTER LEVEL] control to adjust the audio level of the speakers.

Adjust the audio level output from the [MASTER] output terminals to an appropriate level.

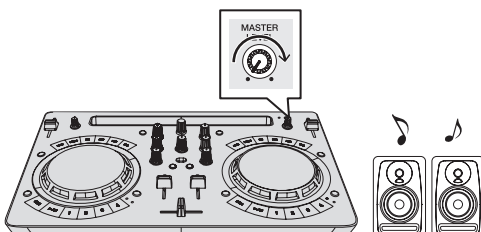

Sound is output from the speakers.

Monitoring sound with headphones

- 1 Set the positions of the controls, etc., as shown below.

Names of controls, etc.	Position
[HEADPHONES LEVEL] control	Turned fully counterclockwise

- 2 Press the [HEADPHONES SELECT 1] button.

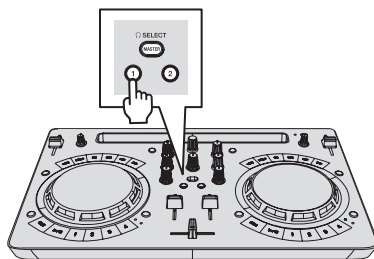

- 3 Turn the [HEADPHONES LEVEL] control.

Adjust the sound level output from the headphones to an appropriate level.

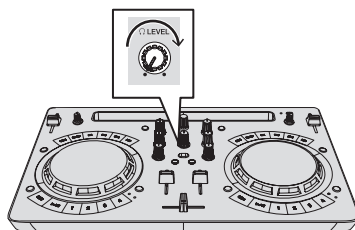

Inputting the sound of the microphone

The sound of the microphone connected to the [MIC] input terminal can be mixed.

- 1 Connect the microphone to the [MIC] input terminal.

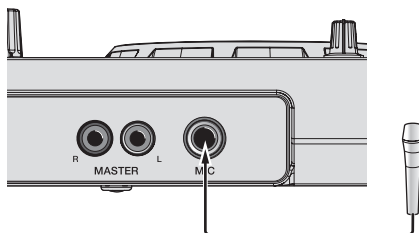

- 2 Turn the [MIC LEVEL] control to adjust the audio level of the microphone.

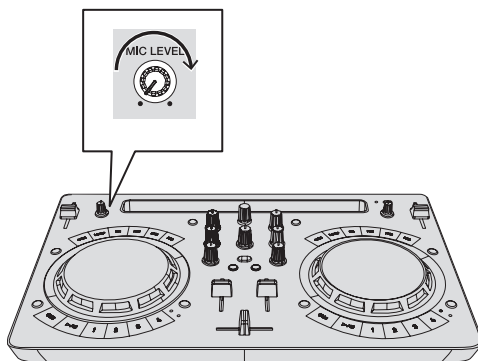

Quitting the system

- 1 Quit dJAY 2 for iPhone / iPad or vJAY for iPhone / iPad.
- 2 Press the [STANDBY/ON] button until the unit enters standby.

Using djay 2 for Android

Before using djay 2 for Android

djay 2 for Android can be purchased from Google Play. Also check the latest system requirements.

- If you already have djay 2 for Android, update it to the latest version.

Caution

djay 2 for Android is a product of algoriddim GmbH. Pioneer DJ basically does not accept inquiries on how to operate djay 2 for Android.

For the functions and operating procedures of djay 2 for Android, see [DDJ-WeGO4] of the [DJ CONTROLLER] category from the [SOFTWARE INFORMATION] page of the Pioneer DJ support site below.

<http://www.pioneerdj.com/en/support/software-information/>

System requirements

Android version	6.0, 5.1, 5.0, 4.4
Cable	A USB conversion cable (sold separately) is required.
Internet connection	An Internet connection is required to access Google Play.
Others	Your Android device must support the USB host mode.

- For information on the latest system requirements, compatibility, and supported operating systems, see [DDJ-WeGO4] of the [DJ CONTROLLER] category from the [SOFTWARE INFORMATION] page of the Pioneer DJ support site below.
<http://www.pioneerdj.com/en/support/software-information/>
- There is no guarantee that operation will be possible on all Android devices.
- The cable included with the Android device cannot be used.
- Charging an Android device is not possible.

Connections

When the version of your Android device is 6.0, 5.1, or 5.0

1 Connect speakers with a built-in amplifier, a power amplifier, etc. to the [MASTER] output terminals of this unit.

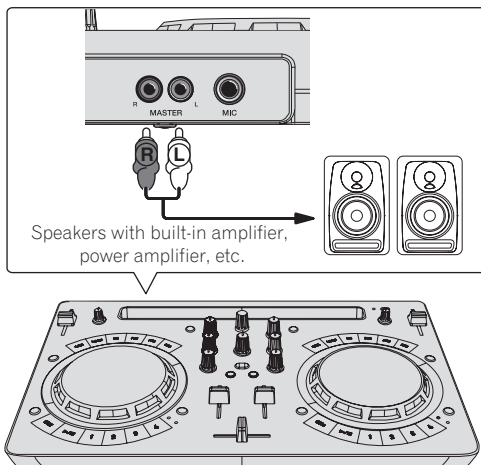

2 Connect headphones to an [PHONES] output terminal of this unit.

- Connect stereo headphones with an impedance of 32 Ω or higher. Headphones with an impedance less than 32 Ω and mono headphones are not supported.
- Do not connect headphones simultaneously to the stereo phone jack and the stereo mini-phone jack.

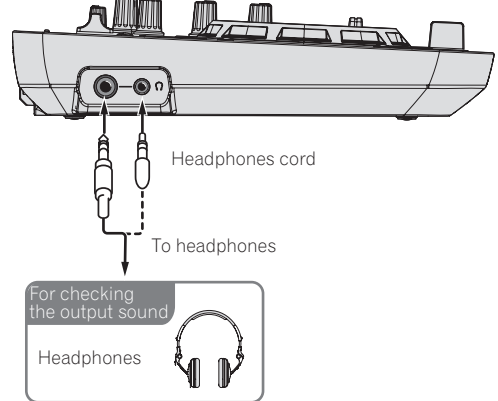

3 Connect this unit and the USB conversion cable (sold separately) with the included USB cable.

Select a USB conversion cable matching the shape of the USB terminal of your Android device.

- Be sure to connect directly using the USB cable included with this product. A USB hub cannot be used.
- The power cable included with the Android device cannot be connected to the [USB-A] terminal of this unit.

Shape of terminal of Android device	Shape of conversion cable connectors
USB micro A terminal	USB micro A (male) to USB A (female)
USB micro B terminal	USB micro B (male) to USB A (female)
USB Type-C terminal	USB Type-C (male) to USB A (female)

4 Connect the USB conversion cable to your Android device.

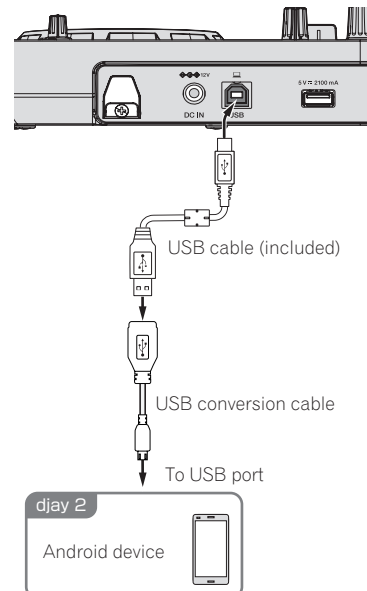

5 Connect the included DC plug of the AC adapter to this unit and then connect the power cord.

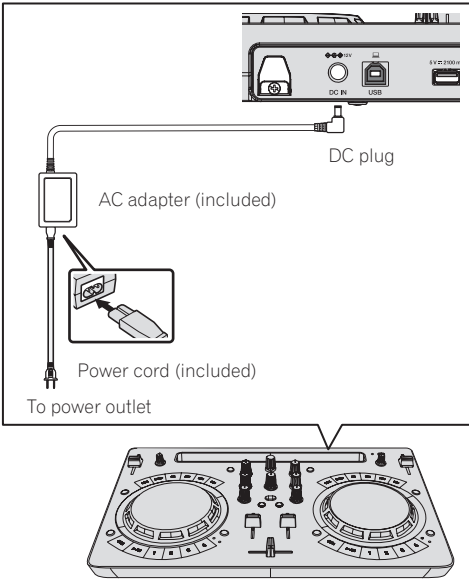

When the version of your Android device is 4.4

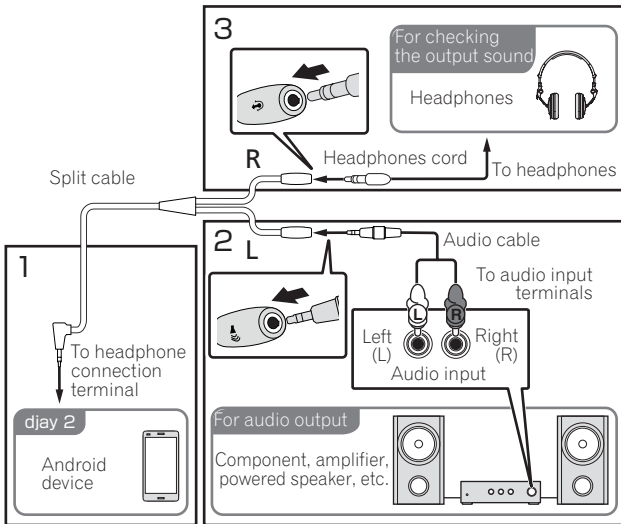

- 1 Connect a split cable (sold separately) to the headphones terminal of the Android device.**
A split cable is a cable for splitting the audio output from the stereo headphones jack into an L channel and R channel.
- 2 Use a 3.5 mm stereo mini jack (male) to RCA male conversion cable (sold separately) to connect speakers with a built-in amplifier or a powered amplifier to the L channel of the split cable.**
The [MASTER] output terminals of this unit cannot be used.
- 3 Connect headphones to the R channel of the split cable.**
The [PHONES] output terminals of this unit cannot be used.

4 Connect this unit and the USB conversion cable (sold separately) with the included USB cable.

Select a USB conversion cable matching the shape of the USB terminal of your Android device.

- Be sure to connect directly using the USB cable included with this product. A USB hub cannot be used.
- The power cable included with the Android device cannot be connected to the [USB-A] terminal of this unit.

Shape of terminal of Android device	Shape of conversion cable connectors
USB micro A terminal	USB micro A (male) to USB A (female)
USB micro B terminal	USB micro B (male) to USB A (female)
USB Type-C terminal	USB Type-C (male) to USB A (female)

5 Connect the USB conversion cable to your Android device.

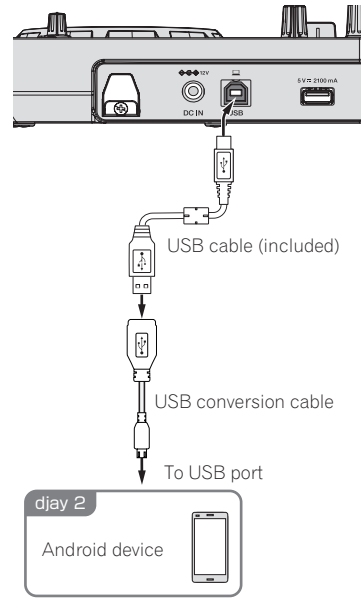

6 Connect the included DC plug of the AC adapter to this unit and then connect the power cord.

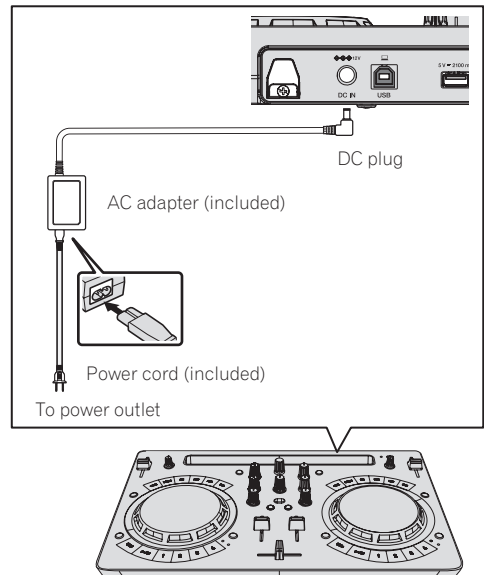

Start up the system

- 1 Turn on the power of the Android device.
- 2 Press the [STANDBY/ON] button of this unit to turn on the power of the unit.

After the startup illumination ends, the unit is ready for use.

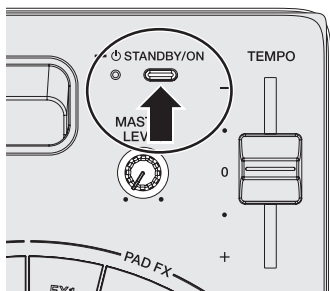

- 3 Turn on the power of the peripheral device (speakers with built-in amplifier, power amplifier, etc.).

- 4 Launch djay 2 for Android.

The Pioneer DJ logo appears.

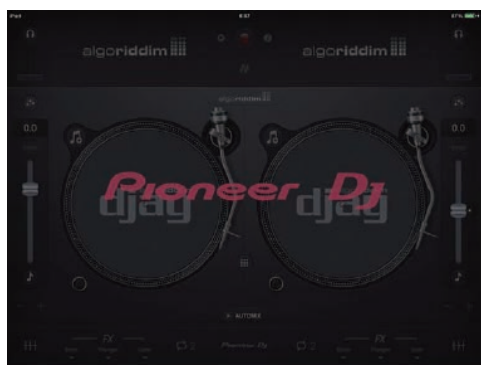

- If the Pioneer DJ logo is not displayed, disconnect the USB conversion cable from the USB terminal of your Android device and then reconnect it.

Checking the audio device settings (only when Android 4.4)

- 1 Tap [⚙️].



- 2 Turn [Sprit output] on.

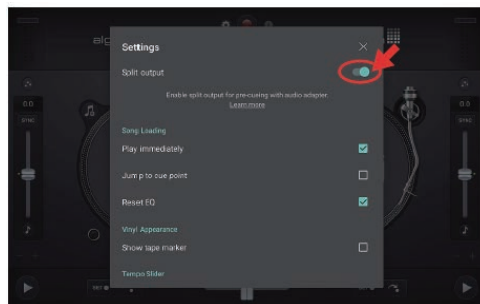

- 3 Tap [X] at the top right of the screen to exit the audio device settings.

Operation

Loading tracks into a deck

The following describes the procedure for loading tracks into deck 1 (left side) as an example.

- 1 Tap the [L1] of djay 2 for Android and then tap the [My Music] button.
 - [Musiclibrary] appears.

- 2 Tap the track you wish to load.

The track is loaded into the deck.

Playing a music file

- If the sound becomes distorted or playback becomes unstable when the tempo of a track has been adjusted with the key lock on, turn the key lock off.

The following describes the procedure for outputting the sound of deck 1 (left side) as an example.

- 1 Set the positions of the controls, etc., as shown below.

Names of controls, etc.	Position
EQ (HI, LOW) controls	Center
FILTER control	Center
Channel fader	Moved forward
MASTER LEVEL control	Turned fully counterclockwise
Crossfader	Center

- 2 Press the [PLAY/PAUSE▶/||] button to play the track.

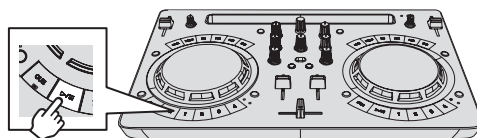

- 3 Move the channel fader away from you.

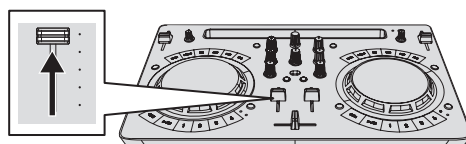

4 Turn the [MASTER LEVEL] control to adjust the audio level of the speakers (only when Android 6.0, 5.1, or 5.0).

Adjust the audio level output from the [MASTER] output terminals to an appropriate level.

- If sound is not output from the [MASTER] output terminals or the level of the output sound is low, increase the volume of the Android device.

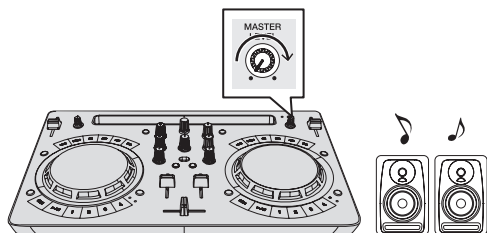

Sound is output from the speakers.

Monitoring sound with headphones (only when Android 6.0, 5.1, or 5.0)

1 Set the positions of the controls, etc., as shown below.

Names of controls, etc.	Position
[HEADPHONES LEVEL] control	Turned fully counterclockwise

2 Set the crossfader to the position of the deck 2 side (right side).

The headphone monitor of the deck 1 side (left side) turns on.

- dJAY 2 for Android turns on the headphone monitor of the deck on the side opposite to the position of the crossfader.

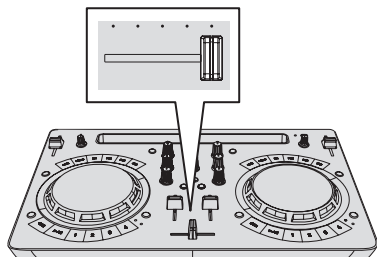

3 Turn the [HEADPHONES LEVEL] control.

Adjust the sound level output from the headphones to an appropriate level.

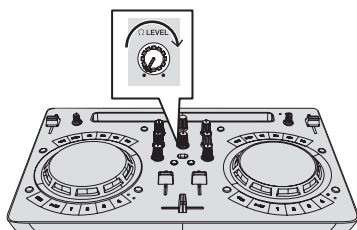

Inputting microphone sound (only when Android 6.0, 5.1, or 5.0)

The sound of the microphone connected to the [MIC] input terminal can be mixed.

1 Connect the microphone to the [MIC] input terminal.

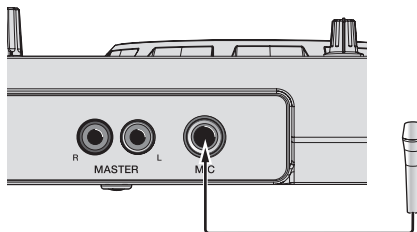

2 Turn the [MIC LEVEL] control to adjust the audio level of the microphone.

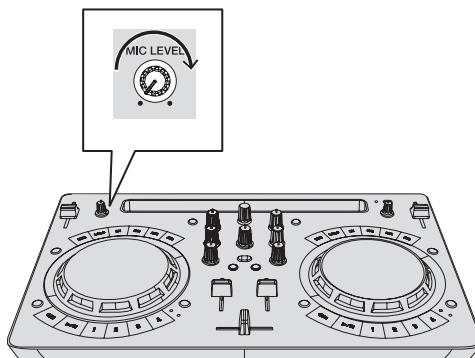

Quitting the system

1 Quit dJAY 2 for Android.

2 Press the [STANDBY/ON] button until the unit enters standby.

Using rekordbox

Viewing the manuals

Various instructions are sometimes provided as files in PDF format. Adobe® Reader® must be installed in order to view PDF format files.

Viewing the Operating Instructions of rekordbox

1 Launch a web browser on the computer and access the rekordbox product site below.

<http://rekordbox.com/>

2 Click [Support].

3 Click [Manual].

4 Click the required language of the manual.

- For inquiries on rekordbox, see the rekordbox product site indicated above.

About rekordbox

- rekordbox is a composite software that enables track management and DJ performances.
- The DJ performance function of rekordbox is called rekordbox dj. Enter the license key shown on the rekordbox dj license key card included with this product to use rekordbox dj.

Minimum operating environment

Supported operating systems	CPU and required memory
Mac: macOS Sierra 10.12, OS X 10.11/10.10/10.9 (latest update)	Intel® processor Core™ i3/i5/i7, Intel® processor Core™ 2 Duo 4 GB or more of RAM
Windows: 32-bit version or 64-bit version of Windows 10/Windows 8.1/Windows 7 (latest service pack)	Intel® processor Core™ i3/i5/i7, Intel® processor Core™ 2 Duo 4 GB or more of RAM
Others	
USB port	A USB 2.0 port is required to connect the computer with this unit.
Display resolution	Resolution of 1 280 x 768 or greater
Internet connection	An Internet connection is required for registering the rekordbox user account and downloading the software.

- For information on the latest system requirements, compatibility, and supported operating systems of rekordbox, see [System Requirements] on the rekordbox product site below.
<http://rekordbox.com/>
- Operation is not guaranteed on all computers, even if all the required operating environment conditions indicated here are fulfilled.
- Depending on the computer's power-saving settings, etc., the CPU and hard disk may not provide sufficient processing capabilities. For notebook computers in particular, make sure the computer is in the proper conditions to provide constant high performance (for example by keeping the AC power connected) when using rekordbox.
- Use of the Internet requires a separate contract with a provider offering Internet services and payment of provider fees.
- Use the latest version/service pack of the operating system.

Install rekordbox

Before installing rekordbox

If this is your first time to use rekordbox or if you are using rekordbox 3 or earlier, follow this procedure to install the software.

If you have already installed rekordbox 4, update it to the latest version.

The rekordbox software is not included.

Access the rekordbox product site and download the software.
<http://rekordbox.com/>

- The user is responsible for preparing the computer, network devices, and other elements of the Internet usage environment required for a connection to the Internet.
- If you are already using rekordbox4, rekordbox dj can be used by updating the software to the latest version.

Obtaining the rekordbox software

1 Access the rekordbox product site.

<https://rekordbox.com/en/store/>

- The page content is subject to change without notice.

2 Check the Get Started guide and then click [Free To Download].



3 Carefully read the terms of the software license agreement and select the [Agree] check box if you agree.

When you select the check box, [Download] becomes clickable.

4 Click [Download].

Downloading of rekordbox starts.

Installing the rekordbox software

The installation procedure depends on the operating system (OS) on the computer you are using.

Do not connect this unit and the computer until installation is completed.

- If any other programs are running on the computer, quit them.

❖ Installation Procedure (Mac)

1 Unzip the downloaded rekordbox software file.

2 Double-click the unzipped software file to launch the installer.

3 Read the terms of the license agreement carefully, and if you agree, click [Agree].

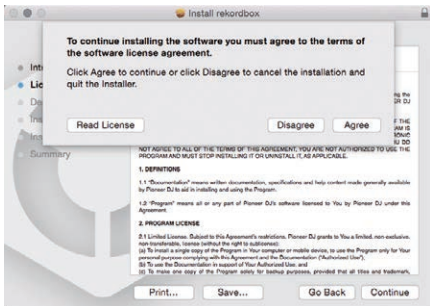

- If you do not agree to the contents of the license agreement, click [Disagree] to quit installation.

4 If the installation completion screen appears, click [Close] to close the rekordbox installer.

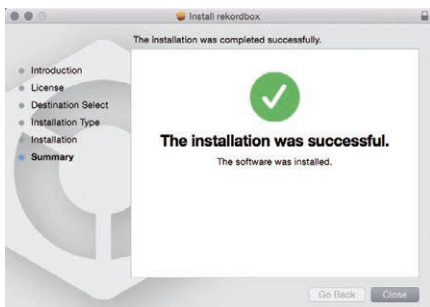

❖ Installation Procedure (Windows)

- Log on as the user which was set as the computer's administrator before installing.

- 1 Unzip the downloaded rekordbox software file.**
- 2 Double-click the unzipped software file to launch the installer.**
- 3 Read the terms of the license agreement carefully, and if you agree, select [Agree], then click [Next].**

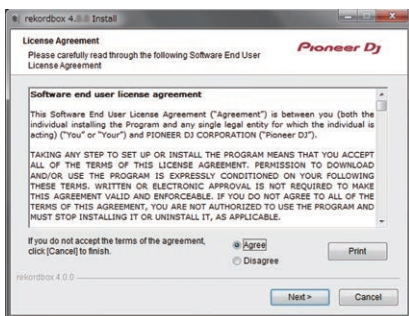

- If you do not agree to the contents of the license agreement, click [Cancel] to quit installation.
- After the installation destination is specified, the installation starts. The message of successful installation appears once installation is completed.

4 Click [Finish] to quit the rekordbox installer.

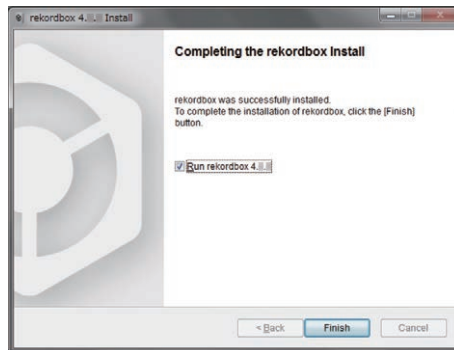

The installation is now complete.

Connections

1 Connect speakers with a built-in amplifier, a power amplifier, etc. to the [MASTER] output terminals of this unit.

- An audio cable (RCA) is not included with this product. Please provide it yourself separately.

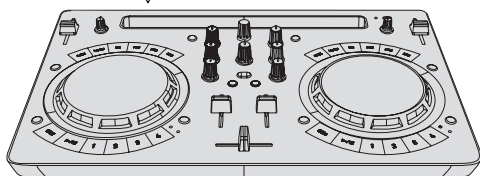
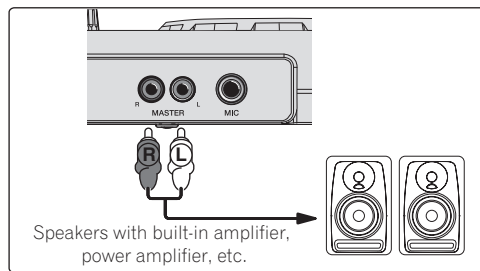

- For details on connecting the input/output terminals, see page 7.
- Set the volume of the device connected to the [MASTER] terminals (speakers with built-in amplifier, power amplifier, etc.) to an appropriate level. Note that the output sound may be loud if the volume is set too high.

2 Connect headphones to an [PHONES] output terminal of this unit.

- Connect stereo headphones with an impedance of 32 Ω or higher. Headphones with an impedance less than 32 Ω and mono headphones are not supported.
- Do not connect headphones simultaneously to the stereo phone jack and the stereo mini-phone jack.

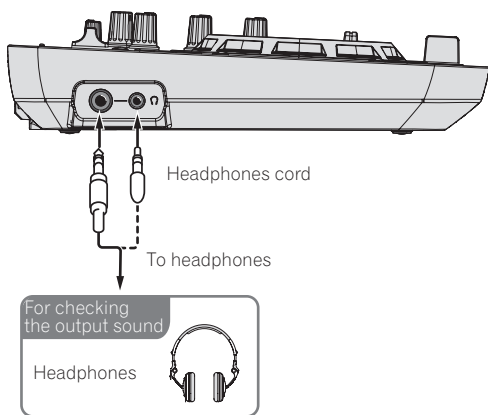

3 Connect this unit to your computer via a USB cable.

- Be sure to connect directly using the USB cable included with this product. A USB hub cannot be used.

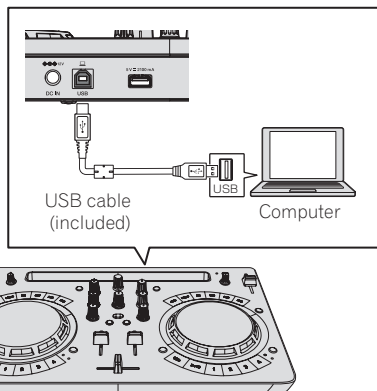

4 Connect the included DC plug of the AC adapter to this unit and then connect the power cord.

- Connect the power cord after all the connections between devices have been completed.
- Connection is not necessary when operating with bus power supplied from a USB port of the computer.
- Be sure to use the power cord and AC adapter included with this product.

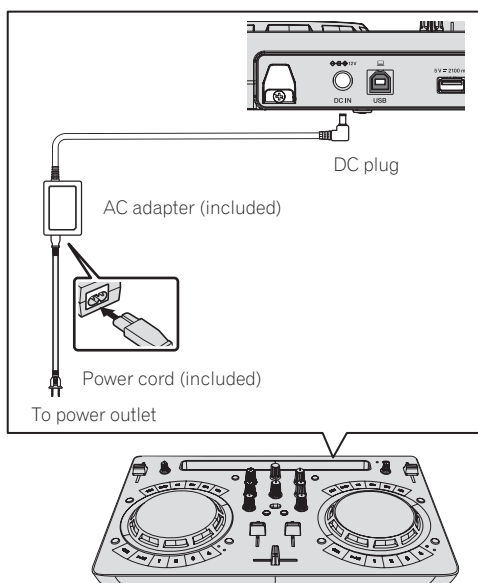

Start up the system

Cautions for people using Windows

When you connect this unit to a computer for the first time or connect it to a different USB terminal, the [Installing device driver software] alert may appear. If it appears, wait until the installation finishes.

1 Turn on the computer's power.

2 Press the [STANDBY/ON] button of this unit to turn on the power of the unit.

After the startup illumination ends, the unit is ready for use.

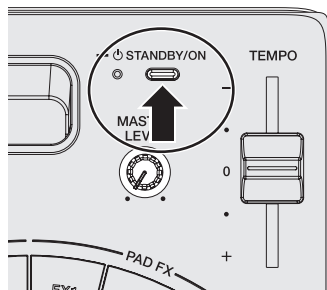

3 Turn on the power of the device (speakers with built-in amplifier, power amplifier, etc.) connected to the output terminals.

4 Launching rekordbox

This manual consists mainly of explanations of functions of this unit as hardware. For detailed instructions on operating rekordbox dj, see the rekordbox software's manual.

Click the [rekordbox] icon.

- For macOS Sierra 10.12 and OS X 10.11/10.10/10.9
Open the [Application] folder in Finder and then double-click the [rekordbox] icon in the [rekordbox4] folder.
- For Windows 10/8.1
From [Apps view], click the [rekordbox] icon.
- For Windows 7
From the Windows [Start] menu, click the [rekordbox] icon under [All Programs] > [Pioneer] > [rekordbox X.X.X].

Preparing rekordbox

- This procedure is required only at the first startup.

Enter the account information

If you already have an account, enter the account information and then click [Setup].

If you do not have an account, click [Create an account] to go to the web page for creating an account and then create an account.

- For details on the account creation procedure, access the rekordbox product site below and see the rekordbox Operating Instructions in [Support].
<http://rekordbox.com/>

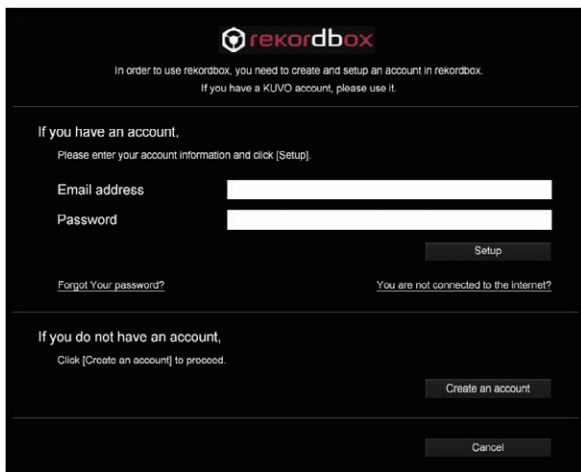

Select the usage method

Click the [DJ performance] icon.

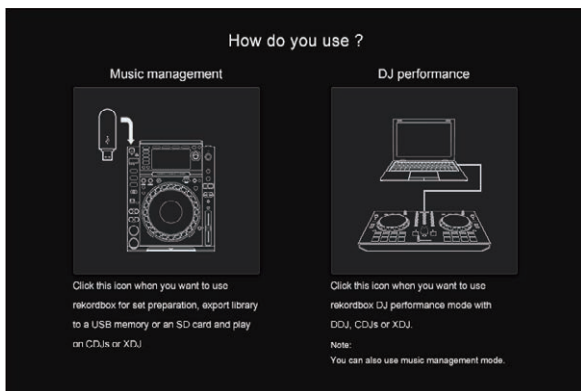

Enter the license key and activate the software

Enter the license key shown on the rekordbox dj license key card included with this product and activate the software following the instructions on the screen.

- There is no need for this product's users to purchase the rekordbox dj license key separately.
- For details on the activation work procedure, access the rekordbox product site below and see the rekordbox operating instructions in [Support].
<http://rekordbox.com/>

Installing the driver software

The audio driver software is an exclusive driver for outputting audio signals from a computer from the unit.
There is no need to install the driver software when using Mac.
Proceed to *Confirm the sending of rekordbox customer usage conditions*.

1 Disconnect the USB cable connecting this unit to the computer.

2 Select [DDJ-WeGO4] from the pull-down menu and click [Install] in the audio driver installation screen.

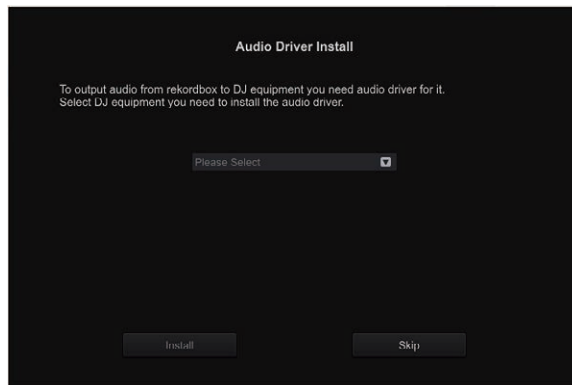

- If [Skip] is selected, the audio driver is not installed.

To install the audio driver later, select "DDJ_WeGO4_Driver_X.XXX.exe" in the procedure of [Preferences] > [Audio] > [Audio] > [Driver] in rekordbox dj and then perform the installation.

❖ Installation procedure (Windows)

Do not connect this unit and the computer until installation is completed.

- Log on as the user which was set as the computer's administrator before installing.
- If any other programs are running on the computer, quit them.

1 Select the language to use and then click [OK].

2 Read the *Software end user license agreement* carefully, check the [Agree] box if you agree to the terms of the *Software end user license agreement*, and then click [Install].

If you do not consent to the provisions of the *Software end user license agreement*, click [Cancel] and stop installation.

3 Proceed with installation according to the instructions on the screen.

If [Windows Security] appears on the screen while the installation is in progress, click [Install this driver software anyway] and continue with the installation.

When the installation program is completed, a completion message appears.

4 Connect this unit to your computer via a USB cable.

Confirm the sending of rekordbox customer usage conditions

If you wish to cooperate in the sending of customer usage conditions for the purpose of improving the quality and specifications of rekordbox, click [Yes], and click [No] if you not wish to send them.

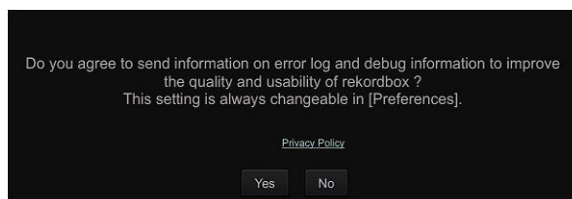

Set the audio

Start rekordbox to display **[Select Speaker]** while this unit is connected. Select one of the options to match your audio environment and then click **[OK]**.

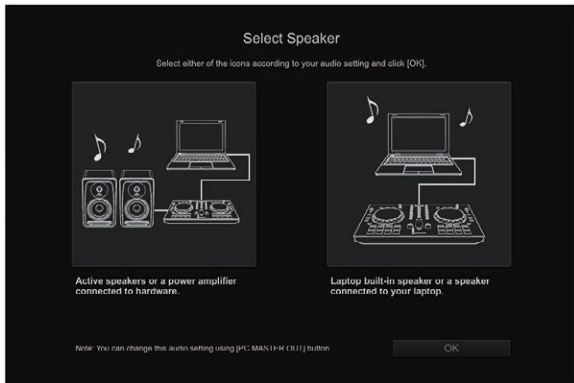

Adding track files to [Collection]

[Collection] is a screen for displaying a list of the track files managed by rekordbox.

Registering the track files on the computer as the music collection of rekordbox and then analyzing them enables those tracks to be used with rekordbox.

1 Click **[Collection]** in the tree view.

A list of the tracks registered in **[Collection]** is displayed.

2 Open Finder or Windows Explorer, then drag and drop track files or folders including track files to the track list.

The track files are added to **[Collection]**, and the waveform information analysis of the track files starts. Wait until the analysis of all the track files is finished.



Loading tracks into a deck

The following describes the procedure for loading tracks into deck 1 (left side) as an example.

Turn the rotary selector to select a track in **[Collection]** and then press the **[LOAD]** button of deck 1 (left side).

The track is loaded into the deck.

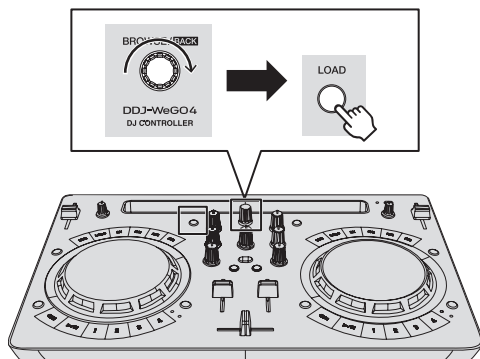

Playing a music file

The following describes the procedure for outputting the sound of deck 1 (left side) as an example.

1 Set the positions of the controls, etc., as shown below.

Names of controls, etc.	Position
1 EQ (HI, LOW) control	Center
2 FILTER control	Center
3 Channel fader	Moved forward
4 MASTER LEVEL control	Turned fully counterclockwise
5 Crossfader	Center

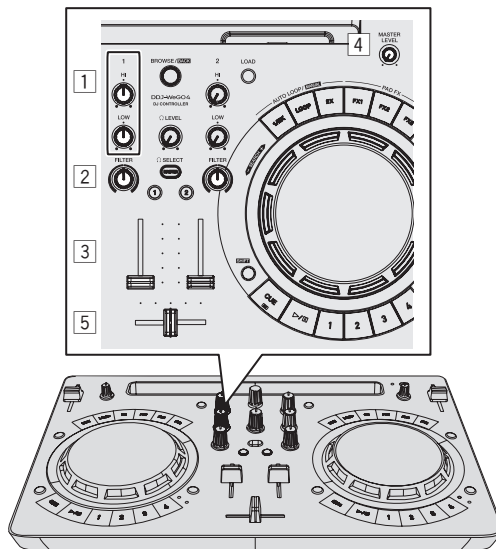

2 Press the **[PLAY/PAUSE/II]** button to play the track.

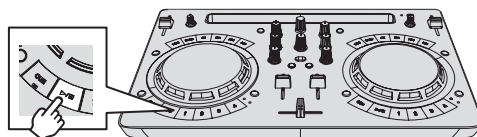

3 Move the channel fader away from you.

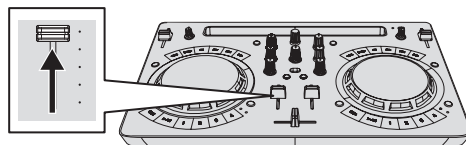

4 Turn the **[MASTER LEVEL]** control to adjust the audio level of the speakers.

Adjust the audio level output from the **[MASTER]** output terminals to an appropriate level.

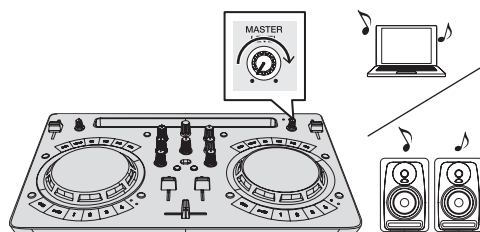

Sound is output from the speakers according to your audio environment. To adjust the volume of the sound output from a computer, use the volume adjustment function of the computer.

Monitoring sound with headphones

1 Set the positions of the controls, etc., as shown below.

Names of controls, etc.	Position
[HEADPHONES LEVEL] control	Turned fully counterclockwise

2 Press the [HEADPHONES SELECT 1] button.

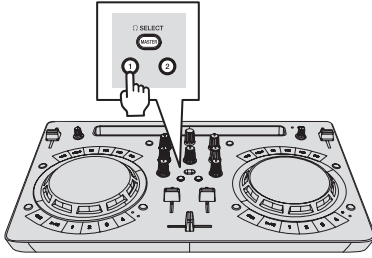

3 Turn the [HEADPHONES LEVEL] control.

Adjust the sound level output from the headphones to an appropriate level.

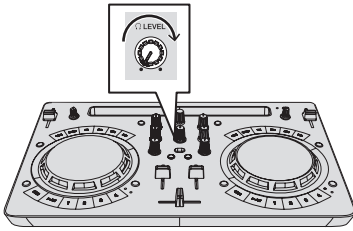

Inputting the sound of the microphone

The sound of the microphone connected to the [MIC] input terminal can be mixed.

1 Connect the microphone to the [MIC] input terminal.

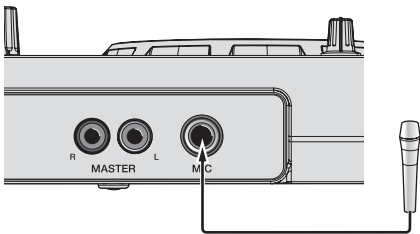

2 Click the [MIXER/MIC] button in rekordbox dj to display the mixer panel.



3 Click the [MIC ON] button in rekordbox dj.



4 Turn the [MIC LEVEL] control to adjust the audio level of the microphone.

The EQ can be adjusted and effects can be applied by connecting with rekordbox.

For the detailed operating procedures, see the Operating Instructions of rekordbox.

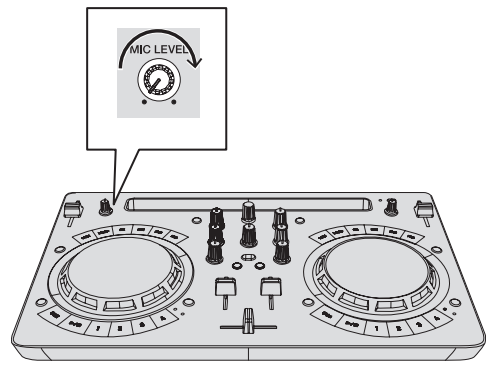

Quitting the system

1 Quit rekordbox.

2 Press the [STANDBY/ON] button until the unit enters standby.

rekordbox Advanced Operation

The descriptions from this point on are for functions that are specific for when this unit and rekordbox dj are used in combination and are not described in the rekordbox Operating Instructions.

Using hot cues

Playback can be started instantaneously from the position at which a hot cue is set. In addition to hot cues, loops can be set and called out instantaneously.

- Up to eight hot cue points can be set and saved per track, but only up to four can be operated with the buttons of this unit.

❖ Setting and calling out a hot cue

1 When the [HOT CUE] indicator is off, press the [HOT CUE/SAMPLER] mode switching button.

The unit switches to the hot cue mode and the indicator lights.

2 Press a performance button to set a hot cue point during playback or pause.

Hot cue points are assigned to the respective performance buttons as shown below.

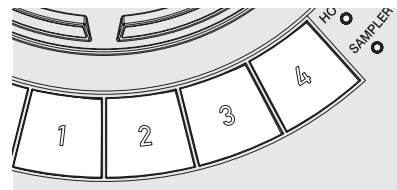

- [1] Hot cue A
- [2] Hot cue B
- [3] Hot cue C
- [4] Hot cue D

3 Press the performance button with the hot cue point set.

Playback starts from the hot cue point.

- A set hot cue point can be cleared by pressing a performance button while pressing the [SHIFT] button.

❖ Setting and calling out an auto beat loop

1 When the [HOT CUE] indicator is off, press the [HOT CUE/SAMPLER] mode switching button.

The unit switches to the hot cue mode and the indicator lights.

2 Press the loop half button or loop double button to set the length of the auto beat loop.

3 Press the loop button during playback.

The auto beat loop starts.

4 Press a performance button during auto beat loop playback to set the loop.

5 Press the performance button with the loop set.

Loop playback starts from the loop in point of the set loop.

- A set loop can be cleared by pressing a performance button while pressing the [SHIFT] button.

❖ Setting and calling out a manual loop

1 When the [HOT CUE] indicator is off, press the [HOT CUE/SAMPLER] mode switching button.

The unit switches to the hot cue mode and the indicator lights.

2 Press the loop half button while pressing the [SHIFT] button during playback and then press the loop button.

Loop playback starts.

3 Press a performance button during loop playback to set the loop.

4 Press the performance button with the loop set.

Loop playback starts from the loop in point of the set loop.

- A set loop can be cleared by pressing a performance button while pressing the [SHIFT] button.

Using the sampler function

The tracks loaded in the sampler slots of the sampler can be played with the performance buttons.

❖ Preparing to use the sampler

In the upper part of the rekordbox dj screen, click the [SAMPLER] button to display the sampler panel and click the [MIXER/MIC] button to display the mixer panel.



❖ Loading a track into a sampler slot

1 When the [SAMPLER] indicator is off, press the [HOT CUE/SAMPLER] mode switching button.

The unit switches to the sampler mode and the indicator lights.

2 Press the rotary selector to move the cursor to the track list.

3 Turn the rotary selector.

Select the track you wish to load in a sampler slot.

4 Drag and drop the track you wish to load to an empty slot of the sampler panel in rekordbox dj.

The selected track is loaded into the sample slot.

❖ Using the performance buttons to play the sampler

1 When the [SAMPLER] indicator is off, press the [HOT CUE/SAMPLER] mode switching button.

The unit switches to the sampler mode and the indicator lights.

2 Click the [SamplerBank] button in the sampler panel screen of rekordbox dj.

The sampler bank is switched. The sampler has four banks and each bank has sixteen slots.

3 Move the [SAMPLER VOL] fader in rekordbox dj upward.

4 Press a performance button.

The sound of the slot assigned to the button that was pressed is played.

- The first sampler bank is assigned to the respective button.

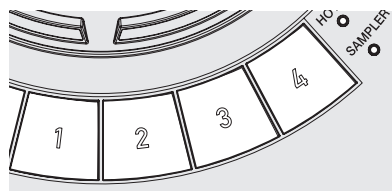

Deck 1 (left deck)

Deck 2 (right deck)

[1]	Slot 1	Slot 9
[2]	Slot 2	Slot 10
[3]	Slot 3	Slot 11
[4]	Slot 4	Slot 12

5 Press a performance button while pressing the [SHIFT] button.

Playback of the sound of the slot assigned to the button that was pressed is stopped.

Using the pad FX

A wide range of effect performances are possible with just the simple operation of pressing and releasing buttons.

1 Press and hold down the [FX] button or press and hold down the [FX] button while pressing the [SHIFT] button.

The effect turns on according to the effect assigned to the button and number of beats settings that was pressed.

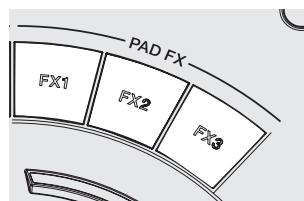

Without [SHIFT]

With [SHIFT]

[FX 1]	Effect A (Pad FX mode 1)	Effect C (Pad FX mode 2)
[FX 2]	Effect B (Pad FX mode 1)	Effect D (Pad FX mode 2)
[FX 3]	Release FX A (Pad FX mode 1)	Release FX B (Pad FX mode 2)

- The effects assigned to the [FX] buttons can be customized. (Customize the effects while this unit is in a connected state.)
- For the detailed operating procedures, see the Operating Instructions of rekordbox.

2 Release your finger from the [FX] button.

The effect turns off.

Using CFX

Effects can be obtained with just the simple operation of turning a control.

- 1 Click the [CFX] button in rekordbox dj to display the CFX panel.



- 2 Click the [FILTER] button in rekordbox dj.

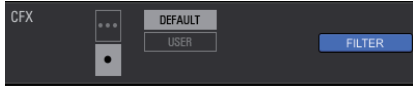

❖ Turning CFX on using the [FILTER] control

The effect is applied to the audio of the corresponding channel by turning the [FILTER] control.



❖ Customizing CFX

Effects can be customized from the CFX area of the rekordbox dj screen. For the detailed operating procedures, see the Operating Instructions of rekordbox.

Using recording functions

rekordbox dj has recording functions and can record mixed sound. For the detailed operating procedures, see the Operating Instructions of rekordbox.

- 1 Click the [REC] button in the global section of rekordbox dj.

The panel used for recording appears on the rekordbox dj screen.

- 2 Click  on the recording panel of rekordbox dj to enter the recording standby state.

- When sound is input, recording starts automatically.
- If you click  again, recording stops. If a state of no sound continues for at least 20 seconds, recording stops automatically.
- If the recording is completed, the file is automatically saved.
- The file save destination can be changed from the [Preferences] > [Controller] > [Recording] tab of rekordbox.

Using VirtualDJ LE 8

Before installing VirtualDJ LE 8

Installing the exclusive driver software for this unit on your computer

This driver software is an exclusive ASIO driver for outputting audio signals from the computer.

- There is no need to install the driver software when using Mac. Proceed to *Installation Procedure (Mac)* of *Installing VirtualDJ LE 8*.

System requirements

Supported operating systems

Windows® 10 / Windows® 8.1 / Windows® 7	32-bit version	✓
	64-bit version	✓

Downloading the latest driver software

Go to the [DDJ-WeGO4] page of the [DJ CONTROLLER] category from the [Software] page of the Pioneer DJ support site below and then download the exclusive driver software for this unit.
<http://www.pioneerdj.com/ja-jp/support/software/>

Before installing the driver software

- Press the [STANDBY/ON] button for at least 1 second, set this unit on standby status, and remove the USB cable that connects the unit and the computer.
- If any other programs are running on the computer, quit them.

Software end user license agreement

This Software End User License Agreement ("Agreement") is between you (both the individual installing the Program and any single legal entity for which the individual is acting) ("You" or "Your") and Pioneer DJ Corporation ("Pioneer DJ").

TAKING ANY STEP TO SET UP OR INSTALL THE PROGRAM MEANS THAT YOU ACCEPT ALL OF THE TERMS OF THIS LICENSE AGREEMENT. PERMISSION TO DOWNLOAD AND/OR USE THE PROGRAM IS EXPRESSLY CONDITIONED ON YOUR FOLLOWING THESE TERMS. WRITTEN OR ELECTRONIC APPROVAL IS NOT REQUIRED TO MAKE THIS AGREEMENT VALID AND ENFORCEABLE. IF YOU DO NOT AGREE TO ALL OF THE TERMS OF THIS AGREEMENT, YOU ARE NOT AUTHORIZED TO USE THE PROGRAM AND MUST STOP INSTALLING IT OR UNINSTALL IT, AS APPLICABLE.

1 DEFINITIONS

- 1 "Documentation" means written documentation, specifications and help content made generally available by Pioneer DJ to aid in installing and using the Program.
- 2 "Program" means all or any part of Pioneer DJ's software licensed to You by Pioneer DJ under this Agreement.

2 PROGRAM LICENSE

- 1 Limited License. Subject to this Agreement's restrictions, Pioneer DJ grants to You a limited, non-exclusive, non-transferable, license (without the right to sublicense):
 - a To install a single copy of the Program in Your computer or mobile device, to use the Program only for Your personal purpose complying with this Agreement and the Documentation ("Authorized Use");
 - b To use the Documentation in support of Your Authorized Use; and
 - c To make one copy of the Program solely for backup purposes, provided that all titles and trademark, copyright and restricted rights notices are reproduced on the copy.

- 2 Restrictions. You will not copy or use the Program or Documentation except as expressly permitted by this Agreement. You will not transfer, sublicense, rent, lease or lend the Program, or use it for third-party training, commercial time-sharing or service bureau use. You will not Yourself or through any third party modify, reverse engineer, disassemble or decompile the Program, except to the extent expressly permitted by applicable law, and then only after You have notified Pioneer DJ in writing of Your intended activities.
- 3 Ownership. Pioneer DJ or its licensor retains all right, title and interest in and to all patent, copyright, trademark, trade secret and other intellectual property rights in the Program and Documentation, and any derivative works thereof. You do not acquire any other rights, express or implied, beyond the limited license set forth in this Agreement.
- 4 No Support. Pioneer DJ has no obligation to provide support, maintenance, upgrades, modifications or new releases for the Program or Documentation under this Agreement.

3 WARRANTY DISCLAIMER

THE PROGRAM AND DOCUMENTATION ARE PROVIDED "AS IS" WITHOUT ANY REPRESENTATIONS OR WARRANTIES, AND YOU AGREE TO USE THEM AT YOUR SOLE RISK. TO THE FULLEST EXTENT PERMISSIBLE BY LAW, PIONEER DJ EXPRESSLY DISCLAIMS ALL WARRANTIES OF ANY KIND WITH RESPECT TO THE PROGRAM AND DOCUMENTATION, WHETHER EXPRESS, IMPLIED, STATUTORY, OR ARISING OUT OF COURSE OF PERFORMANCE, COURSE OF DEALING OR USAGE OF TRADE, INCLUDING ANY WARRANTIES OF MERCHANTABILITY, FITNESS FOR A PARTICULAR PURPOSE, SATISFACTORY QUALITY, ACCURACY, TITLE OR NON-INFRINGEMENT.

4 EXPORT CONTROL AND COMPLIANCE WITH LAWS AND REGULATIONS

You may not use or otherwise export or re-export the Program except as authorized by United States law and the laws of the jurisdiction in which the Program was obtained. In particular, but without limitation, the Program may not be exported or re-exported (a) into any U.S.-embargoed countries or (b) to anyone on the U.S. Treasury Department's Specially Designated Nationals List or the U.S. Department of Commerce Denied Persons List or Entity List. By using the Program, you represent and warrant that you are not located in any such country or on any such list. You also agree that you will not use the Program for any purposes prohibited by United States law, including, without limitation, the development, design, manufacture, or production of nuclear, missile, or chemical or biological weapons.

5 U.S. GOVERNMENT RESTRICTED RIGHTS

The Program and Documentations are "commercial computer software" and "commercial computer software documentation" as those terms are defined in 48 C.F.R. §252.227-7014 (a) (1) (2007) and 252.227-7014 (a) (5) (2007). The U.S. Government's rights with respect to the Program and Documentations are limited by this license pursuant to 48 C.F.R. §12.212 (Computer software) (1995) and 48 C.F.R. §12.211 (Technical data) (1995) and/or 48 C.F.R. §227.7202-3, as applicable. As such, the Program and Documentations are being licensed to the U.S. Government end users: (a) only as "commercial items" as that term is defined in 48 C.F.R. §2.101 generally and as incorporated in DFAR 212.102; and (b) with only those limited rights as are granted to the public pursuant to this license. Under no circumstance will the U.S. Government or its end users be granted any greater rights than we grant to other users, as provided for in this license. Manufacturer is Pioneer DJ Corporation, 1-1 Shin-Ogura, Saiwai-ku, Kawasaki-shi, Kanagawa, 212-0031 Japan

6 DAMAGES AND REMEDIES FOR BREACH

You agree that any breach of this Agreement's restrictions would cause Pioneer DJ irreparable harm for which money damages alone would be inadequate. In addition to damages and any other remedies to which Pioneer DJ may be entitled, You agree that Pioneer DJ may seek injunctive relief to prevent the actual, threatened or continued breach of this Agreement.

7 TERMINATION

Pioneer DJ may terminate this Agreement at any time upon Your breach of any provision. If this Agreement is terminated, You will stop using the Program, permanently delete it from your computer or mobile device where it resides, and destroy all copies of the Program and Documentation in Your possession, confirming to Pioneer DJ in writing that You have done so. Sections 2.2, 2.3, 2.4, 3, 4, 5, 6, 7 and 8 will continue in effect after this Agreement's termination.

8 GENERAL TERMS

- 1** Limitation of Liability. In no event will Pioneer DJ or its subsidiaries be liable in connection with this Agreement or its subject matter, under any theory of liability, for any indirect, incidental, special, consequential or punitive damages, or damages for lost profits, revenue, business, savings, data, use, or cost of substitute procurement, even if advised of the possibility of such damages or if such damages are foreseeable. In no event will Pioneer DJ's liability for all damages exceed the amounts actually paid by You to Pioneer DJ or its subsidiaries for the Program. The parties acknowledge that the liability limits and risk allocation in this Agreement are reflected in the Program price and are essential elements of the bargain between the parties, without which Pioneer DJ would not have provided the Program or entered into this Agreement.
- 2** The limitations or exclusions of warranties and liability contained in this Agreement do not affect or prejudice Your statutory rights as consumer and shall apply to You only to the extent such limitations or exclusions are permitted under the laws of the jurisdiction where You are located.
- 3** Severability and Waiver. If any provision of this Agreement is held to be illegal, invalid or otherwise unenforceable, that provision will be enforced to the extent possible or, if incapable of enforcement, deemed to be severed and deleted from this Agreement, and the remainder will continue in full force and effect. The waiver by either party of any default or breach of this Agreement will not waive any other or subsequent default or breach.
- 4** No Assignment. You may not assign, sell, transfer, delegate or otherwise dispose of this Agreement or any rights or obligations under it, whether voluntarily or involuntarily, by operation of law or otherwise, without Pioneer DJ's prior written consent. Any purported assignment, transfer or delegation by You will be null and void. Subject to the foregoing, this Agreement will be binding upon and will inure to the benefit of the parties and their respective successors and assigns.
- 5** Entire Agreement. This Agreement constitutes the entire agreement between the parties and supersedes all prior or contemporaneous agreements or representations, whether written or oral, concerning its subject matter. This Agreement may not be modified or amended without Pioneer DJ's prior and express written consent, and no other act, document, usage or custom will be deemed to amend or modify this Agreement.
- 6** You agree that this Agreement shall be governed and construed by and under the laws of Japan.

Installation Procedure

Do not connect this unit and the computer until installation is completed.

- Log on as the user which was set as the computer's administrator before installing.
- If any other programs are running on the computer, quit them.

1 Download the driver installer from the Pioneer DJ support site.

2 When downloading is complete, double-click the [Install Driver Software (DDJ_WeGO4_Driver_x.xxx)] icon.

3 Proceed with installation according to the instructions on the screen.

If **[Windows Security]** appears on the screen while the installation is in progress, click **[Install this driver software anyway]** and continue with the installation.

When the installation program is completed, a completion message appears.

After installing the driver software, install the VirtualDJ LE 8 software.

Installing VirtualDJ LE 8

About VirtualDJ LE 8

VirtualDJ LE 8 is a DJ software application by Atomix productions. DJ performances are possible by connecting the computer on which this software is installed to this unit.

If Virtual DJ is already installed on your computer, the software will not operate correctly. Uninstall all versions of Virtual DJ installed on your computer before installing VirtualDJ LE 8 for this unit.

For instructions on uninstalling VIRTUAL DJ, see the Pioneer DJ support site below.

<http://pioneerdj.com/support/>

Minimum operating environment

Supported operating systems	CPU and required memory
Mac: macOS Sierra 10.12, OS X 10.11/10.10/10.9	Intel® processor 1 024 MB or more of RAM
Windows: Windows® 10, Windows® 8.1, Windows® 7	Intel® Pentium® 4 or AMD Athlon™ XP 512 MB or more of RAM

Others	
Hard disk	Free space of 20 MB or greater (Windows) Free space of 30 MB or greater (Mac)
USB port	A USB 2.0 port is required to connect the computer with this unit.
Internet connection	An Internet connection is required to register the account and download VirtualDJ LE 8.

The conditions below must be satisfied in order to conduct video mixing.

- Mac
 - ATI™ or NVIDIA® video chipset with 256 MB of dedicated DDR3 RAM
 - Video card must support dual-screen output.
- Windows
 - ATI™ or NVIDIA® video card with 256 MB of dedicated DDR3 RAM
 - Video card must support dual-screen output.
- For information on the latest system requirements, compatibility, and supported operating systems, see **[DDJ-WeGO4]** of the **[DJ CONTROLLER]** category from the **[SOFTWARE INFORMATION]** page of the Pioneer DJ support site below. <http://www.pioneerdj.com/en/support/software-information/>
- Use a computer that meets the system requirements described above. The system requirements for DJ software may differ.
- Full functionality is not guaranteed on all computers, even those meeting the operating environment requirements described above.
- Even with the required memory indicated for the operating environment above, lack of memory due to resident programs, the number of services, etc., could prevent the software from offering optimal functionality and performance. In such cases, free up sufficient memory.
- Depending on the power-saving settings and other conditions of the computer, the CPU and hard disk processing capacity may be insufficient. In particular, when using a notebook computer, connect an AC power supply and always use the computer with the settings configured for high performance.
- Problems may occur with operation depending on the other software that you use.
- Use of the Internet requires a separate contract with a provider offering Internet services and payment of provider fees.

Installation procedure (Windows)

1 Go to the [DDJ-WeGO4] page of the [DJ CONTROLLER] category from the [SOFTWARE INFORMATION] page of the Pioneer DJ support site below.

<http://www.pioneerdj.com/en/support/software-information/>

2 Click [VirtualDJ] of the [OVERVIEW] category and then click the link to the VirtualDJ LE 8 download page.

The VirtualDJ LE 8 download page appears.

3 Enter the serial key shown on the Virtual DJ LE 8 license key card included with this product in the displayed page and then click [OK].

4 The download link of the installer is displayed; click the installer for Windows to perform download.

5 Double-click the downloaded file.

The installer starts.

6 Follow the instructions on the displayed screens and install the software.

① Click [Next].

— To cancel the installation, click [Cancel].



② Read the terms of the license agreement carefully, and if you agree, select [I accept the terms in the License Agreement], then click [Next].

— If you do not agree to the contents of the license agreement, click [Cancel] to cancel installation.

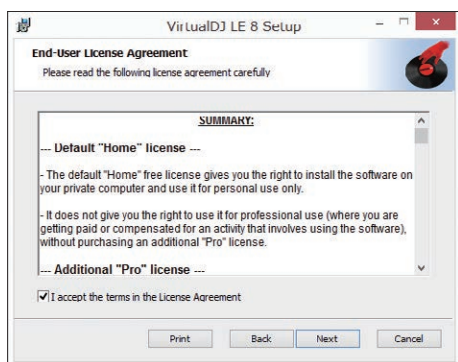

③ Select the type of installation for VirtualDJ LE 8, then click. Normally select [Typical]. When [Typical] is selected, plug-ins and other components are installed simultaneously.

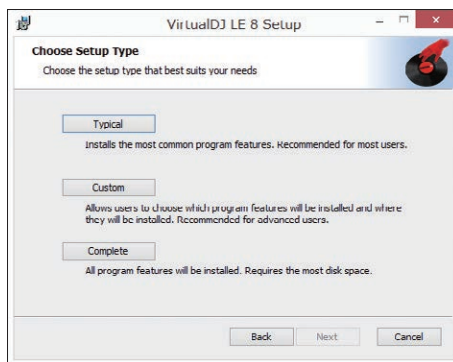

④ Click [Install] to start the installation.

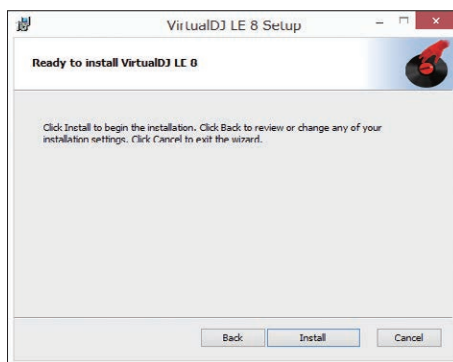

⑤ Click [Finish].

The installation is now complete.

Installation Procedure (Mac)

1 Go to the [DDJ-WeGO4] page of the [DJ CONTROLLER] category from the [SOFTWARE INFORMATION] page of the Pioneer DJ support site below.

<http://www.pioneerdj.com/en/support/software-information/>

2 Click [VirtualDJ] of the [OVERVIEW] category and then click the link to the VirtualDJ LE 8 download page.

The VirtualDJ LE 8 download page appears.

3 Enter the serial key shown on the Virtual DJ LE 8 license key card included with this product in the displayed page and then click [OK].

4 The download link of the installer is displayed; click the installer for Mac to perform download.

5 Double-click the downloaded file.

The installer starts.

6 Follow the instructions on the displayed screens and install the software.

The installation is now complete.

About the driver software and setting utility software

This unit functions as an audio device conforming to the ASIO standards.

Using the settings utility software

This function can only be used by those using a Windows operating system.

❖ Launching the settings utility software

For Windows 10/8.1

Click [Pioneer] > [DDJ_WeGO4 ASIO Settings Utility] from [Apps view].

For Windows 7

Click [All Programs] > [Pioneer] > [DDJ_WeGO4] > [DDJ_WeGO4 ASIO Settings Utility] from the [Start] menu of Windows.

❖ Adjusting the buffer size

In the same way as the buffer size setting in VirtualDJ LE 8, decreasing the value of the [Kernel Buffers] setting lowers the transfer delay (latency) of the audio data, while increasing the value reduces the tendency for dropouts in the audio data (breaks in the sound).

- If the [Buffer Size] or [Kernel Buffers] number is made large, drops in the data (breaks in the sound), etc., occur less easily, but the time lag due to transmission delays in the audio data (latency) increases.

❖ If breaks in the sound occur with the default setting

Launch [DDJ_WeGO4 ASIO Settings Utility] and change [Kernel Buffers] to [4].

❖ If no breaks in the sound occur with the default setting

Launch [DDJ_WeGO4 ASIO Settings Utility], change [Kernel Buffers] to [2], and check that no breaks in the sound occur.

- If breaks in sound occur, change [Kernel Buffers] of [DDJ_WeGO4 ASIO Settings Utility] to [3].

Checking the version of the driver software

For Windows 10/8.1

From [Apps view], click [Pioneer] > [DDJ_WeGO4 Version Display Utility].

For Windows 7

Click [All Programs] > [Pioneer] > [DDJ_WeGO4] > [DDJ_WeGO4 Version Display Utility] from the Windows [Start] menu.

- You can check the firmware version of this unit on the screen.
- The firmware version is not displayed when this unit is not connected to the computer or when this unit and computer are not properly communicating.

Connections

1 Connect speakers with a built-in amplifier, a power amplifier, etc. to the [MASTER] output terminals of this unit.

- An audio cable (RCA) is not included with this product. Please provide it yourself separately.

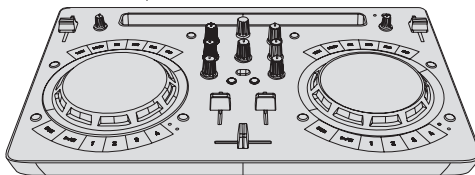
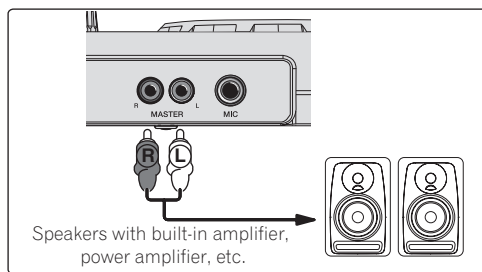

- For details on connecting the input/output terminals, see page 7.
- Set the volume of the device connected to the [MASTER] terminals (speakers with built-in amplifier, power amplifier, etc.) to an appropriate level. Note that the output sound may be loud if the volume is set too high.

2 Connect headphones to an [PHONES] output terminal of this unit.

- Connect stereo headphones with an impedance of 32 Ω or higher. Headphones with an impedance less than 32 Ω and mono headphones are not supported.
- Do not connect headphones simultaneously to the stereo phone jack and the stereo mini-phone jack.

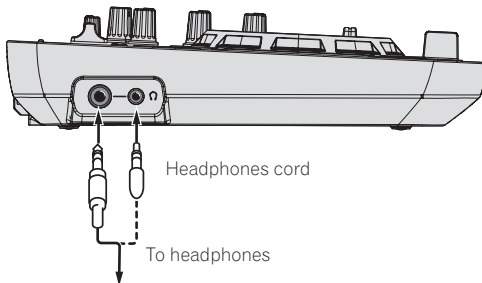

3 Connect this unit to your computer via a USB cable.

- Be sure to connect directly using the USB cable included with this product. A USB hub cannot be used.

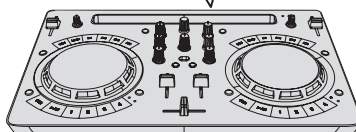
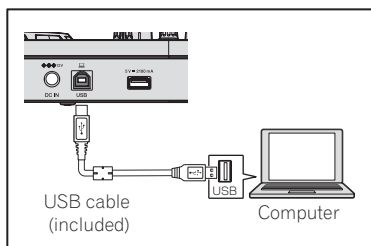

4 Connect the included DC plug of the AC adapter to this unit and then connect the power cord.

- Connect the power cord after all the connections between devices have been completed.
- Connection is not necessary when operating with bus power supplied from a USB port of the computer.
- Be sure to use the power cord and AC adapter included with this product.

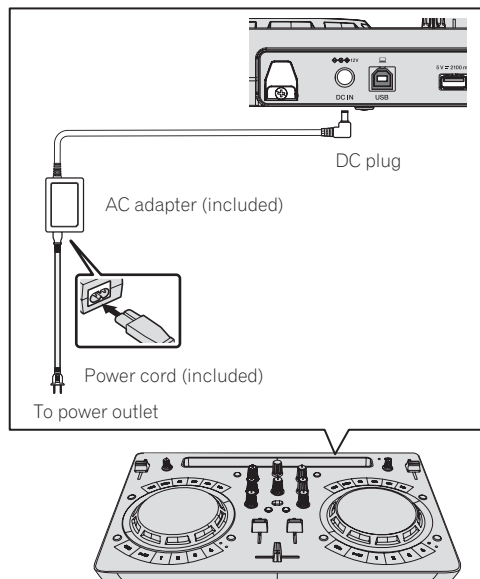

Start up the system

Cautions for people using Windows

When you connect this unit to a computer for the first time or connect it to a different USB terminal, the **[Installing device driver software]** alert may appear. If it appears, wait until the installation finishes.

- 1 Turn on the computer's power.
- 2 Press the **[STANDBY/ON]** button of this unit to turn on the power of the unit.

After the startup illumination ends, the unit is ready for use.

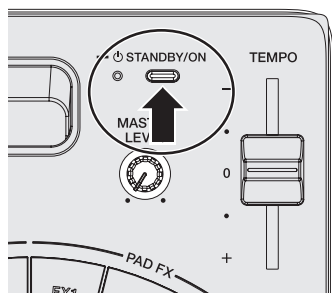

- 3 Turn on the power of the device (speakers with built-in amplifier, power amplifier, etc.) connected to the output terminals.

4 Launch VirtualDJ LE 8.

- For Windows 10/8.1
Click the **[VirtualDJ 8]** icon from **[Apps view]**.
- For Windows 7
Click the **[All Programs]** > **[VirtualDJ]** > **[VirtualDJ 8]** icon from the **[Start]** menu of Windows.
- For macOS Sierra 10.12 and OS X 10.11/10.10/10.9
In Finder, open the **[Application]** folder, then double-click the **[VirtualDJ 8]** icon.

5 Log in.

- You can use VirtualDJ LE 8 without login.
If you do not want to log in, close the login window and proceed to the next step.
- When VirtualDJ LE 8 is started, the login window appears.
 - Those who have a Virtual DJ account
Enter necessary information in the login window to log in.
 - Those who do not have a Virtual DJ account
From the login window, create a new account and log in.

6 Enter the serial key.

Enter the serial key shown on the VirtualDJ LE 8 license key card included with this product as instructed in the displayed screen and then click **[OK]**.

- When serial key is entered without login, the login window is displayed again. However, you can use VirtualDJ LE 8 without login. If you do not want to log in, close the login window.

Operation

Loading tracks into a deck

The following describes the procedure for loading tracks into deck 1 (left side) as an example.

- 1 Turn the rotary selector while pressing the **[SHIFT]** button to select a folder containing tracks.
 - Press the rotary selector while pressing the **[SHIFT]** button to open or close the folder.
- 2 Turn the rotary selector to select a track in the folder and then press the **[LOAD]** button of deck 1 (left side).
The track is loaded into the deck.

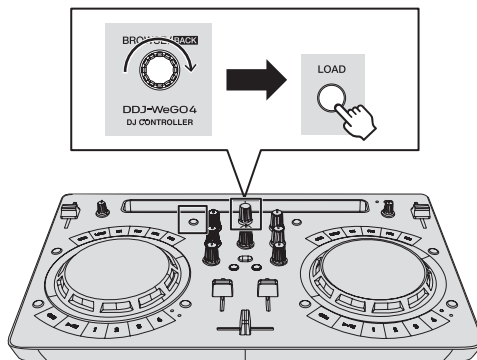

Playing a music file

The following describes the procedure for outputting the sound of deck 1 (left side) as an example.

- 1 Set the positions of the controls, etc., as shown below.

Names of controls, etc.	Position
EQ (HI, LOW) controls	Center
FILTER control	Center
Channel fader	Moved forward
MASTER LEVEL control	Turned fully counterclockwise
Crossfader	Center

- Press the [PLAY/PAUSE▶/II] button to play the track.

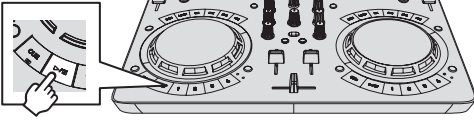

- Move the channel fader away from you.

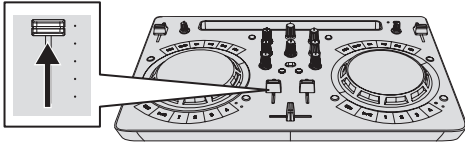

- Turn the [MASTER LEVEL] control to adjust the audio level of the speakers.

Adjust the audio level output from the [MASTER] output terminals to an appropriate level.

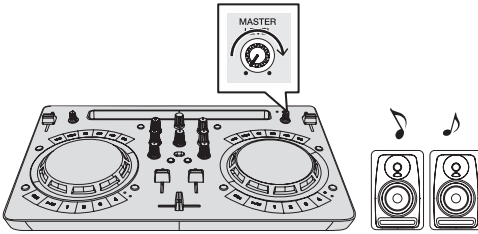

Sound is output from the speakers.

Monitoring sound with headphones

- Set the positions of the controls, etc., as shown below.

Names of controls, etc.	Position
[HEADPHONES LEVEL] control	Turned fully counterclockwise

- Press the [HEADPHONES SELECT 1] button.

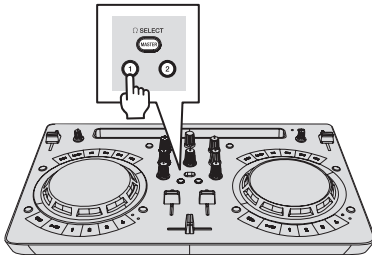

- Turn the [HEADPHONES LEVEL] control.

Adjust the sound level output from the headphones to an appropriate level.

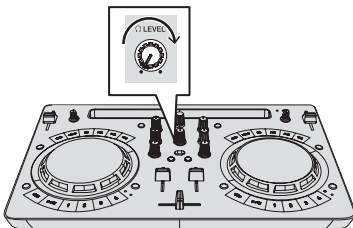

Inputting the sound of the microphone

The sound of the microphone connected to the [MIC] input terminal can be mixed.

- Connect the microphone to the [MIC] input terminal.

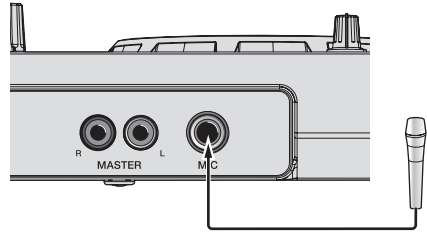

- Turn the [MIC LEVEL] control to adjust the audio level of the microphone.

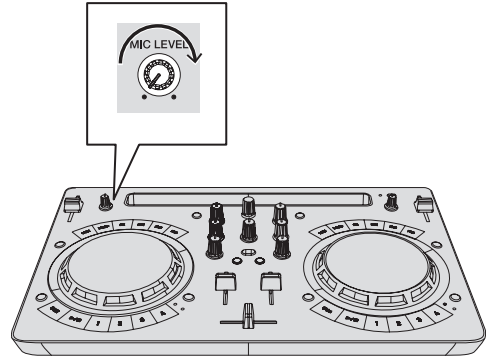

Quitting the system

- Quit VirtualDJ 8.
- Press the [STANDBY/ON] button until the unit enters standby.

Note

The software manual of VirtualDJ LE 8 can be downloaded from the Atomix productions website. For details, see [DDJ-WeGO4] of the [DJ CONTROLLER] category from the [SOFTWARE INFORMATION] page of the Pioneer DJ site below. <http://www.pioneerdj.com/en/support/software-information/>

Changing the settings

Launching utilities mode

If the utilities mode is launched while the DJ application is running, the set status may not be displayed properly.

1 If the USB cable is connected, disconnect it from the computer.

2 If the cable included with the iPhone / iPad is connected, disconnect it from the iPhone / iPad.

3 Sets the unit on standby status.

LED next to [STANDBY/ON] button on the upper right of the unit is in red lighted status.

4 While holding down the [LOAD] button on the left-side deck and the [LOAD] button on the right-side deck, press the [STANDBY/ON] button.

The unit starts up in utility mode. (The [SYNC] buttons on both decks light up.)

5 For items for which you would like to change the settings, change the settings.

See the *Utilities modes* below for the settings that can be changed, and for the setting change methods.

6 Check that the [SYNC] button is in lighted state, and then press the [STANDBY/ON] button to restart the unit.

Performing restart may be necessary to reflect the changed setting.

Caution

When the [SYNC] button is flashing, this unit is writing the setting. If the [STANDBY/ON] button is pressed to perform restart while the [SYNC] button is flashing, the set values are not reflected in the unit.

Utilities modes

The following settings can be changed:

- Demo mode setting
- Charging mode setting
- Pulse mode (illumination) setting

❖ Demo mode setting

After restarting the unit, if no operation is performed for a certain set period, it starts in demo mode. The amount of time until start in this demo mode can be changed.

Press the [HOT CUE/SAMPLER] mode switching button on the left deck.

Left deck [1] button lighted: 10 min [Default value]

Left deck [2] button lighted: 5 min

Left deck [3] button lighted: 1 min

Left deck [CUE] button lighted: OFF

❖ Charging mode setting

Set the charging method for when an iPhone / iPad is connected to the unit.

Press the [HOT CUE/SAMPLER] mode switching button on the right deck.

Right deck [1] button lit: Charging is possible when the power is on only, and auto standby is enabled. [Default setting]

Right deck [2] button lit: Charging is possible when powered on only, and auto standby is disabled.

Right deck [3] button lit: Charging is always possible.

- To charge an iPhone / iPad, power needs to be supplied from the AC adapter.
- When the auto standby setting is on and if four hours have passed while the following conditions are all met, the unit automatically enters standby status.
 - 1 No buttons or controls, etc. on this unit except for the [MIC LEVEL] control are operated.
 - 2 Audio signals are not input to this unit (excluding microphone audio input).
- When the unit is set to always allow charging, auto standby is disabled.

❖ Pulse mode (illumination) setting

This unit is equipped with two types of pulse mode (illumination lighted/flashing mode).

Press the [HEADPHONES SELECT MASTER] button.

[HEADPHONES SELECT 1] button lit: Normal (standard LED lighting/flashing pattern) [Default value]

[HEADPHONES SELECT 2] button lighted: Moderate (LED brightness suppress lighted/flashing pattern)

Changing the settings with rekordbox

The settings required for the DJ player can be changed with rekordbox. Change the setting items in [Controller] of [Preferences].

The following settings can be changed only when rekordbox and this unit are connected.

- The [Low Cut Filter] setting of the [MIC] input, the [Talkover Mode] setting of the [MIC] input, and the [Talkover Level] setting of the [MIC] input are reflected only when there is the combination of the unit and rekordbox.

[Low Cut Filter] setting of [MIC] input

Set whether or not to apply a filter to attenuate sounds lower than the human voice to microphone sound.

This low cut filter reduces input of background noise generated from speakers, etc. into the microphone.

- On: Enables the low cut filter of microphone sound.
- Off: Disables the low cut filter of microphone sound.

[Talkover Mode] setting of [MIC] input

Switches the talkover mode.

- [Advanced] (Advanced talk over mode): Sound other than that of the microphone is output with only the midrange attenuated according to the talk over level setting value.

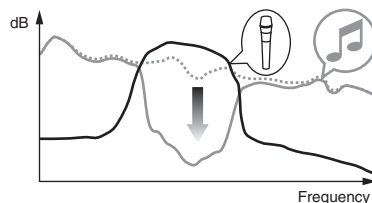

- [Normal] (Normal talk over mode): Sound other than that of the microphone is output attenuated according to the talk over level setting value.

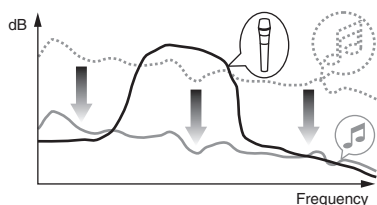

[Talkover Level] setting of [MIC] input

Sets the talk over function's sound attenuation level.
Setting values: -6 dB / -12 dB / -18 dB / -24 dB

About the driver software and setting utility software

This unit functions as an audio device conforming to the ASIO standards.

Using the settings utility software

This function can only be used by those using a Windows operating system.

❖ Launching the settings utility software

For Windows 10/8.1

Click **[Pioneer]** > **[DDJ_WeGO4 ASIO Settings Utility]** from **[Apps view]**.

For Windows 7

Click **[All Programs]** > **[Pioneer]** > **[DDJ_WeGO4]** > **[DDJ_WeGO4 ASIO Settings Utility]** from the **[Start]** menu of Windows.

❖ Adjusting the buffer size

In the same way as the setting of **[Buffer Size]**, decreasing the value of the **[Kernel Buffers]** setting lowers the transfer delay (latency) of the audio data, while increasing the value reduces the tendency for dropouts (breaks in the sound) to occur in the audio data (the default setting of **[Buffer Size]** is 512 samples/10 ms and the default setting of **[Kernel Buffers]** is **[3]**).

- If the **[Buffer Size]** or **[Kernel Buffers]** number is made large, drops in the data (breaks in the sound), etc., occur less easily, but the time lag due to transmission delays in the audio data (latency) increases.

❖ If breaks in the sound occur with the default setting

1 Launch **[DDJ_WeGO4 ASIO Settings Utility]** and change **[Kernel Buffers]** to **[4]**.

2 Set to the minimum **[Buffer Size]**, with which breaks in the sound do not occur.

❖ If no breaks in the sound occur with the default setting

1 Launch **[DDJ_WeGO4 ASIO Settings Utility]** to set to the minimum **[Buffer Size]**, with which breaks in the sound do not occur.

2 Change **[Kernel Buffers]** to **[2]**, and check that no breaks occur in the sound.

3 If no breaks occur in the sound, set to the minimum **[Buffer Size]**. If breaks do occur in the sound, change **[Kernel Buffers]** to **[3]**.

Checking the version of the driver software

For Windows 10/8.1

From **[Apps view]**, click **[Pioneer]** > **[DDJ_WeGO4 Version Display Utility]**.

For Windows 7

Click **[All Programs]** > **[Pioneer]** > **[DDJ_WeGO4]** > **[DDJ_WeGO4 Version Display Utility]** from the Windows **[Start]** menu.

- You can check the firmware version of this unit on the screen.
- The firmware version is not displayed when this unit is not connected to the computer or when this unit and computer are not properly communicating.

Checking the latest information on the driver software

For the latest information on the driver software for exclusive use with this unit, see **[DDJ-WeGO4]** from the **[DJ CONTROLLER]** category of **[Software]** of the Pioneer DJ site below.

<http://www.pioneerdj.com/en/support/software/>

Additional information

Troubleshooting

- If you think that there is something wrong with this unit, check the items below and access the Pioneer DJ site and check [FAQ] for the [DDJ-WeGO4].
<http://pioneerdj.com/>
 Sometimes the problem may lie in another component. Inspect the other components and electrical appliances being used. If the problem cannot be rectified, ask your nearest service center or your dealer to carry out repair work.
- The player may not operate properly due to static electricity or other external influences. In such cases, normal operation may become possible if you turn the power off and then back on.

Problem	Check	Remedy
The power of the unit does not turn on.	Is the included AC adapter properly connected?	When using an iPhone / iPad and this unit in combination, be sure to properly connect the included AC adapter.
	Is the included USB cable properly connected?	When using a computer and this unit in combination, be sure to properly connect the included USB cable.
	Is the supply of power from the connected computer's USB port insufficient?	When using a computer and this unit in combination using the USB bus power of the computer, connect to a USB port capable of a sufficient supply of power. If devices not being used for the DJ performance are connected to other USB ports, also disconnect them to provide sufficient power. Run the connected computer with the power supplied from an AC adapter rather than running it on the battery.
This unit is not recognized on the computer.	Is the [STANDBY/ON] indicator green?	Press the [STANDBY/ON] button to turn the power on.
	Is the included USB cable properly connected?	When using a computer and this unit in combination, be sure to properly connect the included USB cable.
	Are you using a USB hub?	USB hubs cannot be used. Connect the computer and this unit directly using the included USB cable.
	Is an iPhone / iPad connected?	Disconnect the iPhone / iPad.
This unit is not recognized by an iPhone / iPad. (The iPhone / iPad does not respond even if this unit is operated.)	Is the included AC adapter properly connected?	When using an iPhone / iPad and this unit in combination, be sure to properly connect the included AC adapter.
	Is the cable included with the iPhone / iPad properly connected?	Properly connect the cable included with the iPhone / iPad.
	Is a computer connected?	Disconnect the computer.
The unit and DJ software controls and sliders positions differ.	—	When the unit controls and sliders are moved, the DJ software controls and sliders are synchronized.
Distorted sound.	Is the [MASTER LEVEL] control set to the proper position?	Adjust the [MASTER LEVEL] control according to the devices to be connected.
	Is the [HEADPHONES LEVEL] control set to the proper position?	Adjust the [HEADPHONES LEVEL] control according to the device to be connected.
	Is the level of the audio input to the [MIC] input terminal set to an appropriate level?	Set the level of the audio input to the [MIC] input terminal to an appropriate level for the connected device.
Sound being played is interrupted when using DJ software.	Is the computer connected to this unit connected to an AC power supply?	When using a notebook computer on battery power, the power management system may set the battery energy saving mode, decreasing the CPU's clock frequency. If this happens, noise may be generated and operation may become slower. Connect the computer to which this unit is to be connected to an AC power supply.
	Is the driver software's latency value suitable? (Windows)	Set the driver software's latency to a suitable value.
	Is the buffer size (latency) value of the DJ software appropriate?	Set the buffer size (latency) value of the DJ software appropriately.
No sound or small sound.	Are the channel faders, crossfader and [MASTER LEVEL] control set to the proper positions?	Set the channel faders, crossfader and [MASTER LEVEL] control to the proper positions.
	Is the connected, power amplifier, powered speakers, etc., properly set?	Properly set the external input selection, volume, etc., on the power amplifier, powered speakers, etc.
	Is the included USB cable properly connected? (When combined with computer)	Connect the included USB cable properly.
	Is the cable included with the iPhone / iPad properly connected? (When combined with iPhone / iPad)	Properly connect the cable included with the iPhone / iPad.
	Are the terminals and plugs dirty?	Clean the terminals and plugs before making connections.
	Is the driver software properly set? (Windows only)	Set the driver software properly. (The driver software is not required for Mac.)
	Are the connection cables properly connected?	Connect the connection cables properly.
	Is the volume of the Android device properly set? (When combined with Android device)	Set the volume of the Android device properly.
Sound is interrupted when the ASIO driver is set.	Has the ASIO driver been set with the DJ software started up?	Set the ASIO driver before starting up the DJ software.

Problem	Check	Remedy
Sound is not output from the [MIC] input terminal.	Is the [MIC ON] button in the microphone panel of rekordbox off?	Turn the [MIC ON] button in the microphone panel of rekordbox on.
There is no response when the jog dial is touched.	Is the jog dial dirty?	An electrostatic system is used as the detection method in the jog dial of this unit. Therefore, if the jog dial is dirty or the user has hand cream on their hands, detection may not respond. When cleaning the jog dial, dry wipe with a soft cloth. If it is very dirty, prepare a 5:1 or 6:1 solution of water and neutral detergent, immerse a soft cloth in the solution and wring out well, then clean the jog dial and wipe with a dry cloth after that.
	Does the jog dial respond when touched while touching some other metal part of the unit?	If there is a response when touching the jog dial while touching some other metal part of the unit, there is a possibility that the unit is being affected by a device connected to the unit. Review the connection environment (installation location, ground connection status, etc.) of the devices (computer, amplifier, etc.) connected to this unit.
iPhone / iPad cannot be charged.	Are you using the unit on USB bus power?	An iPhone / iPad can be charged only when the unit is connected to an AC adapter. Connect the unit and the AC adapter, and then connect the iPhone / iPad.
	Is the charging mode of this unit set to "Charging is possible when the power is on only" and is the [STANDBY/ON] indicator red?	If the charging mode of this unit is set to "Charging is possible when the power is on only," the iPhone / iPad can be charged when the [STANDBY/ON] indicator is green. If the charging mode is set to "Charging is always possible," the iPhone / iPad can be charged when the [STANDBY/ON] indicator is green and when it is red.
	Is a computer connected?	Disconnect the computer.
	Is the power of the iPhone / iPad off?	An iPhone / iPad cannot be charged when the power of the iPhone / iPad is off. Turn on the power of the iPhone / iPad, and then connect the iPhone / iPad to the unit.
	Does the iPhone / iPad have enough battery power?	An iPhone / iPad cannot be charged when the power cannot be turned on because the iPhone / iPad has no battery power remaining. Use the charger included with the iPhone / iPad to recharge the iPhone / iPad, turn on the power, and then connect to the unit.
	Is the [STANDBY/ON] indicator flashing?	Disconnect the connected iPhone / iPad, and check the connection cable.
[STANDBY/ON] indicator is flashing.	—	If operation is abnormal, or it won't start up, disconnect the AC adapter or USB cable, wait for a little while, and then restart again. If the symptoms still appear, put in a request for repairs.
Noise occurs in the sound.	—	Sound problems (communication noise) may occur on the unit when an iPhone / iPad is used for a call or sending and receiving data. If such symptoms occur, change the location or orientation of the iPhone / iPad. If the problem is still not resolved, turn off the mobile data communications of the iPhone / iPad and use a Wi-Fi connection or turn on Airplane Mode.

Using as a controller for other DJ software

This unit also outputs the operating data for the buttons and controls in MIDI format. If you connect a computer with a built-in MIDI-compatible DJ software via a USB cable, you can operate the DJ software on this unit. The sound of music files being played on the computer can also be output from the DDJ-WEGO4.

Set the DJ software's audio and MIDI related settings.

For details, see your DJ software's operating instructions.

About MIDI messages

For details on this unit's MIDI messages, see "List of MIDI Messages".

- "List of MIDI Messages" can be obtained from [MIDI-compatible software] of [SOFTWARE INFORMATION] of [DDJ-WeGO4] on the Pioneer DJ support site below.
<http://pioneerdj.com/support/>

About trademarks and registered trademarks

- "Pioneer DJ" is a trademark of PIONEER CORPORATION, and is used under license.
- rekordbox and WeDJ are registered trademarks or trademarks of Pioneer DJ Corporation.
- djay and vjay are trademarks of algoriddim GmbH.
- Windows is a registered trademark of Microsoft Corporation in the United States and other countries.
- iPhone, iPad, iPad Air, iPod touch, Finder, Mac, macOS, and OS X are trademarks of Apple Inc., registered in the U.S. and other countries.
- iPad mini and iPad Pro are trademarks of Apple Inc.
- App Store is a service mark of Apple Inc.
- "Made for iPod," "Made for iPhone," and "Made for iPad" mean that an electronic accessory has been designed to connect specifically to iPod, iPhone, or iPad, respectively, and has been certified by the developer to meet Apple performance standards. Apple is not responsible for the operation of this device or its compliance with safety and regulatory standards. Please note that the use of this accessory with iPod, iPhone, or iPad may affect wireless performance.



- iOS is a trademark on which Cisco holds the trademark right in the US and certain other countries.
- Intel and Intel Core are trademarks of Intel Corporation in the U.S. and/or other countries.
- ASIO is a trademark of Steinberg Media Technologies GmbH.

The names of companies and products mentioned herein are trademarks or registered trademarks of their respective owners.

Cautions on copyrights

rekordbox and WeDJ are registered trademarks or trademarks of Pioneer DJ Corporation.

- When coded data, etc., for protecting the copyright is embedded in the music contents, it may not be possible to operate the program normally.
- When rekordbox detects that coded data, etc., for protecting the copyright is embedded in the music contents, processing (playback, reading, etc.) may stop.

Recordings you have made are for your personal enjoyment and according to copyright laws may not be used without the consent of the copyright holder.

- Music recorded from CDs, etc., is protected by the copyright laws of individual countries and by international treaties. It is the full responsibility of the person who has recorded the music to ensure that it is used legally.
- When handling music downloaded from the Internet, etc., it is the full responsibility of the person who has downloaded the music to ensure that it is used in accordance with the contract concluded with the download site.

— The specifications and design of this product are subject to change without notice.

© 2016 Pioneer DJ Corporation. All rights reserved.

<DR11415-B>