

Pioneer Dj

DJ Controller

DDJ-WeGO 4

DDJ-WEGO4

<http://pioneerdj.com/support/>
<http://rekordbox.com/>

For FAQs and other support information for this product, visit the above site.

Operating Instructions (Quick Start Guide)

IMPORTANT



The lightning flash with arrowhead symbol, within an equilateral triangle, is intended to alert the user to the presence of uninsulated "dangerous voltage" within the product's enclosure that may be of sufficient magnitude to constitute a risk of electric shock to persons.

CAUTION

**RISK OF ELECTRIC SHOCK
DO NOT OPEN**

CAUTION:
TO PREVENT THE RISK OF ELECTRIC SHOCK, DO NOT REMOVE COVER (OR BACK). NO USER-SERVICEABLE PARTS INSIDE. REFER SERVICING TO QUALIFIED SERVICE PERSONNEL.



The exclamation point within an equilateral triangle is intended to alert the user to the presence of important operating and maintenance (servicing) instructions in the literature accompanying the appliance.

D3-4-2-1-1b_A1_En

WARNING

This equipment is not waterproof. To prevent a fire or shock hazard, do not place any container filled with liquid near this equipment (such as a vase or flower pot) or expose it to dripping, splashing, rain or moisture.

D3-4-2-1-3_A1_En

WARNING

To prevent a fire hazard, do not place any naked flame sources (such as a lighted candle) on the equipment.

D3-4-2-1-7a_A1_En

Operating Environment

Operating environment temperature and humidity: +5 °C to +35 °C (+41 °F to +95 °F); less than 85 %RH (cooling vents not blocked)

Do not install this unit in a poorly ventilated area, or in locations exposed to high humidity or direct sunlight (or strong artificial light).

D3-4-2-1-7c*_A2_En

CAUTION

This product is evaluated in moderate climate condition.

D3-8-2-1-7b_A1_En

CAUTION

The **STANDBY/ON** switch on this unit will not completely shut off all power from the AC outlet. Since the power cord serves as the main disconnect device for the unit, you will need to unplug it from the AC outlet to shut down all power. Therefore, make sure the unit has been installed so that the power cord can be easily unplugged from the AC outlet in case of an accident. To avoid fire hazard, the power cord should also be unplugged from the AC outlet when left unused for a long period of time (for example, when on vacation).

D3-4-2-2-2a*_A1_En

When using this product, confirm the safety information shown on the bottom of the unit.

D3-4-2-2-4_B1_En

This product is for general household purposes. Any failure due to use for other than household purposes (such as long-term use for business purposes in a restaurant or use in a car or ship) and which requires repair will be charged for even during the warranty period.

K041_A1_En

The Safety of Your Ears is in Your Hands

Get the most out of your equipment by playing it at a safe level – a level that lets the sound come through clearly without annoying blaring or distortion and, most importantly, without affecting your sensitive hearing. Sound can be deceiving. Over time, your hearing "comfort level" adapts to higher volumes of sound, so what sounds "normal" can actually be loud and harmful to your hearing. Guard against this by setting your equipment at a safe level BEFORE your hearing adapts.

ESTABLISH A SAFE LEVEL:

- Set your volume control at a low setting.
- Slowly increase the sound until you can hear it comfortably and clearly, without distortion.
- Once you have established a comfortable sound level, set the dial and leave it there.

BE SURE TO OBSERVE THE FOLLOWING GUIDELINES:

- Do not turn up the volume so high that you can't hear what's around you.
- Use caution or temporarily discontinue use in potentially hazardous situations.
- Do not use headphones while operating a motorized vehicle; the use of headphones may create a traffic hazard and is illegal in many areas.

S001a_A1_En

POWER-CORD CAUTION

Handle the power cord by the plug. Do not pull out the plug by tugging the cord and never touch the power cord when your hands are wet as this could cause a short circuit or electric shock. Do not place the unit, a piece of furniture, etc., on the power cord, or pinch the cord. Never make a knot in the cord or tie it with other cords. The power cords should be routed such that they are not likely to be stepped on. A damaged power cord can cause a fire or give you an electrical shock. Check the power cord once in a while. When you find it damaged, ask your nearest service center or your dealer for a replacement.

S002*_A1_En

The graphical symbol  placed on the product means alternating current.

The graphical symbol  placed on the product means direct current.

The graphical symbol  placed on the product means Class II equipment.

D3-8-2-4_A1_En

For U.S.A.

IMPORTANT SAFETY INSTRUCTIONS

- 1) Read these instructions.
- 2) Keep these instructions.
- 3) Heed all warnings.
- 4) Follow all instructions.
- 5) Do not use this apparatus near water.
- 6) Clean only with dry cloth.
- 7) Do not block any ventilation openings. Install in accordance with the manufacturer's instructions.
- 8) Do not install near any heat sources such as radiators, heat registers, stoves, or other apparatus (including amplifiers) that produce heat.
- 9) Do not defeat the safety purpose of the polarized or grounding-type plug. A polarized plug has two blades with one wider than the other. A grounding type plug has two blades and a third grounding prong. The wide blade or the third prong are provided for your safety. If the provided plug does not fit into your outlet, consult an electrician for replacement of the obsolete outlet.
- 10) Protect the power cord from being walked on or pinched particularly at plugs, convenience receptacles, and the point where they exit from the apparatus.
- 11) Only use attachments/accessories specified by the manufacturer.
- 12) Use only with the cart, stand, tripod, bracket, or table specified by the manufacturer, or sold with the apparatus. When a cart is used, use caution when moving the cart/apparatus combination to avoid injury from tip-over.
- 13) Unplug this apparatus during lightning storms or when unused for long periods of time.
- 14) Refer all servicing to qualified service personnel. Servicing is required when the apparatus has been damaged in any way, such as power-supply cord or plug is damaged, liquid has been spilled or objects have fallen into the apparatus, the apparatus has been exposed to rain or moisture, does not operate normally, or has been dropped.



D3-7-13-69_En

NOTE:

This equipment has been tested and found to comply with the limits for a Class B digital device, pursuant to Part 15 of the FCC Rules. These limits are designed to provide reasonable protection against harmful interference in a residential installation. This equipment generates, uses, and can radiate radio frequency energy and, if not installed and used in accordance with the instructions, may cause harmful interference to radio communications. However, there is no guarantee that interference will not occur in a particular installation. If this equipment does cause harmful interference to radio or television reception, which can be determined by turning the equipment off and on, the user is encouraged to try to correct the interference by one or more of the following measures:

- Reorient or relocate the receiving antenna.
- Increase the separation between the equipment and receiver.
- Connect the equipment into an outlet on a circuit different from that to which the receiver is connected.
- Consult the dealer or an experienced radio/TV technician for help.

D8-10-1-2_A1_En

FEDERAL COMMUNICATIONS COMMISSION DECLARATION OF CONFORMITY

This device complies with part 15 of the FCC Rules. Operation is subject to the following two conditions: (1) This device may not cause harmful interference, and (2) this device must accept any interference received, including interference that may cause undesired operation.

Product Name: DJ Controller

Model Number: DDJ-WEGO4-K, DDJ-WEGO4-W

Responsible Party Name: PIONEER ELECTRONICS (USA) INC.
SERVICE SUPPORT DIVISION

Address: 1925 E. DOMINGUEZ ST. LONG BEACH, CA 90810-1003, U.S.A.

Phone: 1-800-421-1404

URL: <http://www.pioneerelectronics.com>

D8-10-4*_C1_En

Information to User

Alterations or modifications carried out without appropriate authorization may invalidate the user's right to operate the equipment.

D8-10-2_A1_En

IMPORTANT NOTICE

THE MODEL NUMBER AND SERIAL NUMBER OF THIS EQUIPMENT ARE ON THE REAR OR BOTTOM. RECORD THESE NUMBERS ON PAGE 19 FOR FUTURE REFERENCE.

D36-AP9-3*_A1_En

CAUTION

This product satisfies FCC regulations when shielded cables (with Ferrite-cores attached) and connectors are used to connect the unit to other equipment. To prevent electromagnetic interference with electric appliances such as radios and televisions, use shielded cables (with Ferrite-cores attached) and connectors for connections.

D8-10-3b_A1_En

Before start

How to read this manual

- Thank you for buying this Pioneer DJ product.
This guide provides a brief description of the procedures up until connecting the unit to your computer and outputting audio. For the detailed procedures, refer to the operating instructions.
Be sure to read both this leaflet and the operating instructions! Both documents include important information that you must understand before using this product.
After you have finished reading the instructions, put them away in a safe place for future reference.
— For how to view the operating instructions, see *Viewing the manuals* (p.5).
- In this manual, names of menus displayed on the product and on the computer screen, as well as names of buttons and terminals, etc., are indicated within brackets. (E.g.: **[File]**, **[CUE]** button, and **[PHONES]** output terminals)
- Please note that the screens and specifications of the software described in this manual as well as the external appearance and specifications of the hardware are currently under development and may differ from the final specifications.
- Please note that depending on the operating system version, web browser settings, etc., operation may differ from the procedures described in this manual.
- Please note that the language of the software screens described in this Operating Instructions may differ from the language of the actual screens.

Features

This unit is a compact size DJ Controller that enables DJ performances using dynamic sound changes and a wide variety of light changes. DJing can be enjoyed not just with a computer but also with an iPhone / iPad. The "PULSE CONTROL" function is provided to enable a wide variety of changes in light color using the LEDs of this unit. Furthermore, an AC adapter and USB bus power are supported for the power source of this unit, enabling enjoyment of a DJ life that matches the preferences and style of the user.

What's in the box

- Operating Instructions (Quick Start Guide) (This document)
- AC adapter
- Power cord
- USB cable
- rekordbox dj license key card
- VIRTUAL DJ LE 8 license key card

Caution

The license key cannot be reissued. Be careful not to lose it.

Viewing the manuals

Viewing the Latest Version of the Operating Instructions

- 1 Launch a web browser on the computer and access the Pioneer DJ site below.
<http://pioneerdj.com/>
- 2 Click **[Support]**.
- 3 Click **[FIND TUTORIAL & MANUALS]**.
- 4 Click **[DDJ-WeGO4]** in the **[DJ CONTROLLER]** category.

- 5 Click the required language from the Operating Instructions list.

Viewing the Operating Instructions of rekordbox

- 1 Launch a web browser on the computer and access the rekordbox product site below.
<http://rekordbox.com/>
- 2 Click **[Support]**.
- 3 Click **[Manual]**.
- 4 Click the required language of the manual.
 - For inquiries on rekordbox, see the rekordbox product site indicated above.

About WeDJ for iPhone / iPad

- WeDJ for iPhone / iPad is an application that enables DJ performances with an iPhone / iPad.
- WeDJ for iPhone / iPad can be purchased from the App Store.

System requirements

	WeDJ for iPad	WeDJ for iPhone
iOS	iOS 10, 9, 8	iOS 10, 9, 8
Compatible models	iPad Pro (9.7-inch), iPad Air 2, iPad Air, iPad mini 4, iPad mini 3, iPad mini 2	iPhone 7, iPhone 7 Plus, iPhone 6s, iPhone 6s Plus, iPhone 6, iPhone 6 Plus, iPhone SE, iPhone 5s

- For information on the latest system requirements, compatibility, and supported operating systems, see **[DDJ-WeGO4]** of the **[DJ CONTROLLER]** category from the **[SOFTWARE INFORMATION]** page of the Pioneer DJ support site below.
<http://www.pioneerdj.com/en/support/software-information/>
- There is no guarantee that operation will be possible on all iPhones and iPads meeting the above system requirements.
- Depending on the power-saving settings and other conditions of the iPhone or iPad, performance may be insufficient.
- Problems may occur with operation depending on the other software that you use.
- For the latest system requirements for WeDJ for iPhone / iPad, check the App Store.
- An Internet connection is required to access App Store.

About rekordbox

- rekordbox is a composite software that enables track management and DJ performances.
- The DJ performance function of rekordbox is called rekordbox dj. Enter the license key shown on the rekordbox dj license key card included with this product to use rekordbox dj.

Minimum operating environment

Supported operating systems	CPU and required memory
Mac: macOS Sierra 10.12, OS X 10.11/10.10/10.9 (latest update)	Intel® processor Core™ i3/i5/i7, Intel® processor Core™ 2 Duo 4 GB or more of RAM
Windows: 32-bit version or 64-bit version of Windows 10/Windows 8.1/Windows 7 (latest service pack)	Intel® processor Core™ i3/i5/i7, Intel® processor Core™ 2 Duo 4 GB or more of RAM

Others

USB port	A USB 2.0 port is required to connect the computer with this unit.
Display resolution	Resolution of 1 280 x 768 or greater
Internet connection	An Internet connection is required for registering the rekordbox user account and downloading the software.

- For information on the latest system requirements, compatibility, and supported operating systems of rekordbox, see [System Requirements] on the rekordbox product site below.
<http://rekordbox.com/>
- Operation is not guaranteed on all computers, even if all the required operating environment conditions indicated here are fulfilled.
- Depending on the computer's power-saving settings, etc., the CPU and hard disk may not provide sufficient processing capabilities. For notebook computers in particular, make sure the computer is in the proper conditions to provide constant high performance (for example by keeping the AC power connected) when using rekordbox.
- Use of the Internet requires a separate contract with a provider offering Internet services and payment of provider fees.
- Use the latest version/service pack of the operating system.

Names of Parts

For details, see this product's operating instructions.

Rear panel

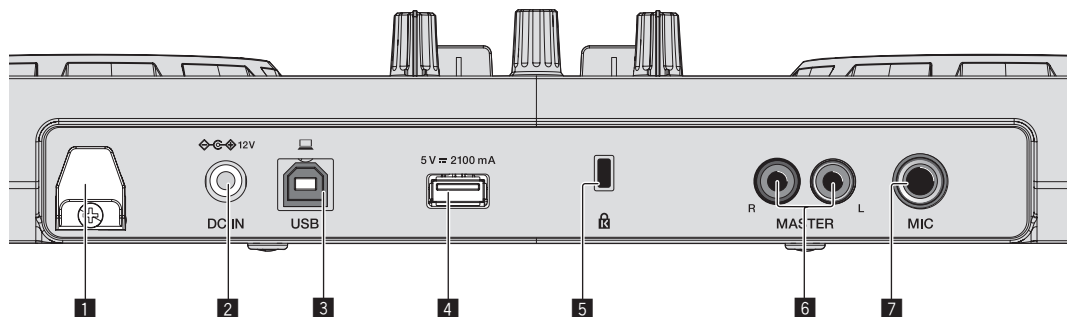

- 1 Cord hook**
- 2 DC IN terminal**
- 3 USB-B terminal**
- 4 USB-A terminal**
- 5 Kensington security slot**
- 6 MASTER terminals**
- 7 MIC input terminal (1/4" TS jack)**
* Supports unbalanced input only.

Cautions for using the iPhone / iPad stand



- This stand is exclusively for use with an iPhone / iPad. Do not place a tablet other than a supported model or a large device on the stand.
- Set the iPhone / iPad in the horizontal direction on the stand. It may be unstable if set in the vertical direction.
- Do not apply excessive force to the stand. Doing so may damage this unit.
- Please note that Pioneer will accept no responsibility whatsoever for damage to or malfunction of the device, injury, etc., due to the device falling, etc.
- Do not move the unit with an iPhone / iPad placed on the stand. The iPhone / iPad may fall off.
- If there is a cover on the iPhone / iPad, remove the cover before placing the iPhone / iPad on the stand. If the cover is left on, the iPhone / iPad may be unstable.

Control Panel

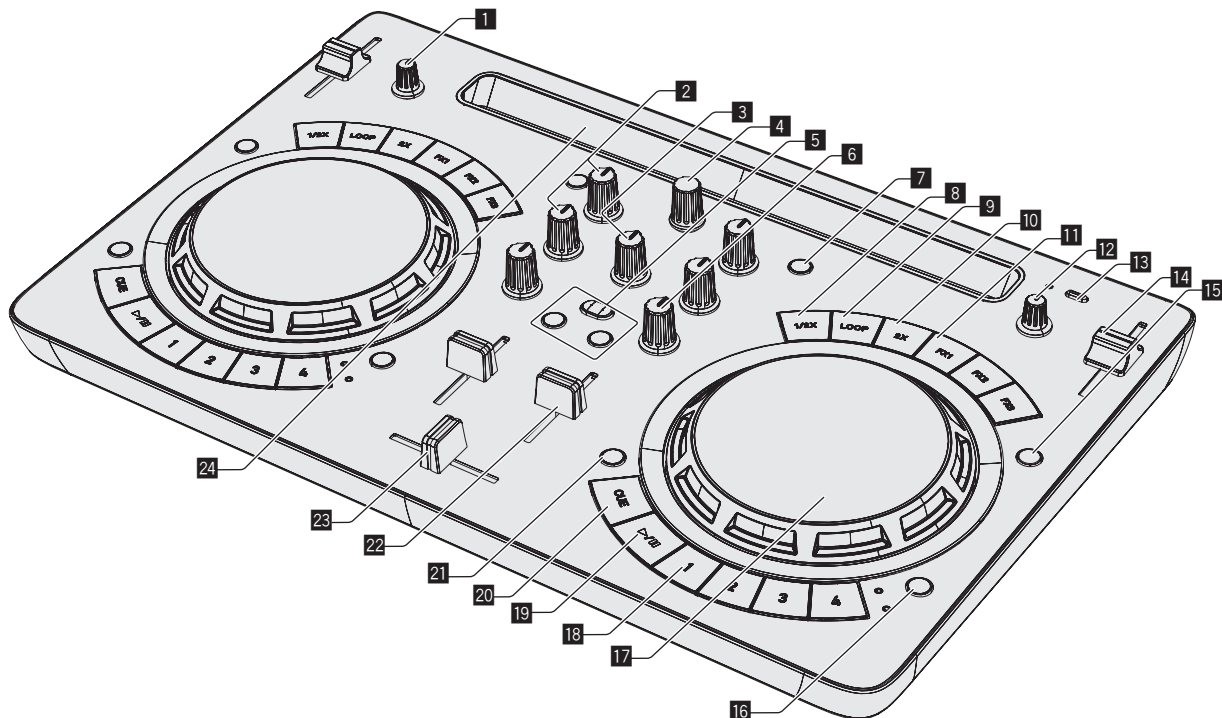

1 MIC LEVEL control

* When not using a microphone, set the volume to the minimum level.

2 EQ (HI, LOW) controls

3 HEADPHONE LEVEL control

4 Rotary selector

5 HEADPHONES CUE MASTER/1/2 selection button

6 FILTER control

7 LOAD button

8 Loop half button

9 Loop button

10 Loop double button

11 FX button

12 MASTER LEVEL control

13 STANDBY/ON button

- ❖ When unit power is on standby
 - Press: Turn on the power of this unit.
- ❖ When unit power is on
 - Press for over 1 second: Set this unit's power to the standby mode.

14 TEMPO slider

15 SYNC button

16 HOT CUE/SAMPLER mode switching button

17 Jog dial

18 Performance buttons

19 PLAY/PAUSE button

20 CUE button

21 SHIFT button

22 Channel fader

23 Crossfader

24 iPhone / iPad stand

Side panel

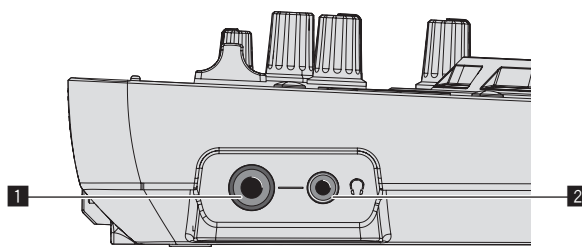

1 PHONES output terminal (1/4" stereo phone jack)

2 PHONES output terminal (3.5-mm stereo mini jack)

Setup Procedure

When using iPhone / iPad

The following explanation utilizes WeDJ for iPhone / iPad as an example.

STEP 1

Downloading WeDJ for iPhone / iPad

➡ page 9

Download WeDJ for iPhone / iPad from the App Store

- WeDJ for iPhone / iPad is a paid app.



STEP 2

Connecting the peripheral devices to this unit

➡ page 10

- 1 Connect speakers with a built-in amplifier.
- 2 Connect with an iPhone / iPad.

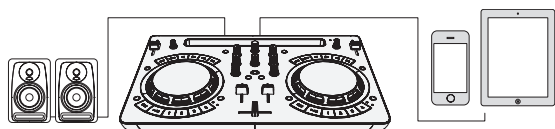

STEP 3

Starting WeDJ for iPhone / iPad playing tracks

➡ page 11

- 1 Launch WeDJ for iPhone / iPad.
- 2 Load and play tracks.

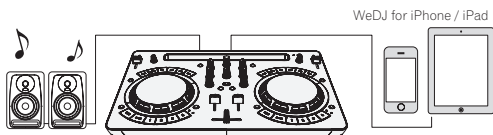

When using Mac / PC

The following explanation utilizes rekordbox as an example.

STEP 1

Installing rekordbox

➡ page 12

Accessing the rekordbox product site and installing the rekordbox software

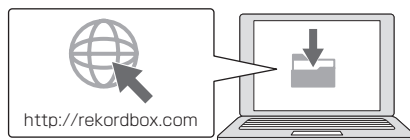

STEP 2

Connecting the peripheral devices to this unit

➡ page 13

- 1 Connect speakers with a built-in amplifier.
 - This is not necessary when outputting sound from the computer's speakers.
- 2 Connecting with a computer

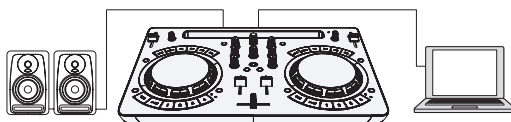

STEP 3

Starting rekordbox and playing tracks

➡ page 14

- 1 Start rekordbox and configure the settings.
- 2 Load and play tracks.

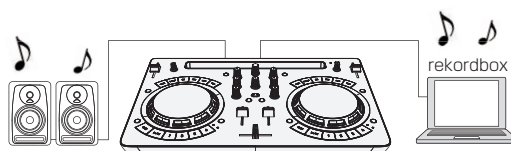

STEP 1 Downloading WeDJ for iPhone / iPad

Download WeDJ for iPhone / iPad from the App Store

WeDJ for iPhone / iPad is a paid app.

STEP 2 Connecting the peripheral devices to this unit

Connecting speakers with a built-in amplifier to this unit with an audio cable (RCA)

Connect speakers with a built-in amplifier, power amplifier, etc. to the [MASTER] output terminals.

- An audio cable (RCA) is not included with this product. Please provide it yourself separately.

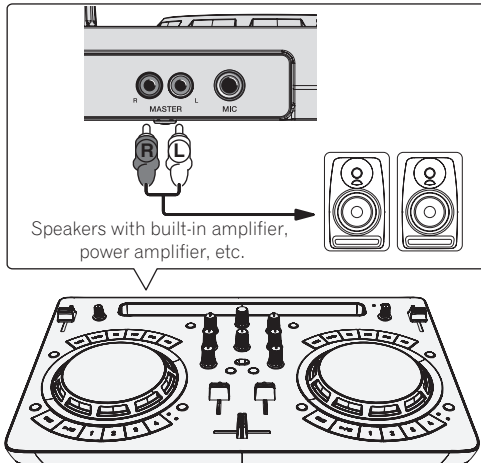

- For details on connecting the input/output terminals, see the Operating Instructions.
- Set the volume of the device connected to the [MASTER] terminals (speakers with built-in amplifier, power amplifier, etc.) to an appropriate level. Note that the output sound may be loud if the volume is set too high.

Connect with an iPhone / iPad.

Connect this unit and the iPhone / iPad using the cable included with the iPhone / iPad.

- Be sure to connect directly using the cable included with the iPhone / iPad. A USB hub cannot be used.

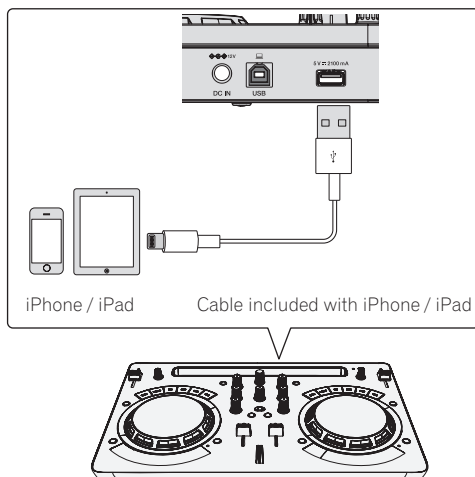

Connect the AC adapter

1 Connect the included DC plug of the AC adapter to this unit and then connect the power cord.

- Connect the power cord after all the connections between devices have been completed.
- Be sure to use the power cord and AC adapter included with this product.

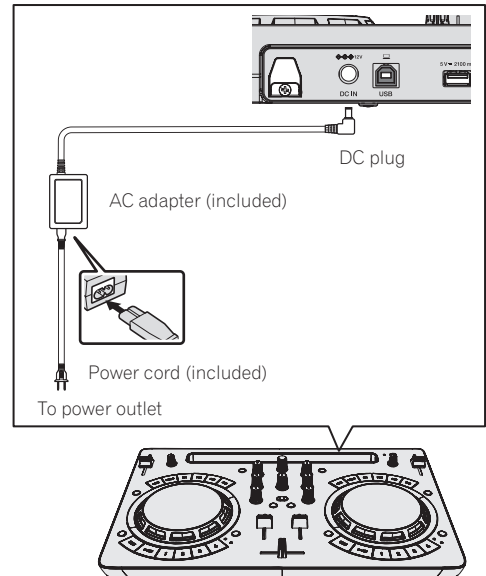

2 Turn on the power of the iPhone / iPad.

3 Press the [STANDBY/ON] button of this unit to turn on the power of the unit.

4 Turn on the power of the device (speakers with built-in amplifier, power amplifier, etc.) connected to the output terminals.

STEP 3 Starting WeDJ for iPhone / iPad and playing tracks

Launch WeDJ for iPhone / iPad.

Tap the WeDJ for iPhone / iPad icon.

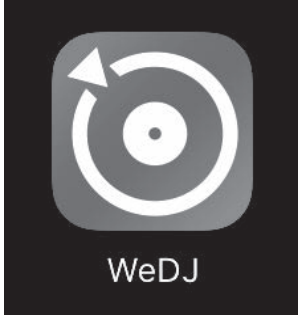

Loading tracks into a deck

The following describes the procedure for loading tracks into deck 1 (left side) as an example.

- 1 Turn the rotary selector to switch to the browse screen.
- 2 Turn the rotary selector to move the cursor to [TRACKS] in the browse screen.
- 3 Press the rotary selector to move the cursor to the track list.
- 4 Turn the rotary selector to select a track in [TRACKS] and then press the [LOAD] button of deck 1 (left side).
The track is loaded into the deck.

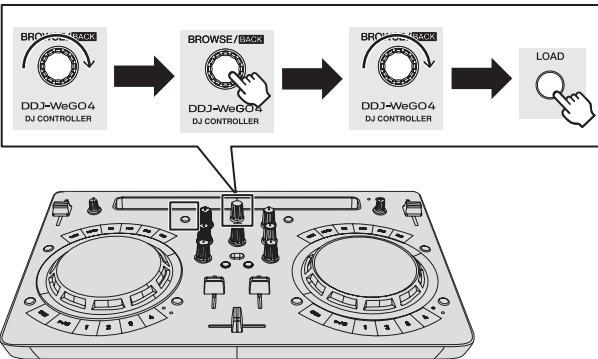

Playing a music file

The following describes the procedure for outputting the sound of deck 1 (left side) as an example.

- 1 Set the positions of the controls, etc., as shown below.

Names of controls, etc.	Position
EQ (HI, LOW) controls	Center
FILTER control	Center
Channel fader	Moved forward
MASTER LEVEL control	Turned fully counterclockwise
Crossfader	Center

- 2 Press the [PLAY/PAUSE▶/II] button to play the track.

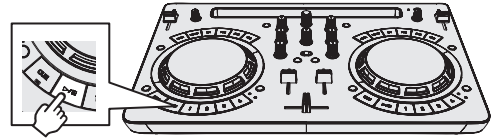

- 3 Move the channel fader away from you.

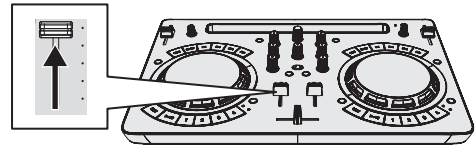

- 4 Turn the [MASTER LEVEL] control to adjust the audio level of the speakers.

Adjust the audio level output from the [MASTER] output terminals to an appropriate level.

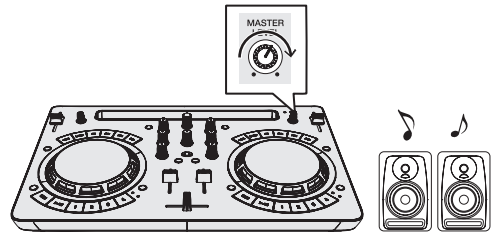

Sound is output from the speakers.

STEP 1 Installing rekordbox

If this is your first time to use rekordbox or if you are using rekordbox 3 or earlier, follow this procedure to install the software.

If you have already installed rekordbox 4, update it to the latest version.

Obtaining the rekordbox software

1 Access the rekordbox product site.

<https://rekordbox.com/en/store/>

- The page content is subject to change without notice.

2 Check the Get Started guide and then click [Free To Download].



3 Carefully read the terms of the software license agreement and select the [Agree] check box if you agree.

When the check box is selected, [Download] becomes clickable and downloading of rekordbox begins when it is clicked.

Installing the rekordbox software

The installation procedure depends on the operating system (OS) on the computer you are using.

Do not connect this unit and the computer until installation is completed.

Installation Procedure (Mac)

1 Unzip the downloaded rekordbox software file.

2 Double-click the unzipped software file to launch the installer.

3 Read the terms of the license agreement carefully, and if you agree, click [Agree].

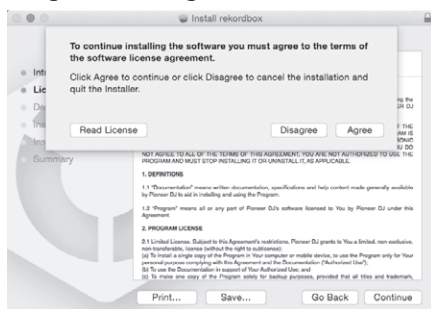

- If you do not agree to the contents of the license agreement, click [Disagree] to quit installation.

4 If the installation completion screen appears, click [Close] to close the rekordbox installer.

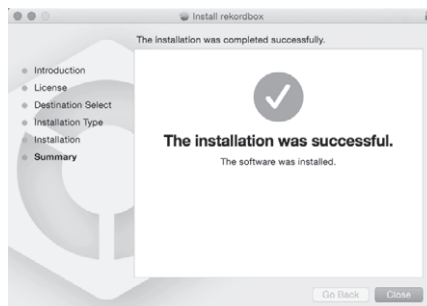

Installation Procedure (Windows)

- Log on as the user which was set as the computer's administrator before installing.

1 Unzip the downloaded rekordbox software file.

2 Double-click the unzipped software file to launch the installer.

3 Read the terms of the license agreement carefully, and if you agree, select [I accept the terms in the License Agreement], then click [Next].

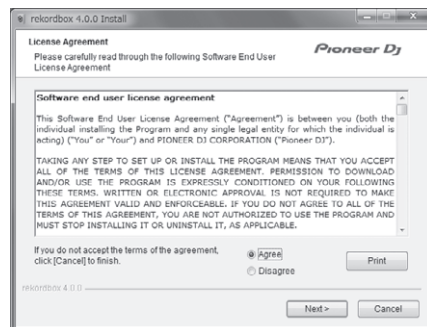

- If you do not agree to the contents of the license agreement, click [Cancel] to cancel installation.
- After the installation destination is specified, the installation starts. The message of successful installation appears once installation is completed.

4 Click [Finish] to quit the rekordbox installer.

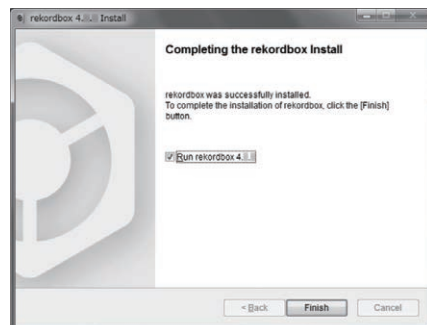

The installation is now complete.

STEP 2 Connecting the peripheral devices to this unit

Connecting speakers with a built-in amplifier to this unit with an audio cable (RCA)

Connecting with speakers with a built-in amplifier is not necessary when outputting sound from the computer's speakers. Connect this unit and the computer using a USB cable as described in the procedure of *Connecting with a computer* below.

Connect speakers with a built-in amplifier, power amplifier, etc. to the [MASTER] output terminals.

- An audio cable (RCA) is not included with this product. Please provide it yourself separately.

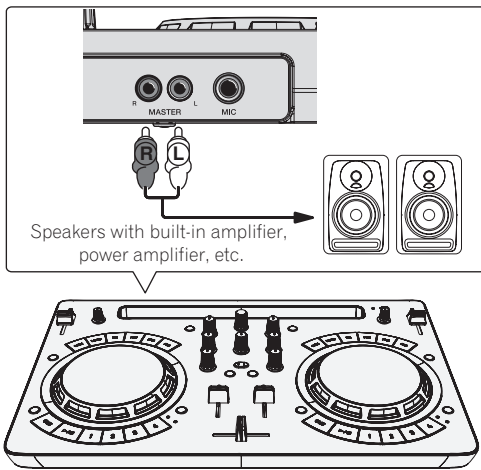

- For details on connecting the input/output terminals, see the Operating Instructions.
- Set the volume of the device connected to the [MASTER] terminals (speakers with built-in amplifier, power amplifier, etc.) to an appropriate level. Note that the output sound may be loud if the volume is set too high.

Connecting with a computer

Connect this unit to your computer via a USB cable.

- Be sure to connect directly using the USB cable included with this product. A USB hub cannot be used.

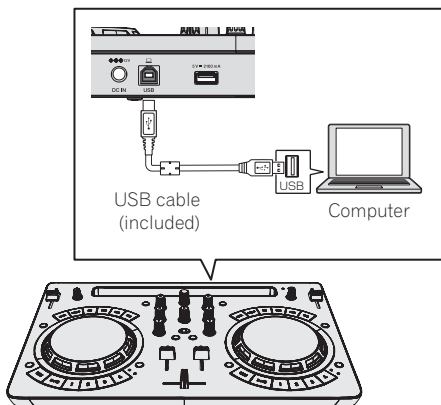

Connect the AC adapter

1 Connect the included DC plug of the AC adapter to this unit and then connect the power cord.

- Connection is not necessary when operating with bus power supplied from a USB port of the computer.
- Connect the power cord after all the connections between devices have been completed.
- Be sure to use the power cord and AC adapter included with this product.

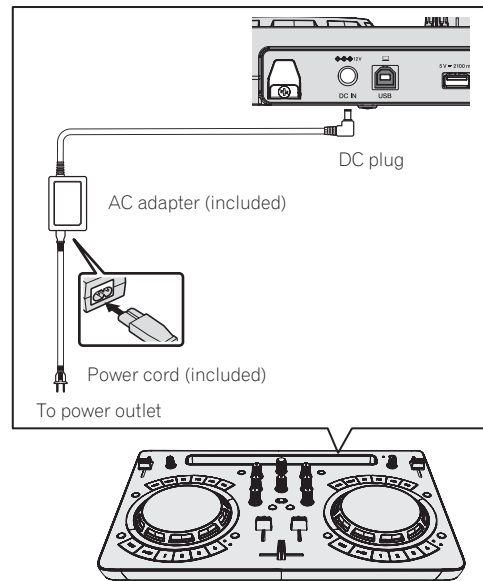

2 Turn on the computer's power.

3 Press the [STANDBY/ON] button of this unit to turn on the power of the unit.

4 Turn on the power of the device (speakers with built-in amplifier, power amplifier, etc.) connected to the output terminals.

STEP 3 Starting rekordbox and playing tracks

Launching rekordbox

1 Click the [rekordbox] icon.

- For macOS Sierra 10.12 and OS X 10.11/10.10/10.9
Open the [Application] folder in Finder and then double-click the [rekordbox] icon in the [rekordbox4] folder.
- For Windows 10/8.1
From [Apps view], click the [rekordbox] icon.
- For Windows 7
From the Windows [Start] menu, click the [rekordbox] icon under [All Programs] > [Pioneer] > [rekordbox X.X.X].

2 Enter the account information.

If you already have an account, enter the account information and then click [Setup].

If you do not have an account, click [Create an account] to go to the web page for creating an account and then create an account.

- For details on the account creation procedure, access the rekordbox product site below and see the rekordbox Operating Instructions in [Support].
<http://rekordbox.com/>

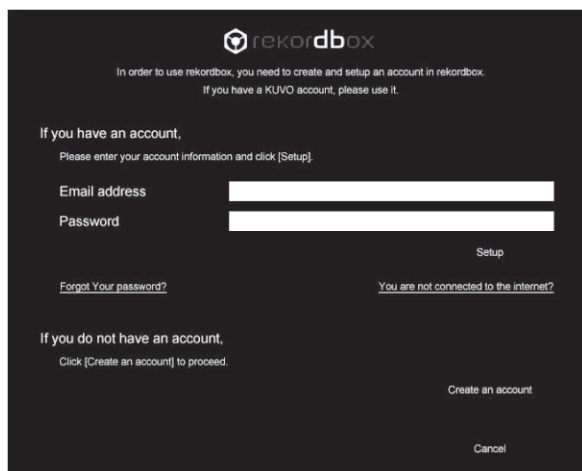

3 Select the usage method.

Click the [DJ performance] icon.

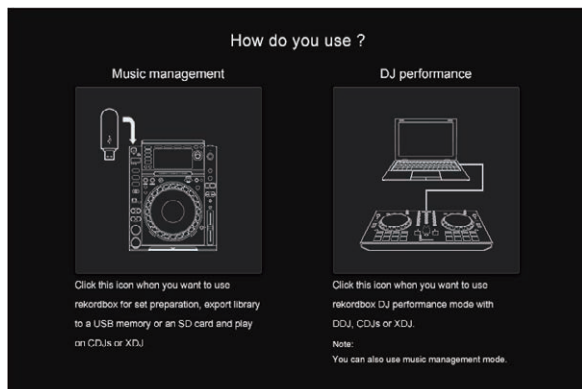

4 Enter the license key and activate the software.

Enter the license key shown on the rekordbox dj license key card included with this product and activate the software following the instructions on the screen.

- For details on the activation work procedure, access the rekordbox product site below and see the rekordbox operating instructions in [Support].
<http://rekordbox.com/>

Installing the driver software

There is no need to install the driver software when using Mac. Proceed to *Confirm the sending of rekordbox customer usage conditions*. This unit functions as an audio device conforming to the ASIO standards.

1 Disconnect the USB cable connecting this unit to the computer.

2 Select [DDJ-WeGO4] from the pull-down menu and click [Install] in the audio driver installation screen.

- For details on the installation procedure when [Skip] was performed, see the Operating Instructions.

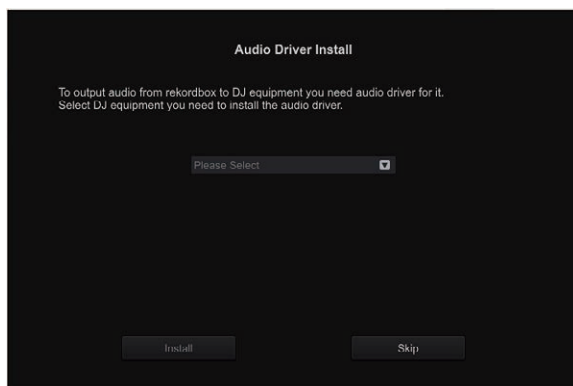

3 Install the audio driver following the instructions on the screen.

4 Connect this unit and the computer directly using the included USB cable.

Confirm the sending of rekordbox customer usage conditions

If you wish to cooperate in the sending of customer usage conditions for the purpose of improving the quality and specifications of rekordbox, click [Yes], and click [No] if you not wish to send them.

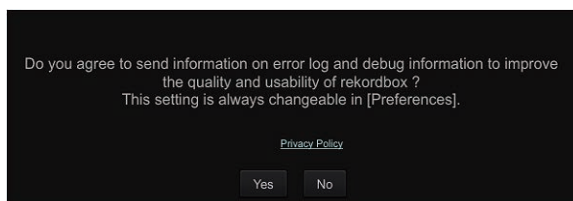

The preparation for using rekordbox is now complete. rekordbox is launched.

Set the audio

Start rekordbox to display [Select Speaker] while this unit is connected. Select one of the options to match your audio environment and then click [OK].

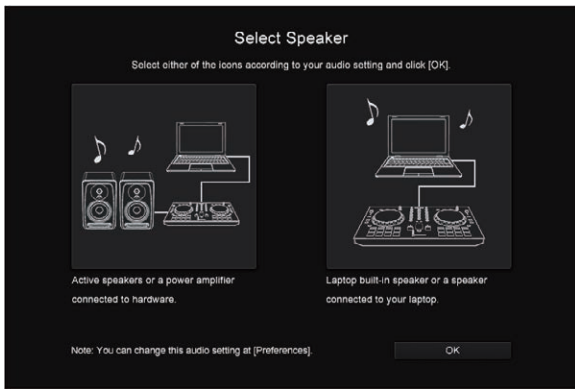

Adding track files to [Collection]

[Collection] is a screen for displaying a list of the track files managed by rekordbox.

Registering the track files on the computer as the music collection of rekordbox and then analyzing them enables those tracks to be used with rekordbox.

1 Click [Collection] in the tree view.

A list of the tracks registered in [Collection] is displayed.

2 Open Finder or Windows Explorer, then drag and drop track files or folders including track files to the track list.

The track files are added to [Collection], and the waveform information analysis of the track files starts. Wait until the analysis of all the track files is finished.



Loading tracks into a deck

The following describes the procedure for loading tracks into deck 1 (left side) as an example.

Turn the rotary selector to select a track in [Collection] and then press the [LOAD] button of deck 1 (left side).

The track is loaded into the deck.

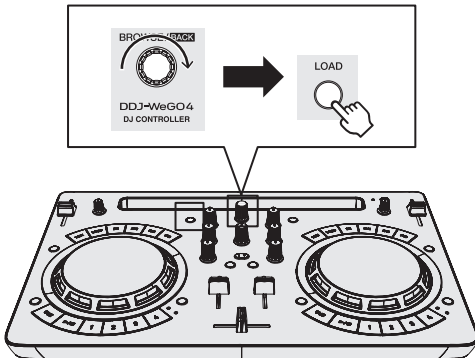

Playing a music file

The following describes the procedure for outputting the sound of deck 1 (left side) as an example.

1 Set the positions of the controls, etc., as shown below.

Names of controls, etc.	Position
EQ (HI, LOW) controls	Center
FILTER control	Center
Channel fader	Moved forward
MASTER LEVEL control	Turned fully counterclockwise
Crossfader	Center

2 Press the [PLAY/PAUSE▶/II] button to play the track.

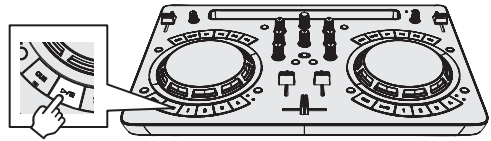

3 Move the channel fader away from you.

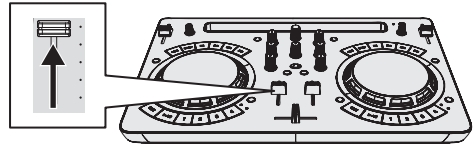

4 Turn the [MASTER LEVEL] control to adjust the audio level of the speakers.

Adjust the audio level output from the [MASTER] output terminals to an appropriate level.

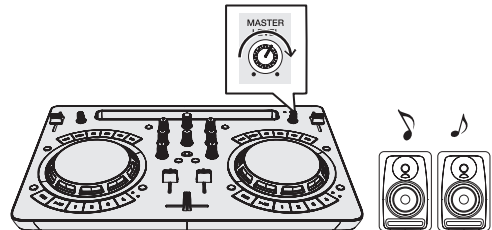

- Sound is output from the speakers according to your audio environment.

Additional information

About DJ software other than WeDJ for iPhone / iPad and rekordbox

For details on how to use DJ software other than WeDJ for iPhone / iPad and rekordbox, see the Operating Instructions of this unit.

For the latest support status of DJ software other than WeDJ for iPhone / iPad and rekordbox, see [DDJ-WeGO4] of the [DJ CONTROLLER] category from the [SOFTWARE INFORMATION] page of the Pioneer DJ support site below.
<http://www.pioneerdj.com/en/support/software-information/>

Troubleshooting

- If you think that there is something wrong with this unit, check the items in the "Troubleshooting" section of this unit's operating instructions and access the Pioneer DJ site and check [FAQ] for the [DDJ-WeGO4].
<http://pioneerdj.com/>
Sometimes the problem may lie in another component. Inspect the other components and electrical appliances being used. If the problem cannot be rectified, ask your nearest service center or your dealer to carry out repair work.
- The player may not operate properly due to static electricity or other external influences. In such cases, normal operation may become possible if you turn the power off and then back on.

About trademarks and registered trademarks

- "Pioneer DJ" is a trademark of PIONEER CORPORATION, and is used under license.
- rekordbox and WeDJ are registered trademarks or trademarks of Pioneer DJ Corporation.
- Windows is a registered trademark of Microsoft Corporation in the United States and other countries.
- iPhone, iPad, iPad Air, Finder, Mac, macOS, and OS X are trademarks of Apple Inc., registered in the U.S. and other countries.
- iPad mini and iPad Pro are trademarks of Apple Inc.
- App Store is a service mark of Apple Inc.
- "Made for iPod," "Made for iPhone," and "Made for iPad" mean that an electronic accessory has been designed to connect specifically to iPod, iPhone, or iPad, respectively, and has been certified by the developer to meet Apple performance standards. Apple is not responsible for the operation of this device or its compliance with safety and regulatory standards. Please note that the use of this accessory with iPod, iPhone, or iPad may affect wireless performance.



- iOS is a trademark on which Cisco holds the trademark right in the US and certain other countries.
 - Intel and Intel Core are trademarks of Intel Corporation in the U.S. and/or other countries.
 - ASIO is a trademark of Steinberg Media Technologies GmbH.
- The names of companies and products mentioned herein are trademarks or registered trademarks of their respective owners.

Cautions on copyrights

rekordbox and WeDJ restrict playback and duplication of copyright-protected music content.

- When coded data, etc., for protecting the copyright is embedded in the music contents, it may not be possible to operate the program normally.
- When rekordbox detects that coded data, etc., for protecting the copyright is embedded in the music contents, processing (playback, reading, etc.) may stop.

Recordings you have made are for your personal enjoyment and according to copyright laws may not be used without the consent of the copyright holder.

- Music recorded from CDs, etc., is protected by the copyright laws of individual countries and by international treaties. It is the full responsibility of the person who has recorded the music to ensure that it is used legally.
- When handling music downloaded from the Internet, etc., it is the full responsibility of the person who has downloaded the music to ensure that it is used in accordance with the contract concluded with the download site.

Specifications

AC adapter

Power requirements	AC 120 V, 60 Hz
Rated current	0.6 A
Rated output.....	DC 12 V, 2 A
Power consumption (standby)	0.5 W

General – Main Unit

Power consumption	
When an AC adapter is used	
When connected to an iPhone / iPad	DC 12 V, 1 400 mA
When connected to a computer	DC 12 V, 300 mA
When using USB bus power.....	DC 5 V, 500 mA
Main unit weight	1.8 kg (4.0 lb)
Max. dimensions.....	380 mm (W) × 59 mm (H) × 240 mm (D) (15 in. (W) × 2.3 in. (H) × 9.4 in. (D))
Tolerable operating temperature	+5 °C to +35 °C (+41 °F to +95 °F)
Tolerable operating humidity	5 % to 85 % (no condensation)

Audio Section

Rated output level / Load impedance	
MASTER	2.1 Vrms / 10 k Ω
Total harmonic distortion (20 Hz to 20 kHzBW)	
USB	0.006 %
Frequency characteristic	
USB	20 Hz to 20 kHz
S/N ratio (rated output, A-WEIGHTED)	
USB	103 dB
MIC	65 dB
Input impedance	
MIC	3 k Ω or more
Output impedance	
MASTER	1 k Ω or less
PHONES	10 Ω or less
USB AUDIO	24 bit/Fs: 44.1 kHz, 24 bit/Fs: 48 kHz 16 bit/Fs: 44.1 kHz, 16 bit/Fs: 48 kHz

Input / Output terminals

MASTER output terminal	
RCA pin jacks.....	1 set
PHONES output terminal	
1/4" stereo phone jack.....	1 set
3.5 mm stereo mini jack	1 set
MIC input terminal	
1/4" TS jack.....	1 set
USB terminal	
Type A	1 set
B type.....	1 set

- For improvement purposes, specifications and design of this unit and the driver software are subject to change without notice.

Pioneer Dj

Pioneer DJ Americas, Inc.
LIMITED WARRANTY
WARRANTY VALID ONLY IN THE U.S.A. AND CANADA

WARRANTY

Pioneer DJ Americas, Inc. (PDJA) warrants that products distributed by PDJA in the U.S.A. and Canada that fail to function properly under normal use due to a manufacturing defect when installed and operated according to the owner's manual enclosed with the unit will be repaired or replaced with a unit of comparable value, at the option of PDJA, without charge to you for parts or actual repair work. Parts supplied under this warranty may be new or rebuilt at the option of PDJA.

THIS LIMITED WARRANTY APPLIES TO THE ORIGINAL OR ANY SUBSEQUENT OWNER OF THIS PIONEER DJ PRODUCT DURING THE WARRANTY PERIOD PROVIDED THE PRODUCT WAS PURCHASED FROM AN AUTHORIZED PIONEER DJ DISTRIBUTOR/DEALER IN THE U.S.A. OR CANADA. YOU WILL BE REQUIRED TO PROVIDE A SALES RECEIPT OR OTHER VALID PROOF OF PURCHASE SHOWING THE DATE OF ORIGINAL PURCHASE OR, IF RENTED, YOUR RENTAL CONTRACT SHOWING THE PLACE AND DATE OF FIRST RENTAL. IN THE EVENT SERVICE IS REQUIRED, THE PRODUCT MUST BE DELIVERED WITHIN THE WARRANTY PERIOD, TRANSPORTATION PREPAID, ONLY FROM WITHIN THE U.S.A. AS EXPLAINED IN THIS DOCUMENT. YOU WILL BE RESPONSIBLE FOR REMOVAL AND INSTALLATION OF THE PRODUCT. PDJA WILL PAY TO RETURN THE REPAIRED OR REPLACEMENT PRODUCT TO YOU WITHIN THE U.S.A.

PRODUCT WARRANTY PERIOD

	Parts	Labor
Audio and Video	1 Year	1 Year

The warranty period for retail customers who rent the product commences upon the date product is first put into use (a) during the rental period or (b) retail sale, whichever occurs first.

WHAT IS NOT COVERED

IF THIS PRODUCT WAS PURCHASED FROM AN UNAUTHORIZED DISTRIBUTOR, THERE ARE NO WARRANTIES, EXPRESS OR IMPLIED, INCLUDING THE IMPLIED WARRANTY OF MERCHANTABILITY AND THE IMPLIED WARRANTY OF FITNESS FOR A PARTICULAR PURPOSE AND THIS PRODUCT IS SOLD STRICTLY "AS IS" AND "WITH ALL FAULTS". PIONEER DJ SHALL NOT BE LIABLE FOR ANY CONSEQUENTIAL AND/OR INCIDENTAL DAMAGES.

THIS WARRANTY DOES NOT APPLY IF THE PRODUCT HAS BEEN SUBJECTED TO POWER IN EXCESS OF ITS PUBLISHED POWER RATING.

THIS WARRANTY DOES NOT COVER THE CABINET OR ANY APPEARANCE ITEM, USER ATTACHED ANTENNA, ANY DAMAGE TO RECORDS OR RECORDING TAPES OR DISCS, ANY DAMAGE TO THE PRODUCT RESULTING FROM ALTERATIONS, MODIFICATIONS NOT AUTHORIZED IN WRITING BY PIONEER DJ, ACCIDENT, MISUSE OR ABUSE, DAMAGE DUE TO LIGHTNING OR TO POWER SURGES, SUBSEQUENT DAMAGE FROM LEAKING, DAMAGE FROM INOPERATIVE BATTERIES, OR THE USE OF BATTERIES NOT CONFORMING TO THOSE SPECIFIED IN THE OWNER'S MANUAL.

THIS WARRANTY DOES NOT COVER THE COST OF PARTS OR LABOR WHICH WOULD BE OTHERWISE PROVIDED WITHOUT CHARGE UNDER THIS WARRANTY OBTAINED FROM ANY SOURCE OTHER THAN A PIONEER DJ AUTHORIZED SERVICE COMPANY OR OTHER DESIGNATED LOCATION. THIS WARRANTY DOES NOT COVER DEFECTS OR DAMAGE CAUSED BY THE USE OF UNAUTHORIZED PARTS OR LABOR OR FROM IMPROPER MAINTENANCE.

ALTERED, DEFACED, OR REMOVED SERIAL NUMBERS VOID THIS ENTIRE WARRANTY

NO OTHER WARRANTIES

PIONEER DJ LIMITS ITS OBLIGATIONS UNDER ANY IMPLIED WARRANTIES INCLUDING, BUT NOT LIMITED TO, THE IMPLIED WARRANTIES OF MERCHANTABILITY AND FITNESS FOR A PARTICULAR PURPOSE, TO A PERIOD NOT TO EXCEED THE WARRANTY PERIOD. NO WARRANTIES SHALL APPLY AFTER THE WARRANTY PERIOD. SOME STATES DO NOT ALLOW LIMITATIONS ON HOW LONG AN IMPLIED WARRANTY LASTS AND SOME STATES DO NOT ALLOW THE EXCLUSIONS OR LIMITATIONS OF INCIDENTAL OR CONSEQUENTIAL DAMAGES, SO THE ABOVE LIMITATIONS OR EXCLUSIONS MAY NOT APPLY TO YOU. THIS WARRANTY GIVES YOU SPECIFIC LEGAL RIGHTS AND YOU MAY HAVE OTHER RIGHTS WHICH MAY VARY FROM STATE TO STATE.

TO OBTAIN SERVICE

PDJA has appointed a number of Authorized Service Companies throughout the U.S.A. and Canada should your product require service. To receive warranty service you need to present your sales receipt or, if rented, your rental contract showing place and date of original owner's transaction. If shipping the unit you will need to package it carefully and send it, transportation prepaid by a traceable, insured method, to an Authorized Service Company. Package the product using adequate padding material to prevent damage in transit. The original container is ideal for this purpose. Include your name, address and telephone number where you can be reached during business hours.

On all complaints and concerns in the U.S.A. and Canada call Customer Support at 1-800-872-4159.

For hook-up and operation of your unit or to locate an Authorized Service Company, please call or write:
CUSTOMER SUPPORT
PIONEER ELECTRONICS (USA) INC.
P.O. BOX 1720
LONG BEACH, CALIFORNIA 90801
1-800-872-4159
<http://www.pioneerelectronics.com>

DISPUTE RESOLUTION

Following our response to any initial request to Customer Support, should a dispute arise between you and Pioneer DJ, Pioneer DJ makes available its Complaint Resolution Program to resolve the dispute. The Complaint Resolution Program is available to you without charge. You are required to use the Complaint Resolution Program before you exercise any rights under, or seek any remedies, created by Title I of the Magnuson-Moss Warranty-Federal Trade Commission Improvement Act, 15 U.S.C. 2301 *et seq.*

To use the Complaint Resolution Program call 1-800-872-4159 and explain to the customer service representative the problem you are experiencing, steps you have taken to have the product repaired during the warranty period and the name of the authorized Distributor/Dealer from whom the Pioneer DJ product was purchased. After the complaint has been explained to the representative, a resolution number will be issued. Within 40 days of receiving your complaint, Pioneer DJ will investigate the dispute and will either: (1) respond to your complaint in writing informing you what action Pioneer DJ will take, and in what time period, to resolve the dispute; or (2) respond to your complaint in writing informing you why it will not take any action.

RECORD THE PLACE AND DATE OF PURCHASE FOR FUTURE REFERENCE

Model No. _____ Serial No. _____ Purchase Date _____

Purchased From _____

KEEP THIS INFORMATION AND YOUR SALES RECEIPT IN A SAFE PLACE

UCP0516

To register your product, find the nearest authorized service location, to purchase replacement parts, operating instructions, or accessories, please go to one of following URLs :

Pour enregistrer votre produit, trouver le service après-vente agréé le plus proche et pour acheter des pièces de rechange, des modes d'emploi ou des accessoires, reportez-vous aux URL suivantes :

In the USA/Aux Etats-Unis or In Canada/Aux Canada
<http://www.pioneerelectronics.com>

S018_C1_EnFr_PSV

© 2016 Pioneer DJ Corporation.
All rights reserved.

Pioneer DJ Corporation

6F, Yokohama i-Mark Place, 4-4-5 Minatomirai, Nishi-ku, Yokohama, Kanagawa 220-0012 JAPAN

Pioneer DJ 株式会社

〒220-0012 神奈川県横浜市西区みなとみらい4丁目4番5号 横浜アイマークプレイス6階

Корпорация Пайонир Диджей

6F, Йокогама i-Mark Place, 4-4-5 Минатомирай, Ниси-ку, Йокогама, Канагава 220-0012 ЯПОНИЯ

Pioneer DJ Europe Limited

Anteros Building, Odyssey Business Park, West End Road, South Ruislip, Middlesex, HA4 6QQ, U.K. TEL: +44-203-7617-220

Pioneer DJ Americas, Inc.

2050 W. 190th Street, Suite 109, Torrance, CA 90504, U.S.A. TEL: +1 (424) 488-0480

PIONEER ELECTRONICS ASIACENTRE PTE. LTD.

2 Jalan Kilang Barat, #07-01, Singapore 159346 TEL: +65-6378-7888

PIONEER ELECTRONICS AUSTRALIA PTY. LTD.

5 Arco Lane, Heatherton, Victoria, 3202, Australia, TEL: +61-3-9586-6300

PIONEER ELECTRONICS (THAILAND) CO., LTD.

17th Fl., KPN Tower, 719 Rama 9 Road, Bangkapi, Huaykwang, Bangkok 10310
TEL: +66-2-717-0777

PIONEER TECHNOLOGY (MALAYSIA) SDN. BHD

16th Floor, Menara Uni. Asia 1008 Jalan Sultan Ismail 50250 Kuala Lumpur
TEL: +60-3-2697-2920

先鋒股份有限公司

台灣台北市內湖區瑞光路 407 號 8 樓 TEL: +886-(0)2-2657-3588

先鋒電子(香港)有限公司

香港九龍長沙灣道 909 號 5 樓 TEL: +852-2848-6488

PIONEER ELECTRONICS DE MEXICO S.A. DE C.V.

Blvd. Manuel Avila Camacho 138 10 piso Col.Lomas de Chapultepec, Mexico, D.F. 11000 TEL: +52-55-9178-4270

PIONEER INDIA ELECTRONICS PRIVATE LTD.

216, Second Floor, Time Tower, M.G. Road, Sector 28, Gurgaon 122001, Haryana, India TEL: +91-124-463-6100

PDJ_001_all

Printed in Malaysia

<DRH1404-B>

