

***Pioneer Dj***

**DDJ-RZX**

**DJ Controller**

**<http://pioneerdj.com/support/>  
<http://rekordbox.com/>**

For FAQs and other support information for this product, visit the above site.

**Operating Instructions (Quick Start Guide)**

## IMPORTANT



The lightning flash with arrowhead symbol, within an equilateral triangle, is intended to alert the user to the presence of uninsulated "dangerous voltage" within the product's enclosure that may be of sufficient magnitude to constitute a risk of electric shock to persons.

### CAUTION

**RISK OF ELECTRIC SHOCK  
DO NOT OPEN**

**CAUTION:**  
TO PREVENT THE RISK OF ELECTRIC SHOCK, DO NOT REMOVE COVER (OR BACK). NO USER-SERVICEABLE PARTS INSIDE. REFER SERVICING TO QUALIFIED SERVICE PERSONNEL.



The exclamation point within an equilateral triangle is intended to alert the user to the presence of important operating and maintenance (servicing) instructions in the literature accompanying the appliance.

D3-4-2-1-1b\_A1\_En

## IMPORTANT



Ce symbole de l'éclair, placé dans un triangle équilatéral, a pour but d'attirer l'attention de l'utilisateur sur la présence, à l'intérieur du coffret de l'appareil, de "tensions dangereuses" non isolées d'une grandeur suffisante pour représenter un risque d'électrocution pour les êtres humains.

### ATTENTION

**DANGER D'ÉLECTROCUTION  
NE PAS OUVRIR**

**ATTENTION :**  
POUR ÉVITER TOUT RISQUE D'ÉLECTROCUTION, NE PAS ENLEVER LE COUVERCLE (NI LE PANNEAU ARRIÈRE). AUCUNE PIÈCE RÉPARABLE PAR L'UTILISATEUR NE SE TROUVE À L'INTÉRIEUR. CONFIER TOUT ENTRETIEN À UN PERSONNEL QUALIFIÉ UNIQUEMENT.



Ce point d'exclamation, placé dans un triangle équilatéral, a pour but d'attirer l'attention de l'utilisateur sur la présence, dans les documents qui accompagnent l'appareil, d'explications importantes du point de vue de l'exploitation ou de l'entretien.

D3-4-2-1-1b\_A1\_Fr

# IMPORTANT SAFETY INSTRUCTIONS

- 1) Read these instructions.
- 2) Keep these instructions.
- 3) Heed all warnings.
- 4) Follow all instructions.
- 5) Do not use this apparatus near water.
- 6) Clean only with dry cloth.
- 7) Do not block any ventilation openings. Install in accordance with the manufacturer's instructions. Do not install near any heat sources such as radiators, heat registers, stoves, or other apparatus (including amplifiers) that produce heat. Do not defeat the safety purpose of the polarized or grounding-type plug. A polarized plug has two blades with one wider than the other. A grounding type plug has two blades and a third grounding prong. The wide blade or the third prong are provided for your safety. If the provided plug does not fit into your outlet, consult an electrician for replacement of the obsolete outlet. Protect the power cord from being walked on or pinched particularly at plugs, convenience receptacles, and the point where they exit from the apparatus.
- 8) Only use attachments/accessories specified by the manufacturer.
- 9) Use only with the cart, stand, tripod, bracket, or table specified by the manufacturer, or sold with the apparatus. When a cart is used, use caution when moving the cart/apparatus combination to avoid injury from tip-over.
- 10) Unplug this apparatus during lightning storms or when unused for long periods of time.
- 11) Refer all servicing to qualified service personnel. Servicing is required when the apparatus has been damaged in any way, such as power-supply cord or plug is damaged, liquid has been spilled or objects have fallen into the apparatus, the apparatus has been exposed to rain or moisture, does not operate normally, or has been dropped.



D3-7-13-69\_En

## VENTILATION CAUTION

When installing this unit, make sure to leave space around the unit for ventilation to improve heat radiation (at least 5 cm at top, 5 cm at rear, and 5 cm at each side).

D3-4-2-1-7d\*\_A1\_En

### CAUTION

The  switch on this unit will not completely shut off all power from the AC outlet. Since the power cord serves as the main disconnect device for the unit, you will need to unplug it from the AC outlet to shut down all power. Therefore, make sure the unit has been installed so that the power cord can be easily unplugged from the AC outlet in case of an accident. To avoid fire hazard, the power cord should also be unplugged from the AC outlet when left unused for a long period of time (for example, when on vacation).

D3-4-2-2-2a\*\_A1\_En

## PRÉCAUTION DE VENTILATION

Lors de l'installation de l'appareil, veillez à laisser un espace suffisant autour de ses parois de manière à améliorer la dissipation de chaleur (au moins 5 cm sur le dessus, 5 cm à l'arrière et 5 cm de chaque côté).

D3-4-2-1-7d\*\_A1\_Fr

### ATTENTION

L'interrupteur  de cet appareil ne coupe pas complètement celui-ci de sa prise secteur. Comme le cordon d'alimentation fait office de dispositif de déconnexion du secteur, il devra être débranché au niveau de la prise secteur pour que l'appareil soit complètement hors tension. Par conséquent, veillez à installer l'appareil de telle manière que son cordon d'alimentation puisse être facilement débranché de la prise secteur en cas d'accident. Pour éviter tout risque d'incendie, le cordon d'alimentation sera débranché au niveau de la prise secteur si vous prévoyez une période prolongée de non utilisation (par exemple avant un départ en vacances).

D3-4-2-2-2a\*\_A1\_Fr

## Operating Environment

Operating environment temperature and humidity: +5 °C to +35 °C (+41 °F to +95 °F); less than 85 %RH (cooling vents not blocked)

Do not install this unit in a poorly ventilated area, or in locations exposed to high humidity or direct sunlight (or strong artificial light).

D3-4-2-1-7c\*\_A2\_En

## Milieu de fonctionnement

Température et humidité du milieu de fonctionnement : De +5 °C à +35 °C (de +41 °F à +95 °F) ; Humidité relative inférieure à 85 % (orifices de ventilation non obstrués)

N'installez pas l'appareil dans un endroit mal ventilé ou un lieu soumis à une forte humidité ou en plein soleil (ou à une forte lumière artificielle).

D3-4-2-1-7c\*\_A1\_Fr

## WARNING

This equipment is not waterproof. To prevent a fire or shock hazard, do not place any container filled with liquid near this equipment (such as a vase or flower pot) or expose it to dripping, splashing, rain or moisture.

D3-4-2-1-3\_A1\_En

## AVERTISSEMENT

Cet appareil n'est pas étanche. Pour éviter les risques d'incendie et de décharge électrique, ne placez près de lui un récipient rempli d'eau, tel qu'un vase ou un pot de fleurs, et ne l'exposez pas à des gouttes d'eau, des éclaboussures, de la pluie ou de l'humidité.

D3-4-2-1-3\_A1\_Fr

## WARNING

This product equipped with a three-wire grounding (earthed) plug - a plug that has a third (grounding) pin. This plug only fits a grounding-type power outlet. If you are unable to insert the plug into an outlet, contact a licensed electrician to replace the outlet with a properly grounded one. Do not defeat the safety purpose of the grounding plug.

D3-4-2-1-6\_A1\_En

## AVERTISSEMENT

Cet appareil est muni d'une fiche de mise à la terre (masse) à trois fils. Comme la fiche présente une troisième broche (de terre), elle ne peut se brancher que sur une prise de courant, prévue pour une mise à la terre. Si vous n'arrivez pas à insérer la fiche dans la prise de courant, contactez un électricien qualifié pour faire remplacer la prise par une qui soit mise à la terre. N'annulez pas la fonction de sécurité que procure cette fiche de mise à la terre.

D3-4-2-1-6\_A1\_Fr

## WARNING

To prevent a fire hazard, do not place any naked flame sources (such as a lighted candle) on the equipment.

D3-4-2-1-7a\*\_A1\_En

## AVERTISSEMENT

Pour éviter les risques d'incendie, ne placez aucune flamme nue (telle qu'une bougie allumée) sur l'appareil.

D3-4-2-1-7a\*\_A1\_Fr

Perchlorate Material – special handling may apply. See [www.dtsc.ca.gov/hazardouswaste/perchlorate](http://www.dtsc.ca.gov/hazardouswaste/perchlorate). (Applicable to California, U.S.A.)

K059\_A1\_En

**NOTE:**

This equipment has been tested and found to comply with the limits for a Class B digital device, pursuant to Part 15 of the FCC Rules. These limits are designed to provide reasonable protection against harmful interference in a residential installation. This equipment generates, uses, and can radiate radio frequency energy and, if not installed and used in accordance with the instructions, may cause harmful interference to radio communications. However, there is no guarantee that interference will not occur in a particular installation. If this equipment does cause harmful interference to radio or television reception, which can be determined by turning the equipment off and on, the user is encouraged to try to correct the interference by one or more of the following measures:

- Reorient or relocate the receiving antenna.
- Increase the separation between the equipment and receiver.
- Connect the equipment into an outlet on a circuit different from that to which the receiver is connected.
- Consult the dealer or an experienced radio/TV technician for help.

D8-10-1-2\_A1\_En

**IMPORTANT NOTICE**

THE MODEL NUMBER AND SERIAL NUMBER OF THIS EQUIPMENT ARE ON THE REAR OR BOTTOM. RECORD THESE NUMBERS ON PAGE 19 FOR FUTURE REFERENCE.

D36-AP9-3\*\_A1\_En

**Information to User**

Alterations or modifications carried out without appropriate authorization may invalidate the user's right to operate the equipment.

D8-10-2\_A1\_En

**WARNING:** This product contains chemicals known to the State of California and other governmental entities to cause cancer and birth defects or other reproductive harm.

***Wash hands after handling.***

D36-P5\_C1\_En

**POWER-CORD CAUTION**

Handle the power cord by the plug. Do not pull out the plug by tugging the cord and never touch the power cord when your hands are wet as this could cause a short circuit or electric shock. Do not place the unit, a piece of furniture, etc., on the power cord, or pinch the cord. Never make a knot in the cord or tie it with other cords. The power cords should be routed such that they are not likely to be stepped on. A damaged power cord can cause a fire or give you an electrical shock. Check the power cord once in a while. When you find it damaged, ask your nearest service center or your dealer for a replacement.

S002\*\_A1\_En

**WARNING**

Store small parts out of the reach of children and infants. If accidentally swallowed, contact a doctor immediately.

D41-6-4\_A1\_En

**The Safety of Your Ears is in Your Hands**

Get the most out of your equipment by playing it at a safe level – a level that lets the sound come through clearly without annoying blaring or distortion and, most importantly, without affecting your sensitive hearing. Sound can be deceiving. Over time, your hearing “comfort level” adapts to higher volumes of sound, so what sounds “normal” can actually be loud and harmful to your hearing. Guard against this by setting your equipment at a safe level BEFORE your hearing adapts.

**ESTABLISH A SAFE LEVEL:**

- Set your volume control at a low setting.
- Slowly increase the sound until you can hear it comfortably and clearly, without distortion.
- Once you have established a comfortable sound level, set the dial and leave it there.

**BE SURE TO OBSERVE THE FOLLOWING GUIDELINES:**

- Do not turn up the volume so high that you can't hear what's around you.
- Use caution or temporarily discontinue use in potentially hazardous situations.
- Do not use headphones while operating a motorized vehicle; the use of headphones may create a traffic hazard and is illegal in many areas.

S001a\_A1\_En

**FEDERAL COMMUNICATIONS COMMISSION DECLARATION OF CONFORMITY**

This device complies with part 15 of the FCC Rules. Operation is subject to the following two conditions: (1) This device may not cause harmful interference, and (2) this device must accept any interference received, including interference that may cause undesired operation.

Product Name: DJ CONTROLLER

Model Number: DDJ-RZX

Responsible Party Name: PIONEER ELECTRONICS (USA) INC.  
SERVICE SUPPORT DIVISION

Address: 1925 E. DOMINGUEZ ST. LONG BEACH, CA 90810-1003, U.S.A.

Phone: 1-800-421-1404

URL: <http://www.pioneerelectronics.com>

D8-10-4\*\_C1\_En

# Before start

## How to read this manual

- Thank you for buying this Pioneer DJ product.  
This guide provides a brief description of the procedures up until connecting the unit to your computer and outputting audio. For the detailed procedures, refer to the operating instructions.  
Be sure to read both this leaflet and the operating instructions! Both documents include important information that you must understand before using this product.  
After you have finished reading the instructions, put them away in a safe place for future reference.
- In this manual, names of menus displayed on the product and on the computer screen, as well as names of buttons and terminals, etc., are indicated within brackets. (E.g.: **[File]**, **[CUE]** button, and **[PHONES]** output terminals)
- Please note that the screens and specifications of the software described in this manual as well as the external appearance and specifications of the hardware are currently under development and may differ from the final specifications.
- Please note that depending on the operating system version, web browser settings, etc., operation may differ from the procedures described in this manual.

## Features

This unit is an all-in-one DJ controller designed specifically for rekordbox dj. It's interfaces incorporating various controls such as "DISPLAY", "BIGJOG", "PERFORMANCE PADS" and 4-channel mixer are positioned with room to spare to allow for more individualistic DJ performances using rekordbox dj.

Also, the unit provides "SOUND COLOR FX" and "OSC SAMPLER" functions so that original arrangements can be added to the music being played back.

Furthermore, numerous input and output terminals support a variety of DJ styles. Featuring aluminum material for the top panel, the design makes the unit look high quality, which is appropriate in a variety of scenes such as nightclubs, home parties, etc.

## What's in the box

- Power cord
- USB cable<sup>[1]</sup>
- Warranty<sup>[2]</sup>
- Operating Instructions (Quick Start Guide) (This document)
- Software license notice
- rekordbox dj license key card
- rekordbox dvs license key card
- rekordbox video license key card

[1] Only one USB cable is included with this unit.

To connect two units, use a cable conforming to USB 2.0 standards.

[2] The corresponding information is provided on the back cover of the "Operating Instructions (Quick Start Guide)".

## Cautions

The license key cannot be reissued. Be careful not to lose it.

## Viewing the manuals

### Viewing this unit's Operating Instructions

**1 Launch a web browser on the computer and access the Pioneer DJ site below.**

<http://www.pioneerdj.com/>

**2 Click [Support].**

**3 Click [FIND TUTORIAL & MANUALS].**

**4 Click [DDJ-RZX] in the [CONTROLLER] category.**

**5 Click the required language from the Operating Instructions list.**

Download as necessary.

### Viewing the Operating Instructions of rekordbox

**1 Launch a web browser on the computer and access the rekordbox.com site below.**

<http://rekordbox.com/>

**2 Click [Support].**

**3 Click [Manual].**

**4 Click the required language of the manual.**

## About rekordbox

- rekordbox  
rekordbox is a composite software that enables track management and DJ performances.
- rekordbox dj  
The DJ performance function of rekordbox is called rekordbox dj. Enter the license key shown on the rekordbox dj license key card included with this product to use rekordbox dj.
- rekordbox dvs  
The DVS function, which is a function that can be added to rekordbox dj to perform deck operations using control signals played with CDJ or a turntable, is called rekordbox dvs. Entering the license key shown on the license key card included with this product allows this function to be added to rekordbox dj.
- rekordbox video  
This is a video function that called rekordbox video that can be added to rekordbox dj, and provides playback of video and image files, and performance. Entering the license key shown on the license key card included with this product allows rekordbox dj to be added to this function.

### Minimum operating environment

Supported operating systems	CPU and required memory
Mac OS X: 10.11/10.10/10.9 (latest update)	Intel® processor Core™ i5 2.5 GHz or better 8 GB or more of RAM
Windows: Windows 10, Windows 8.1, Windows 8.1 Pro (latest service pack), Windows 7 Home Premium, Professional, Ultimate (latest service pack)	Intel® processor Core™ i5 2.5 GHz or better 8 GB or more of RAM
Others	
USB port	A USB 2.0 port is required to connect the computer with this unit.
Display resolution	Resolution of 1280 x 768 or greater
Internet connection	An Internet connection is required for registering the rekordbox user account and downloading the software.

- rekordbox is compatible with 64-bit operating systems (Windows/Mac) only.
- For information on the latest system requirements, compatibility, and supported operating systems of rekordbox, see [System Requirements] on the rekordbox.com site below.  
<http://rekordbox.com/>
- Operation is not guaranteed on all computers, even if all the required operating environment conditions indicated here are fulfilled.
- Depending on the computer's power-saving settings, etc., the CPU and hard disk may not provide sufficient processing capabilities. For notebook computers in particular, make sure the computer is in the proper conditions to provide constant high performance (for example by keeping the AC power connected) when using rekordbox.
- Use of the Internet requires a separate contract with a provider offering Internet services and payment of provider fees.
- Use the latest version/service pack of the operating system.

## Installing the application

### Installing rekordbox

#### 1 Access rekordbox.com.

<https://rekordbox.com/en/store/>

- The page content is subject to change without notice.

#### 2 Check the Get Started guide and then click [Free to Download].



#### 3 Carefully read the Software End User License Agreement and select the [Agree] check box if you agree.

When you select the check box, [Download] becomes clickable.

#### 4 Click [Download].

Downloading of rekordbox starts.

#### 5 Double-click the downloaded file to unzip it.

#### 6 Double-click the unzipped file to launch the installer.

#### 7 Carefully read the Software End User License Agreement, and continue with the installation according to the instructions on the screen if you agree.

- If you do not agree to the contents of the Software End User License Agreement, cancel the installation.

#### 8 When the installation completion screen appears, follow the instructions on the screen to close the installer.

The installation is now complete.

- To use rekordbox dj, rekordbox dvs, and rekordbox video, activation (license authentication) is required. For details, see the rekordbox Operating Instructions.  
<https://rekordbox.com/en/support/manual.php>

# Names of Parts

For details on the functions of the various buttons and controls, see *Part names and functions* in the Operating Instructions.

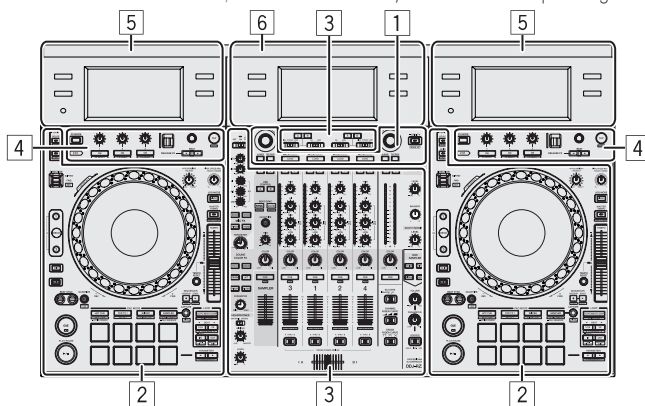

1 Browser section

2 Deck section

3 Mixer section

4 Effect section

5 Display section (deck)

6 Display section (mixer)

## Browser section

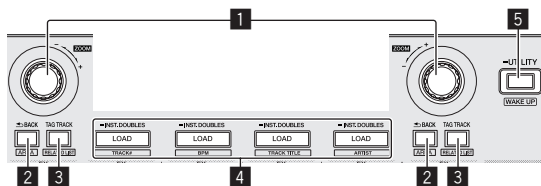

1 Rotary selector

2 BACK button

3 TAG TRACK button

4 LOAD button

5 UTILITY button

## Display section (deck)

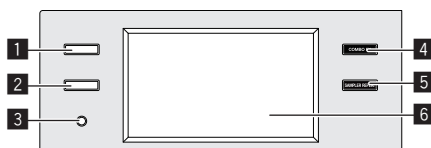

1 VIEW (PAD INFO / DECK VIDEO) button

2 TRACK INFO button

3 TIME MODE button

4 COMBO FX button

5 SAMPLER REPEAT button

6 Touch display (deck)

## Display section (mixer)

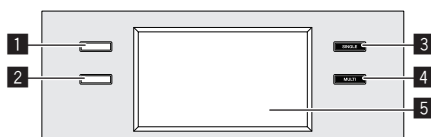

1 VIEW (WAVEFORM / MASTER VIDEO) button

2 2DECK/4DECK button

3 SOUND COLOR FX SINGLE MODE button

4 SOUND COLOR FX MULTI MODE button

5 Touch display (mixer)

## Deck section

This section is used to control the four decks. The buttons and controls for operating decks 1 and 3 are located on the left side of the controller, those for operating decks 2 and 4 are located on the right side of the controller.

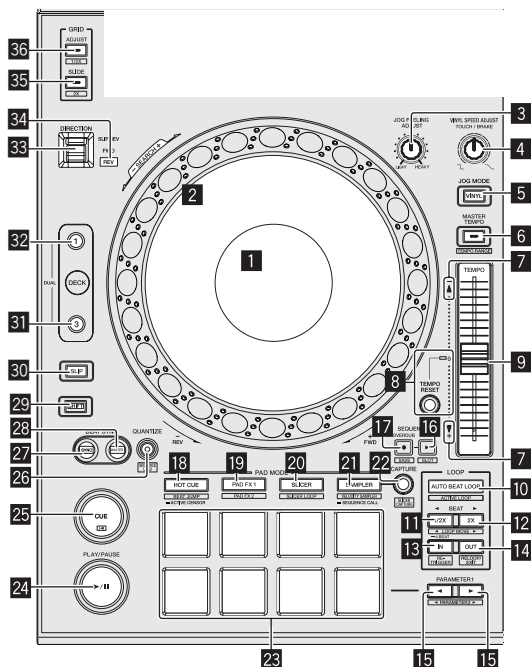

- |   |                                  |
|---|----------------------------------|
| <b>1</b> Jog dial display section                     | <b>24</b> PLAY/PAUSE ►/   button |
| <b>2</b> Jog dial                                     | <b>25</b> CUE button             |
| <b>3</b> JOG FEELING ADJUST control                   | <b>26</b> QUANTIZE button        |
| <b>4</b> VINYL SPEED ADJUST control                   | <b>27</b> SYNC button            |
| <b>5</b> JOG MODE button                              | <b>28</b> MASTER button          |
| <b>6</b> MASTER TEMPO button                          | <b>29</b> SHIFT button           |
| <b>7</b> Takeover indicator                           | <b>30</b> SLIP button            |
| <b>8</b> TEMPO RESET button and TEMPO RESET indicator | <b>31</b> DECK 3 button          |
| <b>9</b> TEMPO slider                                 | <b>32</b> DECK 1 button          |
| <b>10</b> AUTO BEAT LOOP button                       | <b>33</b> DIRECION FWD REV lever |
| <b>11</b> LOOP 1/2X button                            | <b>34</b> REV indicator          |
| <b>12</b> LOOP 2X button                              | <b>35</b> GRID SLIDE button      |
| <b>13</b> LOOP IN button                              | <b>36</b> GRID ADJUST button     |
| <b>14</b> LOOP OUT button                             |                                  |
| <b>15</b> PARAMETER◀ button, PARAMETER▶ button        |                                  |
| <b>16</b> SEQUENCER START button                      |                                  |
| <b>17</b> SEQUENCER OVERDUB button                    |                                  |
| <b>18</b> HOT CUE mode button                         |                                  |
| <b>19</b> PAD FX1 mode button                         |                                  |
| <b>20</b> SLICER mode button                          |                                  |
| <b>21</b> SAMPLER mode button                         |                                  |
| <b>22</b> CAPTURE button                              |                                  |
| <b>23</b> Performance pads                            |                                  |



# Mixer section

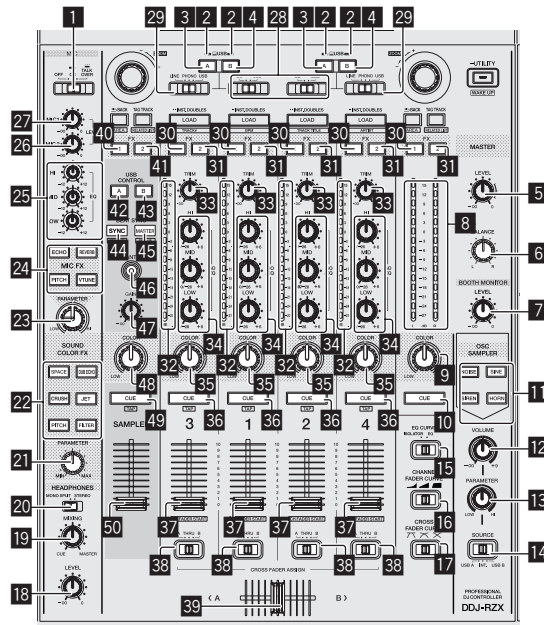

- |   |   |
|---|---|
| <b>1</b> OFF, ON, TALK OVER selector switch             | <b>26</b> MIC2 control                      |
| <b>2</b> USB connection indicator                       | <b>27</b> MIC1 control                      |
| <b>3</b> USB (A) button                                 | <b>28</b> CD, USB selector switch           |
| <b>4</b> USB (B) button                                 | <b>29</b> LINE, PHONO, USB selector switch  |
| <b>5</b> MASTER LEVEL control                           | <b>30</b> FX 1 assign button                |
| <b>6</b> MASTER BALANCE control                         | <b>31</b> FX 2 assign button                |
| <b>7</b> BOOTH MONITOR control                          | <b>32</b> Channel Level Indicator           |
| <b>8</b> Master level indicator                         | <b>33</b> TRIM control                      |
| <b>9</b> MASTER OUT COLOR control                       | <b>34</b> ISO/EQ (HI, MID, LOW) controls    |
| <b>10</b> MASTER CUE button                             | <b>35</b> COLOR control                     |
| <b>11</b> OSC SAMPLER SELECT button                     | <b>36</b> Headphones CUE button             |
| <b>12</b> OSC SAMPLER VOLUME control                    | <b>37</b> Channel fader                     |
| <b>13</b> OSC SAMPLER PARAMETER control                 | <b>38</b> Crossfader assign selector switch |
| <b>14</b> OSC SAMPLER SOURCE selector switch            | <b>39</b> Crossfader                        |
| <b>15</b> EQ CURVE selector switch                      | <b>40</b> SAMPLER CH FX 1 assign button     |
| <b>16</b> CHANNEL FADER CURVE selector switch           | <b>41</b> SAMPLER CH FX 2 assign button     |
| <b>17</b> CROSS FADER CURVE selector switch             | <b>42</b> SAMPLER CH USB (A) button         |
| <b>18</b> HEADPHONES LEVEL control                      | <b>43</b> SAMPLER CH USB (B) button         |
| <b>19</b> HEADPHONES MIXING control                     | <b>44</b> SAMPLER SYNC button               |
| <b>20</b> HEADPHONE MONO SPLIT / STEREO selector switch | <b>45</b> SAMPLER MASTER button             |
| <b>21</b> SOUND COLOR FX PARAMETER control              | <b>46</b> SAMPLER QUANTIZE button           |
| <b>22</b> SOUND COLOR FX SELECT buttons                 | <b>47</b> SAMPLER GAIN control              |
| <b>23</b> MIC FX PARAMETER control                      | <b>48</b> SAMPLER COLOR control             |
| <b>24</b> MIC FX SELECT button                          | <b>49</b> SAMPLER CUE button                |
| <b>25</b> MIC EQ (HI, MID, LOW) controls                | <b>50</b> SAMPLER VOLUME fader              |

## Effect section

This section is used to control the two effect units (FX1 and FX2). Controls and buttons used to operate the FX1 unit are located on the left side of the controller, those used to operate the FX2 unit are located on the right side of the controller. The channels to which the effect is to be applied are set using the effect assign buttons on the mixer section.

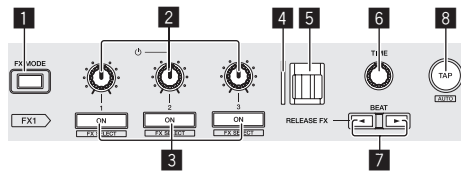

- |                                    |                                       |
|------------------------------------|---------------------------------------|
| <b>1</b> FX MODE button            | <b>5</b> RELEASE FX lever             |
| <b>2</b> Effect parameter controls | <b>6</b> TIME control                 |
| <b>3</b> Effect parameter buttons  | <b>7</b> BEAT ◀ button, BEAT ▶ button |
| <b>4</b> RELEASE FX indicator      | <b>8</b> TAP button                   |

## Rear panel

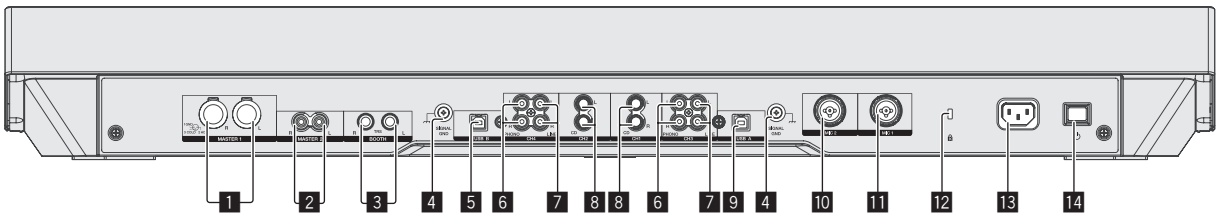

- |                              |                                    |
|------------------------------|------------------------------------|
| <b>1</b> MASTER 1 terminals  | <b>8</b> CD terminals              |
| <b>2</b> MASTER 2 terminals  | <b>9</b> USB-A terminal            |
| <b>3</b> BOOTH terminals     | <b>10</b> MIC2 terminal            |
| <b>4</b> SIGNAL GND terminal | <b>11</b> MIC1 terminal            |
| <b>5</b> USB-B terminal      | <b>12</b> Kensington security slot |
| <b>6</b> PHONO terminals     | <b>13</b> AC IN terminal           |
| <b>7</b> LINE terminals      | <b>14</b> ⏻ switch                 |

## Front panel

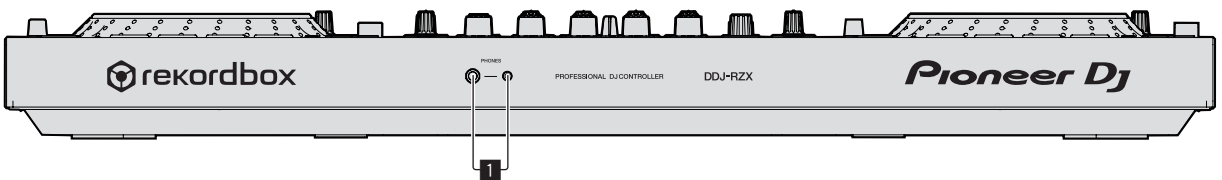

- 1** PHONES jacks

# Operation

- Connect the power cord after all the connections between devices have been completed.  
Be sure to turn off the power and unplug the power cord from the power outlet whenever making or changing connections.  
Refer to the operating instructions for the component to be connected.
- Be sure to use the included power cord.
- Be sure to use the USB cable included with this product or the one that conforms to USB 2.0.

## Example of connections

### Connecting input terminals

#### Rear panel

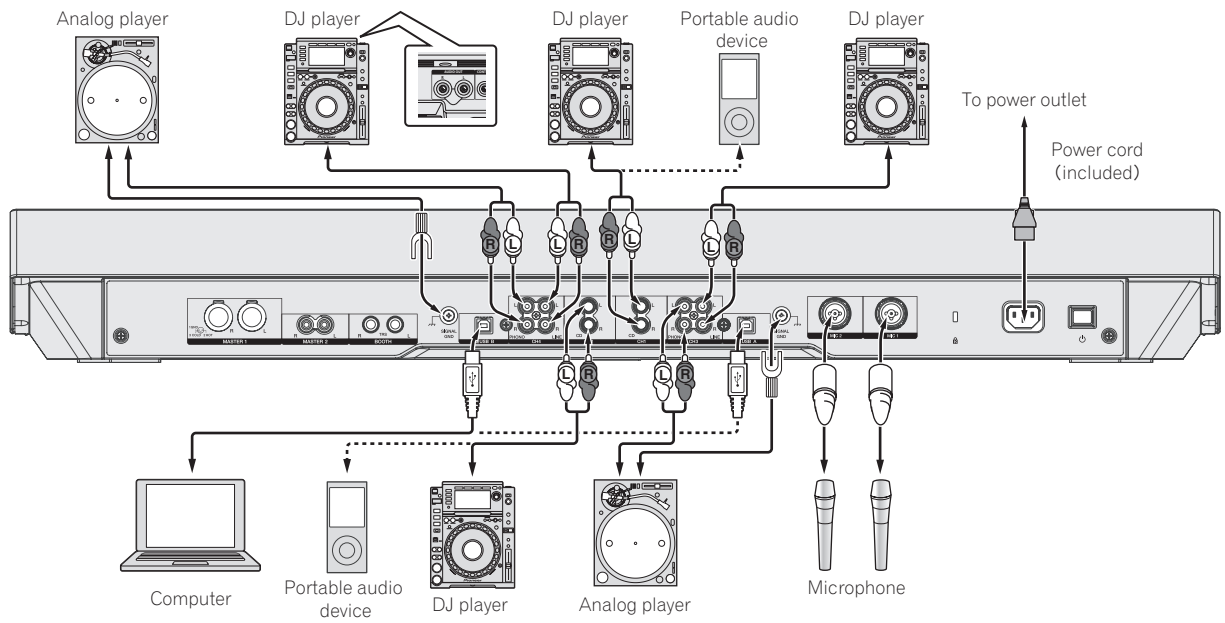

### Connecting output terminals

#### Rear panel

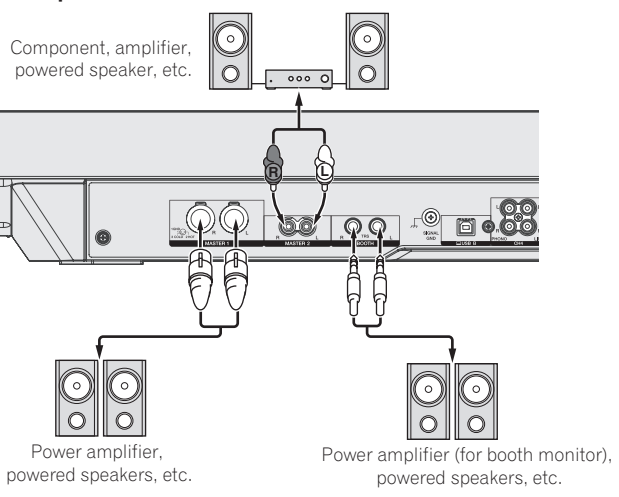

#### Front panel



# Connections

For information on using this product with rekordbox dj, refer to this product's operating instructions published on the Pioneer DJ site.

## 1 Connect headphones to one of the [PHONES] terminals.

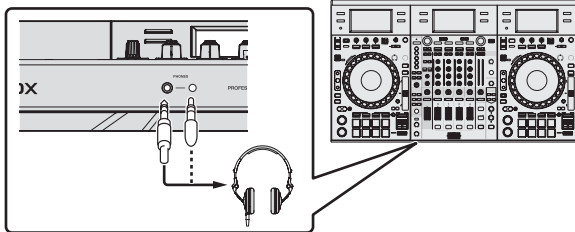

## 2 Connect powered speakers, a power amplifier, components, etc., to the [MASTER 1] or [MASTER 2] terminals.

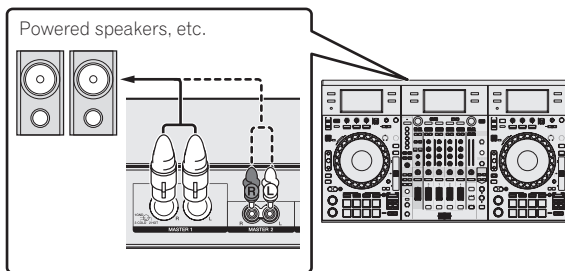

- To output the sound from the [BOOTH] terminals, connect speakers or other devices to the [BOOTH] terminals.

## 3 Connect this unit to your computer via a USB cable.

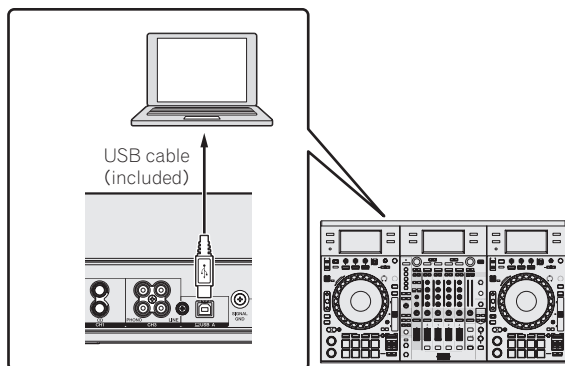

## 4 Turn on the computer's power.

## 5 Connect the power cord.

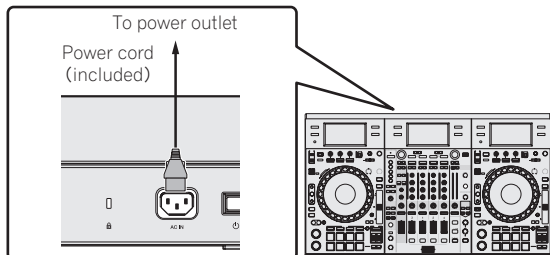

## 6 Press the [⏻] switch on this unit's rear panel to turn this unit's power on.

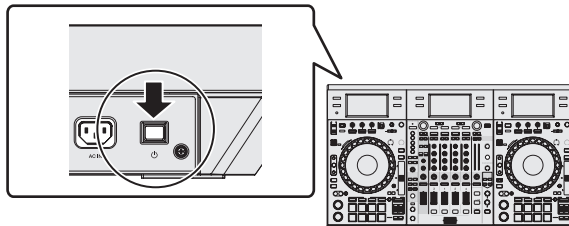

Turn on the power of this unit.

- For Windows users  
The message [Installing device driver software] may appear when this unit is first connected to the computer or when it is connected to a different USB port on the computer. Wait a while until the message [Your devices are ready for use] appears.

## 7 Turn on the power of the devices connected to the output terminals (powered speakers, power amplifier, components, etc.).

- When a microphone, DJ player or other external device is connected to input terminals, the power of that device also turns on.

# Starting the system

## Launching rekordbox

Account registration for KUVVO and activation work for rekordbox dj, rekordbox dvs, and rekordbox video are required at first startup. For details on each work procedure, access the rekordbox product site below and see the rekordbox Operating Instructions in [Support].  
<https://rekordbox.com/en/support/manual.php>

### For Windows 7

Click the [All Programs] > [Pioneer] > [rekordbox X.X.X] > [rekordbox] icon from the Windows [Start] menu.

### For Windows 10/8.1

From [Apps view], click the [rekordbox] icon.

### For Mac OS X

Open the [Applications] folder in Finder, then double-click the [rekordbox] icon.

## Adding music files to [Collection]

"Collection" is music files that are managed by rekordbox.

The music files on the computer can be used with rekordbox if they are analyzed and then registered as rekordbox music collection files.



a Tree View

b Track list

### 1 Click [Collection] in the tree view.

The [Collection] music files are displayed in the track list.

### 2 Open Finder or Windows explorer, then drag and drop music files or folders including music files to the track list.

The music files are added to the [Collection] and the tag information of the music files is read and then displayed.

This manual consists mainly of explanations of functions of this unit as hardware. For detailed instructions on operating rekordbox dj, see the rekordbox software's manual.

## Loading tracks and playing them

The following describes the procedure for loading tracks onto deck 1 as an example.

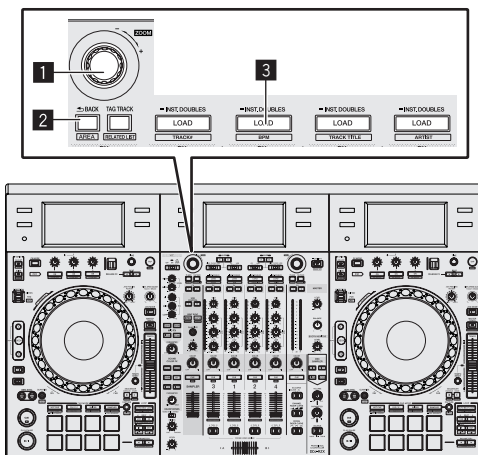

### 1 Rotary selector

### 2 BACK button

### 3 LOAD button

1 Select the [Collection] or a playlist or other item and then press the unit's rotary selector to move to the track list.

2 Turn the rotary selector and select the track.

3 Press the [LOAD] button to load the selected track onto the deck.

## Playing tracks and outputting the sound

The following describes the procedure for outputting the channel 1 sound as an example.

- Set the volume of the devices (power amplifier, powered speakers, etc.) connected to the [MASTER 1] and [MASTER 2] terminals to an appropriate level. Note that loud sound will be output if the volume is set too high.

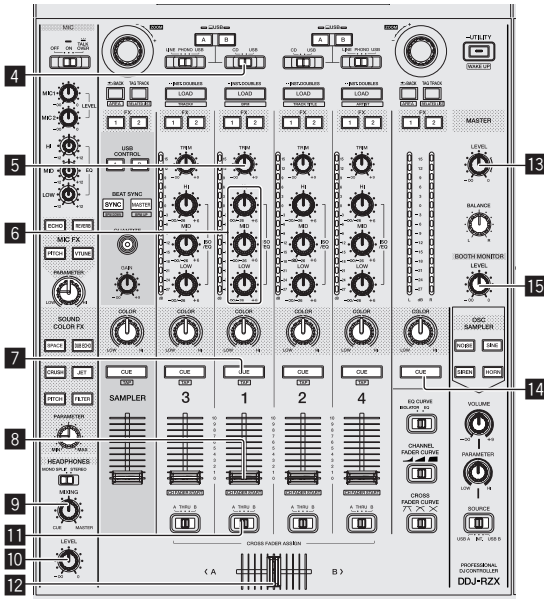

4 CD, USB selector switch

5 TRIM control

6 ISO/EQ (HI, MID, LOW) controls

7 Headphones CUE button

8 Channel fader

9 HEADPHONES MIXING control

10 HEADPHONES LEVEL control

11 Crossfader assign selector switch

12 Crossfader

13 MASTER LEVEL control

14 MASTER CUE button

15 BOOTH MONITOR control

1 Set the positions of the controls, etc., as shown below.

Names of controls, etc.	Position
MASTER LEVEL control	Turned fully counterclockwise
CD, USB selector switch	[USB] position
TRIM control	Turned fully counterclockwise
ISO/EQ (HI, MID, LOW) controls	Center
Channel fader	Moved forward
Crossfader assign selector switch	[THRU] position

2 Press the [PLAY/PAUSE ►/II] button to play the track.

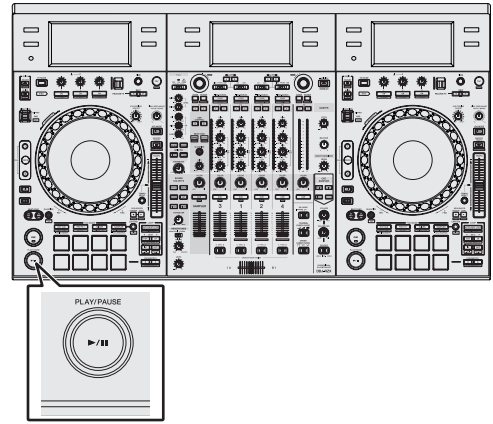

3 Turn the [TRIM] control.

Adjust the [TRIM] control so that the channel level indicator's orange indicator lights at peak level.

4 Move the channel fader away from you.

5 Turn the [MASTER LEVEL] control to adjust the audio level of the speakers.

Adjust the sound level output from the [MASTER 1] and [MASTER 2] terminals to an appropriate level.

## Monitoring sound with headphones

Set the positions of the controls, etc., as shown below.

Names of controls, etc.	Position
HEADPHONES MIXING control	Center
HEADPHONES LEVEL control	Turned fully counterclockwise

1 Press the headphones [CUE] button for the channel 1.

2 Turn the [HEADPHONES LEVEL] control.

Adjust the sound level output from the headphones to an appropriate level.

### Note

This unit and rekordbox dj include many functions to allow for more individualistic DJ performances. For details on each function, see the rekordbox software's manual.

- The rekordbox software's manual can be downloaded from rekordbox.com. For details, see *Viewing the Operating Instructions of rekordbox* (p.5).

## Quitting the system

1 Quit rekordbox.

2 Press the [⏻] switch on this unit's rear panel to set this unit's power to standby.

3 Disconnect the USB cable from your computer.

---

---

# Additional information

---

---

---

## Changing the settings

---

- For detailed instructions on changing this unit's settings, see *Changing the settings* in the Operating Instructions.

---

## Troubleshooting

---

- If you think that there is something wrong with this unit, check the items in the "Troubleshooting" section of this unit's operating instructions and access the Pioneer DJ site and check [FAQ] for the [DDJ-RZX].  
<http://www.pioneerdj.com/>  
Sometimes the problem may lie in another component. Inspect the other components and electrical appliances being used. If the problem cannot be rectified, ask your nearest Pioneer authorized service center or your dealer to carry out repair work.
- This unit may not operate properly due to static electricity or other external influences. In this case, proper operation may be restored by turning the power off, waiting 1 minute, then turning the power back on.

---

## Cleaning the touch display

---

Do not use organic solvents, acids or alkalis for cleaning the surface of the touch display. Wipe with a dry soft cloth or a cloth immersed in neutral detergent and squeezed properly.

---

## About trademarks and registered trademarks

---

- Pioneer DJ is a trademark of the PIONEER CORPORATION and is used under license. rekordbox and KUVU are trademarks or registered trademarks of the Pioneer DJ Corporation.
- Windows is a registered trademark of Microsoft Corporation in the United States and other countries.
- Mac, Mac OS, and Finder are trademarks of Apple Inc., registered in the U.S. and other countries.
- Intel and Intel Core are trademarks of Intel Corporation in the U.S. and/or other countries.

The names of companies and products mentioned herein are trademarks or registered trademarks of their respective owners.

---

## Cautions on copyrights

---

rekordbox restricts playback and duplication of copyright-protected music contents.

- When coded data, etc., for protecting the copyright is embedded in the music contents, it may not be possible to operate the program normally.
- When rekordbox detects that coded data, etc., for protecting the copyright is embedded in the music contents, processing (playback, reading, etc.) may stop.

Recordings you have made are for your personal enjoyment and according to copyright laws may not be used without the consent of the copyright holder.

- Music recorded from CDs, etc., is protected by the copyright laws of individual countries and by international treaties. It is the full responsibility of the person who has recorded the music to ensure that it is used legally.
- When handling music downloaded from the Internet, etc., it is the full responsibility of the person who has downloaded the music to ensure that it is used in accordance with the contract concluded with the download site.

## Specifications

Power requirements .....	AC 110 V to 240 V, 50 Hz/60 Hz
Power consumption .....	48 W
Power consumption (standby) .....	0.4 W
Main unit weight .....	15.9 kg (35.1 lb)
Max. dimensions .....	945 mm (W) × 119.7 mm (H) × 547 mm (D) (37.2 in. (W) × 4.7 in. (H) × 21.5 in. (D))
Tolerable operating temperature .....	+5 °C to +35 °C (+41 °F to +95 °F)
Tolerable operating humidity .....	5 % to 85 % (no condensation)

### Audio Section

Sampling rate .....	44.1 kHz/48 kHz/96 kHz
MASTER D/A converter .....	32 bits
Other A/D and D/A converters .....	24 bits
Frequency characteristic	

**USB, CD/LINE, MIC1, MIC2** .....

S/N ratio (rated output, A-WEIGHTED)

**USB** .....

**CD/LINE** .....

**PHONO** .....

**MIC1** .....

**MIC2** .....

Total harmonic distortion (20 Hz — 20 kHzBW)

**USB** .....

**CD/LINE** .....

Standard input level / Input impedance

**CD/LINE** .....

**PHONO** .....

**MIC1** .....

**MIC2** .....

Standard output level / Load impedance / Output impedance

**MASTER 1** .....

**MASTER 2** .....

**BOOTH** .....

**PHONES** .....

Rated output level / Load impedance

**MASTER 1** .....

**MASTER 2** .....

**BOOTH** .....

Crosstalk

**CD/LINE** .....

Channel equalizer characteristic

**HI** .....

**MID** .....

**LOW** .....

Microphone equalizer characteristic

**HI** .....

**MID** .....

**LOW** .....

### Input / Output terminals

**CD/LINE** Input terminals

RCA pin jacks .....

**PHONO** input terminals

RCA pin jacks .....

**MIC** terminal

XLR connector & 1/4" TRS jack .....

**MASTER 1** output terminal

XLR connector .....

**MASTER 2** output terminal

RCA pin jacks .....

**BOOTH** output terminal

1/4" TRS jack .....

**PHONES** output terminal

1/4" stereo jack .....

3.5 mm stereo mini jack .....

**USB** terminals

B type .....

— Be sure to use the **[MASTER 1]** terminals only for a balanced output. Connection with an unbalanced input (such as RCA) using an XLR to RCA converter cable (or converter adapter), etc., may lower the sound quality and/or result in noise.

For connection with an unbalanced input (such as RCA), use the **[MASTER 2]** terminals.







# Pioneer Dj

Pioneer DJ Americas, Inc.  
**LIMITED WARRANTY**  
WARRANTY VALID ONLY IN THE U.S.A. AND CANADA

## WARRANTY

Pioneer DJ Americas, Inc. (PDJA) warrants that products distributed by PDJA in the U.S.A. and Canada that fail to function properly under normal use due to a manufacturing defect when installed and operated according to the owner's manual enclosed with the unit will be repaired or replaced with a unit of comparable value, at the option of PDJA, without charge to you for parts or actual repair work. Parts supplied under this warranty may be new or rebuilt at the option of PDJA.

**THIS LIMITED WARRANTY APPLIES TO THE ORIGINAL OR ANY SUBSEQUENT OWNER OF THIS PIONEER DJ PRODUCT DURING THE WARRANTY PERIOD PROVIDED THE PRODUCT WAS PURCHASED FROM AN AUTHORIZED PIONEER DJ DISTRIBUTOR/DEALER IN THE U.S.A. OR CANADA. YOU WILL BE REQUIRED TO PROVIDE A SALES RECEIPT OR OTHER VALID PROOF OF PURCHASE SHOWING THE DATE OF ORIGINAL PURCHASE OR, IF RENTED, YOUR RENTAL CONTRACT SHOWING THE PLACE AND DATE OF FIRST RENTAL. IN THE EVENT SERVICE IS REQUIRED, THE PRODUCT MUST BE DELIVERED WITHIN THE WARRANTY PERIOD, TRANSPORTATION PREPAID, ONLY FROM WITHIN THE U.S.A. AS EXPLAINED IN THIS DOCUMENT. YOU WILL BE RESPONSIBLE FOR REMOVAL AND INSTALLATION OF THE PRODUCT. PDJA WILL PAY TO RETURN THE REPAIRED OR REPLACEMENT PRODUCT TO YOU WITHIN THE U.S.A.**

## PRODUCT WARRANTY PERIOD

### DJ Audio and Video

Parts Labor

1 Year 1 Year

The warranty period for retail customers who rent the product commences upon the date product is first put into use (a) during the rental period or (b) retail sale, whichever occurs first.

## WHAT IS NOT COVERED

**IF THIS PRODUCT WAS PURCHASED FROM AN UNAUTHORIZED DISTRIBUTOR, THERE ARE NO WARRANTIES, EXPRESS OR IMPLIED, INCLUDING THE IMPLIED WARRANTY OF MERCHANTABILITY AND THE IMPLIED WARRANTY OF FITNESS FOR A PARTICULAR PURPOSE AND THIS PRODUCT IS SOLD STRICTLY "AS IS" AND "WITH ALL FAULTS".**

**PIONEER DJ SHALL NOT BE LIABLE FOR ANY CONSEQUENTIAL AND/OR INCIDENTAL DAMAGES.**

**THIS WARRANTY DOES NOT APPLY IF THE PRODUCT HAS BEEN SUBJECTED TO POWER IN EXCESS OF ITS PUBLISHED POWER RATING.**

**THIS WARRANTY DOES NOT COVER THE CABINET OR ANY APPEARANCE ITEM, USER ATTACHED ANTENNA, ANY DAMAGE TO RECORDS OR RECORDING TAPES OR DISCS, ANY DAMAGE TO THE PRODUCT RESULTING FROM ALTERATIONS, MODIFICATIONS NOT AUTHORIZED IN WRITING BY PIONEER DJ, ACCIDENT, MISUSE OR ABUSE, DAMAGE DUE TO LIGHTNING OR TO POWER SURGES, SUBSEQUENT DAMAGE FROM LEAKING, DAMAGE FROM INOPERATIVE BATTERIES, OR THE USE OF BATTERIES NOT CONFORMING TO THOSE SPECIFIED IN THE OWNER'S MANUAL.**

**THIS WARRANTY DOES NOT COVER THE COST OF PARTS OR LABOR WHICH WOULD BE OTHERWISE PROVIDED WITHOUT CHARGE UNDER THIS WARRANTY OBTAINED FROM ANY SOURCE OTHER THAN A PIONEER DJ AUTHORIZED SERVICE COMPANY OR OTHER DESIGNATED LOCATION. THIS WARRANTY DOES NOT COVER DEFECTS OR DAMAGE CAUSED BY THE USE OF UNAUTHORIZED PARTS OR LABOR OR FROM IMPROPER MAINTENANCE.**

**ALTERED, DEFACED, OR REMOVED SERIAL NUMBERS VOID THIS ENTIRE WARRANTY**

## NO OTHER WARRANTIES

**PIONEER DJ LIMITS ITS OBLIGATIONS UNDER ANY IMPLIED WARRANTIES INCLUDING, BUT NOT LIMITED TO, THE IMPLIED WARRANTIES OF MERCHANTABILITY AND FITNESS FOR A PARTICULAR PURPOSE, TO A PERIOD NOT TO EXCEED THE WARRANTY PERIOD. NO WARRANTIES SHALL APPLY AFTER THE WARRANTY PERIOD. SOME STATES DO NOT ALLOW LIMITATIONS ON HOW LONG AN IMPLIED WARRANTY LASTS AND SOME STATES DO NOT ALLOW THE EXCLUSIONS OR LIMITATIONS OF INCIDENTAL OR CONSEQUENTIAL DAMAGES, SO THE ABOVE LIMITATIONS OR EXCLUSIONS MAY NOT APPLY TO YOU. THIS WARRANTY GIVES YOU SPECIFIC LEGAL RIGHTS AND YOU MAY HAVE OTHER RIGHTS WHICH MAY VARY FROM STATE TO STATE.**

## TO OBTAIN SERVICE

PDJA has appointed a number of Authorized Service Companies throughout the U.S.A. and Canada should your product require service. To receive warranty service you need to present your sales receipt or, if rented, your rental contract showing place and date of original owner's transaction. If shipping the unit you will need to package it carefully and send it, transportation prepaid by a traceable, insured method, to an Authorized Service Company. Package the product using adequate padding material to prevent damage in transit. The original container is ideal for this purpose. Include your name, address and telephone number where you can be reached during business hours.

On all complaints and concerns in the U.S.A. and Canada call Customer Support at 1-800-872-4159.

For hook-up and operation of your unit or to locate an  
Authorized Service Company, please call or write:  
CUSTOMER SUPPORT  
PIONEER ELECTRONICS (USA) INC.  
P.O. BOX 1720  
LONG BEACH, CALIFORNIA 90801  
1-800-872-4159  
<http://www.pioneerelectronics.com>

## DISPUTE RESOLUTION

Following our response to any initial request to Customer Support, should a dispute arise between you and Pioneer DJ, Pioneer DJ makes available its Complaint Resolution Program to resolve the dispute. The Complaint Resolution Program is available to you without charge. You are required to use the Complaint Resolution Program before you exercise any rights under, or seek any remedies, created by Title I of the Magnuson-Moss Warranty-Federal Trade Commission Improvement Act, 15 U.S.C. 2301 *et seq.*

To use the Complaint Resolution Program call 1-800-872-4159 and explain to the customer service representative the problem you are experiencing, steps you have taken to have the product repaired during the warranty period and the name of the authorized Distributor/Dealer from whom the Pioneer DJ product was purchased. After the complaint has been explained to the representative, a resolution number will be issued. Within 40 days of receiving your complaint, Pioneer DJ will investigate the dispute and will either: (1) respond to your complaint in writing informing you what action Pioneer DJ will take, and in what time period, to resolve the dispute; or (2) respond to your complaint in writing informing you why it will not take any action.

## RECORD THE PLACE AND DATE OF PURCHASE FOR FUTURE REFERENCE

Model No. \_\_\_\_\_ Serial No. \_\_\_\_\_ Purchase Date \_\_\_\_\_

Purchased From \_\_\_\_\_

KEEP THIS INFORMATION AND YOUR SALES RECEIPT IN A SAFE PLACE

UCP0116

To register your product, find the nearest authorized service location, to purchase replacement parts, operating instructions, or accessories, please go to one of following URLs :

Pour enregistrer votre produit, trouver le service après-vente agréé le plus proche et pour acheter des pièces de rechange, des modes d'emploi ou des accessoires, reportez-vous aux URL suivantes :

**In the USA/Aux Etats-Unis or In Canada/Aux Canada**  
<http://www.pioneerelectronics.com>

S018\_C1\_EnFr\_PSV

© 2016 Pioneer DJ Corporation.  
All rights reserved.

**Pioneer DJ Corporation**

6F, Yokohama i-Mark Place, 4-4-5 Minatomirai, Nishi-ku, Yokohama, Kanagawa 220-0012 JAPAN

**Pioneer DJ 株式会社**

〒220-0012 神奈川県横浜市西区みなとみらい4丁目4番5号 横浜アイマークプレイス6階

**Корпорация Пайонир Диджей**

6F, Йокогама i-Mark Place, 4-4-5 Минатомирай, Ниси-ку, Йокогама, Канагава 220-0012 ЯПОНИЯ

**Pioneer DJ Europe Limited**

Anteros Building, Odyssey Business Park, West End Road, South Ruislip, Middlesex, HA4 6QQ, U.K. TEL: +44-203-7617-220

**Pioneer DJ Americas, Inc.**

2050 W. 190th Street, Suite 109, Torrance, CA 90504, U.S.A. TEL: +1 (424) 488-0480

**PIONEER ELECTRONICS ASIACENTRE PTE. LTD.**

2 Jalan Kilang Barat, #07-01, Singapore 159346 TEL: +65-6378-7888

**PIONEER ELECTRONICS AUSTRALIA PTY. LTD.**

5 Arco Lane, Heatherton, Victoria, 3202, Australia, TEL: +61-3-9586-6300

**PIONEER ELECTRONICS (THAILAND) CO., LTD.**

17th Fl., KPN Tower, 719 Rama 9 Road, Bangkapi, Huaykwang, Bangkok 10310  
TEL: +66-2-717-0777

**PIONEER TECHNOLOGY (MALAYSIA) SDN. BHD**

16th Floor, Menara Uni. Asia 1008 Jalan Sultan Ismail 50250 Kuala Lumpur  
TEL: +60-3-2697-2920

**先鋒股份有限公司**

台灣台北市內湖區瑞光路 407 號 8 樓 TEL: +886-(0)2-2657-3588

**先鋒電子(香港)有限公司**

香港九龍長沙灣道 909 號 5 樓 TEL: +852-2848-6488

**PIONEER ELECTRONICS DE MEXICO S.A. DE C.V.**

Blvd. Manuel Avila Camacho 138 10 piso Col.Lomas de Chapultepec, Mexico, D.F. 11000 TEL: +52-55-9178-4270

**PIONEER INDIA ELECTRONICS PRIVATE LTD.**

216, Second Floor, Time Tower, M.G. Road, Sector 28, Gurgaon 122001, Haryana, India TEL: +91-124-463-6100

PDJ\_001\_all

Printed in

<DRH1344-A>

