



# AD4D

## Dual Channel Receiver

AD4D Axient Digital Dual Channel Receiver User Guide  
Version: 4 (2019-E)

# Table of Contents

<b>AD4DDual Channel Receiver</b>	<b>4</b>	Frequency Diversity	24
<b>IMPORTANT SAFETY INSTRUCTIONS</b>	<b>4</b>	Antenna Bias	25
<b>Australia Warning for Wireless</b>	<b>5</b>	RF Cascade Ports	25
<b>AD4D Axient Digital Two-Channel Wireless Receiver</b>	<b>5</b>	Firmware	25
Features	5	<b>Audio Settings</b>	<b>26</b>
<b>Included Components</b>	<b>6</b>	Adjusting Channel Gain and Audio Output	26
<b>Mounting Instructions</b>	<b>6</b>	Tone Generator	27
<b>Hardware</b>	<b>7</b>	Headphone Monitoring	27
Receiver Front Panel	7	System Gain	28
Receiver Back Panel	8	<b>Networking</b>	<b>28</b>
<b>Menus and Configuration</b>	<b>10</b>	Networking Receivers	28
Accessing the Device Configuration Menu or Channel Menus	10	Network Browser	29
Home Screen	11	Network Troubleshooting	30
Screen Icons	11	<b>Operation</b>	<b>30</b>
Device Configuration Menu and Parameters	12	Assigning a Device ID	30
AD4D Device Configuration Parameters	13	Assigning a Channel Name	30
Channel Menu Parameters	17	Locking and Unlocking the Controls	31
<b>Radio Frequency (RF) Settings</b>	<b>19</b>	Display Screen Options	31
Setting the RF Tuning Band	19	Saving Receiver Settings as User Presets	31
IR Sync	19	Programming Transmitters Using IR Presets	31
Setting the Frequency Manually	20	Encryption	32
Channel Scan and Group Scan	20	Restoring the Receiver to Factory Settings	32
Requesting a New Frequency from a Spectrum Manager 2 1		Cooling Fan	32
Transmission Modes	22	<b>Troubleshooting</b>	<b>33</b>
Assigning Transmitters to Transmitter Slots	22	Power	33
Interference Management	23	Gain	33
Channel Quality Meter	24	Cables	33
		Interface Locks	33
		Encryption Mismatch	33
		Firmware Mismatch	34
		Radio Frequency (RF)	34

---

<b>Specifications</b>	<b>35</b>	<b>Receiver Frequency Bands</b>	<b>40</b>
Tables and Diagrams	40	<b>Certifications</b>	<b>41</b>

---

# AD4D

## Dual Channel Receiver

---

### IMPORTANT SAFETY INSTRUCTIONS

1. READ these instructions.
2. KEEP these instructions.
3. HEED all warnings.
4. FOLLOW all instructions.
5. DO NOT use this apparatus near water.
6. CLEAN ONLY with dry cloth.
7. DO NOT block any ventilation openings. Allow sufficient distances for adequate ventilation and install in accordance with the manufacturer's instructions.
8. DO NOT install near any heat sources such as open flames, radiators, heat registers, stoves, or other apparatus (including amplifiers) that produce heat. Do not place any open flame sources on the product.
9. DO NOT defeat the safety purpose of the polarized or grounding type plug. A polarized plug has two blades with one wider than the other. A grounding type plug has two blades and a third grounding prong. The wider blade or the third prong are provided for your safety. If the provided plug does not fit into your outlet, consult an electrician for replacement of the obsolete outlet.
10. PROTECT the power cord from being walked on or pinched, particularly at plugs, convenience receptacles, and the point where they exit from the apparatus.
11. ONLY USE attachments/accessories specified by the manufacturer.
12. USE only with a cart, stand, tripod, bracket, or table specified by the manufacturer, or sold with the apparatus. When a cart is used, use caution when moving the cart/apparatus combination to avoid injury from tip-over.



13. UNPLUG this apparatus during lightning storms or when unused for long periods of time.
14. REFER all servicing to qualified service personnel. Servicing is required when the apparatus has been damaged in any way, such as power supply cord or plug is damaged, liquid has been spilled or objects have fallen into the apparatus, the apparatus has been exposed to rain or moisture, does not operate normally, or has been dropped.
15. DO NOT expose the apparatus to dripping and splashing. DO NOT put objects filled with liquids, such as vases, on the apparatus.
16. The MAINS plug or an appliance coupler shall remain readily operable.
17. The airborne noise of the Apparatus does not exceed 70dB (A).
18. Apparatus with CLASS I construction shall be connected to a MAINS socket outlet with a protective earthing connection.
19. To reduce the risk of fire or electric shock, do not expose this apparatus to rain or moisture.
20. Do not attempt to modify this product. Doing so could result in personal injury and/or product failure.
21. Operate this product within its specified operating temperature range.

**WARNING:** Voltages in this equipment are hazardous to life. No user-serviceable parts inside. Refer all servicing to qualified service personnel. The safety certifications do not apply when the operating voltage is changed from the factory setting.

---

## Australia Warning for Wireless

This device operates under an ACMA class licence and must comply with all the conditions of that licence including operating frequencies. Before 31 December 2014, this device will comply if it is operated in the 520-820 MHz frequency band.

**WARNING:** After 31 December 2014, in order to comply, this device must not be operated in the 694-820 MHz band.

---

## AD4D Axient Digital Two-Channel Wireless Receiver

The AD4D Axient Digital Two-Channel Wireless Receiver sets a new standard in transparent digital audio and maximum spectral efficiency. Groundbreaking performance features include wide tuning, low latency, and High Density (HD) mode, ensuring solid performance in the most challenging RF environments. Networked control, AES3 and Dante output, and signal routing options bring a new level of management and flexibility to your entire workflow. Compatible with all Axient Digital transmitters.

## Features

### Audio

- 60 dB of gain adjustment offers compatibility with a wide range of input sources
- Dante™ networking for quick and easy channel management
- Dante Browse feature for headphone monitoring of all Dante channels, including third party components
- AES 256 encryption to protect audio channels
- Automatic limiter function protects against signal clipping, allowing for higher gain settings and preventing unexpected signal peaks
- Front panel connection for headphones with adjustable volume

### I/O

- Two transformer-balanced XLR outputs
- AES3 Digital output
- Two transformer-balanced 1/4" outputs
- Two Dante-enabled Ethernet ports, two network control Ethernet ports with PoE
  - Split-Redundant mode: Two ports of Ethernet, two ports of Dante
  - Switched mode: Two ports of Ethernet, four ports of Dante
- Locking AC power connection
- AC power cascade to additional components
- Optional DC module available to support redundant power

### RF

- True digital diversity reception per channel
- Up to 210 MHz of tuning range

- Frequency diversity with selection (bodypack) or combining (handheld)
- Channel Quality meter displays signal-to-noise ratio of RF signal
- Antenna cascade for one additional receiver
- Preprogrammed group and channel maps with options for custom groups
- Search for open frequencies via receiver using group and channel scan
- Perform full bandwidth scan for frequency coordination via Wireless Workbench
- Register up to eight transmitters to one receiver channel
- High Density transmission mode enables up to 47 active transmitters in one 6 MHz TV channel (up to 63 in one 8 MHz TV channel)

## Network Control

- Wireless Workbench™ control software
- ShurePlus™ Channels mobile device control
- Console integration
- Control systems support

## Included Components

The following components are included with the receiver:

<b>Hardware Kit</b>	90XN1371
<b>Bulkhead Adapter, BNC</b>	95A8994
<b>1/2 Wave Wideband Antenna (2)</b>	Varies by region
<b>BNC-BNC Coaxial RF Cable for Bulkhead Mounting (short)</b>	95B9023
<b>BNC-BNC Coaxial RF Cable for Bulkhead Mounting (long)</b>	95C9023
<b>Coaxial RF Cascade Cable</b>	95N2035
<b>AC Power Cable, VLock</b>	Varies by region
<b>AC Power Jumper Cable</b>	Varies by region
<b>Ethernet Cable 3 ft.</b>	95A33402
<b>Ethernet Jumper Cable</b>	95B33402

## Mounting Instructions

This component is designed to fit into an audio rack.

Warning: To prevent injury this apparatus must be securely attached to the rack.

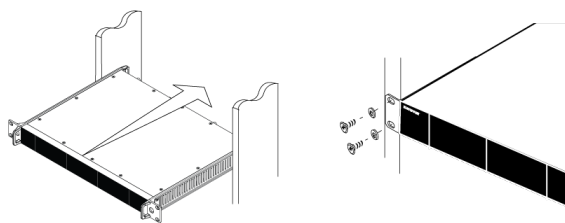

## Hardware

### Receiver Front Panel



#### ① Headphone Volume Knob

Controls headphone volume for the selected channel. Clip indicator warns of signal overload or limiter engagement. Press knob to access Dante options and headphone settings.

#### ② Monitor Jack

¼" (6.3 mm) output jack.

#### ③ Infrared (IR) Sync LED

The LED will turn red when the transmitter and receiver are correctly aligned for IR sync.

#### ④ Infrared (IR) Sync Window

Align with IR window on transmitter to sync.

#### ⑤ Ambient Light Sensor

Automatically detects external lighting conditions.

#### ⑥ Channel Select Button

Press to select channel.

#### ⑦ Sync Button

Press to sync when transmitter and receiver are aligned. The IR Sync LED changes to red to indicate correct alignment.

#### ⑧ Antenna Status LEDs

Indicates status for both antennas:

- Blue = Normal RF signal between the receiver and transmitter
- Red = Interference detected
- Off = No RF connection between the receiver and transmitter

**Note:** The receiver will not output audio unless one blue LED is illuminated.

## 9 RF Signal Strength LEDs

Indicate the RF signal strength from the transmitter:

- Orange = Normal (-90 to -70 dBm in 5 dBm increments)
- Red = Overload (greater than -20 dBm)

## 10 Audio LEDs

Red, yellow, and green LEDs indicate average and peak audio levels.

The LED will turn red when the limiter is engaged.

## 11 Display

Displays information for the selected channel.

## 12 Function Buttons

Press to access editing and configuration options. The buttons are named F1, F2, F3, F4 (from top to bottom) and illuminate to when editing options are available.

## 13 ENTER Button

Press to save changes.

## 14 EXIT Button

Press to cancel changes and return to main menus.

## 15 Control Wheel

- Push to enter a menu
- Push to select a channel or menu item
- Turn to scroll through menu items or to edit a parameter value

## 16 Power Switch

Powers the unit on or off.

# Receiver Back Panel

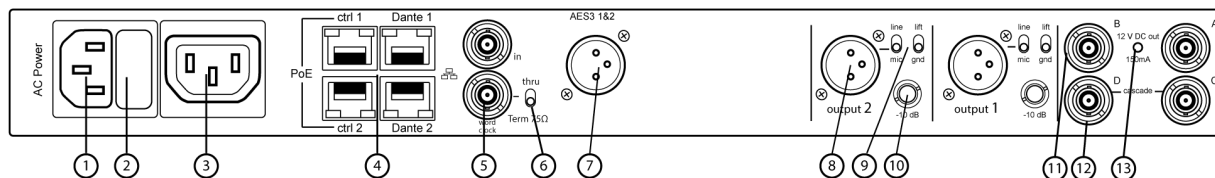



## ① AC Power Input

IEC locking connector, 100 - 240 V AC.

## ② AC Power Protection Fuse

Protects the AC power cascade from overloads.

## ③ AC Power Cascade (locking)

Use IEC extension cables to loop power through multiple devices.

## ④ Ethernet Ports

Four Ethernet ports carry the following signals:

- *ctrl 1*: Network control
- *ctrl 2*: Network control
- *Dante Primary*: Dante digital audio
- *Dante Secondary*: Dante digital audio

Network Status (green) LEDs:

- Off: no network link
- On: network link active
- Flashing: network link active, rate corresponds to traffic volume

Network Speed (amber) LEDs:

- Off = 10/100 Mbps
- On = 1 Gbps

## ⑤ Word Clock Input and Thru Ports

- Input: Connect to an external word clock to resolve the AES3 digital output
- Thru: Passes word clock signal to additional components

## ⑥ Word Clock Termination Switch

- Set to *Thru* when passing signal to additional components
- Set to *Term 75Ω* when Thru connection is not used

## ⑦ AES3 Digital Audio Output

Connector for AES3 Digital Audio.

## ⑧ Balanced XLR Audio Output (one per channel)

- Transformer Balanced
- Connect to a mic or line level input.

## ⑨ Mic/Line Switch and Ground Lift Switch (one per channel)

- Mic/Line: Applies a 30 dB pad in *mic* position.
- Ground Lift: Lifts the ground from pin 1 of the XLR connector and the sleeve of the ¼" Audio Output

## ⑩ ¼" Audio Output (one per channel)

Transformer Balanced

### ⑪ Coaxial inputs from Antenna A and Antenna B

RF Connection for Antenna A and Antenna B.

### ⑫ RF Cascade Connectors C and D

Passes the RF signal from Antenna A and Antenna B to one additional receiver.

### ⑬ Antenna Bias Indicator LED

- Green: Antenna bias enabled
- Red: Antenna fault
- Off: Antenna bias disabled

## Menus and Configuration

The receiver uses a two-tier menu structure to support multiple channels in a single rack space:

- Device Configuration Menu: Items in this menu affect the overall performance of the receiver and apply to all channels globally
- Channel Configuration Menus: Each channel has its own menu allowing for independent channel configuration

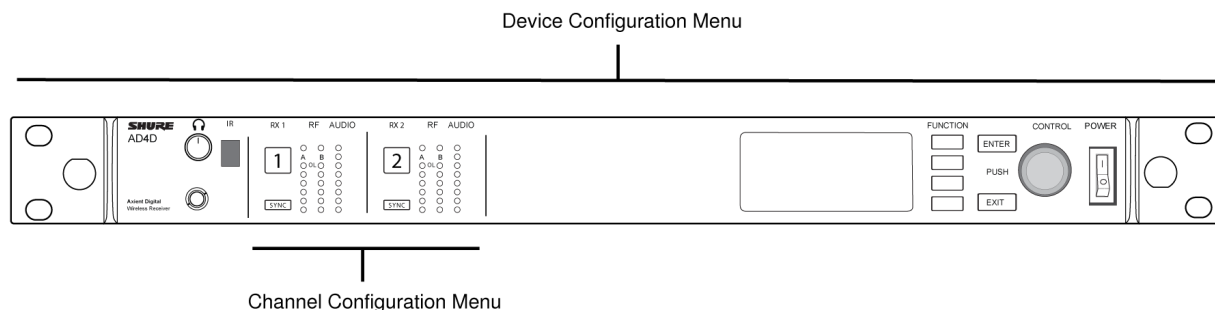

## Accessing the Device Configuration Menu or Channel Menus

From the home screen, use the following methods to access the *Device Configuration* menu or to enter one of the channel menus.

- To enter the *Device Configuration* menu, press the control wheel
- To enter a *Channel* menu, select the channel number, and then press the control wheel to access the channel menu

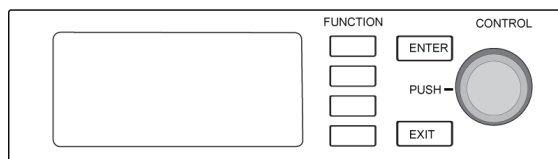

## Home Screen





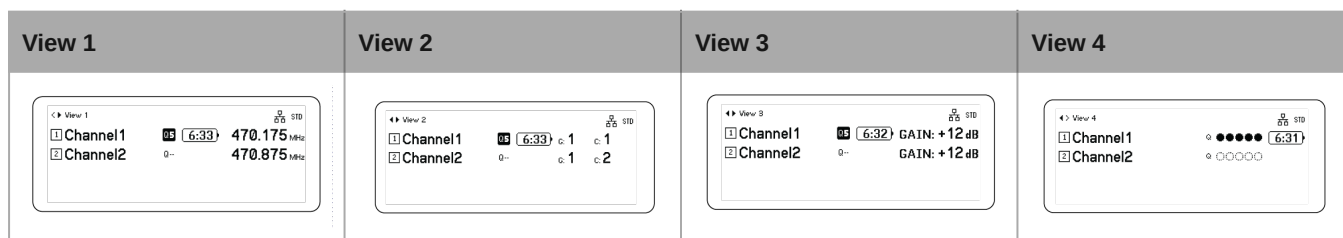

From the home screen you can view the status of all four channels.







You can rotate the control wheel to choose different views of the information shown on the home screen, including channel name, group and channel, quality meter, gain, and frequency.



## Screen Icons

The following screen icons indicate receiver modes or settings:

<b>STD</b>	Standard Transmission Mode
<b>HD</b>	High Density Transmission Mode
<b>G:</b>	Frequency Group
<b>C:</b>	Channel
<b>TV:</b>	TV band for selected frequency
<b>AES3</b>	AES3 Output Selected
<b>View</b>	Selected Home Screen View
▲	Scroll Up for More Choices
▼	Scroll Down for More Choices
▶	Scroll Right for More Choices
◀	Scroll Left for More Choices
	Network Connection Present for Other Shure Devices or WWB
	Power Switch Locked
	Front Panel Controls Locked
	Indicates that a transmitter is linked to the receiver channel
	Indicates ShowLink control active between the receiver and the linked transmitter
	Indicates the controls of a linked transmitter are locked.

	Indicates that the linked transmitter's RF signal is on
	Indicates an alert or warning
	Combining Frequency Diversity Enabled
	Selection Frequency Diversity Enabled
	Encryption Enabled
	Access Control Enabled

## Device Configuration Menu and Parameters

Use the following menu items and parameter settings to configure the receiver at the device level.

Tip: Use the *ENTER* button to save changes or press *EXIT* to cancel without saving.

### Device Configuration Menu Screen

From the home screen, press the control wheel to access the *Device Configuration* menu.

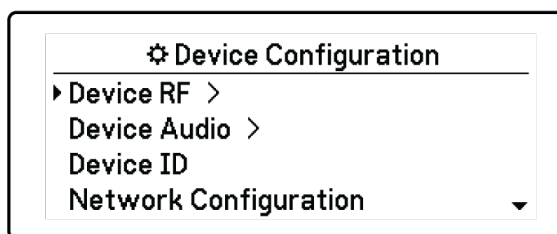

## Device Configuration Menu Map

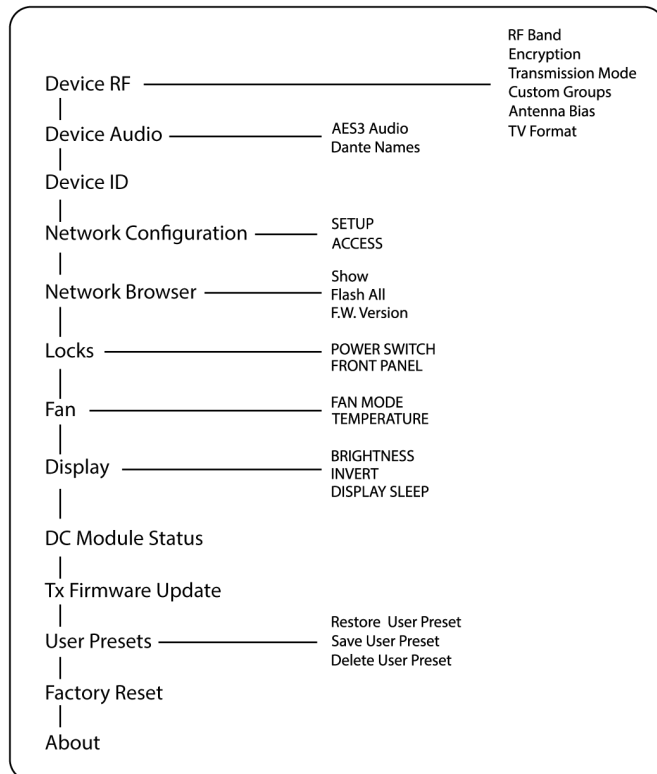

## AD4D Device Configuration Parameters

### *Device RF*

#### **RF Band**

Select the tuning band for the receiver.

#### **Encryption**

Enables encryption of the RF signal.

#### **Transmission Mode**

Select *Standard* or *High Density* transmitter spacing.

#### **Custom Groups**

Configure, edit, or load custom frequency groups.

#### **Antenna Bias**

Enable antenna bias for active RF antennas.

#### **TV Format**

Adjust TV bandwidth to match regional standards.

---

## Device Audio

### **AES3 Audio**

Configure AES3 audio parameters.

### **Dante Names**

View, edit, and copy names for networked Dante components.

## Device ID

### **Device ID**

Use the control wheel to assign or edit an ID.

## Network Configuration

Configure IP, network, and Dante settings.

### **Setup**

Configure Ethernet ports and IP settings.

### **Access**

View the status of Access Control (*Enabled* or *Disabled*). Use Wireless Workbench or other Shure control software to enable or disable Access Control.

## Network Browser

Use the Network Browser utility to view Shure devices on the network.

### **Show**

Display all devices on the network.

### **Flash All**

Flash the front panel LED of all devices on the network to verify connectivity.

### **F.W. Version**

Displays the installed firmware version of the selected network component.

## Locks

### **Power Switch**

- Locked
- Unlocked

## Front Panel

- Locked
- Unlocked

## Fan

### Fan Mode

- *Auto*: The fan will automatically turn on if the receiver temperature rises
- *On*: The fan will run continuously to offer maximum cooling in warm environments

### Temperature

Displays internal receiver temperature.

## Display

### Brightness

Adjust the brightness of the display.

### Invert

Inverts the color of the display.

### Display Sleep

Offers options to turn off display and front panel illumination after 10, 30, or 60 seconds.

Tip:

Press any front panel control to interrupt *Display Sleep*.

## DC Module Status

Displays the operational status of the DC Module (if installed).

## Tx Firmware Update

Align transmitter IR window and select to update transmitter firmware.

## User Presets

Create and manage user presets.

- *Restore User Preset*: Load existing preset
- *Save User Preset*: Save the current settings as a preset
- *Delete User Preset*: Delete a preset

## Factory Reset

Restores all receiver parameters to factory settings.

## About

Provides a detailed list of build specifications and vital statistics for the receiver.

## Channel Menu

Use the following menus and parameters to configure the receiver channels.

Tip: Use the channel selection buttons to navigate between adjacent channels when configuring menu parameters. Use the *ENTER* button to save changes or press *EXIT* to cancel without saving.

## Channel Menu Home Screen

The Channel Menu Home Screen allows you to view the settings for a selected channel and details of transmitters linked to that channel. Select a channel number to access the menu.

You can adjust gain, group, channel, and frequency by using the *EDIT* function button.

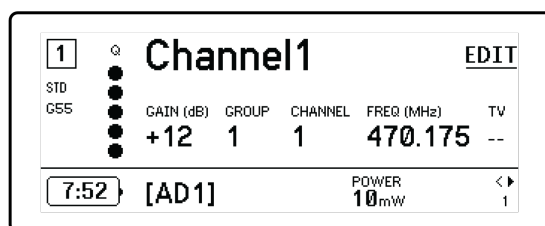

## Channel Menu

Use the Channel Menu to select and edit menu parameters. Press the Control Wheel to access the Channel Menu from the Channel Menu Home Screen.

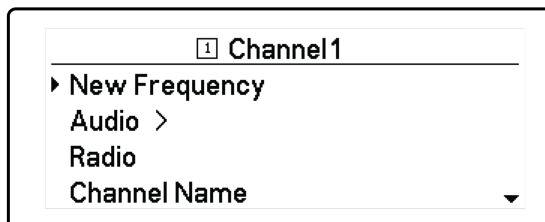



## Channel Menu Map

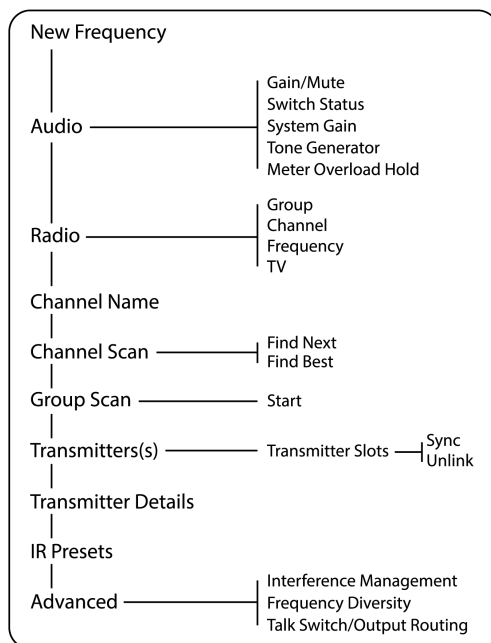

## Channel Menu Parameters

### New Frequency

Press *ENTER* to deploy a new frequency when using a spectrum manager as a frequency server.

*Note: This menu option will not be shown if you don't have a frequency server assigned to the receiver.*

### Audio

#### Gain/Mute

Adjusts the receiver gain.

- *Gain*: Adjust the gain in 1 dB increments
- *Output*: Select *On* or *Mute* for the receiver audio output

#### Switch Status

Displays the switch position of the ground lift and level switches.

#### System Gain

View and calculate all gain stages in the signal chain, including input pads, mic offset, and receiver gain.

#### Tone Generator

Provides a continuous audio signal tone for testing and troubleshooting.

#### Meter Overload Hold

---

Enable Overload Hold to capture signal peaks.

## Radio

### **G: (Group)**

Assign a frequency group.

### **C: (Channel)**

Assign a channel.

### **Frequency**

Manually select a frequency.

### **TV**

Displays the TV band for the selected frequency.

## Channel Name

### **Channel Name**

Use the control wheel to assign or edit the channel name.

## Channel Scan

Finds available channels within the selected group:

- *Find Next*: Selects the nearest available channel
- *Find Best*: Selects the channels with the best RF noise floor

## Group Scan

Scans the selected group to find all available channels.

## Transmitters(s)

### **Transmitter Slots**

Use the control wheel to assign and view transmitter slots.

### **ACTIVATE (ADX transmitters linked to ShowLink access point)**

Choose a transmitter with the control wheel, and then press *ACTIVATE* pass RF and RF mute all other transmitters.

### **FLASH (ADX transmitters linked to ShowLink access point)**

Flashes the display to of a transmitter linked to the receiver.

### **UNLINK**

Removes a transmitter from the selected slot.

**SYNC:**

Assigns a transmitter to the selected slot when *SYNC* is pressed.

## Transmitter Details

Displays build details and vital statistics for the selected transmitter.

## IR Presets

Select and edit transmitter parameters so they will automatically be set during an IR sync.

## Advanced

### Interference Management

Select interference detection setting for the channel.

### Frequency Diversity

Configure frequency diversity for handheld or bodypack transmitters.

### Talk Switch/Output Routing

Set receiver output signal routing options for talk switch control from a transmitter.

---

# Radio Frequency (RF) Settings

## Setting the RF Tuning Band

The receiver offers selectable tuning bands to maximize the use of locally available spectrum.

1. From the *Device Configuration* menu: *Device RF > RF Band*
2. Press the control wheel to enable editing, and then select an RF band.
3. Press *ENTER* to save.

*Note: After setting the RF band, re-sync any transmitters that are linked to the receiver.*



## IR Sync

Use IR Sync to form an audio channel between the transmitter and receiver.

*Note: The receiver band must match the band of the transmitter.*

1. Select a receiver channel.
2. Tune the channel to an available frequency using group scan.
3. Power on the transmitter.
4. Press the SYNC button on the receiver.
5. Align the IR windows until the receiver IR sync LED illuminates red. When complete, *Sync Success!* appears. The transmitter and receiver are now tuned to the same frequency.

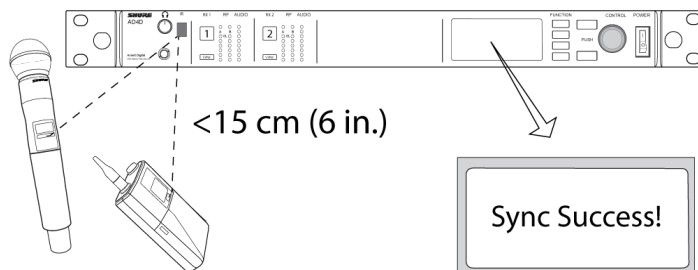

*Note:*

Any change to the encryption status on the receiver such as enabling/ disabling encryption or requesting a new encryption key, requires a sync to send the settings to the transmitter.

## Setting the Frequency Manually

Frequencies can be set manually for each channel if you need to select specific values.

1. Select a channel and navigate to the *Radio* menu.
2. Use the control wheel to select the *FREQ (MHz)* parameter.
3. Press the control wheel to enable editing and rotate to change the value.
4. Press *ENTER* to save changes.

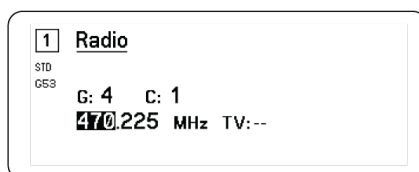

## Channel Scan and Group Scan

The receiver can scan individual channels to find available frequencies or scan an entire group to find the most available frequencies.

**Important!** Before you begin:

**Turn off** all transmitters for the systems you are setting up. (This prevents them from interfering with the frequency scan.)

**Turn on** the following potential sources of interference so they are operating as they would be during the presentation or performance (the scan will detect and avoid any interference they generate).

- Other wireless systems or devices
- Computers

- CD players
- Large LED panels
- Effects processors

## Channel Scan

Channel scan automatically scans a group to find available frequencies.

1. From a selected channel menu: *Channel Scan*
2. To begin, use the control wheel to choose the group you'd like to scan.
3. Choose one of the following options:
  - *Find Next*: Finds the next available frequency within the group
  - *Find Best*: Finds the best available frequency based on RSSI
4. Press *ENTER* to confirm your frequency selection.

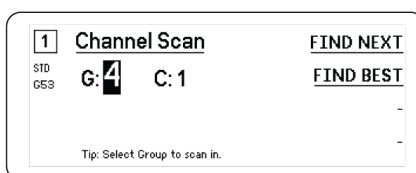

## Group Scan

Group scan automatically finds all available frequencies within a group. Available frequencies can be automatically deployed to receiver channels and other networked components.

1. From a selected channel: *Group Scan*.
2. Press *Start* to scan the group.
3. When the scan is complete, the number of frequencies found are shown on the display.
4. Select *Deploy* to assign frequencies to components on the network.

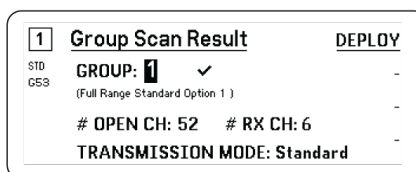

## Requesting a New Frequency from a Spectrum Manager

When you have assigned a Spectrum Manager as a frequency server for the receiver, you can use the *New Frequency* menu option to quickly change to a clear frequency. The *New Frequency* option is only available when you have assigned a Spectrum Manager as a frequency server for the receiver.

**Caution:** After a new frequency has been assigned, the frequency of any linked transmitters must be updated manually or by using IR sync.

1. Navigate to a channel menu, and then select *New Frequency*.
2. Select *ENTER* to get a new frequency from the Spectrum Manager.

# Transmission Modes

The receiver offers two transmission modes to efficiently manage the available spectrum used by the transmitters:

## Standard Mode

Standard mode employs channel spacing that allows for the operation of transmitters at various power levels.

Standard mode is ideal for situations where spectrum is not limited or when you need to operate transmitters at higher power levels to increase range.

## High Density Mode

High Density mode creates additional bandwidth for more channels in crowded RF environments by transmitting at 2 mW RF power and narrowing the modulation bandwidth.

High Density mode is ideal for applications where many channels are needed in a confined area, transmission distances are short, and the number of available frequencies is limited.

Note: Operation mode varies according to region. In Brazil, High Density mode is used.

## Selecting a Transmission Mode

1. From the *Device Configuration* menu: *Device RF > Transmission Mode*
2. Press the control wheel to enable editing. Rotate the wheel to select a mode.
3. Press *ENTER* to save.

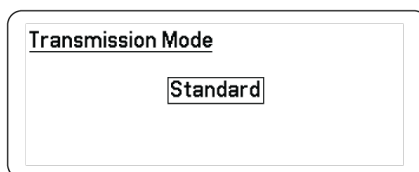

## Assigning Transmitters to Transmitter Slots

Each receiver channel contains eight transmitter slots to control the RF signals passed by the receiver. Transmitters can be assigned to the channel slots or "registered" with the receiver.

For added protection from interference, the receiver will issue a warning or block signals from any transmitters that aren't registered.

To assign a transmitter to a receiver channel:

1. From the *Channel* menu: *Transmitter(s) > Transmitter Slots*
2. Use the control wheel to scroll to an available transmitter slot. If the slot is occupied, syncing will overwrite the existing transmitter.
3. Align the transmitter with the IR sync window and press *SYNC*.

When the sync is complete, the transmitter will be assigned to the slot. The transmitter will remain assigned to the slot until it is unlinked. To remove a transmitter from a slot, use the control wheel to select the slot, and then press *UNLINK*.

Tip: For quick access, the slots can be accessed from the channel menu by selecting the F4 function button.

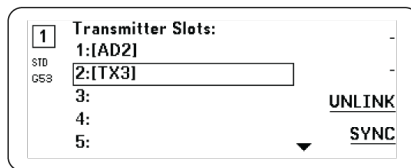

## Interference Management

In the event of signal degradation, Interference Management technology provides options to move to a clean, compatible frequency, either manually or automatically.

Respond to an alert by manually selecting a new frequency, or allow the Spectrum Manager or Wireless Workbench to automatically deploy a backup frequency the instant interference is detected.

Tip: To dismiss a interference alert, select the affected channel, and then select *Dismiss*.

## Configuring Interference Management

Interference Management can be configured for each channel individually.

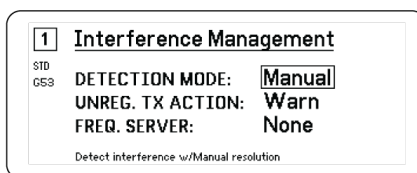

## Setting the Detection Mode

The Mode setting determines how the receiver will switch to a clear frequency in the event of interference

1. Select a channel and navigate to: *Advanced > Interference Management*
2. Choose one of the following modes:
  - *Manual*: Select a frequency manually when interference occurs
  - *Automatic*: Allow the receiver to automatically select a new frequency.

## Unregistered Transmitter Action

The unregistered transmitter option determines how the receiver reacts to the presence of unregistered transmitters, which can be a potential source of interference.

From the Interference Management menu, choose one of the following options:

- *Allow*: The receiver will pass audio from the unregistered transmitter
- *Warn*: The receiver will display a warning when an unregistered transmitter is detected
- *Block*: The receiver treat the unregistered transmitter as interference and will block the audio

## Frequency Server

The frequency server option allows you to assign a networked Spectrum Manager as a server for clear frequencies in the event of interference.

1. From the *Interference Management* menu, select *Freq. Server*
2. Press the control wheel to enable editing, and then select a Spectrum Manager from your network.
3. Press *ENTER* to save.

## Channel Quality Meter

The home screen displays a channel quality meter, providing a visual indicator of the signal-to-noise ratio of the RF signal. When the RF signal is strong with a low level of noise, all five segments of the meter are filled or the number 5 is displayed.

If the noise ratio increases, the fewer segments are displayed or the quality number drops. Low levels of channel quality provide an early warning of potential problems, allowing you to switch to a clear frequency.

Segment	Number
Q ●●●●●	Q5

## Frequency Diversity

Frequency Diversity enables seamless, uninterrupted audio for mission-critical applications. Frequency Diversity works by transmitting the audio on two independent frequencies from an ADX2FD Frequency Diversity handheld transmitter or from two AD/ADX series transmitters.

When operated in Frequency Diversity mode, the receiver uses two frequencies to provide a single channel of audio. If one frequency experiences interference, the audio from the other frequency is used to prevent dropouts or interruption of the audio.

Using Frequency Diversity in conjunction with Interference Detection provides an additional layer of protection for the audio signal.

1. From the channel menu: *Advanced > Frequency Diversity*.
2. Choose one of the following frequency diversity modes:
  - *Combining*: For use with a single ADX2FD handheld transmitter
  - *Selection*: For use with a pair of AD1 or ADX1 series transmitters
3. Press *ENTER* to save.
4. Perform an IR sync between the receiver and the transmitters.

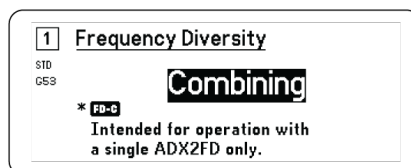



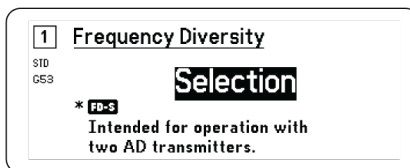

## Antenna Bias

All antenna ports provide a DC bias to power active antennas. Set the DC power to off when using passive (non-powered) antennas.

To turn off the antenna bias:

1. From the Device Configuration menu: *Device RF > Antenna Bias*
2. Press the control wheel to enable editing, and then select *Off*

Tip: The Antenna Bias screen displays the current draw for each individual antenna and the total current draw for all antennas.

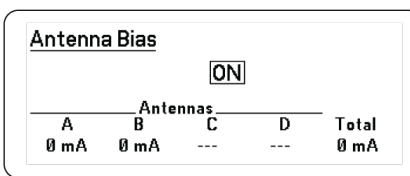

## RF Cascade Ports

The receiver has two RF cascade ports on the rear panel to share the RF signal from the antennas with one additional receiver.

Use a shielded coaxial cable to connect the RF cascade ports from the first receiver to the antenna inputs of the second receiver.

Important: The frequency model (A, B, C) must be the same for both receivers.

## Firmware

Firmware is embedded software in each component that controls functionality. Installing the latest version of firmware updates the receiver to incorporate additional features and enhancements. New versions of the firmware can be uploaded and installed using the Shure Update Utility tool available in Shure Wireless Workbench 6 (WWB6) software. Software is available for download from <http://www.shure.com>.

## Firmware Versioning

When updating receiver firmware, update transmitters to the same firmware version to ensure consistent operation.

The firmware of all devices has the form of MAJOR.MINOR.PATCH (e.g., 1.2.14). At a minimum, all devices on the network (including transmitters), must have the same MAJOR and MINOR firmware version numbers (e.g., 1.2.x).

## Updating the Receiver Firmware

**CAUTION!** Ensure that receiver power and network connections are maintained during a firmware update. Do not turn off the receiver until the update is complete.

1. From Wireless Workbench, open the Firmware Update Manager: *Tools > Shure Update Utility*.
2. Click *Check Now* to view new versions available for download.
3. Select the updates and click *download*.
4. Connect the receiver and computer to the same network.
5. Download the latest firmware to the receiver.

## Updating the Transmitter Firmware

1. From the Device Configuration menu of the receiver: *Tx Firmware Update*.
2. Turn on the transmitter and align the IR sync windows on the transmitter and receiver. The red alignment LED will illuminate when alignment is correct.
3. Maintain alignment and press *ENTER* on the receiver to begin the update.

Alignment must be maintained during the entire update cycle. Percentage of update progress appears on the receiver display. The receiver display will show the message *Complete!* when finished.

# Audio Settings

## Adjusting Channel Gain and Audio Output

The gain and audio output can be individually controlled in real time for each channel.

Select a channel and navigate to the *Audio* menu, and then choose *Gain/Mute*.

To adjust the gain:

1. Use the control wheel to select the *GAIN* option.
2. Turn the control wheel to adjust the gain from -18 dB to +42 dB in real time.
3. Press *EXIT* to finish.

Tip: Adjust the gain while performing a sound check using typical audio input signal levels and monitor the audio meter LEDs. Reduce the gain if the red LED triggers repeatedly.

To control the audio output:

1. Use the control wheel to select the *OUTPUT* option.
2. Use the control wheel to select *On* or *Mute* in real time.
3. Press *EXIT* to finish.

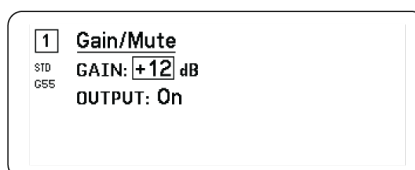

# Tone Generator

The receiver features a built-in tone generator to provide a continuous audio signal which is useful for sound checks and for system troubleshooting. The level and frequency of the tone are adjustable.

*Note: The tone generator enters the signal chain before the system gain. The overall system gain will affect the level of the tone.*

1. From the Channel menu: *Audio > Tone Generator*
2. Use the control wheel to select a level and frequency for the tone.
3. Press *ENTER* to save.

Tip: Set the *Level* to *Off* to stop the generator.

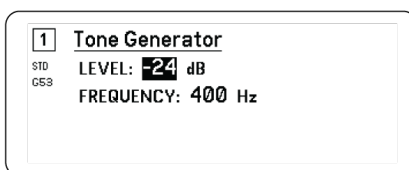

# Headphone Monitoring

The headphone monitoring jack provides options for listening to a selected receiver channel or for accessing and monitoring audio from Dante-enabled devices on your network.

To listen to a receiver channel, select the channel number and use the volume knob to adjust the signal level.

## Headphone Monitoring Options

Advanced headphone options allow you to monitor the audio from Dante devices on your network and to adjust the headphone settings.

Access the *Headphone Monitor* menu by pressing the headphone volume knob. Use the control wheel to select one of the following options:

### Dante Browse

Press the control wheel to search your network for Dante channels. Scroll to select and monitor a device with the headphones.

### Dante Cue

Use the control wheel to configure the receiver as a *Cue Station*, allowing the receiver to act as a central monitoring point for your system. You can add additional channels to *Cue Groups*. Channels in the *Cue Group* can be monitored by pressing and holding the channel button on the source receiver.

### Headphone Settings

Configuration options:

- *LIMITER THRESHOLD*: Adjusts the trigger point for the headphone limiter to protect against unexpected increases in signal level
- *FD-S PRE/POST SELECTION*: Selects a audio monitoring point in the signal path before or after Frequency Diversity processing for the headphone. This setting is useful for isolating sources of noise or interference.

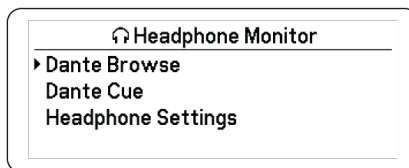

## System Gain

The System Gain feature allows you to view and calculate all gain stages in the signal chain, including input pads, offsets, and receiver gain. Audio output levels are updated in real time as gain adjustments are made.

1. From a selected *Channel* menu: *Audio > System Gain*
2. The display shows the pads and the offsets for transmitters and the receiver gain setting.
3. Use the control wheel to adjust the receiver gain in real time while monitoring the net output levels at the 1/4" (6.3 mm) output and the XLR output.
4. Press *EXIT* when finished.

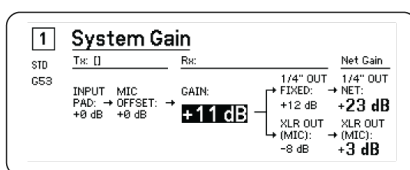

## Networking

### Networking Receivers

The receiver features a 4-port network interface. Dante technology provides an integrated solution to distribute digital audio. Dante uses standard IP over Ethernet and safely coexists on the same network as IT and control data. Selectable networking modes route port signals for flexible network set up.

### Network Control Software

Receivers can be controlled by Shure Control (Wireless Workbench) for remote management and monitoring. The Dante Controller manages digital audio routing. Signals for AMX and Crestron controllers are carried on the same network as Shure Control.

#### Shure Control

Wireless Workbench 6 (WWB6) software provides comprehensive control for wireless audio systems. Wireless Workbench enables remote adjustments to networked receivers for real-time changes to gain, frequency, RF power, and control locks. A familiar channel strip interface displays audio meters, transmitter parameters, frequency settings, and network status.

#### Dante

The Dante Controller is a free software program created by Audinate™ to configure and manage networks of Dante-enabled devices. Use the Controller to create audio routes between networked components and to monitor the status of on-line devices.

## Networking Modes and Switch Configuration

The receiver offers two selectable networking modes:

- *Split/Redundant*: This mode places Dante audio and Shure control on separate networks, while allowing you to take advantage of Dante redundancy.
- *Switched*: In Switched mode, the receiver acts as a 4-port network switch. Shure control and Dante audio are present on all network ports.

From the factory, the receiver is configured to *Split/Redundant* mode.

To Configure the switch mode:

1. *Device Configuration > Network Configuration*.
2. Select *Setup* to enter the *Switch Configuration* menu.
3. Use the control wheel to change the mode.
4. Press *ENTER* to reboot the receiver and change the mode.

## IP Address Configuration

An IP address must be assigned to each device in the network to ensure communication and control between components. Valid IP addresses can be assigned automatically using a DHCP server or manually from a list of valid IP addresses. If using Dante audio, a separate Dante IP address must also be assigned to the receiver.

### Automatic IP Addressing Mode

1. If using a DHCP capable Ethernet switch, set the DHCP switch to ON.
2. From the Device Configuration menu: *Network Configuration > Next*
3. Press the control wheel to enable editing of the *Mode*, and then set the mode to *Automatic*.

### Manual IP addressing Mode

1. From the Device Configuration menu: *Network Configuration > Next*
2. Press the control wheel to enable editing of the *Mode*, and then set the mode to *Manual*
3. Set valid IP addresses and subnet values, and then press *ENTER* to save.

## Network Browser

The network browser allows you to discover other devices connected to your network. You can view information about the discovered devices, including Device ID, IP address, firmware version, and model name.

1. From the *Device Configuration* menu: *Network Browser*
2. When selected, the Network Browser will discover and list devices on the network.
3. Use the control wheel to scroll through and select devices.

The following information and actions are available from the Network Browser:

- *Show*: Selects the device from the list
- *Flash*: Flashes front panel LEDs
- *Info*: Displays the device ID, model, IP address, and firmware version
- *Flash All*: Flashes the front panel of all devices

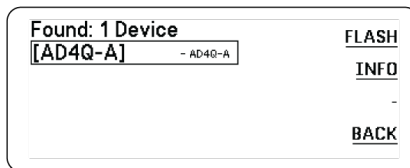

## Network Troubleshooting

- Use only one DHCP server per network
- All devices must share the same subnet mask
- All receivers must have the same level of firmware revision installed
- Look for the illuminated network icon on the front panel or display of each device:

If the icon is not illuminated, check the cable connection and the LEDs on the network jack.

If the LEDs are not on and the cable is plugged in, replace the cable and recheck the LEDs and network icon.

To check connectivity of WWB6 to the network:

1. Start Wireless Workbench software and use Inventory view to see devices connected to the network.
2. Find the IP address from one of the devices on the network and see if you can ping it from the computer running Wireless Workbench.
3. From a WINDOWS/MAC command prompt, type 'ping IPADDRESS' of the device (e.g. "ping 192.168.1.100").
4. If the ping returns success (no packet loss), then the computer can see the device on the network. If the ping returns failure (100% packet loss), then check the IP address of the computer to ensure it's on the same subnet.
5. If the pings are successful and the devices still do not show up in the WWB6 inventory, check to ensure all firewalls are either disabled or allow the WWB network traffic to pass to the application. Check that firewall settings are not blocking network access.

---

## Operation

### Assigning a Device ID

Assigning custom names or IDs helps with monitoring and organizing when the receiver is part of a large system.

1. From the *Device Configuration* menu: *Device ID*
2. Press and rotate the control wheel to edit the ID.
3. Press *ENTER* to save.

### Assigning a Channel Name

Assigning unique names to each channel helps with identification and organization when the receiver is part of a large system.

1. Select a channel, and then navigate to *Channel Name*.
2. Press the control wheel to enable editing, and then turn and press the wheel to edit.
3. When finished, press *ENTER* to save.

## Locking and Unlocking the Controls

Use the locking feature to prevent accidental or unauthorized changes to controls and settings. The front panel and power switch can be independently locked or unlocked.

1. From the *Device Configuration* menu: *Locks*
2. Use the control wheel to change the lock status for the front panel controls or the power switch.
3. Press *ENTER* to save.

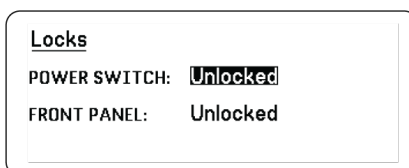

## Display Screen Options

The receiver offers the following display options:

- *Brightness: Low, Medium, High, Auto*
- *Invert: White text on black or black text on white*
- *Display Sleep: Offers options to turn off display and front panel illumination after 10, 30, or 60 seconds*

Tip: Press any front panel control to interrupt *Display Sleep*.

1. From the *Device Configuration* menu: *Display*
2. Use the control wheel to edit the settings for *Brightness, Invert, or Sleep Display*.
3. Press *ENTER* to save.

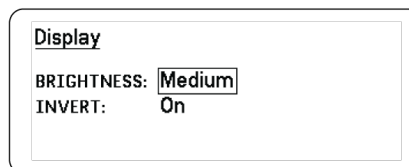

## Saving Receiver Settings as User Presets

User presets allow a current receiver setup to be saved and restored. Presets store all receiver settings to provide a quick way to configure a receiver or switch between several different setups. Up to 4 presets can be stored in receiver memory.

From the *Device Configuration* menu, navigate to *User Presets* and choose one of the following options:

- *Restore a User Preset: Use the control wheel to select a previously saved preset*
- *Save a User Preset: Use the control wheel to save the current receiver settings as a preset*
- *Delete a User Preset: Use the control wheel to select and delete a preset*

## Programming Transmitters Using IR Presets

Configuring IR presets allow all transmitter parameters to be automatically set from the receiver during an IR sync.

Individual parameters can be configured in the *IR Presets* menu. Each preset has the default value of *No Change*, which leave that setting unchanged by an IR sync.

1. Select from the channel menu: *IR Presets*
2. Use the control wheel to select and edit parameters from the preset list. Select *No Change* to keep existing settings.
3. Press *ENTER* to save.

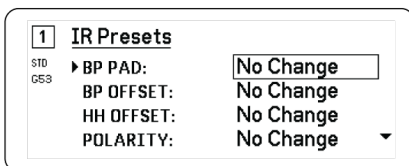

## Encryption

The receiver features Advanced Encryption Standard (AES-256) to ensure that only the receiver that is keyed to the transmitter can monitor the audio content.

*Note: When enabled, encryption is applied to all receiver channels. Encryption does not affect Dante audio signals, audio quality, or channel spacing.*

1. From the Device Configuration menu: *Device RF > Encryption*.
2. Use the control wheel to select *On*.
3. Press *ENTER* to save.
4. Perform an IR sync to complete the encryption between the transmitter and the receiver. The encryption key icon will appear on the display of both the receiver and the transmitter.

*Note:*

Any change to the encryption status on the receiver such as enabling/ disabling encryption or requesting a new encryption key, requires a sync to send the settings to the transmitter.

Tip: To remove encryption, use the control wheel to select *Off* and re-sync the transmitter to clear the encryption.

## Restoring the Receiver to Factory Settings

The *Factory Reset* function clears the current settings and restores the factory settings.

Caution: All current settings will be cleared during the reset and the receiver will need to reboot.

1. From the *Device Component* menu: *Factory Reset*
2. Press *ENTER* to reset the receiver, or press *EXIT* to return to the *Device Configuration* menu.

## Cooling Fan

The receiver contains an internal cooling fan to protect against over-temperature conditions.

1. From the *Device Configuration* menu: *Fan*
2. Select from the following fan setting options:
  - *Auto*: The fan will automatically turn on if the receiver temperature rises
  - *On*: The fan will run continuously to offer maximum cooling in warm environments

Tip: The internal receiver temperature is shown on the *Fan* display screen.



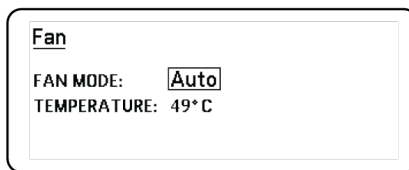

## Troubleshooting

Issue	See Solution...
No sound	Power, Cables, Radio Frequency, or Encryption Mismatch
Faint sound or distortion	Gain, Cables
Lack of range, unwanted noise bursts, or dropouts	Radio Frequency (RF)
Cannot turn transmitter off or change frequency settings, or can't program receiver	Interface Locks
Encryption Mismatch message	Encryption Mismatch
Firmware Mismatch message	Firmware Mismatch
Antenna Fault Red LED	RF

### Power

Make sure that the receiver and transmitter are receiving sufficient voltage. Check the battery indicators and replace the transmitter batteries if necessary.

### Gain

Adjust the system gain on the front of the receiver. Ensure the output level on the back of the receiver corresponds to the mic/line input setting of the mixing console, amplifier, or DSP.

### Cables

Check that all cables and connectors are working correctly.

### Interface Locks

The transmitter and the receiver can be locked to prevent accidental or unauthorized changes. A locked feature or button will produce the *Locked* screen on the LCD panel or the lock icon will flash on a transmitter.

### Encryption Mismatch

Re-sync all receivers and transmitters after enabling or disabling encryption.

---

## Firmware Mismatch

Paired transmitters and receivers must have the same firmware version installed to ensure consistent operation. See Firmware topic for firmware update procedure.

## Radio Frequency (RF)

### RF LEDs

If neither blue *RF* Diversity LED is illuminated, then the receiver is not detecting the presence of a transmitter.

The orange *RF* Signal Strength LEDs indicate the amount of RF power being received. This signal could be from the transmitter, **or it could be from an interfering source, such as a television broadcast**. If more than two of the orange *RF* LEDs are still illuminated while the transmitter is off, then that channel may be experiencing interference, and you should try a different channel.

The red *RF* LED indicates RF overload. Overloads have the potential to cause interference in multiple system installations. If you are experiencing an overload, turn off the receiver to see if it is causing interference with other components.

### Compatibility

- Perform a Scan and Sync to ensure the transmitter and receiver are set to the same group and channel.
- Look at the band label on the transmitter and make sure the receiver is set to the same band.

### Reducing Interference

- Perform a group or channel scan to find the best open frequency. Perform a sync to transfer the setting to the transmitter.
- For multiple systems, check that all systems are set to channels in the same group (systems in different bands do not need to be set to the same group).
- Maintain a line of sight between transmitter and receiver antennas.
- Move or point receiver antennas away from metal objects or other sources of RF interference (such as LED walls, computers, digital effects, network switches, network cables and Personal Stereo Monitor (PSM) wireless systems).
- Eliminate RF overload (see below).

### Increasing Range

If the transmitter is more than 6 to 60 m (20 to 200 ft) from the receiver antenna, you may be able to increase range by doing one of the following:

- Reduce interference (see above).
- Increase transmitter RF power level.
- Use Normal mode instead of High Density mode.
- Use an active directional antenna, antenna distribution system, or other antenna accessory to increase RF range.

## Eliminating RF Overload

If you see the red RF LED on a receiver, try the following:

- Reduce the transmitter RF power level
- Move the transmitter further away from the receiver—at least 6 m (20 ft)
- If you are using active antennas, reduce antenna or amplifier gain.
- Use omnidirectional antennas

## Antenna Faults

The *Antenna Fault* red LED indicates a short circuit condition or excessive load at an antenna port.

- Check antennas and cables for damage
- Ensure that antenna ports are not overloaded
- Check antenna bias voltage setting. Turn off voltage if using passive antennas.

# Specifications

## System Specifications

### RF Carrier Frequency Range

470–960 MHz, varies by region (See frequency table)

### Working Range

100 m (330 ft)

Note: Actual range depends on RF signal absorption, reflection and interference.

### RF Tuning Step Size

25 kHz, varies by region

### Channel-to-Channel Spacing

<b>Standard Mode</b>	350 kHz
<b>High Density Mode</b>	125 kHz

varies by region

### Channel-to-Channel Spacing

<b>Standard Mode</b>	350 kHz
----------------------	---------

**High Density Mode**

125 kHz

varies by region

**Image Rejection**

&gt;70 dB, typical

**RF Sensitivity**-98 dBm at  $10^{-5}$  BER**Latency Analog Output**

<b>STD</b>	2.08 ms
<b>HD</b>	2.96 ms

**Audio Frequency Response**

<b>AD1</b>	20 – 20 kHz ( $\pm 1$ dB)
<b>AD2</b>	Note: Dependent on microphone type

**Signal-to-Noise Ratio(Dynamic Range)***typical, 20 Hz to 20 kHz, receiver gain setting = -12 dB*

	<b>A-Weighted</b>	<b>Unweighted</b>
<b>XLR Line Output</b>	120 dB	117 dB
<b>Digital (AES3/Dante)</b>	130 dB	126 dB

**Total Harmonic Distortion***-6 dBFS, 1 kHz, System Gain @ +10*

&lt;0.01%

**System Audio Polarity**

Positive pressure on microphone diaphragm produces positive voltage on pin 2 (with respect to pin 3 of XLR output) and the tip of the 6.35 mm (1/4-inch) output.

**Operating Temperature Range**

-18°C (0°F) to 50°C (122°F)

Note: Battery characteristics may limit this range.

### Storage Temperature Range

-29°C (-20°F) to 65°C (149°F)

## Audio Output

### Gain Adjustment Range

-18 to +42 dB in 1 dB steps (plus Mute setting)

### Configuration

<b>XLR</b>	Transformer Coupled Balanced (1=ground, 2=audio +, 3=audio -)
<b>TRS</b>	Transformer Coupled Balanced (Tip = Audio +, Ring = Audio -, Sleeve = Ground)

### Impedance

100  $\Omega$ , Typical, XLR Line Out

### Full Scale Output (200K $\Omega$ load)

<b>LINE setting</b>	+18 dBV
<b>MIC setting</b>	-12 dBV
<b>TRS</b>	+8 dBV

### Mic/Line Switch

30 dB pad

### Phantom Power Protection

Yes

### Dimensions

44 x 483 x 333 mm H x W x D

## Weight

4.6 kg (10.1 lbs), without antennas

## Housing

Steel; Extruded aluminum

## Power Requirements

100 to 240 V AC, 50-60 Hz, 0.55 A max.

## Thermal Power Dissipation

<b>Maximum</b>	23 W (78 BTU/hr)
<b>Idle</b>	15 W (51 BTU/hr)

## DC Power Requirements

10.9 to 14.8V DC , 3.3 A max.

## Network Interface

10/100 Mbps, 1Gbps, Dante Digital Audio

## Network Addressing Capability

DHCP or Manual IP address

## Maximum Cable Length

100 m (328 ft)

## Cascade Output

### Connector Type

BNC

Note: For connection of one additional receiver in the same band

## Configuration

Unbalanced, passive

## Impedance

50  $\Omega$ 

## Insertion Loss

0 dB, typical

## RF Input

## Spurious Rejection

&gt;80 dB, typical

## Connector Type

BNC

## Impedance

50  $\Omega$ 

## Bias Voltage

12 to 13.5 V DC, 150 mA maximum, per antenna

switchable on-off

## RF Carrier Frequency Range model dependent

<b>AD4D=A</b>	470–636 MHz
<b>AD4D=B</b>	606–810 MHz
<b>AD4D=C</b>	750–960 MHz

## Tables and Diagrams

### Audio Output

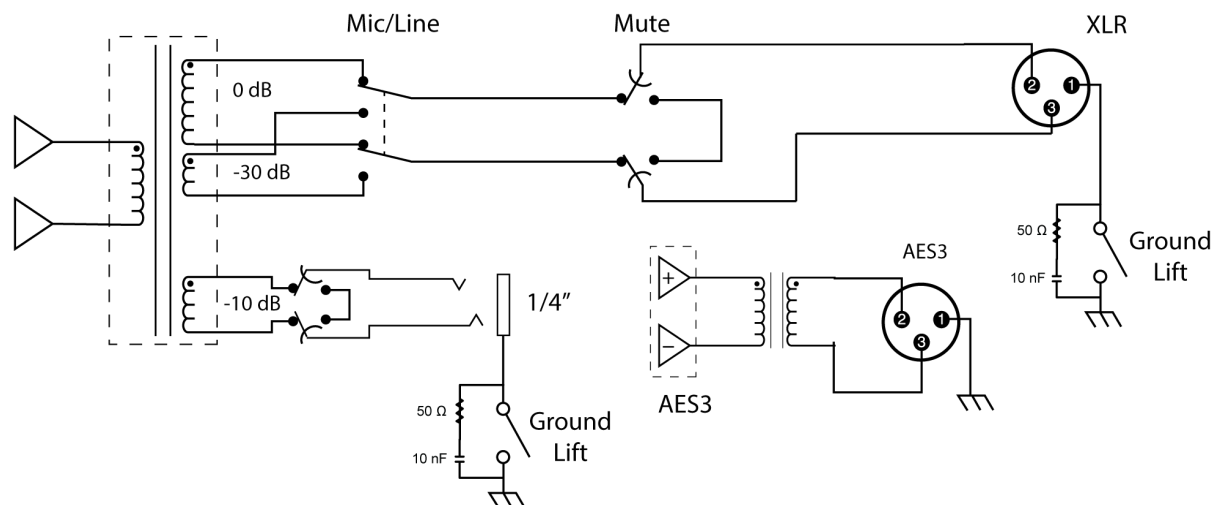

### XLR to 1/4" Output

Use the following wiring diagram to convert the XLR output to a 1/4" output.

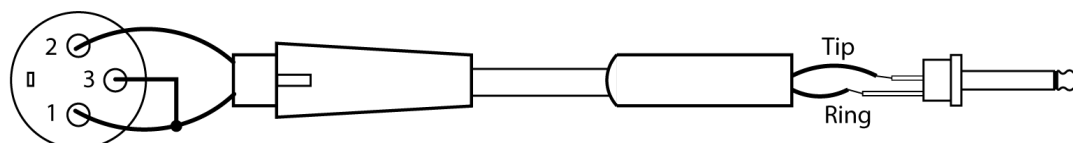

## Receiver Frequency Bands

Band	Frequency Range (MHz)
G53	470 to 510
G54	479 to 565
G55†	470 to 636*
G56	470 to 636
G57 (G57+)	470 to 616* (614 to 616*** )
G62	510 to 530



Band	Frequency Range (MHz)
H54	520 to 636
K53	606 to 698*
K54	606 to 663**
K55	606 to 694
K56	606 to 714
K57	606 to 790
K58	622 to 698
L54	630 to 787
R52	794 to 806
JB	806 to 810
X51	925 to 937.5
X55	941 to 960

\*with a gap between 608 to 614 MHz.

\*\*with a gap between 608 to 614 MHz and a gap between 616 to 653 MHz.

\*\*\*selecting the G57+ band extends the G57 band with 2 MHz of additional spectrum between 614 to 616 MHz. Maximum transmitter power is limited to 10mW between 614 to 616 MHz.

†operation mode varies according to region. In Brazil, High Density mode is used.

## Certifications

This product meets the Essential Requirements of all relevant European directives and is eligible for CE marking.

Approved under the Declaration of Conformity (DoC) provision of FCC Part 15.

Conforms to electrical safety requirements based on IEC 60065.

Meets essential requirements of the following European Directives:

- WEEE Directive 2002/96/EC, as amended by 2008/34/EC
- RoHS Directive 2011/65/EU

*Note: Please follow your regional recycling scheme for batteries and electronic waste*

This product meets the Essential Requirements of all relevant European directives and is eligible for CE marking.

Hereby, Shure Incorporated declares that the radio equipment is in compliance with Directive 2014/53/EU. The full text of the EU declaration of conformity is available at the following internet address: <http://www.shure.com/europe/compliance>

Authorized European representative:

Shure Europe GmbH

Headquarters Europe, Middle East & Africa

Department: EMEA Approval

Jakob-Dieffenbacher-Str. 12

---

75031 Eppingen, Germany  
Phone: +49-7262-92 49 0  
Fax: +49-7262-92 49 11 4  
Email: EMEAsupport@shure.de

## Canada Warning for Wireless

This device operates on a no-protection, no-interference basis. Should the user seek to obtain protection from other radio services operating in the same TV bands, a radio licence is required. For further details, consult Innovation, Science and Economic Development Canada's document Client Procedures Circular CPC-2-1-28, Voluntary Licensing of Licence-Exempt Low-Power Radio Apparatus in the TV Bands.

Ce dispositif fonctionne selon un régime de non-brouillage et de non-protection. Si l'utilisateur devait chercher à obtenir une certaine protection contre d'autres services radio fonctionnant dans les mêmes bandes de télévision, une licence radio serait requise. Pour en savoir plus, veuillez consulter la Circulaire des procédures concernant les clients CPC.2.1.28, Délivrance de licences sur une base volontaire pour les appareils radio de faible puissance exempts de licence et exploités dans les bandes de télévision d'Innovation, Sciences et Développement économique Canada.