



Front Surround System

YAS-209

[YAS-CU209 + NS-WSW44]

EN Quick Start Guide



Contents

About this Quick Start Guide 2

INTRODUCTION 4

Features 4

Accessories 7

Part names and functions 8

PREPARATION 12

① Preparation 12

② Connections 12

③ Tuning on the unit 14

④ Connecting to a network 14

PLAYBACK 15

Basic procedure for playback 15

Selecting sound preferences 16

Useful features for playback 17

Listening to audio from a Bluetooth device 18

Streaming services 18

Operating the unit using voice commands

(Amazon Alexa) 19

About this Quick Start Guide

This Quick Start Guide was created for users of this unit. It primarily covers the following.

- **Connecting a TV that supports Audio Return Channel (ARC), and A/V devices such as those for streaming media**
- **Connecting to a wireless network**
- **Basic use**
- **Amazon Alexa**

This document provides step-by-step instructions for installation and playback. Refer to the Owner's Manual on the Yamaha website for troubleshooting or when more information is required.

Follow one of the methods described below to view the latest Owner's Manual.

In HTML format

- Scan the QR code found on the front cover of this document.
- Visit the following website:
<https://manual.yamaha.com/av/19/yas209/>

In PDF format

Visit the following website:
<https://download.yamaha.com/>

[For U.S. customers only]

Visit the following website for additional information, FAQ's, downloads such as "Owner's Manual" and product updates:
<http://usa.yamaha.com/support/>

- The terms HDMI, the HDMI Logo, and High-Definition Multimedia Interface are trademarks or registered trademarks of HDMI Licensing LLC in the United States and other countries.
- In this manual, iOS and Android mobile devices are collectively referred to as "mobile devices." The specific type of mobile device is noted in explanations as needed.

Notice for content in this manual

- This manual uses the following signal words for important information:
 - **NOTICE**
Indicates points that you must observe in order to prevent product failure, damage or malfunction and data loss, as well as to protect the environment.
 - **NOTE**
Indicates notes on instructions, restrictions on functions, and additional information that may be helpful.
- The illustrations and screenshots in this document are for instructional purposes only. For any information on devices other than this unit, refer to each device's respective documentation.
- **TRADEMARKS:**
 - DTS, the Symbol, DTS and the Symbol together, DTS Digital Surround, and DTS Virtual:X are registered trademarks or trademarks of DTS, Inc. in the United States and/or other countries. © DTS, Inc. All Rights Reserved.
 - Amazon, Alexa, Amazon Music, Kindle and all related logos are trademarks of Amazon.com, Inc. or its affiliates.
 - App Store is a service mark of Apple Inc.
 - Android and Google Play are trademarks of Google LLC.
 - The Bluetooth® word mark and logos are registered trademarks owned by Bluetooth SIG, Inc. and any use of such marks by Yamaha Corporation is under license. Other trademarks and trade names are those of their respective owners.
 - QR Code is a registered trademark of DENSO WAVE INCORPORATED in Japan and in other countries.

INTRODUCTION

This unit is a front surround system that allows for the enjoyment of superior sound quality from video played on a TV connected to the unit.

Features

Play surround sound



Ask Alexa to control the unit

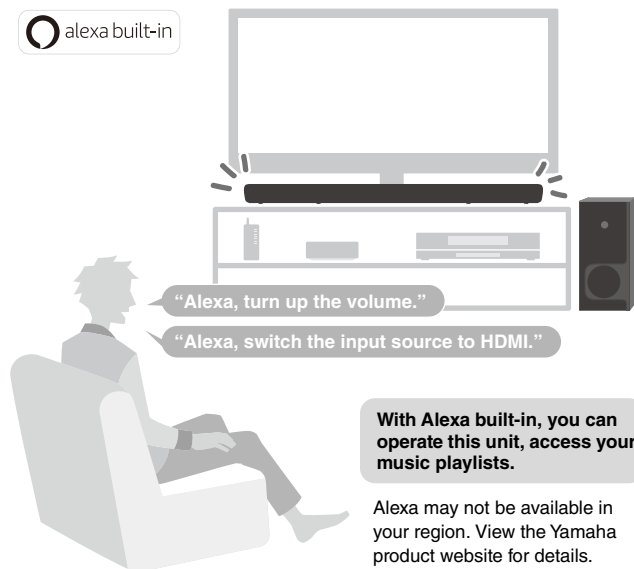

Easy operation with the smartphone app



Listen to audio from Bluetooth® devices and streaming services

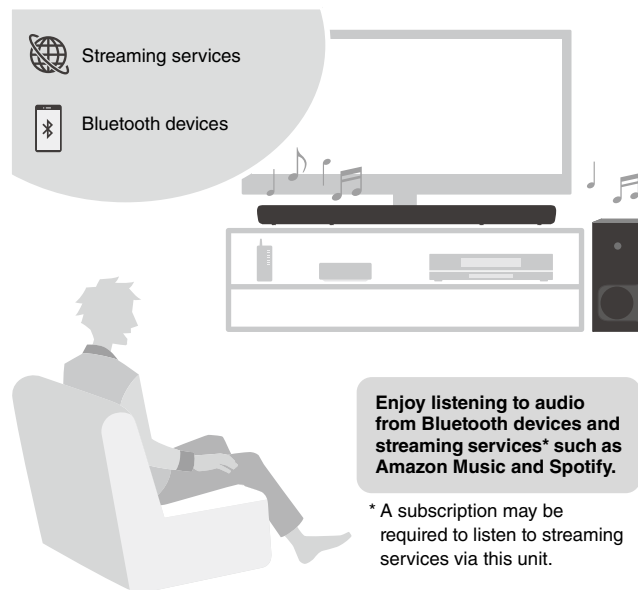

3D surround playback

This unit supports virtual 3D surround sound technology called “DTS Virtual:X”. Surround sound can be heard not only from horizontal directions, but also from varying heights when this unit’s 3D surround mode is enabled, creating a virtual acoustic environment. This provides a greater sense of cohesion between audio and video, for a sense of being surrounded by sounds coming from ahead, behind, the left and right, and even above for an immersive visual and auditory experience.

Wireless subwoofer

The supplied wireless subwoofer enables more dynamic audio playback.

Transmission of 4K high dynamic range (HDR) video

Enjoy 4K High Dynamic Range (HDR) content from HDR-compatible sources such as a TV, media streaming device, gaming console, or set-top box.

HDMI control function

Link functions of a TV and the unit are available using the TV’s remote control. When a TV that supports Audio Return Channel (ARC) is used, this ARC-compatible unit can be connected to the TV via a single HDMI cable.

Bass Extension

The bass extension feature boosts bass levels for more impactful sound.

Clear Voice

The clear voice function makes speech, such as dialog and narration, clearer.

Accessories

Make sure you have received all of the following accessories.

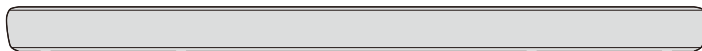

Center unit (YAS-CU209)



Power cord x 2



Optical digital audio cable

Use when connecting the unit to a TV that does not support ARC.



Quick Start Guide (this booklet)



Safety Brochure

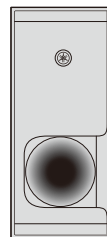

Wireless subwoofer (NS-WSW44)

In this manual, the wireless subwoofer is referred to as "subwoofer."



Remote control

A CR2025 Lithium battery has already been inserted into the remote control.



Mounting template

Use when mounting the unit on a wall.

■ NOTE

- HDMI cables are not supplied with the unit. Use the HDMI cables purchased separately.
- The Owner's Manual is available on the Yamaha website. Scan the QR code found on the front cover of this document to visit the website. For more information, see page 2.

Part names and functions

Front/top panel

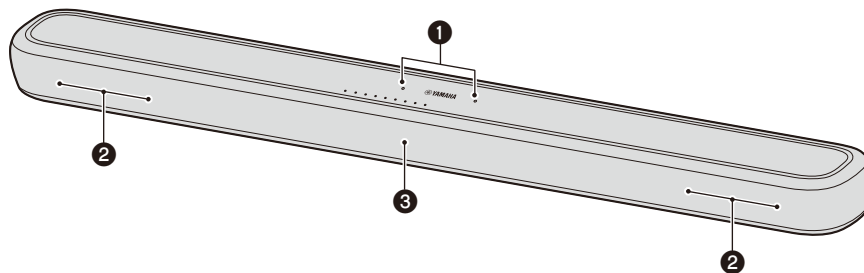

1 Microphones

Used to interact with Alexa.

2 Speakers

3 Remote control sensor

Receives infrared (IR) signals from the remote control of the unit. Operate the remote control within the range as shown below.

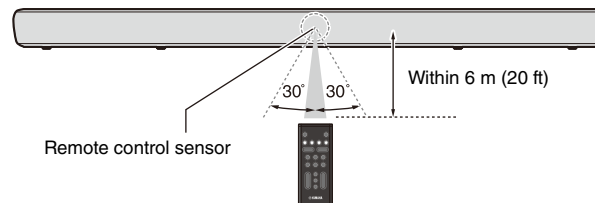

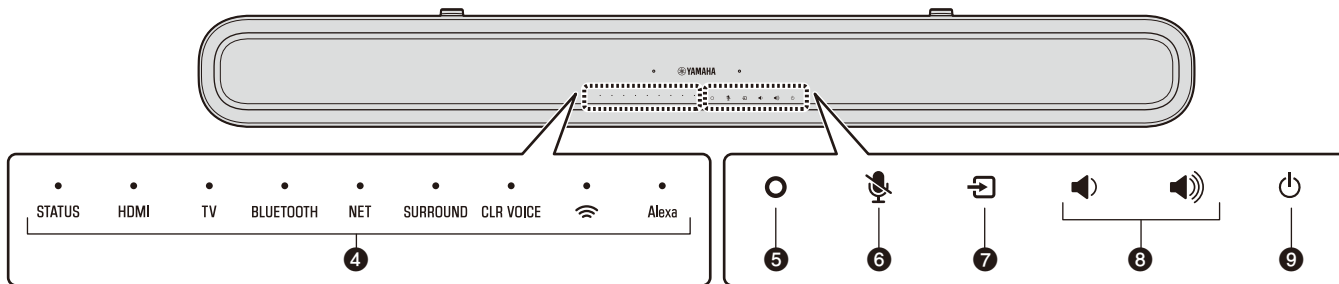

4 Indicators

The indicators on the top panel flash or glow to show the operation and setting status. In this document, indicator status, such as off, glowing, and flashing, are shown as the illustrations below.



Off



Glowing



Flashing

5 (Alexa)

Manually wake Alexa to enable a voice command (p. 19).

6 (Microphones disabled)

Touch to disable the microphones. Alexa will not respond to utterances while the microphones are disabled. Disable the microphones to maintain privacy. Touch again to enable the microphones (p. 19).

7 (input)

Select an input source (p. 15).

8 / (volume +/-)

Adjust the volume (p. 15).

9 (power)

Turn on or off the unit.

Rear panel

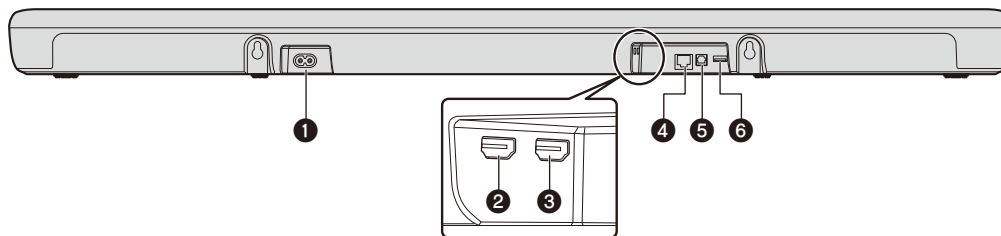

1 Power connector

Connect the power cord (p. 13).

2 HDMI IN jack

Connect to an HDMI-compatible AV device to input video/audio signals (p. 13).

3 HDMI OUT (ARC) jack

Connect to an HDMI (ARC)-compatible TV to output video/audio signals (p. 13). TV audio signals can also be input through this jack.

4 NETWORK jack

For connecting to a network with an ethernet cable (sold separately).

5 TV input jack

For connecting to a TV that does not support ARC. This jack cannot be used when the unit is connected to an ARC-compatible TV.

6 UPDATE ONLY jack

Use to update this unit's firmware, if necessary. Refer to the instructions supplied with the firmware for details.

Subwoofer

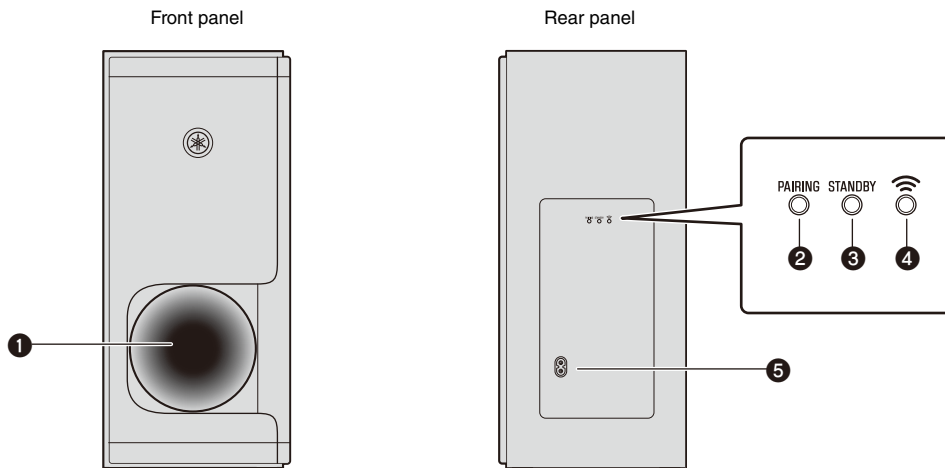

1 Bass reflex port

2 PAIRING button

Use to pair the center unit with the subwoofer manually.

3 STANDBY indicator

Shows subwoofer's status.

4  indicator

Glows when the center unit and subwoofer are connected wirelessly.

5 Power connector

Connect the power cord (p. 13).

PREPARATION

1 Preparation

Installing the unit on a TV stand

Install the unit as shown below.

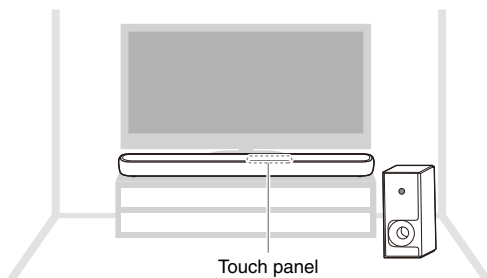

Preparing the remote control

Remove the battery insulating strip before attempting to use the remote control.

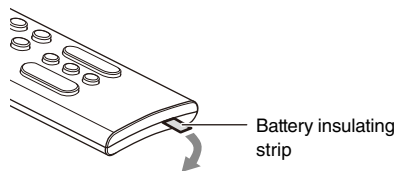

2 Connections

Overview

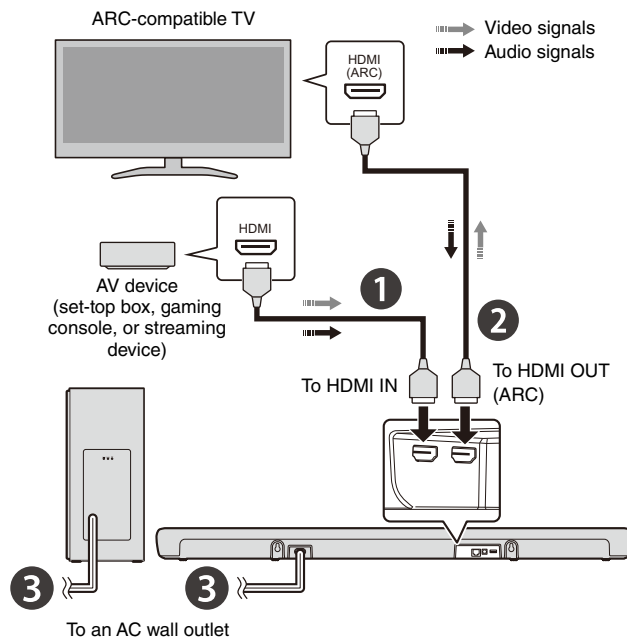

1 Connecting an AV device

Connect a streaming device, set-top box, or other AV device to the unit. If only a TV will be connected, skip this step and proceed to step 2.

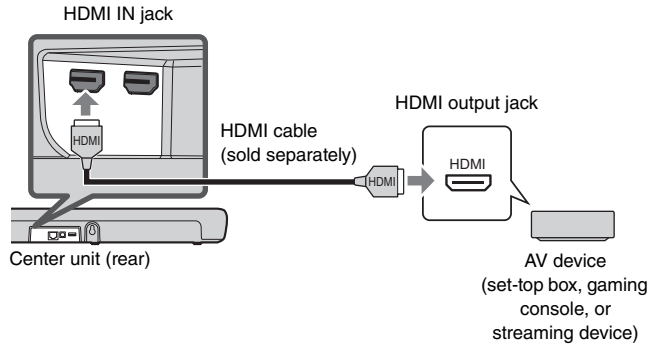

2 Connecting an Audio Return Channel (ARC) compatible TV

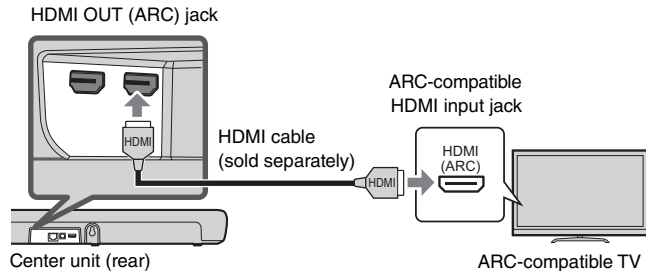

3 Connecting the power cord

Once all connections have been made, connect the supplied power cords to the power connectors on the center unit and subwoofer respectively, and plug both power cables into AC wall outlets.

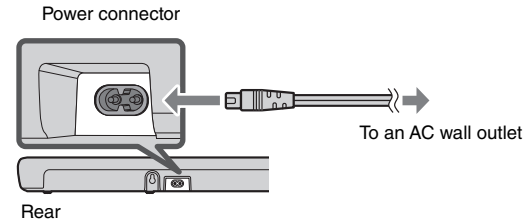

Center unit

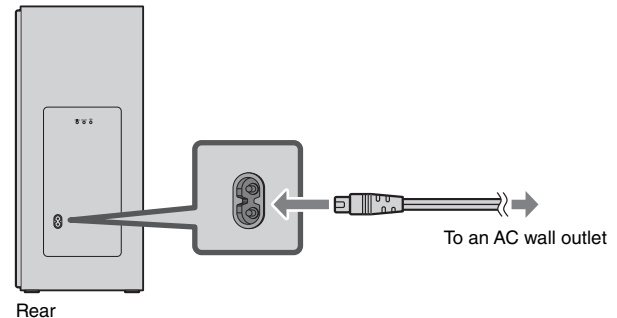

Subwoofer



3 Turing on the unit

Press  on the remote control or touch  on the center unit to turn on the unit.

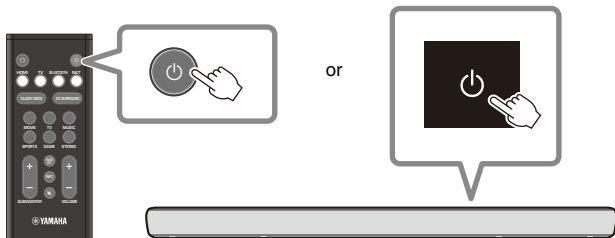

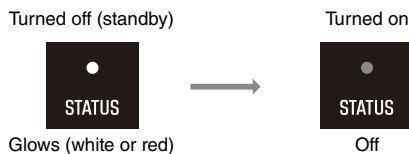

When the unit is turned on, the STATUS indicator on the center unit goes off.



The center unit and subwoofer are automatically connected via wireless connection, and the unit is ready for playback.

■ NOTE

To turn off the unit, press  on the remote control or touch  on the center unit again.

4 Connecting to a network

A network connection allows you to play various streaming services via the unit, and to talk with Amazon Alexa to operate this unit, or to play music.

The Sound Bar Controller app for mobile devices is required to configure and operate network functions. Search for “Sound Bar Controller” on the App Store or Google Play.

Follow the app’s on-screen instructions to connect the unit to a network.

The  indicator on the center unit glows when the unit is connected to a wireless network.

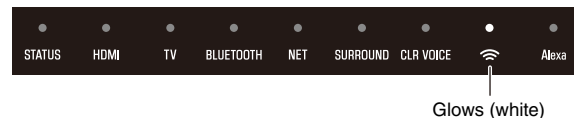

■ NOTE

- Follow the app’s on-screen instructions to enter your Amazon account information to use Amazon Alexa.
- When the unit is connected to a network for the first time after purchase, the unit’s firmware is updated to the latest firmware version.

PLAYBACK

Basic procedure for playback

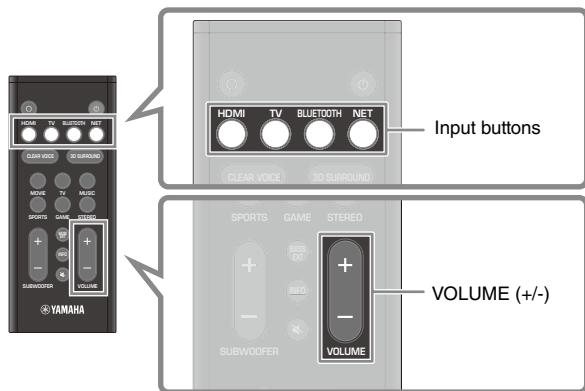

- 1 Turn on the external devices (such as a TV or media streaming device) connected to the unit.**

- 2 Use the input buttons to directly select an input source to be played.**

HDMI: Sound from a device connected to the HDMI IN jack

TV: TV audio

BLUETOOTH: Sound from a Bluetooth device

NET: Audio from streaming services

- 3 Start playback on the external device selected in step 2.**

- 4 Press VOLUME (+/-) to adjust the volume.**

■ NOTE

When the unit is connected to a TV via HDMI cable as described in this document, the TV's remote control can be used to perform the following operations.

- **Turn on/off**
Both the TV and the unit turn on/off at the same time.
- **Switch input sources**
The unit's input source switches accordingly when the TV's input source is switched.
- **Switch the audio output device**
The audio output device can be switched to the TV or the unit.
- **Adjust volume**
The unit's volume can be adjusted when the TV's audio output is set to the unit.

Selecting sound preferences

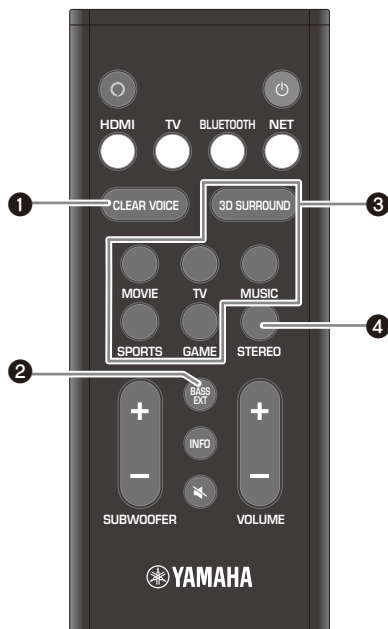

❶ CLEAR VOICE button

Press the button to enable or disable the clear voice function. Human voices such as lines in movies and TV shows are heard clearly when the function is enabled.

❷ BASS EXT button

Press the button to enable or disable the bass extension function. You can enjoy enhanced bass sound and more powerful sound when the function is enabled.

❸ 3D SURROUND button and surround mode buttons

3D SURROUND button

3D surround playback and surround playback switch alternately each time the button is pressed.

When 3D surround playback is selected, DTS Virtual:X makes it possible to hear sound not only from horizontal directions, but also from varying heights.

3D surround playback



Glow (blue)

Surround playback



Glow (white)

Surround mode buttons

Select the surround mode (MOVIE, TV, MUSIC, SPORTS, or GAME) best suited to the content viewed or listened to when 3D surround sound playback or surround playback is enabled.

❹ STEREO button

Press the button to switch to 2-channel stereo playback.

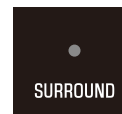

Off

Useful features for playback

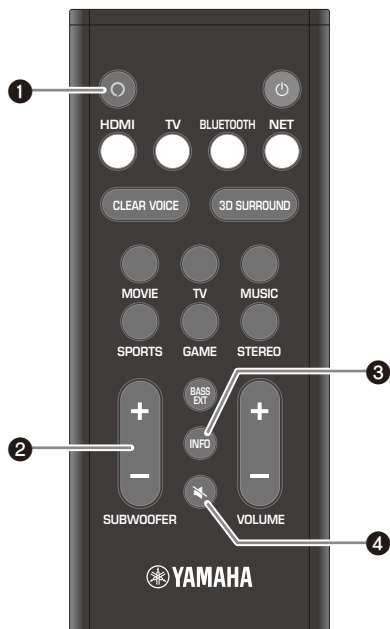

❶ (Alexa) button

Manually wake Alexa to enable a voice command.

❷ SUBWOOFER (+/-) button

Adjust the volume of the subwoofer.

❸ INFO button

Confirm the type of audio signal being played, as well as settings for functions.

❹ (mute) button

Mute the audio output. Press the button again to unmute.

Listening to audio from a Bluetooth device

Audio content from a Bluetooth device (such as a smartphone, tablet, laptop, or digital music player) can be played through this unit over a wireless connection.

Bluetooth device

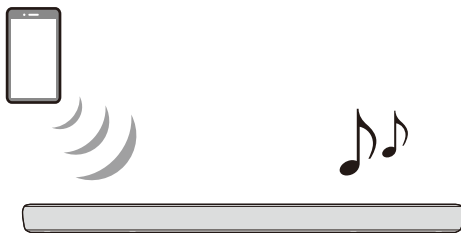

1 Press BLUETOOTH to select “Bluetooth” as the input source.

2 On the Bluetooth device, enable the Bluetooth function.

The Bluetooth device list appears on the Bluetooth device.

3 Select this unit in the list.

“YAS-209 Yamaha” is displayed in the list.

4 Play content with audio on the Bluetooth device.

The unit will begin playing audio from the Bluetooth device.

Streaming services

Audio content distributed by various streaming services over the Internet can be played via the unit. Use the Sound Bar Controller app (p. 14) to select content to play from a streaming service. See the Sound Bar Controller app for details.

See the product information page on the Yamaha website regarding which streaming services are currently supported by this unit.

■ NOTE

- A subscription may be required to listen to streaming services via this unit. For information on a particular streaming service, visit that service's website.
- Service is limited to certain areas.
- Services supported by the unit may not be available in some regions in which the unit is sold.
- Services may change or be discontinued without notice. Please note that Yamaha Corporation is in no way responsible for, and will not be held liable for, streaming services or issues arising from their use.

Operating the unit using voice commands (Amazon Alexa)

You can talk to Amazon Alexa on your unit. With Alexa, you can ask to play music, hear the news, check weather, control smart home devices, and more.

An Amazon account is required to use Amazon Alexa and the unit must be connected to a network. Use the Sound Bar Controller app to enter your Amazon account information and log into the service.

Alexa can perform the following operations with the proper voice commands.

- Switching input sources
- Adjusting (muting) the volume
- Selecting and listening to streaming services
See the product information page on the Yamaha website regarding which streaming services are currently supported by this unit.

■ NOTE

- Service is limited to certain areas.
- Services supported by the unit may not be available in some regions in which the unit is sold.
- See the product information page on the Yamaha website for the latest information.
- A subscription may be required to listen to Amazon Music or Amazon Kindle on this unit. For more information, visit the Amazon website.
- For information on other streaming services, visit the websites of those service providers.
- A smart hub (sold separately) may be required to connect smart home devices that will be controlled via the unit.

For example, just ask:

Adjust the volume

- “Alexa, turn up the volume.”
- “Alexa, turn down the volume.”

Switch input sources

- “Alexa, switch the input source to HDMI.”

Listen to streaming content from Amazon Music

- “Alexa, play some jazz music.”

Operate playback

- “Alexa, play next song.”
- “Alexa, stop the music.”
- “Alexa, what is this song?”

Check the weather

- “Alexa, what’s the weather?”

Set a timer

- “Alexa, set a timer for 10 minutes.”

YAMAHA CORPORATION

10-1 Nakazawa-cho, Naka-ku, Hamamatsu, 430-8650 Japan

Yamaha Global Site
<https://www.yamaha.com/>

Yamaha Downloads
<https://download.yamaha.com/>

Manual Development Group
© 2019 Yamaha Corporation

Published 05/2019 KSOD-A0

VQX1A2120Z

URAB