

# EVC Compact Front-Loaded Loudspeakers

---

en | Installation manual

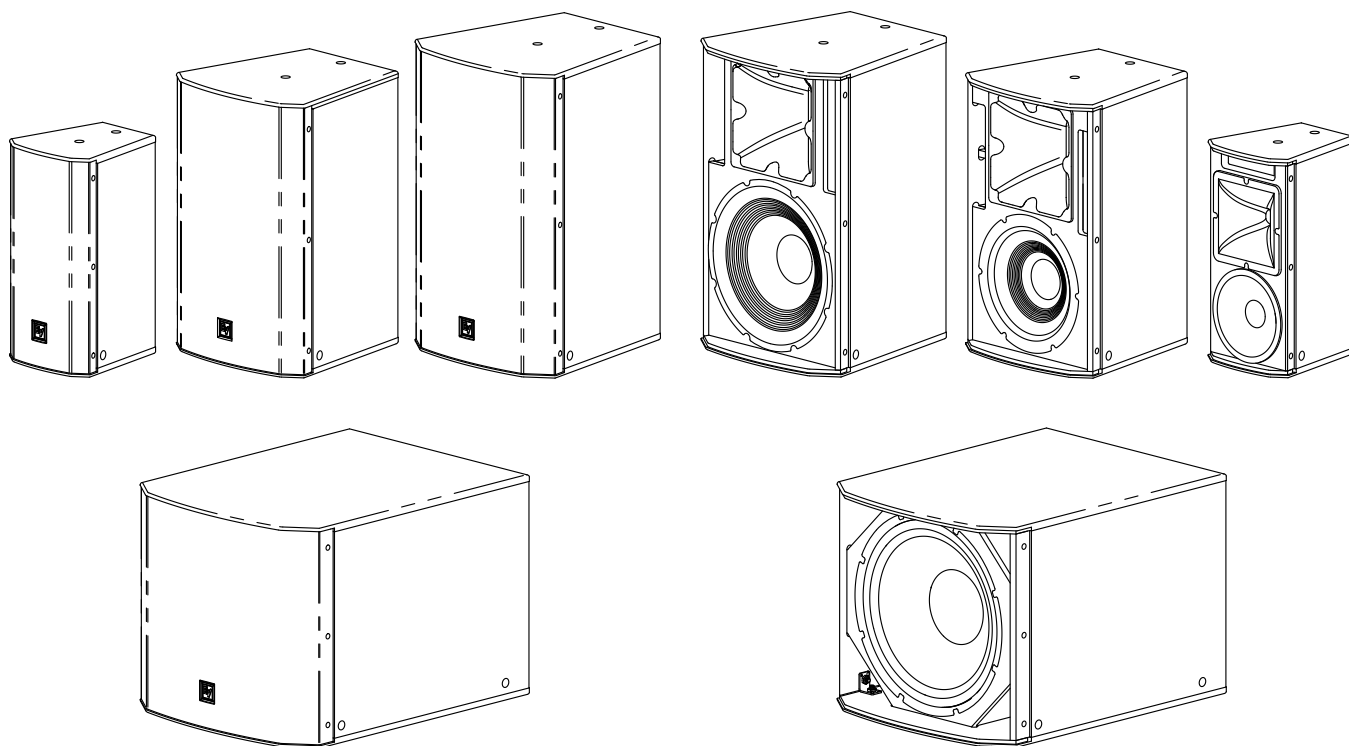



## Table of contents

<b>1</b>	<b>Safety</b>	<b>4</b>
1.1	Important safety instructions	4
1.2	Suspension	4
1.3	Precautions	5
1.4	Notices	5
<b>2</b>	<b>Short information</b>	<b>6</b>
<b>3</b>	<b>Introduction</b>	<b>7</b>
<b>4</b>	<b>Installation</b>	<b>9</b>
4.1	Tools list	9
4.2	General aiming and placement guidelines	9
4.3	Preparing the EVC loudspeakers for installation	9
4.3.1	Unpacking and inspection	9
4.3.2	Scope of delivery	9
4.3.3	Recommended pre-installation procedures	9
4.4	Rotation of high-frequency waveguides	10
4.5	Working with mounting accessories	11
4.5.1	Mounting with a U-bracket	12
4.5.2	Mounting with a pivoting wall bracket	13
4.5.3	Suspending an EVC loudspeaker using M10 suspension points	14
<b>5</b>	<b>Rigging strength ratings and safety factors</b>	<b>16</b>
<b>6</b>	<b>Electrical connection</b>	<b>19</b>
6.1	Low impedance connection	19
<b>7</b>	<b>Technical data</b>	<b>21</b>
7.1	EVC-1082-96 8" speaker 90x60	21
7.2	EVC-1082-00 8" speaker 100x100	23
7.3	EVC-1122-64 12" speaker 60x45	25
7.4	EVC-1122-95 12" speaker 90x55	27
7.5	EVC-1152-64 15" speaker 60x45	29
7.6	EVC-1152-95 15" speaker 90x55	31
7.7	EVC-1181S 18" subwoofer	33
<b>8</b>	<b>Accessories (optional)</b>	<b>35</b>
8.1	Installation of TK-150 transformer for passive crossovers	35
8.2	Input panel covers	38
<b>9</b>	<b>References</b>	<b>39</b>
9.1	Rigging (printed)	39
9.2	Mechanical engineering (printed)	39
9.3	Rigging (websites)	39

## 1 Safety

### 1.1 Important safety instructions

1. Read these instructions.
2. Keep these instructions.
3. Heed all warnings.
4. Follow all instructions.
5. Clean only with a dry cloth.
6. Do not install near any heat sources such as radiators, heat registers, stoves, or other apparatus (including amplifiers) that produce heat.

### 1.2 Suspension

---

#### **Warning!**



Suspending any object is potentially dangerous and should only be attempted by individuals who have a thorough knowledge of the techniques and regulations of suspending objects overhead. Electro-Voice strongly recommends that loudspeakers be suspended taking into account all current national, federal, state, and local laws and regulations. It is the responsibility of the installer to ensure all loudspeakers are safely installed in accordance with all such requirements. When loudspeakers are suspended, Electro-Voice strongly recommends the system be inspected at least once per year or as laws and regulations require. If any sign of weakness or damage is detected, remedial action should be taken immediately. The user is responsible for making sure the wall, ceiling, or structure is capable of supporting all objects suspended overhead. Any hardware used to suspend a loudspeaker not associated with Electro-Voice is the responsibility of others.

---

#### **Caution!**



**It is the installer's responsibility to determine and use the proper mounting hardware for the wall construction type.**

Disregarding this caution could result in damage to the product and personal injuries may occur.



---

#### **Redundant seismic safety cable**

As an added safety measure, when the loudspeaker is suspended or mounted, the user should connect an unused rigging point to a solid structural point using an appropriate safety cable. The cable should have a small amount of slack, but no more than  $\frac{3}{4}$  inch.

## 1.3

### Precautions

	These Electro-Voice loudspeakers were designed for use in an environment with ambient temperatures between -20°C (-4°F) and +50°C (122°F).
	These Electro-Voice loudspeakers are not rated for continuous outdoor conditions. However, they may be exposed to occasional short-term rain, water, or high humidity.
	Electro-Voice loudspeakers are easily capable of generating sound pressure levels sufficient to cause permanent hearing damage to anyone within normal coverage distance. Caution should be taken to avoid prolonged exposure to sound pressure levels exceeding 90 dB.

## 1.4



### Notices

#### Old electrical and electronic appliances

Electrical or electronic devices that are no longer serviceable must be collected separately and sent for environmentally compatible recycling (in accordance with the European Waste Electrical and Electronic Equipment Directive).

To dispose of old electrical or electronic devices, you should use the return and collection systems put in place in the country concerned.

#### Copyright and disclaimer

All rights reserved. No part of this document may be reproduced or transmitted in any form by any means, electronic, mechanical, photocopying, recording, or otherwise, without the prior written permission of the publisher. For information on getting permission for reprints and excerpts, contact Electro-Voice.

All content including specifications, data, and illustrations in this manual are subject to change without prior notice.

## 2

### Short information

The following table lists products in a family, with CTN (Commercial Type Number) and identifying product name DESCRIPTION.

CTN	DESCRIPTION
EVC-1082-96B	8" speaker, 90x60 indoor, black
EVC-1082-96W	8" speaker, 90x60 indoor, white
EVC-1082-96PIB	8" speaker, 90x60 weatherized, black
EVC-1082-96PIW	8" speaker, 90x60 weatherized, white
EVC-1082-00B	8" speaker, 100x100 indoor, black
EVC-1082-00W	8" speaker, 100x100 indoor, white
EVC-1082-00PIB	8" speaker, 100x100 weatherized, black
EVC-1082-00PIW	8" speaker, 100x100 weatherized, white
EVC-1122-64B	12" speaker, 60x45 indoor, black
EVC-1122-64W	12" speaker, 60x45 indoor, white
EVC-1122-64PIB	12" speaker, 60x45 weatherized, black
EVC-1122-64PIW	12" speaker, 60x45 weatherized, white
EVC-1122-95B	12" speaker, 90x55 indoor, black
EVC-1122-95W	12" speaker, 90x55 indoor, white
EVC-1122-95PIB	12" speaker, 90x55 weatherized, black
EVC-1122-95PIW	12" speaker, 90x55 weatherized, white
EVC-1152-64B	15" speaker, 60x45 indoor, black
EVC-1152-64W	15" speaker, 60x45 indoor, white
EVC-1152-64PIB	15" speaker, 60x45 weatherized, black
EVC-1152-64PIW	15" speaker, 60x45 weatherized, white
EVC-1152-95B	15" speaker, 90x55 indoor, black
EVC-1152-95W	15" speaker, 90x55 indoor, white
EVC-1152-95PIB	15" speaker, 90x55 weatherized, black
EVC-1152-95PIW	15" speaker, 90x55 weatherized, white
EVC-1181S-B	18" subwoofer indoor, black
EVC-1181S-W	18" subwoofer indoor, white
EVC-1181S-PIB	18" subwoofer weatherized, black
EVC-1181S-PIW	18" subwoofer weatherized, white

## 3 Introduction

EVC loudspeakers from Electro-Voice include five basic models. Three of them are two-way trapezoidal loudspeaker systems that can be used in a wide variety of applications where wide bandwidth, vertical and horizontal directivity control, and high efficiency are required in a compact, cost-effective package. The EVC Variable Intensity model is a two-way design with a unique compound waveguide that can evenly cover a defined rectangular audience area with almost no variation in sound quality and minimal change in level. The 18" subwoofer will complement any of the full-range systems. EVC loudspeakers are voiced so that they can be seamlessly used in systems with other EV-Innovation models (EVF, EVH, and EVA).

The high frequency section of EVC loudspeakers comprises a single 1¼-inch pure titanium dome compression driver directly coupled to a rotatable constant directivity waveguide that delivers uniform pattern control and smooth, linear response. The low frequency section employs a high-output woofer that was developed using state-of-the-art, computer-aided optimization to provide low distortion, high efficiency, and maximum intelligibility at high sound pressure levels. The passive crossover implements an enhanced fourth-order design with slopes of greater than 24 dB per octave for smooth off-axis response and improved definition through the critical vocal range. The subwoofer requires an external high-pass filter or crossover; it is the only model without an internal passive filter network.

The EVC series is an extremely cost effective solution for many fixed-install applications. The enclosures are constructed of 15-mm plywood and finished with EVCoat for enhanced durability. The loudspeakers have been designed with multiple M10 rigging points as well as attachment points for an optional U-bracket or multi mount style pan/tilt wall mount. There are no bracket options for the subwoofer. All EVC loudspeakers accept wire gauges up to 10 AWG. The input panel also accepts optional covers with NL4-type connectors or weatherized gland-nuts.

For 70V/100V operation, the input panel has an internal landing pad for mounting EV's high-quality TK-150 audio transformer. When the transformer is installed, it engages EV's patented Automatic Saturation Compensation (ASC), which preserves low frequency performance while presenting a stable load to the amplifier - regardless of the number of speakers connected in parallel. As a result, EVC loudspeakers - including the subwoofers - sound virtually identical, whether they are used with a transformer or without.

### Numbering scheme

The numbering scheme for EVC models is similar to that of other EV-Innovation loudspeakers. It denotes the number and diameter of the woofers, the number of passbands, the coverage pattern, level of weatherization, and the enclosure color. EVC speakers are available in black or white and in your choice of robust EVCoat and partially weatherized versions. For example, the EVC-1082-96PIW employs a single eight-inch woofer in a two-way configuration with a 90° x 60° waveguide coverage pattern, and has a white, weatherized enclosure. Similarly, the EVC-1181S-B uses a single 18" woofer to cover a single passband. In other words, it is a subwoofer or low-frequency system in a black enclosure.

### Finishes and colors available

EVC loudspeakers are finished in tough EVCoat. In addition, PI versions are rated for indirect outdoor exposure in protected areas, such as under a roof overhang, and feature a stainless-steel grille backed with acoustically-transparent hydrophobic cloth and a water-tight dual-

## EVC Compact Front-Loaded Loudspeakers

---

gland-nut input-panel cover. External fasteners on PI systems are stainless steel. All EVC systems are available in black or white. Black is indicated by B at the very end of the model number and white is indicated by W.

To find current user documentation visit our product related information at [www.electrovoice.com](http://www.electrovoice.com).

### **See also**

- *Technical data, page 21*



## 4 Installation

### 4.1 Tools list

The tools required to prepare the system for installation are:

- 3/16-inch (5 mm) flat blade screwdriver
- 6 mm Allen wrench
- Phillips #2 screwdriver

### 4.2 General aiming and placement guidelines

Loudspeakers should be *pointed at the people* and away from reflective room surfaces. Since people are excellent absorbers of sound and room surfaces are often not, this practice ensures not only that the audience will perceive the high frequencies necessary for good voice and musical clarity, but also that acoustic reflections do not excessively degrade intelligibility. Loudspeakers for sound reinforcement are usually located above a stage or platform and aimed down and out into the audience. This minimizes the difference between the longest throws to the rear of a venue and the shortest throws to the front rows, promoting uniform coverage. Note that a typical portable loudspeaker on a short, 6-foot stand cannot duplicate such uniformity since the distant seats are so much farther away than the front rows. The direct sound from a loudspeaker drops 6 dB every time the distance from it doubles, according to the formula:

$$\text{Level loss (dB)} = 20\log_{10} (\text{closest distance}/\text{farthest distance}).$$

### 4.3 Preparing the EVC loudspeakers for installation

#### 4.3.1 Unpacking and inspection

Carefully open the packaging and take out the loudspeaker. Inspect the loudspeaker's enclosure for any damage that might have happened during transportation. Each loudspeaker is examined and tested in detail before leaving the manufacturing site. Please inform the transport company immediately if the loudspeaker shows any damage. Being the addressee, you are the only person who can claim damages in transit. Keep the cardboard box and all packaging materials for inspection by the transport company.

Keeping the cardboard box including all packing materials is also recommended, even if the loudspeaker shows no external damage.

When shipping the loudspeaker, make sure to always use its original box and packaging materials. By packing the loudspeaker exactly as it was packed by the manufacturer, you will guarantee optimum protection from transport damage.

#### 4.3.2 Scope of delivery

Keep the original invoice that states the purchase/delivery date in a safe place.

#### 4.3.3 Recommended pre-installation procedures

For any sound system, certain checks made at the installer's place of business can prevent expensive on-site delays. EV recommends that you take the following steps:

1. Unpack all loudspeakers in the shop.
2. Check for proper model numbers.
3. Check the overall condition of the loudspeakers.
4. Check for continuity at the loudspeaker inputs.

## EVC Compact Front-Loaded Loudspeakers

Once you are on site and the loudspeakers are connected, it is a good idea to check again for continuity at the power-amplifier end of each cable run.

### 4.4

#### Rotation of high-frequency waveguides

EV loudspeakers are shipped with the wider waveguide pattern angle in the horizontal orientation when the speaker is upright. If desired, the waveguide can be rotated so that the wider pattern angle is in the vertical orientation. All high-frequency waveguides are labeled with their horizontal and vertical coverage angles, so you can easily identify the current orientation.

##### Tools required:

- Phillips #2 screwdriver

To **rotate the high-frequency waveguide**, do the following:

1. Remove the **three screws** on each side of the grille.

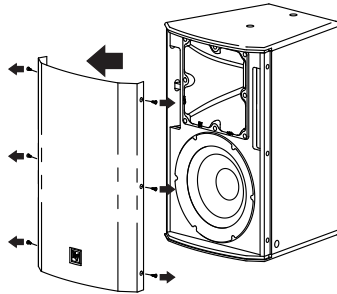

2. Pop the **grille** out.
3. Remove the **eight screws** holding the compression-driver/waveguide assembly.

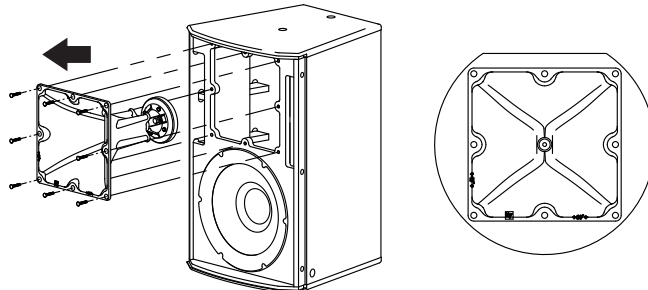

4. Rotate the **waveguide assembly** 90°.

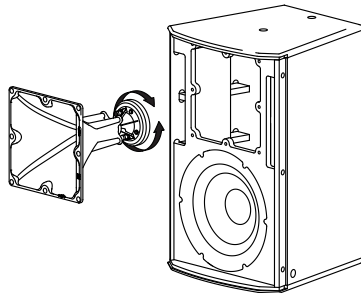

5. Reinstall the **waveguide assembly**.

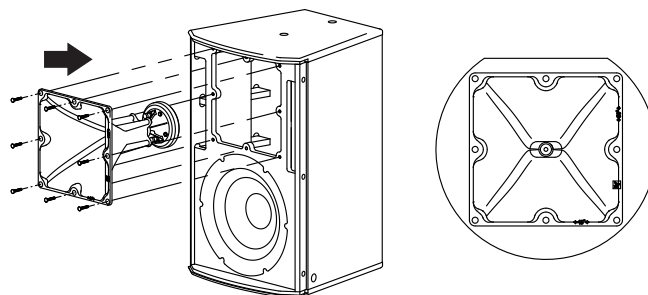

6. Reinstall the **grille**.

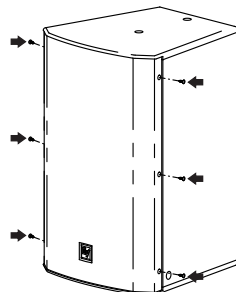

## 4.5 Working with mounting accessories



### Warning!

Suspending any object is potentially dangerous and should only be attempted by individuals who have a thorough knowledge of the techniques and regulations of suspending objects overhead. Electro-Voice strongly recommends that loudspeakers be suspended taking into account all current national, federal, state, and local laws and regulations. It is the responsibility of the installer to ensure all loudspeakers are safely installed in accordance with all such requirements. When loudspeakers are suspended, Electro-Voice strongly recommends the system be inspected at least once per year or as laws and regulations require. If any sign of weakness or damage is detected, remedial action should be taken immediately. The user is responsible for making sure the wall, ceiling, or structure is capable of supporting all objects suspended overhead. Any hardware used to suspend a loudspeaker not associated with Electro-Voice is the responsibility of others.



### Caution!

**It is the installer's responsibility to determine and use the proper mounting hardware for the wall construction type.**

Disregarding this caution could result in damage to the product and personal injuries may occur.

### Redundant seismic safety cable

As an added safety measure, when the loudspeaker is suspended or mounted, the user should connect an unused rigging point to a solid structural point using an appropriate safety cable. The cable should have a small amount of slack, but no more than  $\frac{3}{4}$  inch.

# EVC Compact Front-Loaded Loudspeakers

## 4.5.1 Mounting with a U-bracket

There are two U-Bracket models (EVC-UB1 and EVC-UB2) for mounting EVC full-range loudspeakers on a wall or ceiling.

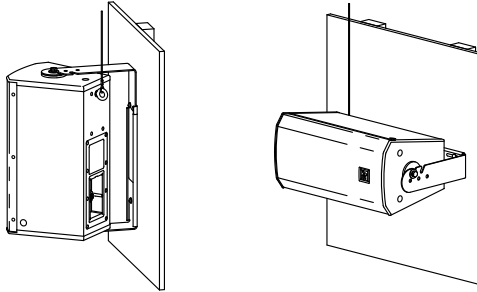

Figure 4.1: EVC U-bracket installed vertically or horizontally

EVC U-Bracket	EVC loudspeaker models
<p>EVC-UB1 is an optional U-Bracket kit for mounting a single EVC-1082 system to a wall or ceiling.</p> <p>Available in black or white:</p> <ul style="list-style-type: none"> <li>▪ EVC-UB1-BLK</li> <li>▪ EVC-UB1-WHT</li> </ul>	<p>The EVC-UB1 fits EVC-1082 models:</p> <p>EVC-1082-96B                      EVC-1082-96W                      EVC-1082-96PIB                      EVC-1082-96PIW                      EVC-1082-00B                      EVC-1082-00W                      EVC-1082-00PIB                      EVC-1082-00PIW</p>
<p>EVC-UB2 is an optional U Bracket kit for mounting a single EVC-1122 or EVC-1152 system to a wall or ceiling.</p> <p>Available in black or white:</p> <ul style="list-style-type: none"> <li>▪ EVC-UB2-BLK</li> <li>▪ EVC-UB2-WHT</li> </ul>	<p>The EVC-UB2 fits all trapezoid-shaped EVC-1122 and EVC-1152 models:</p> <p>EVC-1122-64B                      EVC-1122-64W                      EVC-1122-64PIB                      EVC-1122-64PIW                      EVC-1122-95B                      EVC-1122-95W                      EVC-1122-95PIB                      EVC-1122-95PIW                      EVC-1152-64B                      EVC-1152-64W                      EVC-1152-64PIB                      EVC-1152-64PIW                      EVC-1152-95B                      EVC-1152-95W                      EVC-1152-95PIB                      EVC-1152-95PIW</p>

Table 4.1: EVC U-Bracket mounting models

For more information, see EVC-UB1 and EVC-UB2 Adjustable U-Mount Mounting Bracket Installation Instructions (F.01U.349.929).

## 4.5.2 Mounting with a pivoting wall bracket

The most flexible mounting accessory for EVC loudspeakers is the wall bracket, which can be adjusted for a wide range of pan/tilt positioning angles. With the wall bracket, you will be able to achieve more precise aiming than is possible with the U-Bracket. The wall bracket will fit any of the trapezoidal loudspeakers; there is no wall bracket for the VI or subwoofer models.

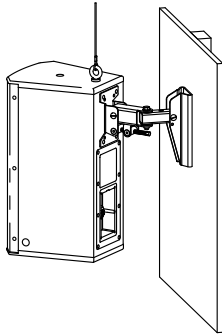

Figure 4.2: EVC-WB multi mount wall bracket

EVC multi mount wall bracket	EVC loudspeaker models
<p>The EVC-WB is a pan/tilt Omnimount-style wall mount bracket for mounting EVC-1082, EVC-1122, or EVC-1152 loudspeakers.</p> <p>Available in black or white:            EVC-WB-BLK            EVC-WB-WHT</p>	<p>EVC-1082-96B            EVC-1082-96W            EVC-1082-96PIB            EVC-1082-96PIW            EVC-1082-00B            EVC-1082-00W            EVC-1082-00PIB            EVC-1082-00PIW            EVC-1122-64B            EVC-1122-64W            EVC-1122-64PIB            EVC-1122-64PIW            EVC-1122-95B            EVC-1122-95W            EVC-1122-95PIB            EVC-1122-95PIW            EVC-1152-64B            EVC-1152-64W            EVC-1152-64PIB            EVC-1152-64PIW            EVC-1152-95B            EVC-1152-95W            EVC-1152-95PIB            EVC-1152-95PIW</p>

Table 4.2: EVC Multi Mount Wall Mount Bracket mounting models

For more information, see EVC-WB Multi Mount Wall Mount Bracket Installation Instructions (F.01U.349.932).

## 4.5.3

### Suspending an EVC loudspeaker using M10 suspension points

EVC loudspeakers must be hung in an inverted orientation when suspended from the insert points. The trapezoidal enclosures require attachment to three points. The subwoofer requires attachment at four points. It is not possible to suspend EVC speakers horizontally. A safety cable should always be attached to one of the suspension points.

EVC loudspeakers are designed to be installed individually. There are no factory-approved accessories for creating clusters by connecting an EVC loudspeaker to any other loudspeaker.

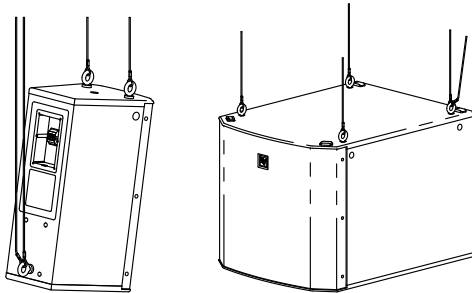

Figure 4.3: Suspending EVC systems, including a safety cable

#### Eyebolt accessory kits

EVC loudspeakers do not ship with eyebolts. To suspend the speaker, it is necessary to order one of the accessory eyebolt kits (sold separately).

- EBK-M10-3PACK: optional eyebolt kit, consisting of three M10 shoulder eyebolts and three fender washers, used when eyebolts are needed to suspend any of the full-range EVC loudspeakers. For more information see, EBK-M10 Eyebolt Attachment Kit Installation Instructions (F.01U.303.870).
- EBK-M10-4PACK: optional eyebolt kit, consisting of four M10 shoulder eyebolts and four fender washers, used when eyebolts are needed to suspend any of the full-range EVC loudspeakers or the EVC-1181S subwoofer. For more information see, EBM-M10-4PACK M10 Eyebolt Attachment Kit Installation Instructions (F.01U.349.930).

#### Installing the eyebolts



#### Caution!

No eyebolt should be mounted in the sides of an EVC enclosure in order to suspend a system. Doing so may result in damage to the enclosure, leading to installation failure, and personal injury.

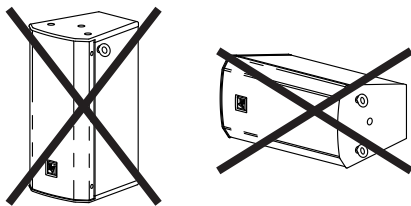
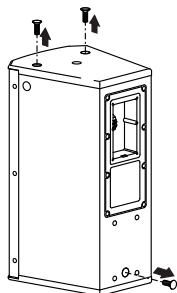

Figure 4.4: Eyebolts installed incorrectly in the sides of an enclosure in order to suspend it from above

All hardware supplied by the user must be rated for overhead lifting to suspend the loudspeaker system.

To **install the eyebolts**, do the following:

1. Remove the **M10 flat-head bolts** from the fly points you will use on the enclosure.



2. Screw the lifting **eyebolt with fender washer** into the threaded attachment point until the fender washer makes contact with the enclosure.

*Never install the eyebolt without the washer included with the eyebolt kit.*

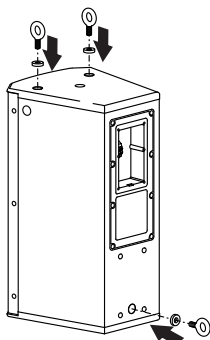

3. Finger tighten the **eyebolt** until the correct alignment position is obtained.  
*A maximum of one complete turn.*
4. Install a **safety cable**.

### Eyebolts orientated in the plane of pull



#### Caution!

Eyebolts must be fully seated and oriented in the plane of pull. Always use the fender washer included with the eyebolt kit to distribute the load on the enclosure.

Excessive tightening of the eyebolt with a wrench, screwdriver or other tool, can result in a system failure and possible injury.

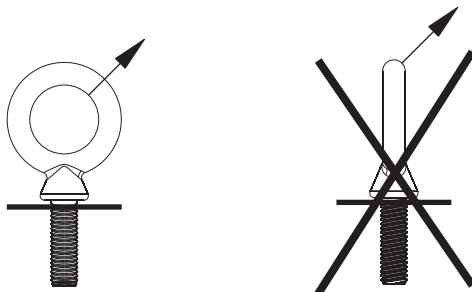

**Figure 4.5: Fully seated eyebolts with washers, with correct orientation in the plane of pull (Correct; left, Incorrect; right)**

### 5 Rigging strength ratings and safety factors

#### **Working load limit and safety-factor definitions**

The structural ratings for all EVC rigging components and loudspeaker systems are based on test results in which parts were stressed to failure. Manufacturers typically present the structural-strength ratings of mechanical components or systems as either the Working Load Limit (WLL) or the ultimate-break strength. Electro-Voice chooses to present the structural-load ratings of loudspeaker systems as the WLL. The WLL rating represents the maximum load that should ever be applied to a mechanical component or system.



#### **Warning!**

Never exceed the limitations or maximum recommended working load for Electro-Voice loudspeakers.

Disregarding this warning could result in serious injury or death.

---

The WLL for the rigging components and loudspeaker systems described in this manual is calculated with a 10:1 safety factor, which exceeds the minimum 8:1 safety factor normally specified by Electro-Voice. The safety factor is defined as the ratio of the ultimate-break strength divided by the WLL, where the ultimate-break strength represents the force at which a part will structurally fail. For example, if a part has a WLL of 100 lb (45.4 kg), it would not structurally fail until a force of at least 1,000 lb (453.6 kg) was applied, based on a 10:1 safety factor. However, the user should never apply a load to that part that exceeds 100 lb (45.4 kg). The safety factor provides a margin of safety above the WLL to accommodate normal dynamic loading and normal wear.

#### **Cautions for working load limits and safety factors**

The WLL defined by the manufacturer of any rigging component should never be exceeded. Other manufacturers of rigging components may base their WLL on safety factors other than 10:1. For example, 5:1 safety factors are fairly common among rigging manufacturers because many regulatory agencies call for a minimum safety factor of 5:1.

When an EV loudspeaker system is installed where local regulations only require a safety factor of 5:1, Electro-Voice insists that the WLL of the loudspeaker rigging never be exceeded and that an 10:1 safety factor be maintained.

The user is cautioned that some local regulations may require safety factors higher than 10:1. In those circumstances, Electro-Voice insists that the user maintain the higher safety factor as required by the local regulations throughout the entire loudspeaker installation. It is the responsibility of the user to make sure that any loudspeaker installation meets all applicable local, state or federal safety regulations.

#### **Recommended practice for eyebolts**

Eyebolts can be used to suspend individual loudspeakers when attached through the integral M10 attachment points. It is a good idea to orient the suspending cable so that it hangs within 30° of the straight-up position in the plane of pull (left illustration), and within 15° against the plane of pull (right illustration).



### Suspension line angle limits for individual eyebolts

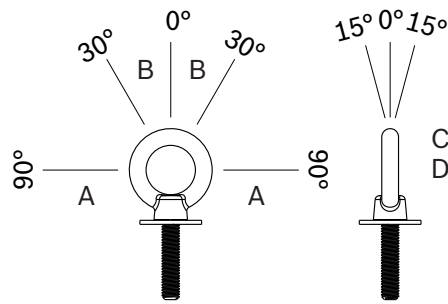

**Figure 5.1: Suspension line angle limits for individual eyebolts, both in plane of pull (left) and against plane of pull (right)**

- A Above 90° NOT TO BE USED
- B 0° to 30° recommended for main suspension line angle
- C ±15° for all applications
- D Above 15° NOT TO BE USED

### Suspension line angles

Refer to *Working load limit for M10 eyebolts and EVC loudspeakers, page 17* and *Suspension line angle limits for individual eyebolts, page 17* for specific eyebolt angle and weight limitations when using eyebolt suspension. These limits are not to be exceeded under any circumstances. If a safety factor higher than 10:1 is required, the angle limits for each eyebolt may actually decrease to a number less than what is shown in *Suspension line angle limits for individual eyebolts, page 17*.

### Working load limit for M10 eyebolts and EVC loudspeakers

Model	WLL Each Point (10:1)	WLL Each Speaker (10:1)
EVC-1082	30 lb	30 lb
EVC-1122-64 or EVC-1122-95	55 lb	55 lb
EVC-1122-VI	55 lb	55 lb
EVC-1152	65 lb	65 lb
EVC-1181S	85 lb	85 lb

**Table 5.1: WLL for M10 eyebolts and EVC loudspeakers**

Always ensure that the suspension line is in the plane of the eyebolt, as shown in *Eyebolts orientated in the plane of pull, page 15*. Readjust the eyebolt during the installation if necessary to maintain this alignment.

# EVC Compact Front-Loaded Loudspeakers

## Eyebolt suspension-line angle limit

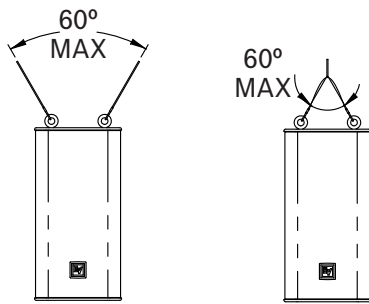

Figure 5.2: All-eyebolt suspension-line angle limit, independent (left) or bridled (right) suspension lines

## Left-to-right all-eyebolt suspension angles

The suspended all-eyebolt cluster must be perpendicular (plumb) to within  $\pm 5^\circ$ .

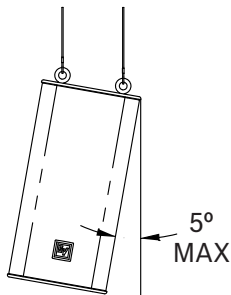

Figure 5.3: Left-to-right angle limits for an all-eyebolt suspension (visual angle shown exaggerated for illustration purposes)



## Notice!

The PI models need a minimum  $10^\circ$  downward tilt to minimize risk of water entering the enclosure.

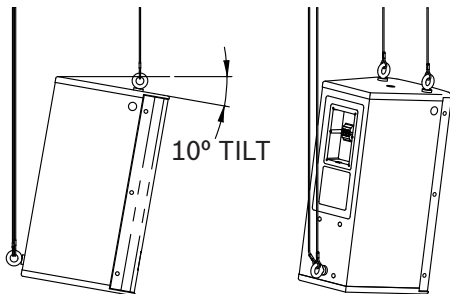

Figure 5.4: EVC PI models  $10^\circ$  minimum downward tilt

## See also

- *Rigging strength ratings and safety factors, page 16*
- *Rigging strength ratings and safety factors, page 17*
- *Suspending an EVC loudspeaker using M10 suspension points, page 15*
- *Rigging strength ratings and safety factors, page 18*
- *Rigging strength ratings and safety factors, page 17*

## 6 Electrical connection

### 6.1 Low impedance connection

All EVC full-range systems are passive, meaning that the internal crossover/equalizer network sends low frequencies to the woofer and high frequencies to the compression-driver/waveguide combination. In addition, the network tailors the frequency response and level of each individual driver so that the overall frequency response of the loudspeaker is essentially flat over its intended range of operation. There is no bi-amp option for EVC full-range loudspeakers.

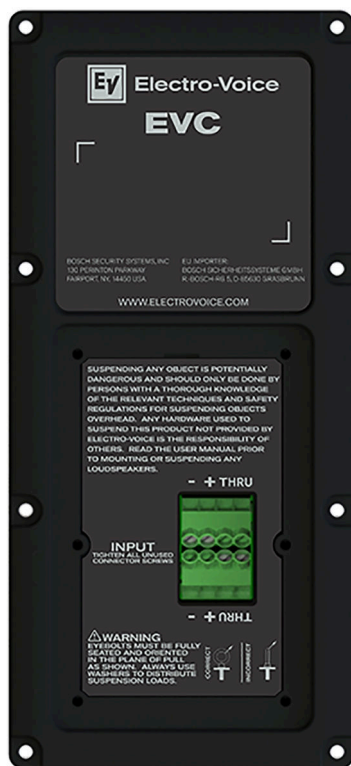

**Figure 6.1: EVC input panel**

The screw terminals on the input panel will accept wire gauges as large as AWG 10. There are two pairs of terminals labeled + and -. A speaker-level audio signal should be connected to one of these +/- pairs. The other +/- pair can be used to connect one or more additional loudspeakers in parallel, as long as the combined load impedance does not drop too low for the amplifier to operate reliably. When the TK-150 audio transformer is installed in an EVC loudspeaker, the ASC feature will automatically keep the impedance of each loudspeaker in a safe range. The two pairs of connections marked THRU are wired as pass-through connections for a separate audio signal.

#### Optional speaker processing

Once an EVC loudspeaker is installed in a venue a Digital Signal Processor (DSP) will typically be used to adjust the in-room frequency response. In addition, the DSP should be used to provide the high-pass filters recommended to protect EVC systems against overdrive at frequencies below their operating range. Failure to do so could damage the low-frequency drivers if the system is subjected to high-level signals below its operating range.

## EVC Compact Front-Loaded Loudspeakers

---

<b>Models</b>	<b>Recommended high-pass frequency (minimum)</b>
EVC-1082	50 Hz, 4 <sup>th</sup> -order high-pass (24dB/octave)
EVC-1122	45 Hz, 4 <sup>th</sup> -order high-pass (24dB/octave)
EVC-1152	40 Hz, 4 <sup>th</sup> -order high-pass (24dB/octave)
EVC-1181S	35 Hz, 4 <sup>th</sup> -order high-pass (24dB/octave)

**Table 6.1: Recommended high-pass filter frequencies for infrasonic protection of EVC systems**

The recommended high-pass filter can be implemented in a stand-alone DSP loudspeaker controller or in the processing section of a DSP-enabled amplifier. L Series and C Series amplifiers from Dynacord are recommended for use with EVC loudspeakers because they can also implement model-specific processing that optimizes loudspeaker performance. EVC loudspeaker settings can also be implemented in any IRIS-Net compatible digital signal processor.

## 7 Technical data

### 7.1 EVC-1082-96 8" speaker 90x60

Frequency response (-3 dB) <sup>1, 3</sup> :	75 Hz - 21 kHz	
Frequency range (-10 dB) <sup>1, 3</sup> :	55 Hz - 25 kHz	
Rotatable coverage:	90° x 60°	
Rec. high-pass frequency:	50 Hz	
Passive crossover frequency:	1.85 kHz	
Axial sensitivity <sup>1</sup> :	91 dB (1 W/1 m)	
Max. calculated SPL <sup>1</sup> :	120 dB	
Power handling <sup>2</sup> :	200 W (Continuous), 800 W (Peak)	
Nominal impedance:	8 Ω	
Minimum impedance:	6 Ω	
LF transducer:	EVS-2008	
HF transducer:	DH-2005	
Connectors:	Dual four-pin 10 AWG Phoenix/Euro Block screw-terminals	
Enclosure:	15-mm plywood with EVCoat	
Grille:	18 GA powder-coated steel with rotatable logo	PI version: 18 GA stainless steel with hydrophobic cloth
Environmental:	IEC 60529, IP44	PI version: IEC 60529, IP55
Suspension:	(8) M10 suspension points	
Color:	Black or white	
Dimensions (H x W x D):	492 mm x 248 mm x 277 mm (19.38 in x 9.76 in x 11.01 in)	
Net weight:	11.2 kg (24.8 lb)	
Shipping weight:	12.7 kg (28.0 lb)	

<sup>1</sup>Full-space measurement.

<sup>2</sup>EIA RS-426A, tested for eight hours.

<sup>3</sup>With recommended preset.

# EVC Compact Front-Loaded Loudspeakers

## Frequency response and impedance:

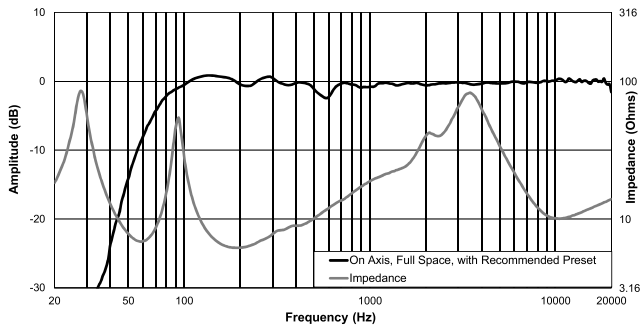

## Horizontal off-axis frequency response:

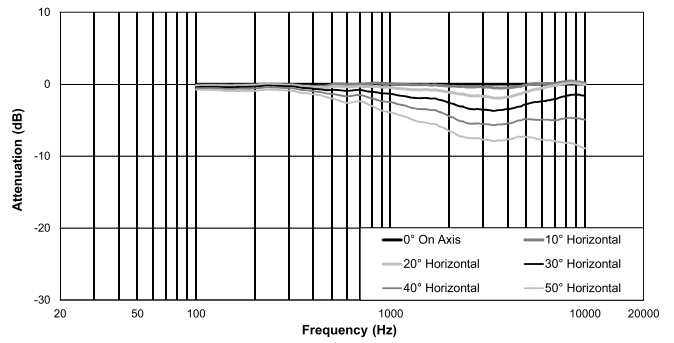

## Vertical off-axis frequency response (down):

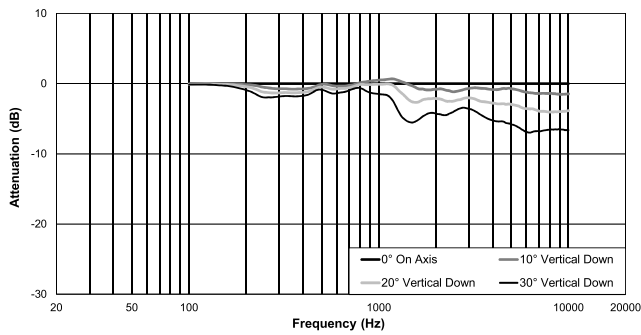

## Vertical off-axis frequency response (up):

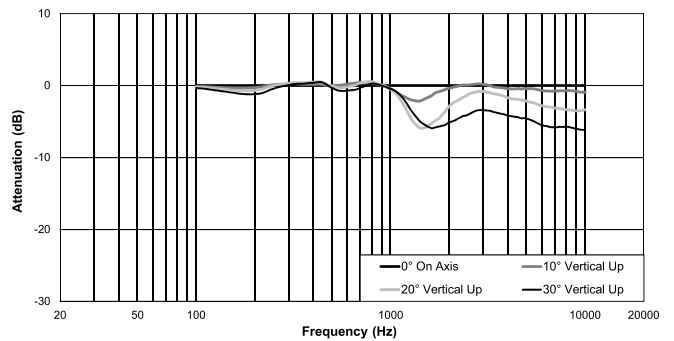

## Beamwidth:

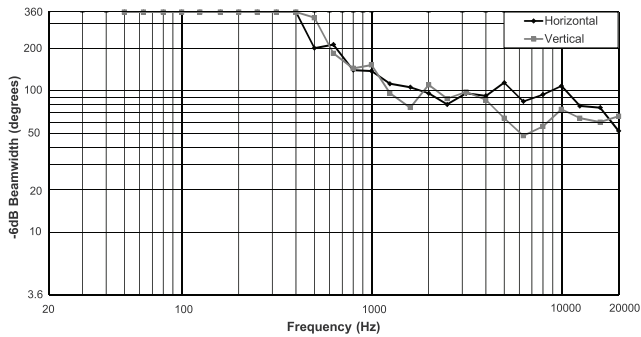

## Dimensions:

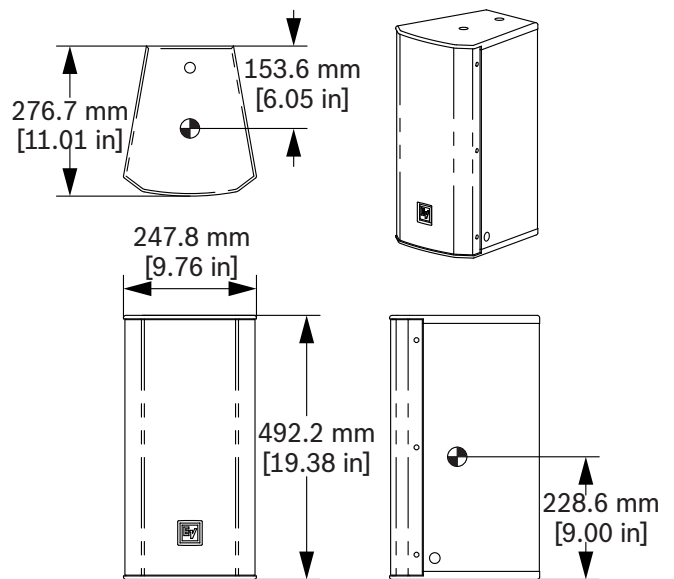

## 7.2

**EVC-1082-00 8" speaker 100x100**

Frequency response (-3 dB) <sup>1, 3</sup> :	75 Hz - 20 kHz	
Frequency range (-10 dB) <sup>1, 3</sup> :	55 Hz - 25 kHz	
Rotatable coverage:	100° x 100°	
Rec. high-pass frequency:	50 Hz	
Passive crossover frequency:	1.85 kHz	
Axial sensitivity <sup>1</sup> :	91 dB (1 W/1 m)	
Max. calculated SPL <sup>1</sup> :	120 dB	
Power handling <sup>2</sup> :	200 W (Continuous), 800 W (Peak)	
Nominal impedance:	8 Ω	
Minimum impedance:	6 Ω	
LF transducer:	EVS-2008	
HF transducer:	DH-2005	
Connectors:	Dual four-pin 10 AWG Phoenix/Euro Block screw-terminals	
Enclosure:	15-mm plywood with EVCoat	
Grille:	18 GA powder-coated steel with rotatable logo	PI version: 18 GA stainless steel with hydrophobic cloth
Environmental:	IEC 60529, IP44	PI version: IEC 60529, IP55
Suspension:	(8) M10 suspension points	
Color:	Black or white	
Dimensions (H x W x D):	492 mm x 248 mm x 277 mm (19.38 in x 9.76 in x 11.01 in)	
Net weight:	11.2 kg (24.8 lb)	
Shipping weight:	12.7 kg (28.0 lb)	

<sup>1</sup>Full-space measurement.

<sup>2</sup>EIA RS-426A, tested for eight hours.

<sup>3</sup>With recommended preset.

# EVC Compact Front-Loaded Loudspeakers

## Frequency response and impedance:

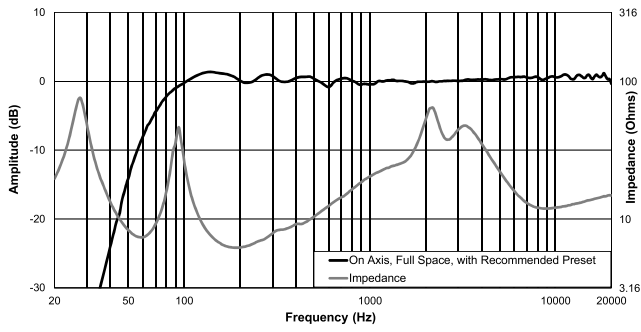

## Horizontal off-axis frequency response:

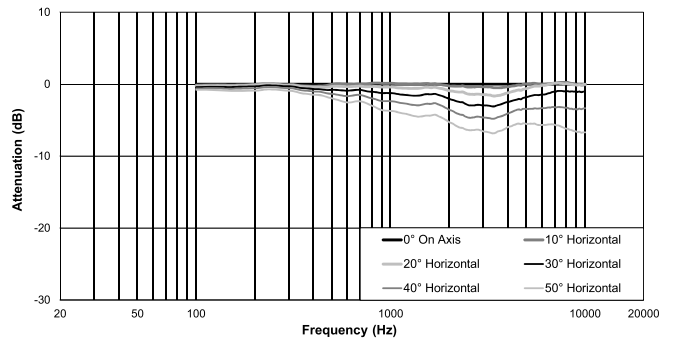

## Vertical off-axis frequency response (down):

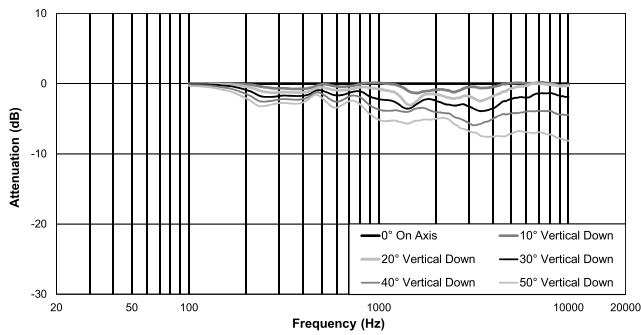

## Vertical off-axis frequency response (up):

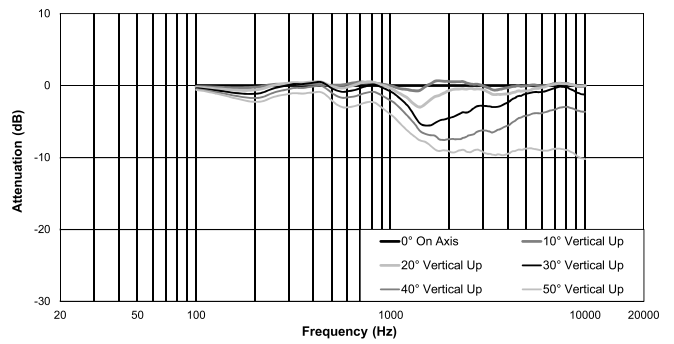

## Beamwidth:

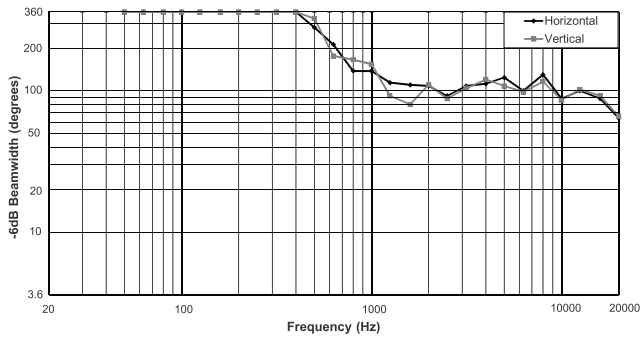

## Dimensions:

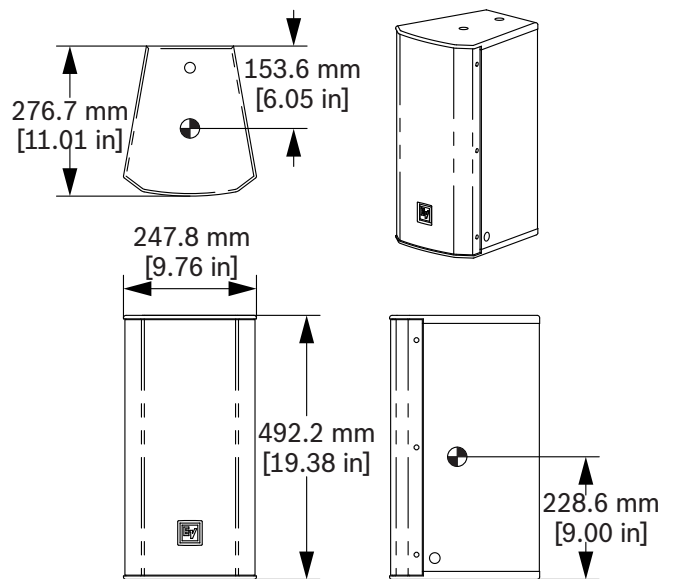



## 7.3

**EVC-1122-64 12" speaker 60x45**

Frequency response (-3 dB) <sup>1, 3</sup> :	70 Hz - 20 kHz	
Frequency range (-10 dB) <sup>1, 3</sup> :	50 Hz - 25 kHz	
Rotatable coverage:	60° x 45°	
Rec. high-pass frequency:	45 Hz	
Passive crossover frequency:	1.6 kHz	
Axial sensitivity <sup>1</sup> :	95 dB (1 W/1 m)	
Max. calculated SPL <sup>1</sup> :	126 dB	
Power handling <sup>2</sup> :	300 W (Continuous), 1200 W (Peak)	
Nominal impedance:	8 Ω	
Minimum impedance:	7 Ω	
LF transducer:	EVS-12M	
HF transducer:	DH-3	
Connectors:	Dual four-pin 10 AWG Phoenix/Euro Block screw-terminals	
Enclosure:	15-mm plywood with EVCoat	
Grille:	18 GA powder-coated steel with rotatable logo	PI version: 18 GA stainless steel with hydrophobic cloth
Environmental:	IEC 60529, IP44	PI version: IEC 60529, IP55
Suspension:	(8) M10 suspension points	
Color:	Black or white	
Dimensions (H x W x D):	616 mm x 395 mm x 401 mm (24.26 in x 15.56 in x 15.77 in)	
Net weight:	20.3 kg (44.7 lb)	
Shipping weight:	22.7 kg (50.0 lb)	

<sup>1</sup>Full-space measurement.

<sup>2</sup>EIA RS-426A, tested for eight hours.

<sup>3</sup>With recommended preset.

# EVC Compact Front-Loaded Loudspeakers

## Frequency response and impedance:

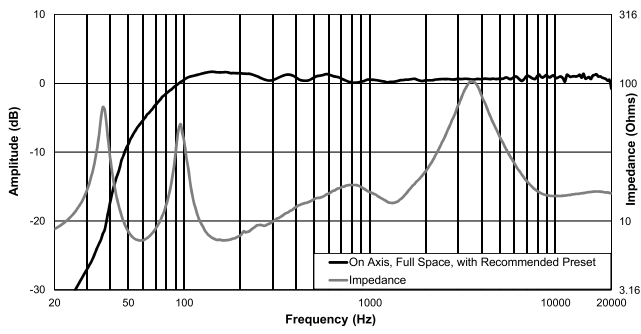

## Horizontal off-axis frequency response:

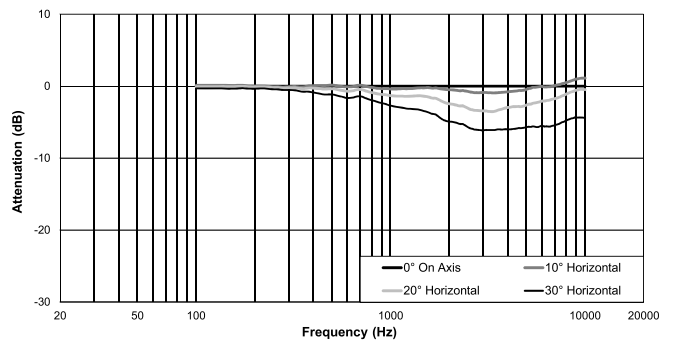

## Vertical off-axis frequency response (down):

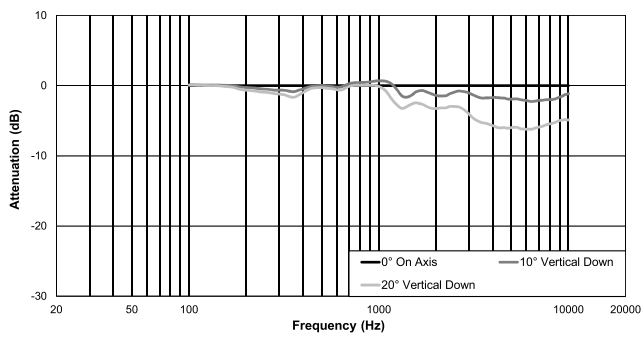

## Vertical off-axis frequency response (up):

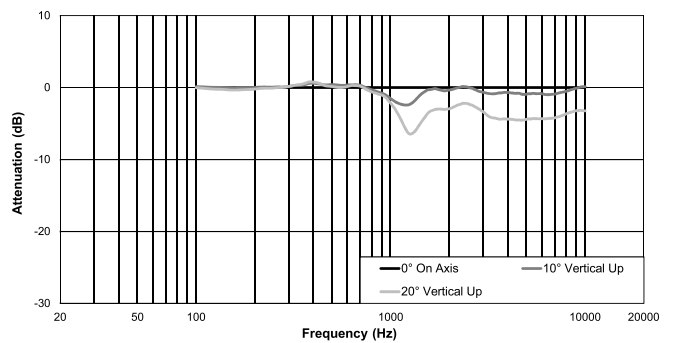

## Beamwidth:

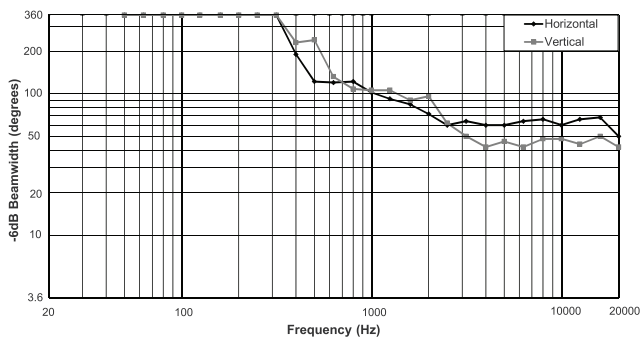

## Dimensions:

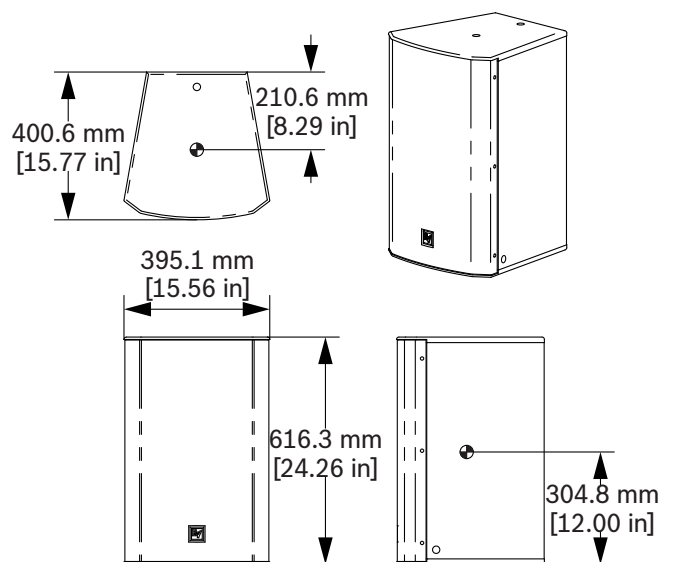

## 7.4 EVC-1122-95 12" speaker 90x55

Frequency response (-3 dB) <sup>1, 3</sup> :	70 Hz - 22 kHz	
Frequency range (-10 dB) <sup>1, 3</sup> :	50 Hz - 25 kHz	
Rotatable coverage:	90° x 55°	
Rec. high-pass frequency:	45 Hz	
Passive crossover frequency:	1.6 kHz	
Axial sensitivity <sup>1</sup> :	95 dB (1 W/1 m)	
Max. calculated SPL <sup>1</sup> :	126 dB	
Power handling <sup>2</sup> :	300 W (Continuous), 1200 W (Peak)	
Nominal impedance:	8 Ω	
Minimum impedance:	7 Ω	
LF transducer:	EVS-12M	
HF transducer:	DH-3	
Connectors:	Dual four-pin 10 AWG Phoenix/Euro Block screw-terminals	
Enclosure:	15-mm plywood with EVCoat	
Grille:	18 GA powder-coated steel with rotatable logo	PI version: 18 GA stainless steel with hydrophobic cloth
Environmental:	IEC 60529, IP44	PI version: IEC 60529, IP55
Suspension:	(8) M10 suspension points	
Color:	Black or white	
Dimensions (H x W x D):	616 mm x 395 mm x 401 mm (24.26 in x 15.56 in x 15.77 in)	
Net weight:	20.3 kg (44.7 lb)	
Shipping weight:	22.7 kg (50.0 lb)	

<sup>1</sup>Full-space measurement.

<sup>2</sup>EIA RS-426A, tested for eight hours.

<sup>3</sup>With recommended preset.

# EVC Compact Front-Loaded Loudspeakers

## Frequency response and impedance:

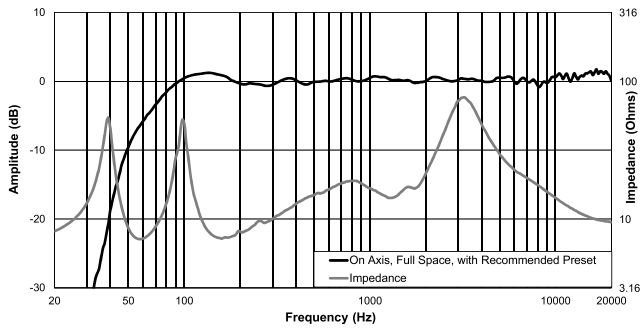

## Horizontal off-axis frequency response:

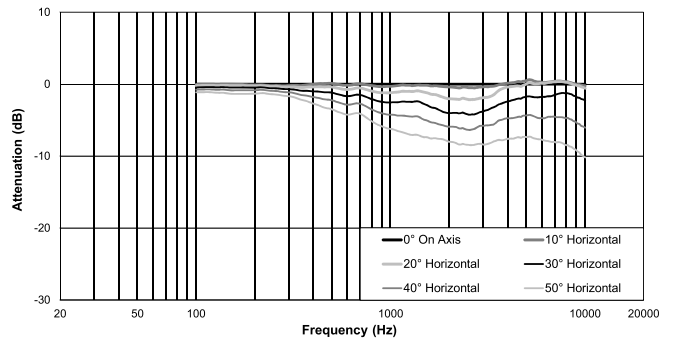

## Vertical off-axis frequency response (down):

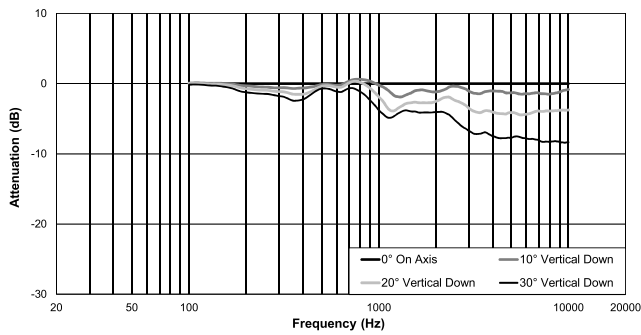

## Vertical off-axis frequency response (up):

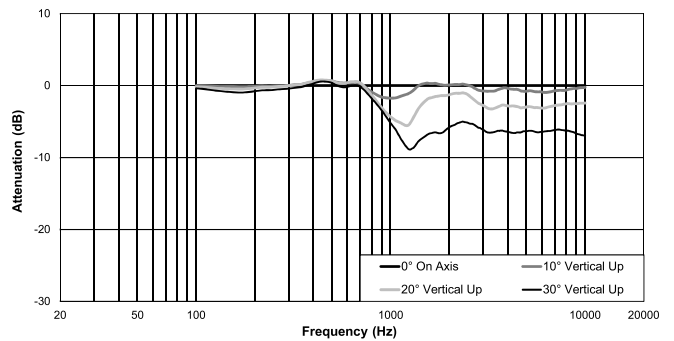

## Beamwidth:

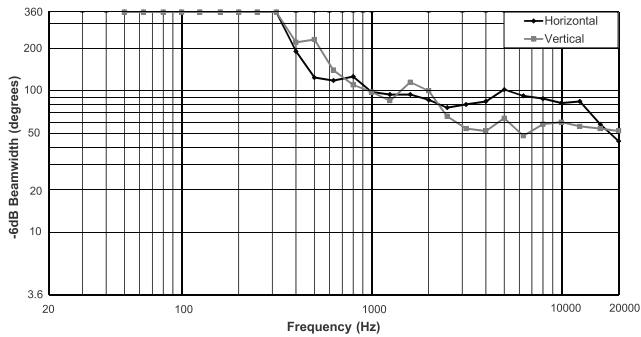

## Dimensions:

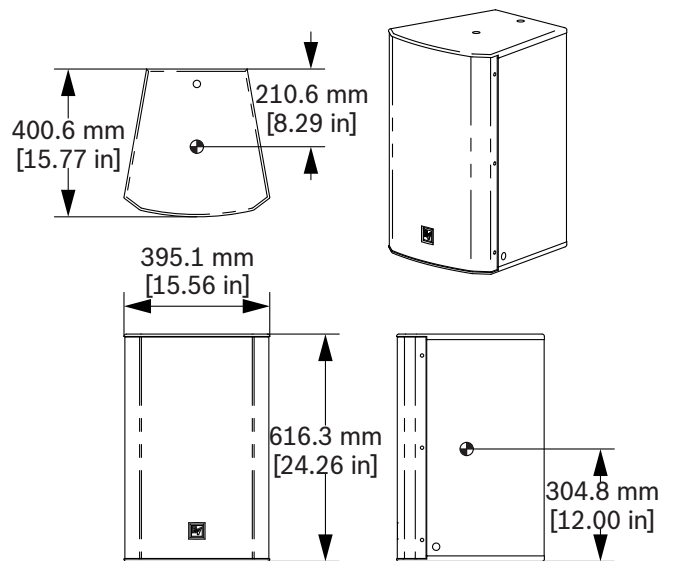

## 7.5 EVC-1152-64 15" speaker 60x45

Frequency response (-3 dB) <sup>1, 3</sup> :	70 Hz - 20 kHz	
Frequency range (-10 dB) <sup>1, 3</sup> :	50 Hz - 25 kHz	
Rotatable coverage:	60° x 45°	
Rec. high-pass frequency:	40 Hz	
Passive crossover frequency:	1.6 kHz	
Axial sensitivity <sup>1</sup> :	98 dB (1 W/1 m)	
Max. calculated SPL <sup>1</sup> :	129 dB	
Power handling <sup>2</sup> :	350 W (Continuous), 1400 W (Peak)	
Nominal impedance:	8 Ω	
Minimum impedance:	6.7 Ω	
LF transducer:	EVS-15M	
HF transducer:	DH-3	
Connectors:	Dual four-pin 10 AWG Phoenix/Euro Block screw-terminals	
Enclosure:	15-mm plywood with EVCoat	
Grille:	18 GA powder-coated steel with rotatable logo	PI version: 18 GA stainless steel with hydrophobic cloth
Environmental:	IEC 60529, IP44	PI version: IEC 60529, IP55
Suspension:	(8) M10 suspension points	
Color:	Black or white	
Dimensions (H x W x D):	684 mm x 433 mm x 451 mm (26.91 in x 17.05 in x 17.77 in)	
Net weight:	25.0 kg (55.1 lb)	
Shipping weight:	27.7 kg (61.0 lb)	

<sup>1</sup>Full-space measurement.

<sup>2</sup>EIA RS-426A, tested for eight hours.

<sup>3</sup>With recommended preset.

# EVC Compact Front-Loaded Loudspeakers

## Frequency response and impedance:

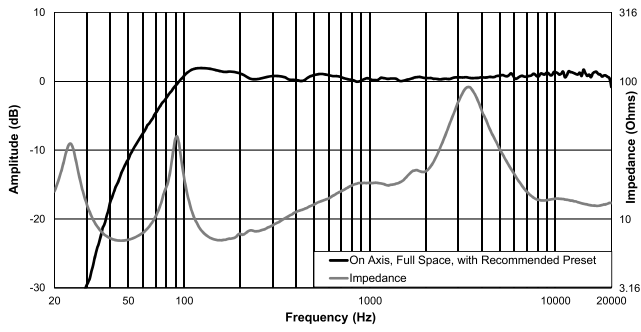

## Horizontal off-axis frequency response:

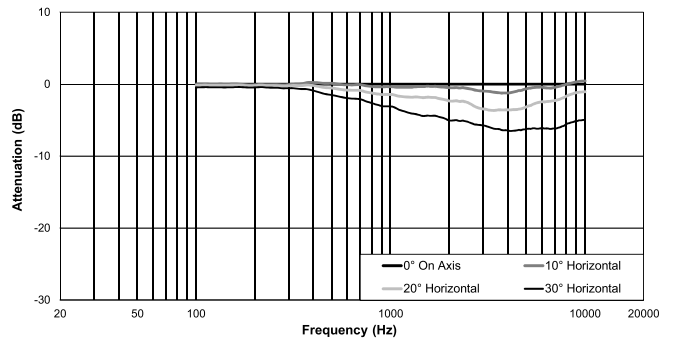

## Vertical off-axis frequency response (down):

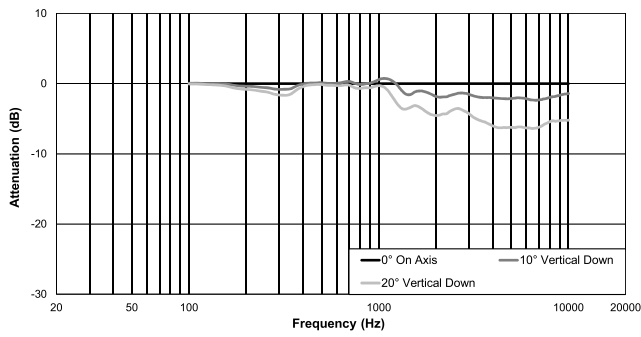

## Vertical off-axis frequency response (up):

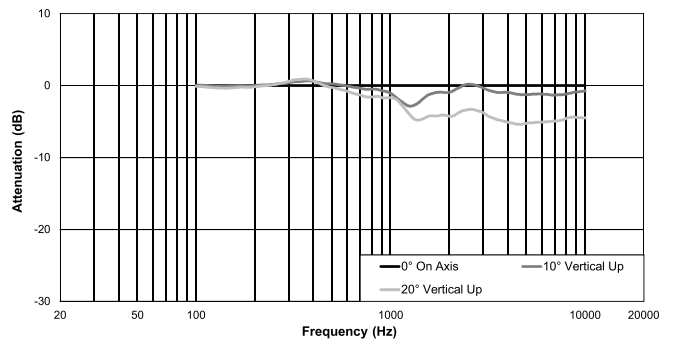

## Beamwidth:

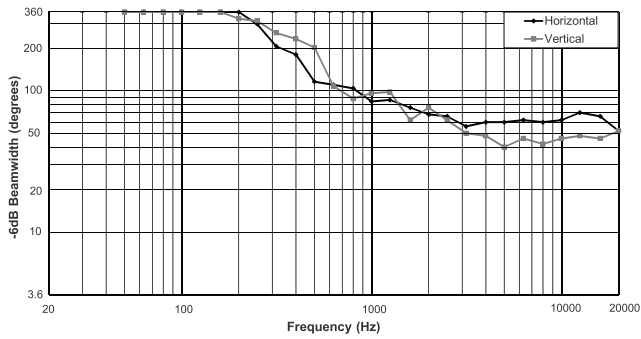

## Dimensions:

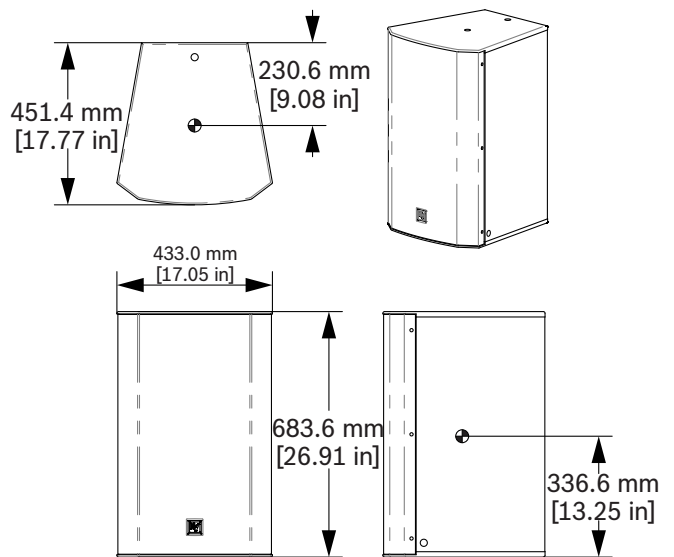

## 7.6

**EVC-1152-95 15" speaker 90x55**

Frequency response (-3 dB) <sup>1, 3</sup> :	70 Hz - 21 kHz	
Frequency range (-10 dB) <sup>1, 3</sup> :	50 Hz - 25 kHz	
Rotatable coverage:	90° x 55°	
Rec. high-pass frequency:	40 Hz	
Passive crossover frequency:	1.6 kHz	
Axial sensitivity <sup>1</sup> :	98 dB (1 W/1 m)	
Max. calculated SPL <sup>1</sup> :	129 dB	
Power handling <sup>2</sup> :	350 W (Continuous), 1400 W (Peak)	
Nominal impedance:	8 Ω	
Minimum impedance:	6.7 Ω	
LF transducer:	EVS-15M	
HF transducer:	DH-3	
Connectors:	Dual four-pin 10 AWG Phoenix/Euro Block screw-terminals	
Enclosure:	15-mm plywood with EVCoat	
Grille:	18 GA powder-coated steel with rotatable logo	PI version: 18 GA stainless steel with hydrophobic cloth
Environmental:	IEC 60529, IP44	PI version: IEC 60529, IP55
Suspension:	(8) M10 suspension points	
Color:	Black or white	
Dimensions (H x W x D):	684 mm x 433 mm x 451 mm (26.91 in x 17.05 in x 17.77 in)	
Net weight:	25.0 kg (55.1 lb)	
Shipping weight:	27.7 kg (61.0 lb)	

<sup>1</sup>Full-space measurement.

<sup>2</sup>EIA RS-426A, tested for eight hours.

<sup>3</sup>With recommended preset.

# EVC Compact Front-Loaded Loudspeakers

## Frequency response and impedance:

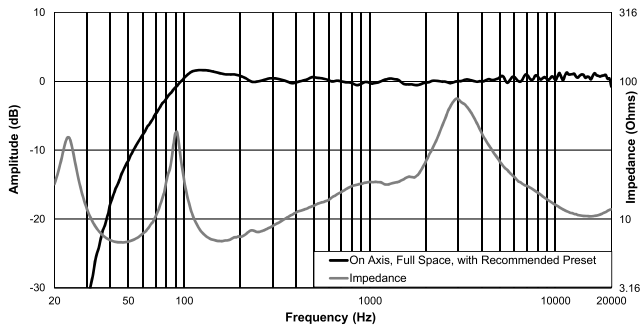

## Horizontal off-axis frequency response:

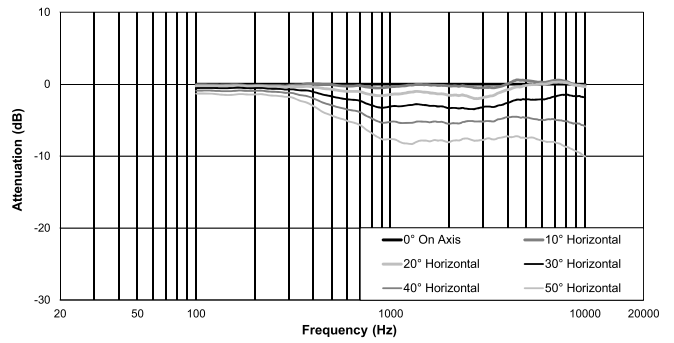

## Vertical off-axis frequency response (down):

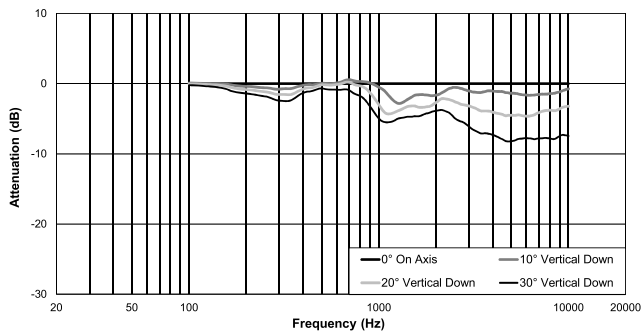

## Vertical off-axis frequency response (up):

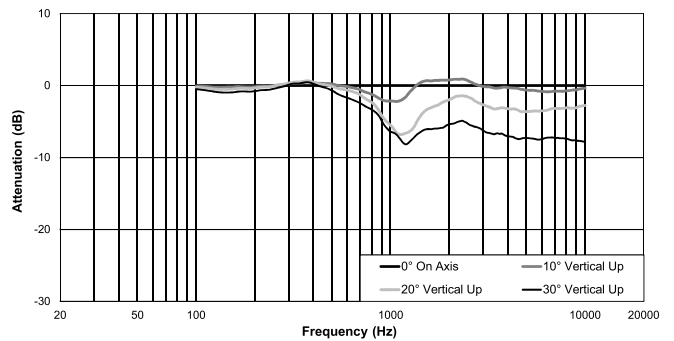

## Beamwidth:

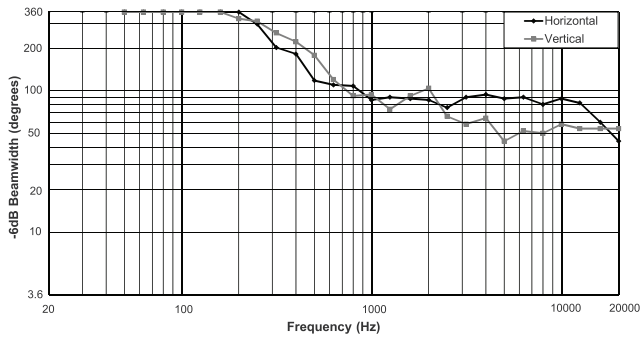

## Dimensions:

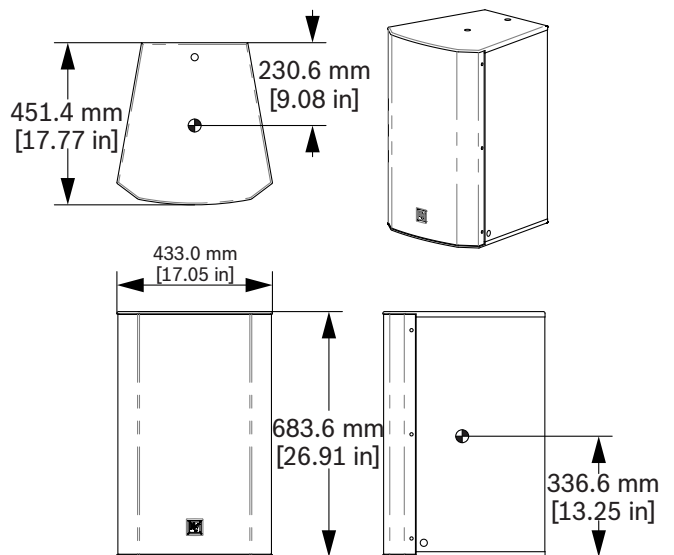



## 7.7

**EVC-1181S 18" subwoofer**

Frequency response (-3 dB) <sup>1, 3</sup> :	38 Hz - 95 Hz	
Frequency range (-10 dB) <sup>1, 3</sup> :	30 Hz - 135 Hz	
Rec. high-pass frequency, 4 <sup>th</sup> -order Butterworth:	35 Hz for 8Ω operation 40 Hz with TK-150 transformer	
Axial sensitivity <sup>1</sup> :	97 dB (1 W/1 m)	
Max. calculated SPL <sup>1</sup> :	129 dB	
Power handling <sup>2</sup> :	400 W (Continuous), 1600 W (Peak)	
Nominal impedance:	8 Ω	
Minimum impedance:	6.3 Ω	
LF transducer:	EVS-18L	
Connectors:	Dual four-pin 10 AWG Phoenix/Euro Block screw-terminals	
Enclosure:	15-mm plywood with EVCoat	
Grille:	18 GA powder-coated steel with rotatable logo	PI version: 18 GA stainless steel with hydrophobic cloth
Environmental:	IEC 60529, IP44	PI version: IEC 60529, IP55
Suspension:	(8) M10 suspension points	
Color:	Black or white	
Dimensions (H x W x D):	503 mm x 554 mm x 718 mm (19.78 in x 21.81 in x 28.27 in)	
Net weight:	32.6 kg (71.9 lb)	
Shipping weight:	36.5 kg (80.5 lb)	

<sup>1</sup>Half-space measurement.

<sup>2</sup>EIA RS-426A, tested for eight hours.

<sup>3</sup>With recommended preset.

# EVC Compact Front-Loaded Loudspeakers

## Frequency response and impedance:

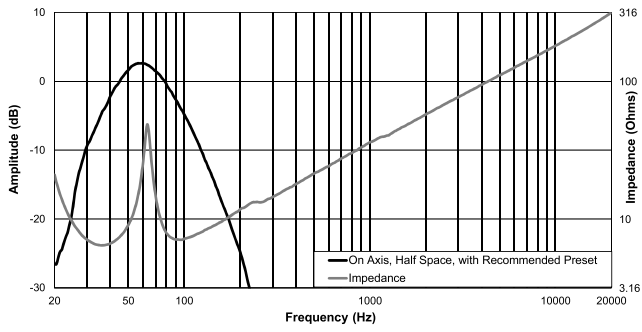

## Dimensions:

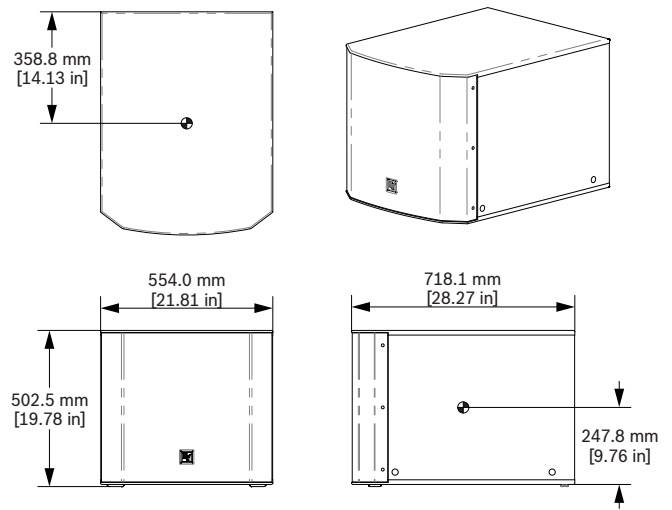

## 8 Accessories (optional)

### 8.1 Installation of TK-150 transformer for passive crossovers

#### Tools required:

- Phillips #2 screwdriver
- 3/16-inch (5 mm) flat blade screwdriver

#### High Pass Filter Requirements:



#### Caution!

Failure to use the proper high-pass filter may result in damage to the amplifier.

The TK-150 audio transformer is designed to be used with Butterworth 24 dB/octave high-pass filter inserted in the signal chain at the input to the amplifier. The filter corner frequency should be set at 50 Hz for full-range models and at 40 Hz for the EVC-1181S subwoofer. This filter, in conjunction with the Automatic Saturation Compensation (ASC) feature, protects the amplifier from damage caused by transformer saturation at low frequencies and allows any number of transformers to be driven on the same 70V or 100V line, up to the rated power of the amplifier. At the same time, the ASC circuit preserves the low-frequency extension of the system by adding incremental filtering only to the extent required by the current level in the loudspeaker. Following the parameters below, the TK-150 is capable of delivering up to 300 Watts to the loudspeaker by connecting a 100V drive line to the tap labeled *DO NOT USE* (150W at 70.7V) if a Butterworth 24 dB/octave active high-pass filter tuned to 66 Hz or higher is inserted in the signal chain at the input to the driving amplifier.



#### Notice!

Each group of four terminals is electrically connected in parallel to the group of four terminals directly across from it.

The wattages charted in these two columns represent the wattage available from each of the three transformer taps at the designated voltage.

	<b>70V</b>	<b>100V</b>	<b>Z nom</b>
Transformer: (Standard 50 Hz BW20 High-pass)	37.5 W	75 W	130 Ω
	75 W	150 W	65 Ω
	150 W	Do Not Use	33 Ω
Transformer: 89 Hz High-pass per EN54-24 spectrum	50 W	100 W	100 Ω
	100 W	200 W	50 Ω
	200 W	400 W	25 Ω

**Table 8.1: Transformer ratings and taps**

# EVC Compact Front-Loaded Loudspeakers

## Installing the TK-150 transformer



### Caution!

This transformer affects only the loudspeaker to which it is installed. Improper connection may result in damage to the transformer, successive loudspeakers, the driving amplifier or any combination of these units.



### Caution!

When daisy chaining additional systems, connect the wires to the next system only to those terminals directly opposite the input wires. Improper connection may result in damage to the transformer, successive loudspeakers, the driving amplifier or any combination thereof.



### Notice!

Tighten all unused connector screws to prevent rattles.



### Notice!

The TK-150 ships with two input panel labels, one label is for standard use, and one label is for EN54-24 Voice alarm systems.

Apply the TK-150 EN54 rated label when TK-150 is used in an EN54-24 system.

To **install the TK-150**, do the following:

1. Remove the **input panel** by removing the eight screws securing it.  
*Make note of the original orientation prior to removing the input panel.*
2. Place the **input panel** horizontally face down with the green circuit board on the right.

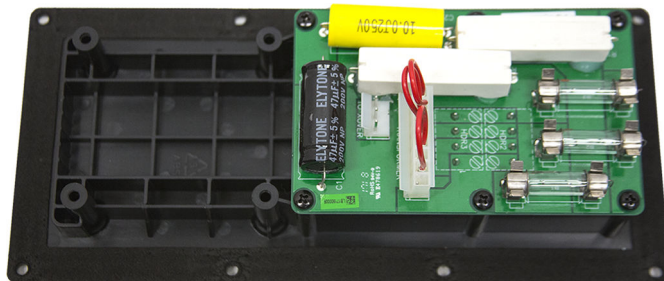

3. Place the **transformer** in the pocket on the left.  
*The lead wires from the transformer should be pointed toward you.*

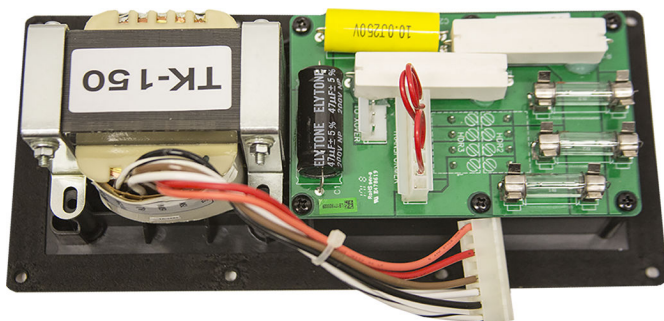

- Secure the **transformer mounting ears** to the four input panel bosses with the four #10 screws (A) provided.

*Carefully tighten the screws evenly in an X-cross pattern to avoid warping the plastic input panel.*

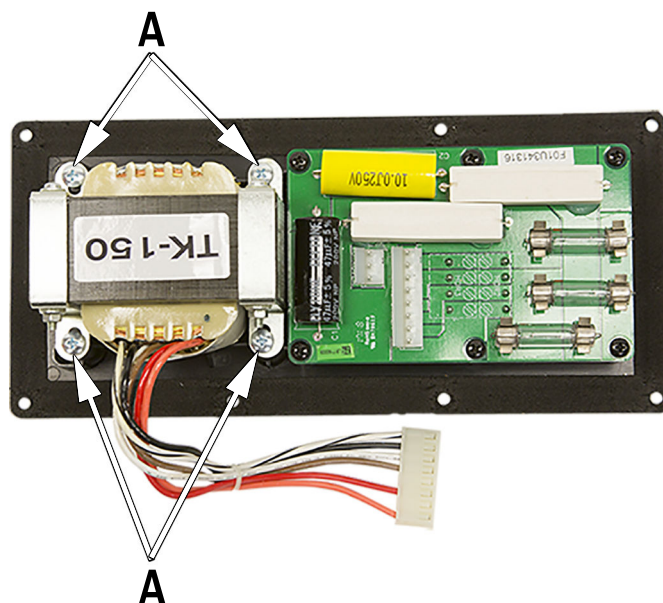

- Unplug the **8-position jumper connector** located at right angle to the 7-pin crossover header.
- Plug in the **8-position wiring harness connector (B)** from the transformer to the 8-pin header in place of the jumper.

*Notice the direction of the connector.*

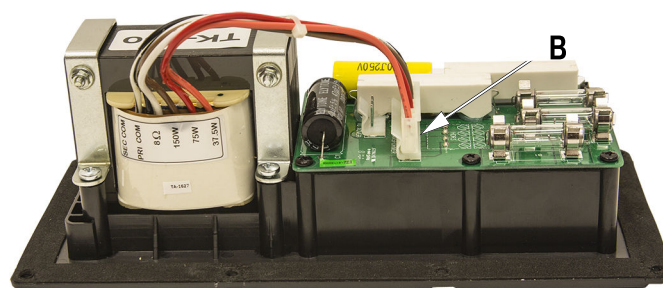

- Reinstall the **input panel** in the same orientation it was in before removal.  
*Do not install backwards.*
- Apply the **new label** (supplied) over the input connectors.
- Connect the **(-) input line** to the COM input terminal and the **(+) input line** to the terminal corresponding to the desired wattage in either the 70.7V or 100V column.

#### **Automatic Saturation Compensation**

When the TK-150 transformer is installed in an EVC loudspeaker, it engages EV's patented Automatic Saturation Compensation (ASC), which preserves low frequency performance while presenting a stable load to the amplifier - regardless of the number of speakers connected in parallel. As a result, EVC loudspeakers - including the subwoofers - sound virtually identical, whether they are used with a transformer or without.

## 8.2 Input panel covers

For all EVC loudspeakers. Electro-Voice offers input panel covers that protect the electrical connections from moisture in outdoor installations or give the user of using quick-release NL4 type speaker connectors.



CDG: optional dual-gland-nut input-panel cover to protect the input connections from water. Note that this cover is supplied with the PI versions.



CSG: optional single-gland-nut input-panel cover to protect the input connections from water.



CDNL4: optional input-panel cover equipped with dual Neutrik Speakon NL4M connectors, providing a quick-disconnect -alternative to the standard Phoenix screw-terminal input connectors.

These are the same input panel accessories that fit all EV-Innovation loudspeaker models.

## 9 References

### 9.1 Rigging (printed)

[1] W.E. Rossnagel, L.R. Higgins & J.A. MacDonald, Handbook of Rigging for Construction and Industrial Operations, McGraw-Hill Book Company, New York, NY, USA (2009).

[2] H. Donovan, Entertainment Rigging, <http://www.riggingbooksandprograms.com>, Rigging Seminars, Seattle, WA, USA (2002).

[3] J.O. Glerum, Stage Rigging Handbook, Southern Illinois University Press, Carbondale, IL, USA (2007).

[4] P. Carter, Backstage Handbook, Broadway Press, New York, NY, USA (1994).

[5] J. A. Klinke, Rigging Handbook, ACRA Enterprises, Inc., Stevensville, MI, USA (2012).

[6] Wire Rope Technical Board, Wire Rope Users Manual, American Iron and Steel Institute, Stevensville, MD, USA (2005).

[7] D. L. Hall, Rigging Math Made Simple, Spring Knoll Press, Johnson City, TN (2014).

[8] Newberry, W.G., Handbook for Riggers, Newberry Investments Company, Calgary, Alberta, Canada (1989).

-----  
1. \*All other trademarks are property of their respective owners.

### 9.2 Mechanical engineering (printed)

[1] R.C. Hibbeler, Engineering Mechanics Statics & Dynamics, Pearson Prentice Hall, Upper Saddle River, NJ, USA (2012).

[2] R.C. Hibbeler, Mechanics of Materials, Pearson Prentice Hall, Upper Saddle River, NJ, USA (2012).

[3] J.L. Meriam & L.G. Kraige, Engineering Mechanics, Volume One - Statics, John Wiley & Sons, Inc., New York, NY, USA (2011).

[4] J.L. Meriam & L.G. Kraige, Engineering Mechanics, Volume Two - Dynamics, John Wiley & Sons, Inc., New York, NY, USA (2012).

[5] J.E. Shigley & C.R. Mischke, Mechanical Engineering Design, McGraw-Hill Book Company, New York, NY, USA (2014).

### 9.3 Rigging (websites)

[1] <http://www.rigging.net>

[2] <http://www.cmworks.com/>

**Bosch Sicherheitssysteme GmbH**

Robert-Bosch-Ring 5

85630 Grasbrunn

Germany

**[www.boschsecurity.com](http://www.boschsecurity.com)**

© Bosch Sicherheitssysteme GmbH, 2018

**Bosch Security Systems, Inc**

12000 Portland Avenue South

Burnsville MN 55337

USA

**[www.electrovoice.com](http://www.electrovoice.com)**

