

USER MANUAL

MODEL:

VS-44UHD 4x4 UHD Matrix Switcher



Contents

Introduction	1
Getting Started	1
Overview	2
Typical Applications	3
Controlling your VS-44UHD	3
Defining the VS-44UHD 4x4 UHD Matrix Switcher	4
Installing in a Rack	6
Connecting the VS-44UHD	7
Connecting to VS-44UHD via RS-232	8
Connecting VS-44UHD via the ETHERNET Port	8
Operating VS-44UHD via Front Panel Buttons	11
Routing the Signals	11
Storing and Recalling a Setup	17
Setting the Switching Mode	18
Setting the Switching Speed	19
Setting HDCP	19
Copying the EDID	20
Firmware Upgrade	21
Using the Embedded Web Pages	22
Switching and Setting the Ports	24
Changing Device Settings and Upgrading the Firmware	32
Managing Web Page Security	33
Setting the Timeout	36
Setting Switching Modes	38
Setting Step-In Devices	39
Managing the EDID	41
Viewing the About Us Page	45
Technical Specifications	46
Default Communication Parameters	46
Default Parameters	47
Protocol 3000	48
Understanding Protocol 3000	49
Kramer Protocol 3000 Syntax	50
Protocol 3000 Commands	51

Introduction

Welcome to Kramer Electronics! Since 1981, Kramer Electronics has been providing a world of unique, creative, and affordable solutions to the vast range of problems that confront the video, audio, presentation, and broadcasting professional on a daily basis. In recent years, we have redesigned and upgraded most of our line, making the best even better!

Our 1,000-plus different models now appear in 15 groups that are clearly defined by function: GROUP 1: Distribution Amplifiers; GROUP 2: Switchers and Routers; GROUP 3: Control Systems; GROUP 4: Format & Standards Converters; GROUP 5: Range Extenders & Repeaters; GROUP 6: Specialty AV Products; GROUP 7: Scalers; GROUP 8: Cables and Connectors; GROUP 9: Room Connectivity; GROUP 10: Mounting and Rack Adapters; GROUP 11: Sierra Video; GROUP 12: Digital Signage; GROUP 13: Audio; GROUP 14: Collaboration; and GROUP 15: KM & KVM Switches.

Getting Started

We recommend that you:

- Unpack the equipment carefully and save the original box and packaging materials for possible future shipment.
- Review the contents of this user manual.



Go to www.kramerav.com/downloads/VS-44UHD to check for up-to-date user manuals, application programs, and to check if firmware upgrades are available (where appropriate).

Achieving the Best Performance

- Use only good quality connection cables (we recommend Kramer high-performance, high-resolution cables) to avoid interference, deterioration in signal quality due to poor matching, and elevated noise levels (often associated with low quality cables).
- Do not secure the cables in tight bundles or roll the slack into tight coils.
- Avoid interference from neighbouring electrical appliances that may adversely influence signal quality.
- Position your Kramer **VS-44UHD** away from moisture, excessive sunlight and dust.



This equipment is to be used only inside a building. It may only be connected to other equipment that is installed inside a building.

Safety Instructions



Caution: There are no operator serviceable parts inside the unit.

Warning: Use only the power cord that is supplied with the unit.

Warning: Do not open the unit. High voltages can cause electrical shock! Servicing by qualified personnel only.

Warning: Disconnect the power and unplug the unit from the wall before installing.

Recycling Kramer Products

The Waste Electrical and Electronic Equipment (WEEE) Directive 2002/96/EC aims to reduce the amount of WEEE sent for disposal to landfill or incineration by requiring it to be collected and recycled. To comply with the WEEE Directive, Kramer Electronics has made arrangements with the European Advanced Recycling Network (EARN) and will cover any costs of treatment, recycling and recovery of waste Kramer Electronics branded equipment on arrival at the EARN facility. For details of Kramer's recycling arrangements in your particular country go to our recycling pages at www.kramerav.com/support/recycling.

Overview

Congratulations on purchasing your Kramer **VS-44UHD**.

VS-44UHD is a high-quality 4x4 matrix switcher for 4K@60Hz (4:2:0) HDMI™ signals and embedded audio. It reclocks and equalizes the signals and can route any or all of four HDMI, HDCP-compliant sources to any or all outputs simultaneously. **VS-44UHD** offers a flexible audio scheme where any HDMI digital audio input can be routed to any HDMI digital audio output in addition to ARC support on all ports to produce an equivalent 8x8 audio matrix.

The **VS-44UHD** provides exceptional quality, advanced and user-friendly operation, and flexible control.

Exceptional Quality

- Max. data rate – 8.91Gbps data rate (2.97Gbps per graphics channel).
- Max. resolution – Up to 4K@60Hz UHD (4:2:0).
- Kramer Step-in over HDMI technology.
- HDMI, HDCP and DVI compliance.
- HDMI support – Deep color, 3D, ARC, up to 7.1 uncompressed audio channels.
- Kramer reKlocking™ and equalization technology – Rebuilds the digital signal to travel longer distances.

Advanced and User-friendly Operation

- Automatic input selection – By priority selection or last connected input.
- Embedded pattern generator (480p) – With selectable patterns.
- Selectable HDCP Off per input.
- Memory locations – eight presets for quick access to common configurations.
- Advanced EDID management per input.
- Active source and acceptor detection.
- Easy front-panel operation.
- Selectable switching speed.
- Lock button to prevent tampering.

- Kramer protocol 3000 support.
- Firmware upgrade via mini USB, Ethernet or the RS-232 port.
- Control Options – RS-232 serial commands transmitted by a PC, touch screen system or other serial controller, Ethernet port via LAN and embedded web pages.
- 7-segment display, indicating the video and audio status and other functions.
- Efficient power-saving features.
- Includes non-volatile memory that retains the last settings after switching the power off and then on again.

Flexible Connectivity

- 8x8 Audio Matrix – With 4 embedded digital inputs + 4 ARC inputs and 4 digital outputs + 4 ARC outputs.
- 4x4 switching for HDMI signals.
- ARC from HDMI outputs to HDMI inputs 1 to 4.
- Supports Step-in function.
- Housed in a 19" 1U rack mountable enclosure, with rack ears included, and is fed from a 100-240 VAC universal switching power supply.

Typical Applications

The **VS-44UHD** is ideal for the following typical applications:

- Control rooms with multiple displays.
- Presentation and multimedia applications.
- Systems that require automatic HDMI routing.

Controlling your VS-44UHD

Control your **VS-44UHD** directly via the front panel push buttons, or:

- By RS-232 serial commands transmitted by a touch screen system, PC, or other serial controller.
- Via the Ethernet using built-in user-friendly web pages.

Defining the VS-44UHD 4x4 UHD Matrix Switcher

This section defines the VS-44UHD.

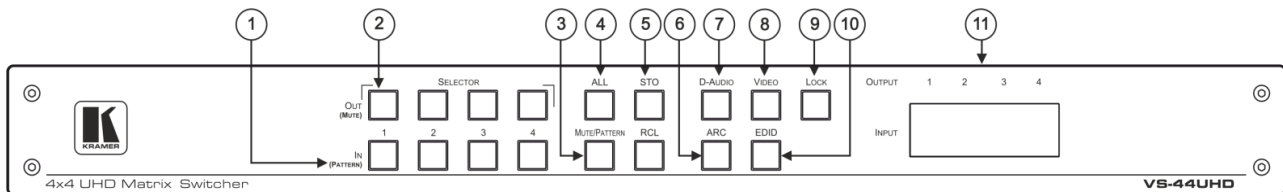

Figure 1: VS-44UHD 4x4 UHD Matrix Switcher Front Panel

#	Feature	Function
		The behavior of the front panel buttons and the 7-segment display changes along with the operation modes. For further details see Operating VS-44UHD via Front Panel Buttons on page 11.
①	IN (PATTERN) SELECTOR Buttons	Press to select the input (1 to 4) to switch after selecting an output (also used for storing machine setups in the STO-RCL modes and for selecting a pattern in the Pattern mode).
②	OUT (MUTE) SELECTOR Buttons	Press to select an output (1 to 4) to which the input is routed. Also used for storing machine presets.
③	MUTE/PATTERN Button	Press to view the current pattern status and select the output/s to which a pattern is routed. Press to mute audio or video on a selected output when D-AUDIO and/or VIDEO buttons are pressed (lit).
④	ALL Button	Press to perform an action on all outputs (for example setting Mute mode, Pattern mode and so on). For switching, press ALL and then a specific INPUT button to route the selected input to all outputs. For example, press ALL and then IN 2 to route input 2 to all the outputs.
⑤	STO and RCL Buttons	Press STO to store the current switching setting to a preset button. Press RCL to recall the switching setting from a preset button.
⑥	ARC	For setting ARC mode on the inputs (see Operating in ARC Mode on page 16).
⑦	D-AUDIO Button	Press to enable digital audio routing. When pressed together with VIDEO, the digital audio is routed together with the video signal.
⑧	VIDEO Button	Press to select video inputs. When pressed together with D-AUDIO, video is switched together with audio.
⑨	LOCK Button	Press and hold to toggle between locking and releasing the front panel buttons. Press to save the following setups: HDCP (On/Off), ARC, Fast Switch and Switch mode.
⑩	EDID Button	Press to capture the EDID (see Copying the EDID on page 20).
⑪	OUTPUT/INPUT 7-segment LED Display	Displays the selected inputs switched to the outputs (marked above each input).

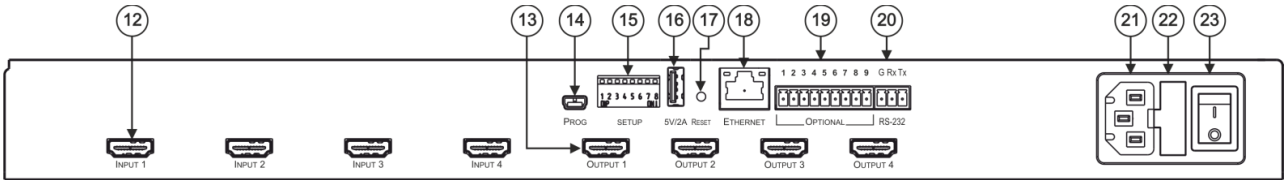

Figure 2: VS-44UHD 4x4 UHD Matrix Switcher Rear Panel

#	Feature	Function
12	INPUT HDMI Connectors	Connect to HDMI sources (from 1 to 4).
13	OUTPUT HDMI Connectors	Connect to HDMI acceptors (from 1 to 4).
14	PROG Mini USB Port	Use for firmware upgrade or communication (connecting to a PC or a serial controller).
15	SETUP DIP-Switches	N/A
16	5V/2A USB Port	Can be used to charge an external device.
17	RESET Button	Press and hold to reset settings to factory default values.
18	ETHERNET RJ-45 Port	Connect to your LAN.
19	OPTIONAL Terminal Block Connectors	N/A
20	RS-232 3-pin Terminal Block Connectors	Connect to a PC or a serial controller.
21	Mains Power Connector	Connect to the mains power.
22	Mains Power Fuse	Fuse for protecting the device.
23	Mains Power Switch	Switch for turning the device on or off.

Installing in a Rack

This section provides instructions for rack mounting **VS-44UHD**. Before installing in a rack, verify that the environment is within the recommended range:

- Operation temperature – 0° to 40°C (32 to 104°F).
- Storage temperature – -40° to +70°C (-40 to +158°F).
- Humidity – 10% to 90%, RHL non-condensing.



When installing on a 19" rack, avoid hazards by taking care that:

- It is located within recommended environmental conditions. Operating ambient temperature of a closed or multi-unit rack assembly may exceed ambient room temperature.
- Once rack mounted, there is enough air flowing around **VS-44UHD**.
- **VS-44UHD** is placed upright in the correct horizontal position.
- You do not overload the circuit(s). When connecting **VS-44UHD** to the supply circuit, overloading the circuits may have a detrimental effect on overcurrent protection and supply wiring. Refer to the appropriate nameplate ratings for information. For example, for fuse replacement, see the value printed on the product label.
- **VS-44UHD** is earthed (grounded) and connected only to an electricity socket with grounding. Pay particular attention when electricity is supplied indirectly (for example, when the power cord is not plugged directly into the wall socket but to an extension cable or power strip). Use only the supplied power cord.

To rack-mount **VS-44UHD**:

1. Attach both rack ears to **VS-44UHD**:
Remove the screws from each side of **VS-44UHD** (3 on each side), and replace them through the rack ears.
2. Place the rack ears of **VS-44UHD** against the rack rails and insert the appropriate screws (not provided) through each of the four holes in the rack ears.

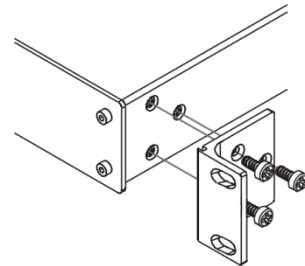

Connecting the VS-44UHD

 Always switch off the power to each device before connecting it to your **VS-44UHD**. After connecting your **VS-44UHD**, connect its power and then switch on the power to each device.

 Although this connecting example shows only several inputs and outputs that are connected, you can connect all the inputs and outputs simultaneously.

To connect the **VS-44UHD** as illustrated in the example in [Figure 3](#), do the following:

1. Connect up to four video sources to the HDMI inputs ⁽¹²⁾ (from INPUT 1 to INPUT 4). For example, connect:
 - A laptop to the INPUT 1 and 4 HDMI connectors.
 - Blu-ray players to the INPUT 2 and 3 HDMI connectors.
2. Connect the four video HDMI outputs ⁽¹³⁾ (from OUTPUT 1 to OUTPUT 4) to up to four acceptors. For example, connect the:
 - OUTPUT 1 HDMI connector to a projector.
 - OUTPUT 2, OUTPUT 3 and OUTPUT 4 HDMI connectors each to a display.
3. Connect the power cord ⁽²¹⁾.
We recommend that you use only the power cord that is supplied with this machine.
4. Connect the:
 - ETHERNET port ⁽¹⁸⁾ to a system controller.
 - RS-232 3-pin terminal block connector ⁽²⁰⁾ to a system controller.
5. If required, connect the 5V/2A USB port ⁽¹⁶⁾ to a device to charge it.

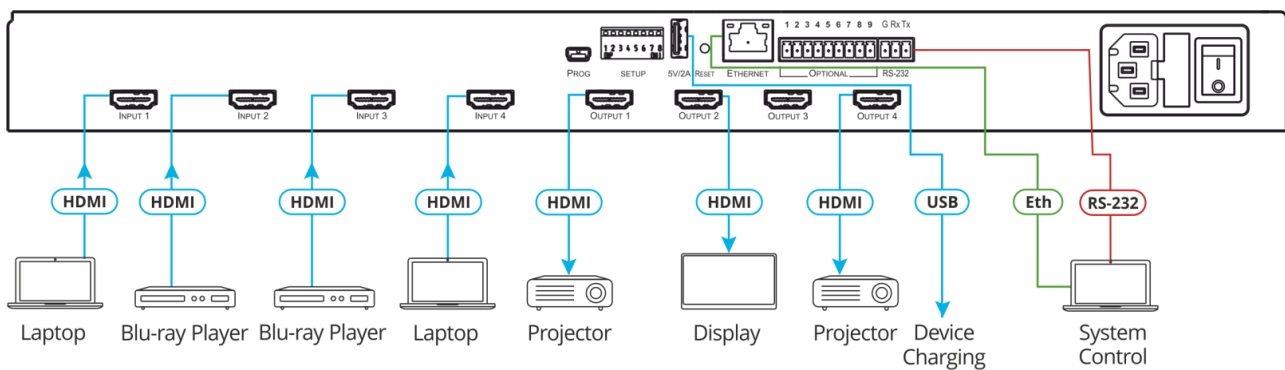

Figure 3: Connecting to the VS-44UHD Rear Panel

Connecting to VS-44UHD via RS-232

You can connect to the VS-44UHD via an RS-232 connection ⁽²⁰⁾ using, for example, a PC.

Connect the RS-232 terminal block on the rear panel of the VS-44UHD to a PC/controller, as follows:

- TX pin to Pin 2.
- RX pin to Pin 3.
- GND pin to Pin 5.

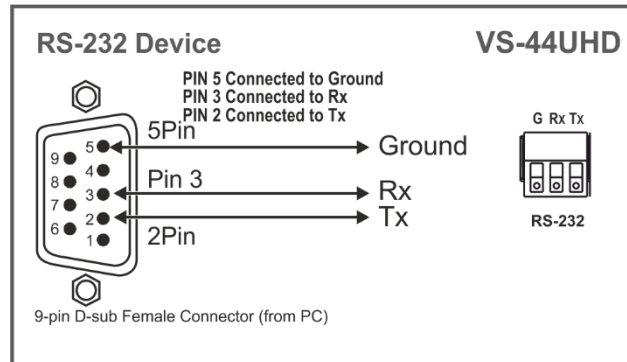

Figure 4: RS-232 Connection

Connecting VS-44UHD via the ETHERNET Port

You can connect to the VS-44UHD via Ethernet using either of the following methods:

- Directly to the PC using a crossover cable (see [Connecting the Ethernet Port Directly to a PC](#) on page 8).
- Via a network hub, switch, or router, using a straight-through cable (see [Connecting the Ethernet Port via a Network Hub or Switch](#) on page 10).



If you want to connect via a router and your IT system is based on IPv6, speak to your IT department for specific installation instructions.

Connecting the Ethernet Port Directly to a PC

You can connect the Ethernet port of the VS-44UHD directly to the Ethernet port on your PC using a crossover cable with RJ-45 connectors.



This type of connection is recommended for identifying the VS-44UHD with the factory configured default IP address.

After connecting the VS-44UHD to the Ethernet port, configure your PC as follows:

1. Click **Start > Control Panel > Network and Sharing Center**.
2. Click **Change Adapter Settings**.
3. Highlight the network adapter you want to use to connect to the device and click **Change settings of this connection**.

The Local Area Connection Properties window for the selected network adapter appears as shown in [Figure 5](#).

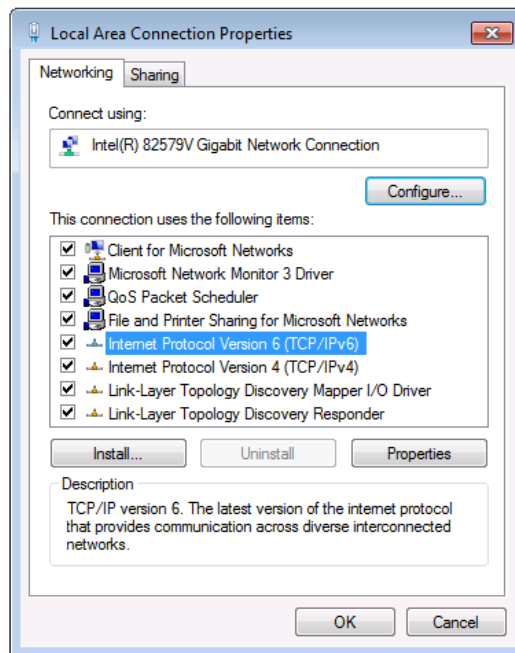

Figure 5: Local Area Connection Properties Window

4. Highlight either **Internet Protocol Version 6 (TCP/IPv6)** or **Internet Protocol Version 4 (TCP/IPv4)** depending on the requirements of your IT system.
5. Click **Properties**.

The Internet Protocol Properties window relevant to your IT system appears as shown in [Figure 6](#) or [Figure 7](#).

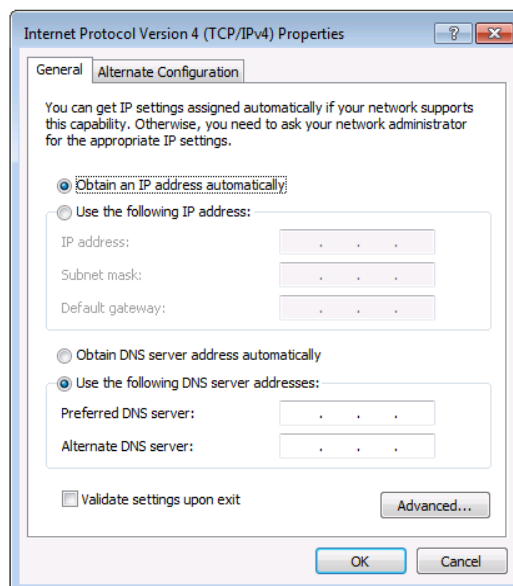

Figure 6: Internet Protocol Version 4 Properties Window

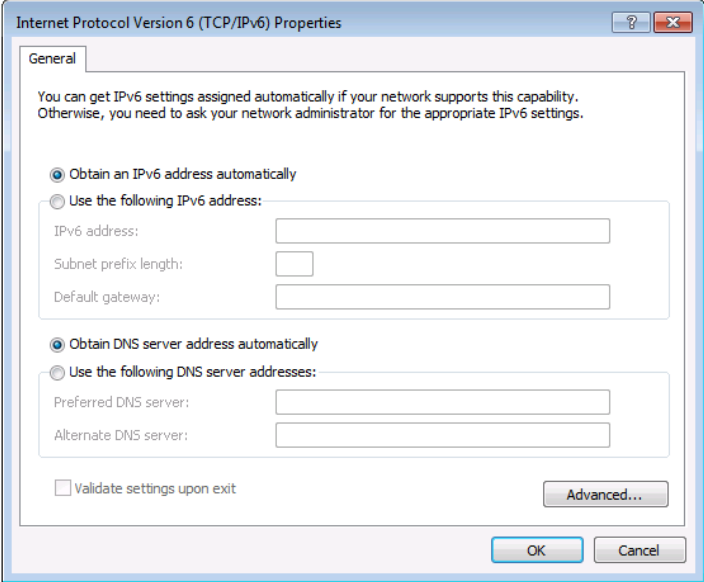

Figure 7: Internet Protocol Version 6 Properties Window

- 6. Select **Use the following IP Address** for static IP addressing and fill in the details as shown in [Figure 8](#).
For TCP/IPv4 you can use any IP address in the range 192.168.1.1 to 192.168.1.255 (excluding 192.168.1.39) that is provided by your IT department.

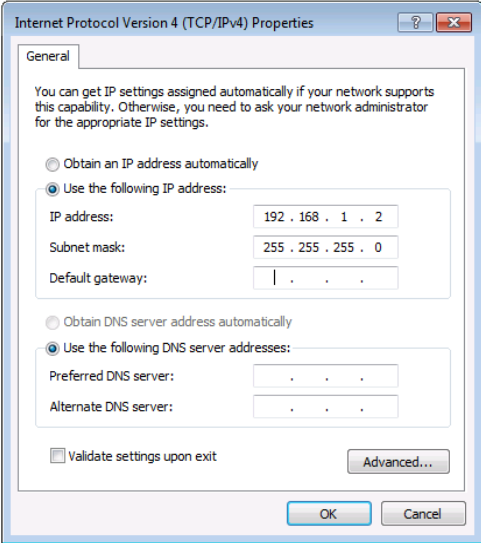

Figure 8: Internet Protocol Properties Window

- 7. Click **OK**.
- 8. Click **Close**.

Connecting the Ethernet Port via a Network Hub or Switch

You can connect the Ethernet port of the VS-44UHD to the Ethernet port on a network hub or using a straight-through cable with RJ-45 connectors.

Control Configuration via the Ethernet Port

To control several units via Ethernet, connect the Master unit (Device 1) via the Ethernet port to the Ethernet port of your PC. Use your PC provide initial configuration of the settings (see [Connecting VS-44UHD via the ETHERNET Port](#) on page 8).

Operating VS-44UHD via Front Panel Buttons

Press the power switch (25) to power the device. During the 10-second initialization process, the:

- 7-segment display LEDs (11) are on.
- All the front panel buttons illuminate.
- The FPGA/EPLD version (P), the firmware version (F) and the build version (b) appear in succession.

Following initialization, the front panel buttons and 7-segment display enter normal operation:

- The 7-segment display shows the video IN-OUT status.
- The current operation mode buttons illuminate (**VIDEO** (8) and **D-AUDIO** (7), by default).
- An illuminated **IN (PATTERN)** (1) button indicates an active signal connected to the input.
- An illuminated **OUT (MUTE)** (2) button indicates that an acceptor is connected to the output.

The VS-44UHD front panel buttons enable performing the following functions:

- [Routing the Signals](#) on page [11](#).
- [Storing and Recalling a Setup](#) on page [17](#).
- [Setting the Switching Mode](#) on page [18](#).
- [Setting the Switching Speed](#) on page [19](#).
- [Setting HDCP](#) on page [19](#).
- [Copying the EDID](#) on page [20](#).

Routing the Signals

You can switch the video and the audio signals together (AFV) or switch them separately, via the following switching modes:

- [Switching the Video Signal](#) on page [12](#).
- [Routing a Digital Audio Input to HDMI Outputs](#) on page [12](#).
- [Switching the Video and the Audio Signal Simultaneously](#) on page [13](#).
- [Muting/Unmuting an Output](#) on page [14](#).
- [Routing a Pattern to the Output](#) on page [14](#).
- [Operating in ARC Mode](#) on page [16](#).

Switching the Video Signal

The **VIDEO** button on the **VS-44UHD** front panel enables video routing.

To switch a video input to an output:

1. Press **VIDEO** (7).
The button illuminates and the 7-segment display (11) shows the current IN-OUT video status.



On the front panel buttons:

- An illuminated input button means that an active signal is detected on that input.
- An illuminated output button means that a display is connected to that output.
- A flashing output button means that a non-HDCP display is connected to that output.

Note that in the case that an HDCP-encrypted input is routed through the matrix to a non-HDCP screen, the video will not be presented and the non-HDCP screen will turn black.

On the 7-segment display:

- A digit (from 1 to 4) shows the input number that is currently routed to the output.
- “P” under an output number indicates that a pattern is routed to that output.
- “0” under an output number indicates that the output is muted.

2. Press an **OUT (MUTE)** (2) button (1 to 4).
The 7-segment display LED, under the selected output, flashes.



Press **ALL** (4) (instead of an output button) to route the selected input to all the outputs. All the 7-segment display LEDs flash.

3. Press an **IN (PATTERN)** button (1 to 4).
The selected input is switched to the selected output (or to all the outputs if **ALL** was pressed instead) and the 7-segment display shows the current status.

Routing a Digital Audio Input to HDMI Outputs

The **D-AUDIO** (7) button on the **VS-44UHD** front panel enables to route the HDMI embedded audio input signals (12) to the HDMI outputs (13).

Generally, digital routing is enabled by pressing **D-AUDIO**:

- When this button is illuminated, the HDMI input embedded audio is the audio source.

To switch an HDMI audio input to the HDMI outputs:

1. Press **D-AUDIO** (7).
The button illuminates (HDMI audio input to HDMI output mode) and the 7-segment display (11) shows the current IN-OUT digital audio status.



On the front panel buttons:

- An illuminated input button means that an active digital audio signal is detected on that input that supports LPCM audio.
- A dark input button means that there is no active digital audio source on that input (or that the source is DVI).
- A flashing input button means that a Dolby digital audio, Dolby-TrueHD audio, or AC-3 audio signal from a DVD -player is detected on that input.
- An illuminated output button means that a display that supports LPCM audio is connected to that output.
- A dark button means either that the display that is connected does not support audio or that a display is not connected at all.
- A flashing output button means that a display is connected that supports LPCM, Dolby digital, AC-3 and NLPCM audio.

On the 7-segment display:

- “0” under an output number indicates that the audio output is muted.
 - “.” under an output number indicates that the HDMI output port is in ARC mode.
 - Any digit shows the HDMI audio input switching state.
2. While **D-AUDIO** is on, select an output button (for example, 3) and then an input button (for example, 1). HDMI audio input 1 is routed to HDMI audio output 3 and on the 7-segment display, INPUT 1 appears under OUTPUT 3.

When switching you can also press:

- An output button (1 to 4) and then **OUT (MUTE)** ② to mute the selected output (turns 0).
- **ALL** ④ (instead of an output button) and then an input button to route the selected input to all the outputs.

All the 7-segment display LEDs flash and then display the selected input.

Switching the Video and the Audio Signal Simultaneously

You can switch the digital audio signal together with the video signal to the output.

To switch the digital audio and video signals together to an output:

1. Press **D-AUDIO** and **VIDEO** simultaneously.
The buttons illuminate and the 7-segment display ⑪ shows the current IN-OUT video status.
2. Press an **OUT (MUTE)** ② button (1 to 4).
The 7-segment display LED, under the selected output, flashes.



Press **ALL** ④ (instead of an output button) to route the selected input to all the outputs. All the 7-segment display LEDs flash.

3. Press an **IN (PATTERN)** button (1 to 4).
The selected audio input is switched to the selected output (or to all the outputs if **ALL** was pressed instead) and the 7-segment display shows the current status.

Muting/Unmuting an Output

You can mute/unmute an audio signal and a video signal separately.

To mute/unmute an audio signal:

1. Press **D-AUDIO**.
The buttons illuminate.
2. Press an **OUT (MUTE)** ② button (1 to 4).

 Press **ALL** ④ (instead of an output button) to mute/unmute all the outputs. All the 7-segment display LEDs flash.

3. Press **MUTE/PATTERN** ③ to mute/unmute the output.
The muted output appears as “0” on the 7-segment display.

To mute/unmute a video signal:

1. Press **VIDEO**.
The button illuminates and the 7-segment display ⑪ shows the current IN-OUT video status.
2. Press an **OUT (MUTE)** ② button (1 to 4).
The 7-segment display LED, under the selected output, flashes.

 Press **ALL** ④ (instead of an output button) to mute/unmute all the outputs. All the 7-segment display LEDs flash.

3. Press **MUTE/PATTERN** ③ to mute/unmute the output.
The muted output appears as “0” on the 7-segment display.

Routing a Pattern to the Output

VS-44UHD generates 8 embedded patterns. These patterns can be routed at a resolution of 480p to any of the outputs.

 Once a pattern is selected, that same pattern is routed to all the selected outputs.

A pattern is selected by pressing inputs 1 to 4 when in the Pattern mode as follows:

- When **MUTE/PATTERN** ③ is illuminated, press IN1 for pattern 1, IN 2 for pattern 2, IN 3 for pattern 3 and IN 4 for pattern 4.
- When **MUTE/PATTERN** ③ flashes, press IN1 for pattern 5, IN 2 for pattern 6, IN 3 for pattern 7 and IN 4 for pattern 8.

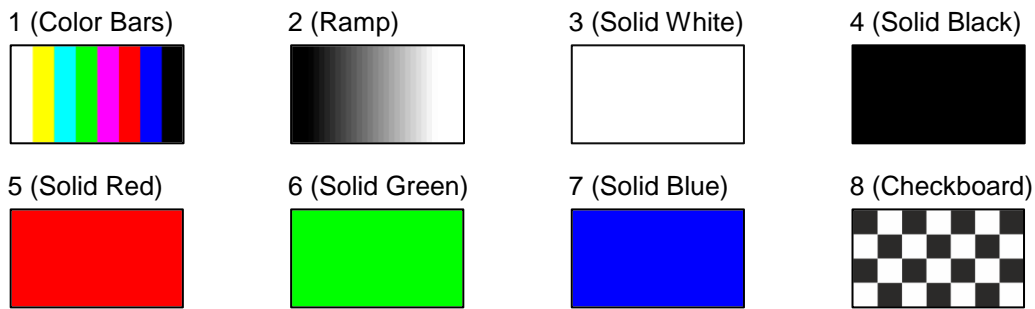

Figure 9: VS-44UHD Embedded Patterns

To route a pattern:

1. Press **MUTE/PATTERN** ^③:
 - Once: button illuminates, press IN 1 to IN 4 to select patterns 1 to 4.
 - Twice: button flashes, press IN 1 to IN 4 to select patterns 5 to 8.



On the front panel buttons:

- An illuminated output button means that a display is connected on that output.
- An illuminated input button indicates the current pattern selected.

On the 7-segment display:

- “**P**” under an output number indicates that a pattern is routed to that output.
- “**-**” under an output number indicates that a video input is routed to that output.
- “**0**” under an output number indicates that the output is muted.

2. Press an **OUT (MUTE)** ^② button (1 to 4).
The 7-segment display LED, under the selected output, flashes.



Press **ALL** ^④ (instead of an output button) to route a pattern to all the outputs. All the 7-segment display LEDs flash.

3. Press an input button to select a pattern (see [Figure 9](#)).
The 7-segment display shows the new pattern status.



Press **VIDEO**, **D-AUDIO** or **ARC** to exit pattern mode.

Operating in ARC Mode

ARC (Audio Return Channel) can be set via the front panel buttons or the embedded webpages (see [Switching Audio in Breakaway Mode](#) on page 29 and [Setting Input Parameters](#) on page 26).

Routing HDMI Audio Output Signals to HDMI Input Ports

To route an HDMI audio output to HDMI input ports, enable ARC on the HDMI output ports, enable ARC on input ports and then route HDMI OUT ARC to an HDMI input port.

To set an HDMI output to ARC mode:



ARC can be enabled or disabled at any time, regardless of whether a display is connected to the HDMI output or not.

1. Press and hold **MUTE/PATTERN** and **ALL** simultaneously until both buttons illuminate and the device enters ARC mode:



On the front panel button:

- A flashing output button means that the audio of that output is set to ARC mode.
- An illuminated output button means that the output is not in ARC mode.

2. Press one or more output buttons:

- If the selected button flashes, that output is set to ARC mode.
- If the selected button stops flashing, ARC mode is disabled for that output.

The **LOCK** button flashes.

3. Press **LOCK** to save changes.

The **LOCK** button flashes until the changes are saved. The device exits the ARC mode setup and returns to its previous status (either D-Audio mode or Video + D-Audio mode).

The ARC can now be routed to the inputs.

To route an HDMI OUT ARC to an HDMI input port:

1. Press **ARC**.

The button illuminates and the device enters the ARC routing mode (for example, HDMI OUT 2 and 4 are enabled).

Inputs flash and the ARC-enabled outputs illuminate.



On the front panel buttons:

- An illuminated input button means that it is a disabled ARC input.
- A flashing input button means that it is ARC-enabled.

On the 7-segment display:

- “.” under an output number indicates that arc is enabled on the corresponding output (outputs 1 to 4 in this example).
- A digit (from 1 to 4) under an output number indicates that that out ARC port is routed to that input.
- “0” under an output number indicates that the audio output is muted.

2. Press an input button (for example, IN 2) to select the destination port.
The corresponding 7-segment display LED flashes.
3. Press an output button (for example OUT 4) to select the HDMI audio output that will be routed to the input.
The flashing 7-segment display LED shows the selected input number and after selecting the HDMI audio OUT the port number appears (4).

HDMI OUT 4 audio signal is routed to ARC input 2.

To set an HDMI input to ARC mode:



Inputs can be set either to the Step-in mode or the ARC mode.

1. Press and hold **EDID** and **ALL** simultaneously until both buttons illuminate and the device enters ARC mode:



On the front panel button:

- A flashing input button means that it is set to ARC mode.
- An illuminated input button means that it is set to Step-in mode.

2. Press one or more input buttons:
 - If the selected button flashes, that input to set to ARC mode.
 - If the selected button stops flashing, ARC mode is disabled for that input.

The **LOCK** button flashes.

3. Press **LOCK** to save changes.
The **LOCK** button flashes until the changes are saved. The device exits the ARC mode setup and returns to its previous status (either D-Audio mode or Video + D-Audio mode).



Press **LOCK** within 15 seconds to apply settings. Otherwise, action times out.

Storing and Recalling a Setup

VS-44UHD can store up to 8 setups. Each setup includes the video and audio current switching state, the EDID, the ARC/audio mode, and the switch mode and speed.

In Store-Recall mode, OUT 1 corresponds to setup 1, IN 1 corresponds to setup 5, and so on.

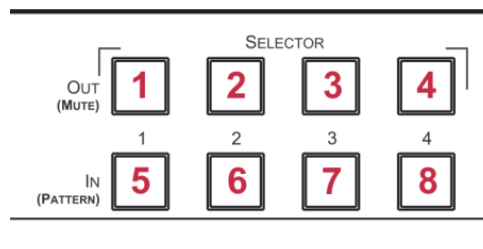



Figure 10: VS-44UHD 4x4 UHD Matrix Switcher Front Panel

To store a setup:

1. Press **STO** .

The **STO** button illuminates.
2. Press an **IN** or an **OUT** button (from 1 to 4).

For example, when pressing IN 4, the current device state is stored to setup 8.
3. Press **STO**.

The current device state is stored to setup 8 and the **STO** button no longer illuminates.



Press **STO** within 15 seconds to apply settings. Otherwise, action times out.

To recall a setup:

1. Press **RCL** .

The **RCL** button illuminates.
2. Press an **IN** or **OUT** button to recall the setup stored in that IN/OUT.

The selected button flashes.



If a setup is stored in the selected setup button, the corresponding 7-segment display LED flashes. If nothing is stored, the 7-segment LED is on.

3. Press **RCL**.

The recalled setup is applied and the **RCL** button no longer illuminates.



Press **RCL** within 15 seconds to apply settings. Otherwise, action times out.

Setting the Switching Mode

Set the following switching modes separately for each output:

- Manual mode (**IN 1**): inputs are switched to outputs via the front panel buttons.
- Priority mode (**IN 2**): the **VS-44UHD** switches the source with the highest priority to the output.
- Last connected mode (**IN 3**): the last detected active source is switched to the output.

To select the switching mode:

1. Press **RCL** and **MUTE/PATTERN** simultaneously. Both buttons illuminate.
2. Press an output button (or press **ALL**).

The corresponding 7-segment display LEDs flash and **LOCK** button flashes.
3. Press **IN 1**, **IN 2** or **IN 3**.
4. Press **LOCK** to save the settings to that output and exit Switching mode.



Press **LOCK** within 15 seconds to apply settings. Otherwise, action times out.

Setting the Switching Speed

Set the following switching speed modes separately for each output:

- Ex-Fast switch speed (**IN 1**).
- Fast switch speed (**IN 2**).
- Normal switch speed (**IN 3**).

To select the switching speed:

1. Press **STO** and **MUTE/PATTERN** simultaneously. Both buttons illuminate. The 7-segment display LEDs show the current switch speed for each port.
2. Press an output button (or press **ALL**). The corresponding 7-segment display LEDs flash and **LOCK** button flashes.
3. Press **IN 1**, **IN 2** or **IN 3**.
4. Press **LOCK** to save the settings and exit Speed mode.



Press **LOCK** within 15 seconds to apply settings. Otherwise, action times out.

Setting HDCP

You can enable or disable HDCP for each of the HDMI inputs.

To set HDCP on or off:

1. Press and hold **EDID** and **RCL** until both buttons illuminate. The IN buttons indicate the HDCP status:
 - HDCP enabled (on): IN button is illuminated.
 - HDCP disabled (off): IN button is off.
2. Press one or more input buttons to change their status. The **LOCK** button flashes.
3. Press **LOCK** to save changes and exit the HDCP mode.



Press **LOCK** within 15 seconds to apply settings. Otherwise, action times out.

Copying the EDID

You can copy the EDID to an input from a connected output or use the default EDID.

To copy the EDID from a connected output:

1. Press and hold **EDID** and **STO** until both buttons illuminate.
VS-44UHD enters the EDID mode and the 7-segment display shows the current EDID status:



On the front panel button:

- Both input and output buttons are dark.

On the 7-segment display:

- “**d**” under an output number indicates that the input port is set to the default EDID.
- “**L**” under an output number indicates that the EDID was uploaded externally from a file via web page.
- A digit under an output number indicates the output from which the EDID was copied.

2. Press one or more input buttons (or **ALL**).
The 7-segment display LEDs of the selected inputs flash.
3. Press an output button (with a connected display) from which to copy the EDID.
4. Press **EDID**.
Wait for about 5 seconds for the device to copy the EDID from the connected display.

To copy the default EDID:

1. Press and hold **EDID** and **STO** until both buttons illuminate.
VS-44UHD enters the EDID mode and the 7-segment display shows the current EDID status.
2. Press one or more input buttons (or **ALL**).
The 7-segment display LEDs of the selected inputs flash.
3. Press a disconnected output button.
4. Press **EDID**.
Wait for about 5 seconds for the device to copy the default EDID to the selected inputs.



Press **EDID** within 15 seconds to apply settings. Otherwise, action times out.

Firmware Upgrade

You can upgrade the **VS-44UHD** via:

- The Ethernet, using embedded web pages.
- By USB or RS-232 using Kramer K-UPLOAD tool.



The latest firmware version and the latest version of **K-UPLOAD** and installation instructions can be downloaded from the Kramer Web site at www.kramerav.com/downloads/VS-44UHD.

Using the Embedded Web Pages

The web pages let you control the **VS-44UHD** via the Ethernet. The web pages include all the OSD items and more, and are accessed using a Web browser and an Ethernet connection.

Before attempting to connect:

- Perform the procedures described in [Connecting VS-44UHD via the ETHERNET Port](#) on page [8](#).
- Ensure that your browser is supported.

The following operating systems and Web browsers are supported:

OS	Version	Browser
Windows	7	IE
		Firefox
		Chrome
		Safari
	10	IE
		Edge
		Firefox
		Chrome
Mac	10.11	Safari
iOS	10.3.2	Safari
Android	N/A	N/A

The **VS-44UHD** web pages enable performing the following:

- [Switching and Setting the Ports](#) on page [24](#).
- [Changing Device Settings and Upgrading the Firmware](#) on page [32](#).
- [Managing Web Page Security](#) on page [33](#).
- [Setting the Timeout](#) on page [36](#).
- [Setting Switching Modes](#) on page [38](#).
- [Setting Step-In Devices](#) on page [39](#).
- [Managing the EDID](#) on page [41](#).
- [Viewing the About Us](#) Page on page [45](#).

To browse the VS-44UHD web pages:

- 1. Open your Internet browser.
- 2. Type the IP address of the device in the address bar of your browser. For example, the default IP address:



The Authentication window appears (if set, security is enabled):

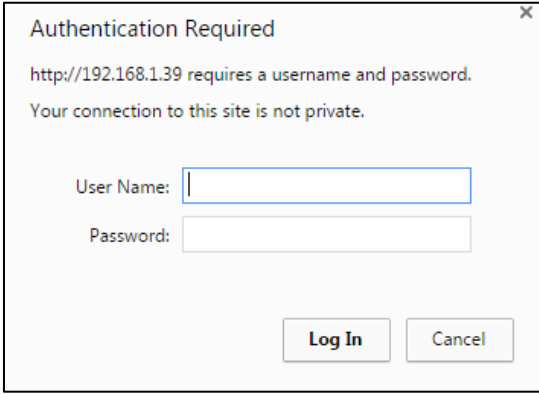

Figure 11: Using the Embedded Web Pages – Authentication

- 3. Enter the **User Name** and **Password** (Admin, empty string, by-default) and click **OK**. The Switching page appears:

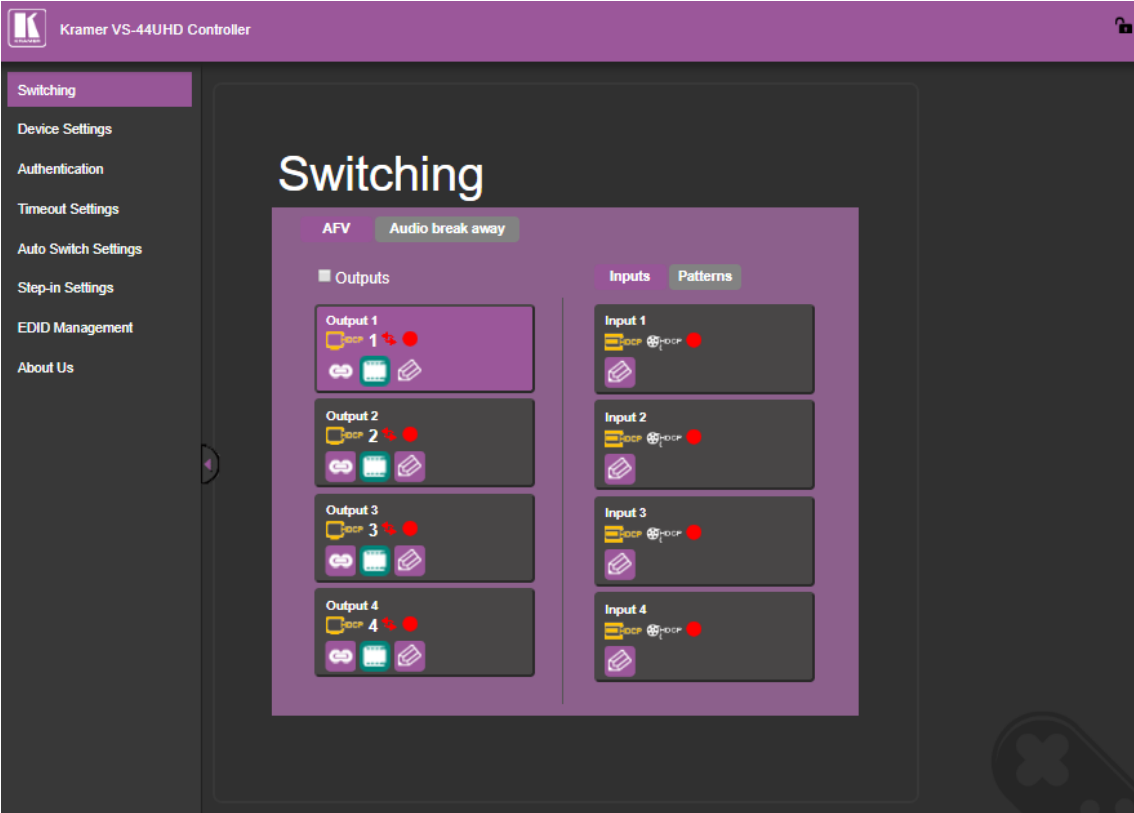

Figure 12: Switching Page with Navigation List on Left

- 4. Click the desired web page or click the arrow to hide the navigation list.

Switching and Setting the Ports

The Switching web page enables performing the following functions:

- [Viewing and Adjusting the Output Settings](#) on page [24](#).
- [Viewing and Adjusting the Input Settings](#) on page [26](#).
- [Switching an Input to an Output](#) on page [27](#).
- [Switching a Pattern to an Output](#) on page [28](#).
- [Switching Audio in Breakaway Mode](#) on page [29](#).

Viewing and Adjusting the Output Settings

You can view the status of the outputs and adjust their settings via the output buttons.

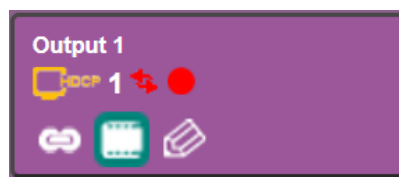

Figure 13: Switching Page – Output Button

Each output button displays the:

- HDCP status – output supports HDCP (HDCP icon) or does not support HDCP (HDCP icon).
- Switching speed – normal (Normal icon), fast (Fast icon) or extra-fast (Extra-Fast icon).
- Output status – an acceptor is connected (Green dot) or not connected (Red dot) to the output.
- AFV current operation mode – AFV (AFV icon) or audio breakaway (Audio Breakaway icon).

To adjust the output settings:

1. In the Navigation pane, click **Switching**. The Switching page appears.
2. Click the **AFV** tab.



The adjustment sequence presented here is only an example. You can adjust the output settings in any other order.



3. Click . The output settings window appears:



Figure 14: Switching Page – Editing the Output Button Settings

4. If required, type the label name in the **Label** text box and click .

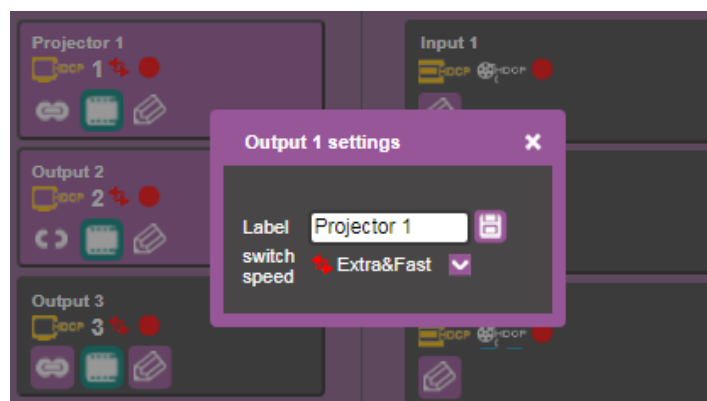



Figure 15: Switching Page – Changing the Output Label

5. Click **switch speed** dropdown box to set the switching speed (normal, fast or extra-fast).

6. Click  to mute or  to unmute the video signal.

7. To set the output to:

- AFV mode, click .
- Breakaway mode, click .

 indicates that the device is in the auto-switch mode and AFV status cannot be altered.

 Setting the AFV mode icons to AFV or Breakaway modes reflects the next switching step and not the current status.

Output settings are adjusted.

Viewing and Adjusting the Input Settings

You can view the status of the inputs and adjust their settings via the input buttons.



Figure 16: Switching Page – Input Button

Each input button displays the:

- Input signal HDCP status – supports HDCP (HDCP icon) or does not support HDCP (HDCP icon).
- HDCP status – HDCP is enabled (HDCP icon) or disabled (HDCP icon).
- Input status – a source is connected (green circle) or not connected (red circle) to the input.

Setting Input Parameters

To change input settings:

1. In the Navigation pane, click **Switching**. The Switching page appears.
2. Click the **AFV** tab. Verify that **Inputs** (and not **Patterns**) is selected.
3. Click . The input settings window appears:

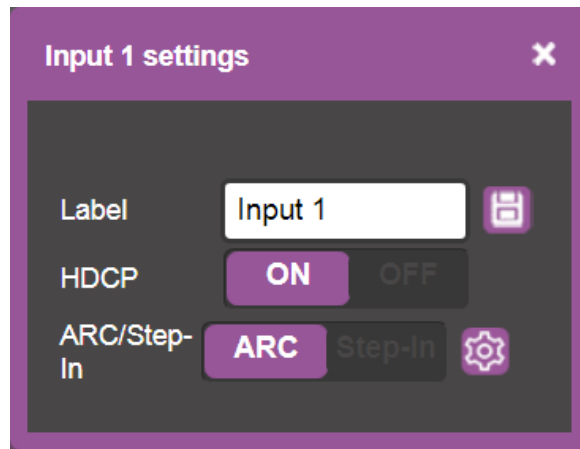

Figure 17: Switching Page – Input 1 Settings Window

4. If required, type the label name in the **Label** text box and click .
5. Set HDCP **ON** or **OFF**.
6. Click **ARC** to set input to ARC mode or click **Step-in** to set input to Step-in mode (default) when switching ARC to an input (see page [30](#)).

7. In ARC mode click the settings button (⚙️). The input ARC Settings window appears:

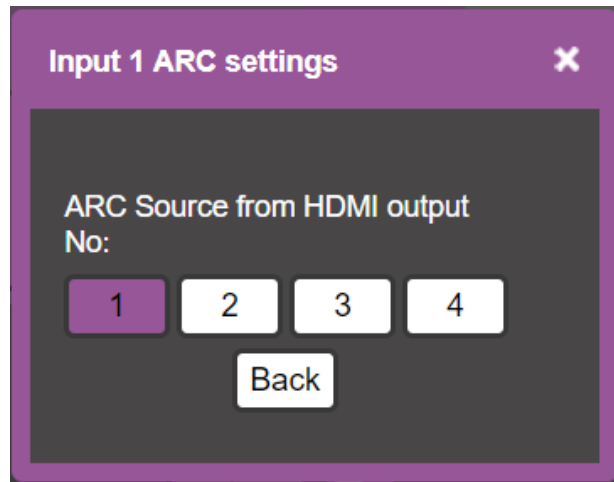

Figure 18: Switching Page – Input ARC Settings Window

8. Select an ARC source for input 1 from HDMI outputs 1 to 4. The selected port routes its audio signal to HDMI input 1.

Input settings are adjusted.

Switching an Input to an Output

To switch an input to an output:

1. In the Navigation pane, click **Switching**. The Switching page appears.
2. Click the **AFV** tab.

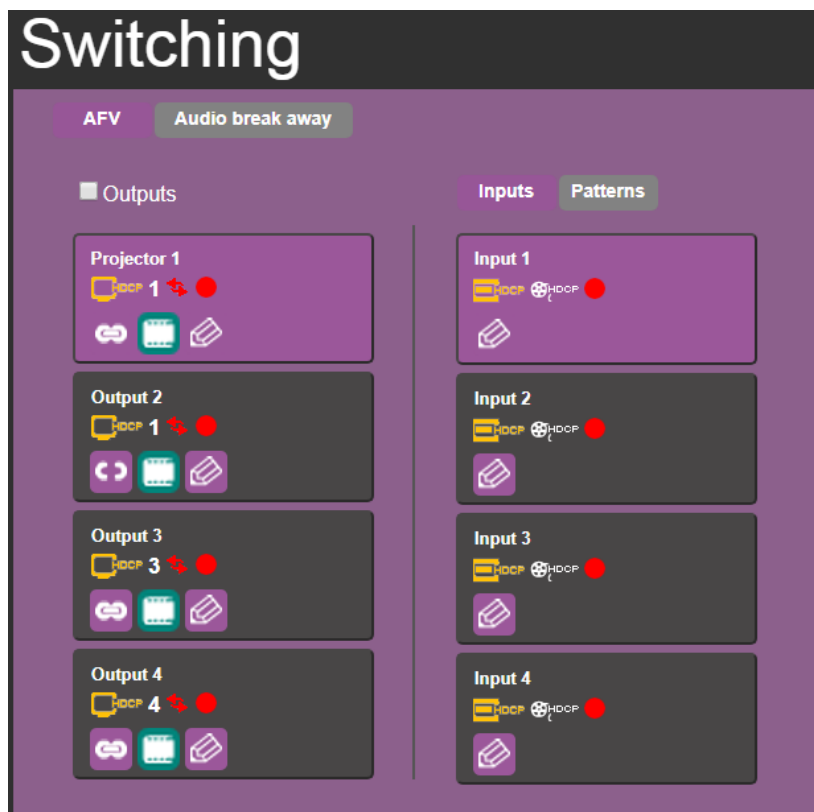

Figure 19: Switching Page – AFV Tab

3. Click an output button or check the **Outputs** box. The button turns purple.
4. Click an input button. The button turns purple.

The selected input is switched to the output.

Switching a Pattern to an Output

To switch a pattern to an output:

1. In the Navigation pane, click **Switching**. The Switching page appears.
2. Click the **AFV** tab.
3. Click **Patterns**. The list of patterns appears.



Figure 20: Switching Page – Switching a Pattern to an Output

4. Select an output button or check the **Outputs** box.
5. Select a pattern.

The selected pattern is switched to the selected output.

Switching Audio in Breakaway Mode

In breakaway mode, the HDMI embedded audio is switched separately from the video signal.



The audio breakaway mode is enabled only when Auto Switch Setting is set to Manual mode.

You can switch a digital audio input to a digital audio output independently. If HDMI input port and HDMI output port ARC mode are enabled, you can switch a selected HDMI output port ARC to any HDMI input port ARC.

To switch an audio input to an audio output in the Breakaway mode:

1. In the Navigation pane, click **Switching**. The Switching page appears.
2. Select **Audio break away** tab.

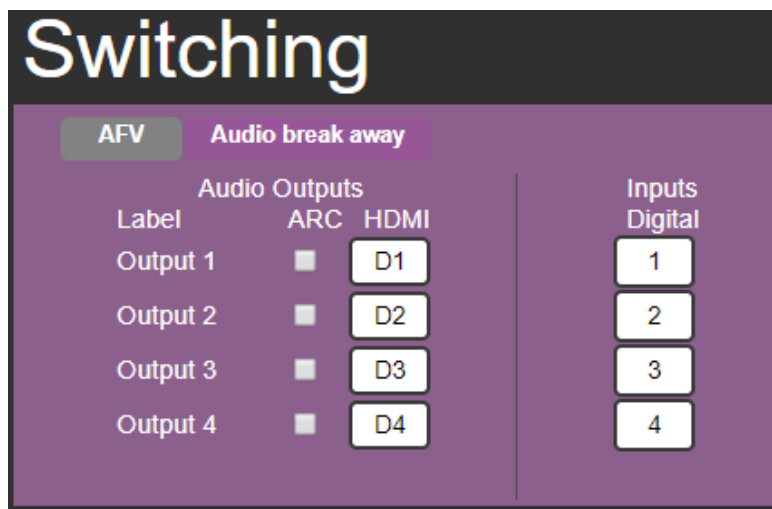

Figure 21: Switching Page – Switching Audio in the Breakaway Mode

3. Switch an input to a selected output. For example, switch digital input 4 to output 2:
 - Click **HDMI** button D2 (under the **Audio Outputs** column, which shows the current input switched to that output). The selected button turns purple.

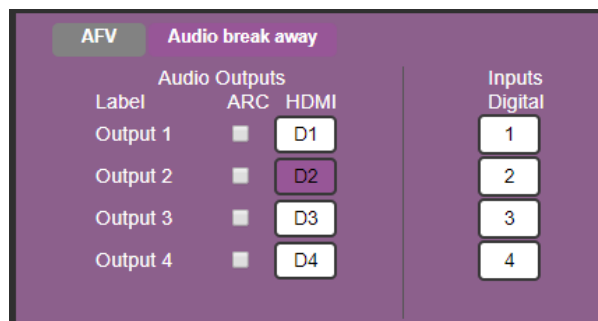

Figure 22: Switching Page – Switching Audio Signals, Selecting an Output

- Click button 4 under **Inputs Digital**. The selected button turns purple.

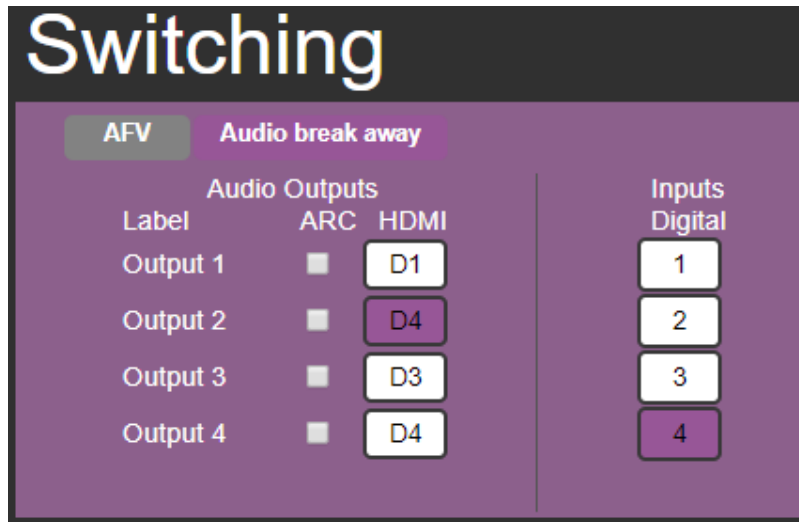

Figure 23: Switching Page – Switching Audio Signals, Selecting an Input

The selected input is switched to the output (digital input 4 is switched to output 2).

To switch ARC to an input:

1. In the Navigation pane, click **Switching**. The Switching page appears.
2. Select **Audio break away** tab.
3. Check the ARC check boxes to ARC-enable selected outputs (under the **Audio Outputs** column). For example, Output 1 and 3 are checked, therefore ARC-enabled so they can be switched as ARC signals.

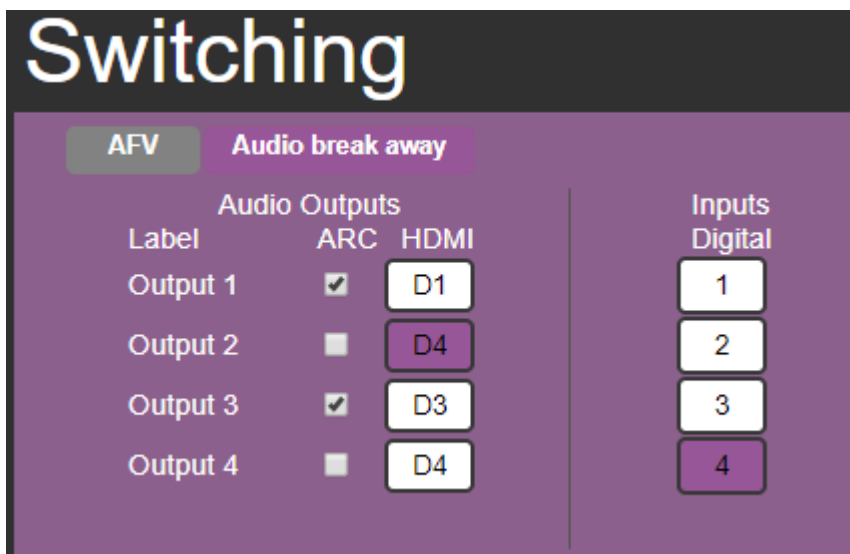

Figure 24: Switching Page – Outputs 1 and 3 ARC-Enabled

4. Select AFV tab.
5. Select an input button, for example, Input 1.

6. Click  on the input 1 button and set to **ARC** mode. This input is now ARC-enabled.

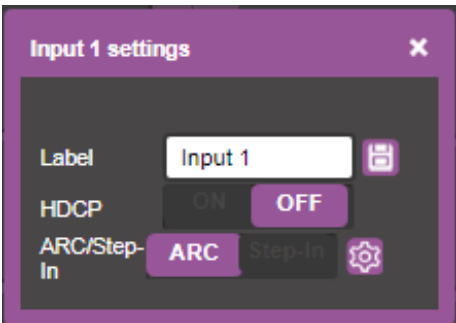

Figure 25: Switching Page – Output 1 Set to ARC Mode

7. Click  and set either output 1 or output 3 to set them as an ARC to input 1.

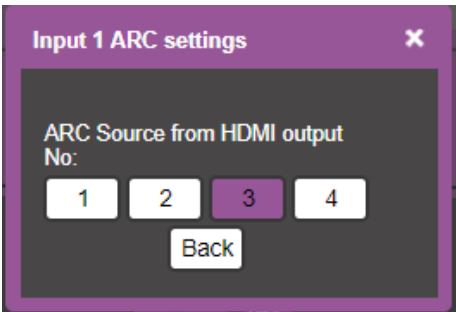

Figure 26: Switching Page – Routing Output 3 ARC to Input 1

8. Click **Back**.

Output 3 ARC is routed to input 1.

Changing Device Settings and Upgrading the Firmware

The Device Settings web page shows the device details, such as name, MAC address and firmware version and also enables performing the following functions:

- [Changing the Ethernet Settings](#) on page [32](#).
- [Performing a Factory Reset](#) on page [33](#).
- [Performing Firmware Upgrade](#) on page [33](#).

Changing the Ethernet Settings

To change the Ethernet settings:

1. In the Navigation pane, click **Device Settings**. The Device Settings page appears:

Figure 27: Device Settings Page

2. Uncheck/check the **DHCP** check box.
3. If DHCP is not checked, change any of the parameters (IP Address, Netmask and/or Gateway).
- 4 . Click **Save Changes**.



Note that:

- After changing the IP address, you need to reload the web page with the new IP address.
- After changing the subnet mask you need to turn the **VS-44UHD** power off and then on again.
- If DHCP is checked, you need to reload the web page with the new IP address.

Performing a Factory Reset

To reset the device to its factory default values:

1. In the Navigation pane, click **Device Settings**. The Device Settings page appears ([Figure 27](#)).
2. Click **Reset**. The following window appears:

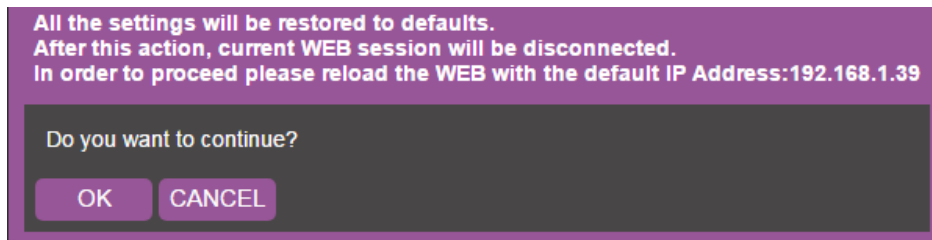

Figure 28: Device Settings Page – Factory Reset

3. Click **OK** to start factory reset and follow the instructions on-screen.

The device resets to its default parameters.

Performing Firmware Upgrade

To perform firmware upgrade:

1. In the Navigation pane, click **Device Settings**. The Device Settings page appears ([Figure 27](#)).
2. Click **BROWSE** and select the new firmware file.
3. Click **START UPGRADE** and follow the instructions on-screen.

The new firmware reloads.

Managing Web Page Security

Use the Authentication page to set web access permission:

Setting Web Page Access Permission

To define access to the web pages In the Navigation pane, click **Authentication**. The Authentication page appears displaying the current status (password protected or free access).

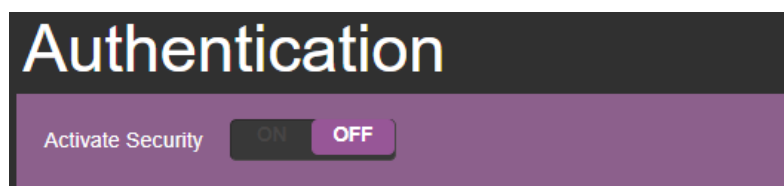

Figure 29: Authentication Page – Security ON (by-default)

To access web pages without using the password:

1. Check the current security settings.

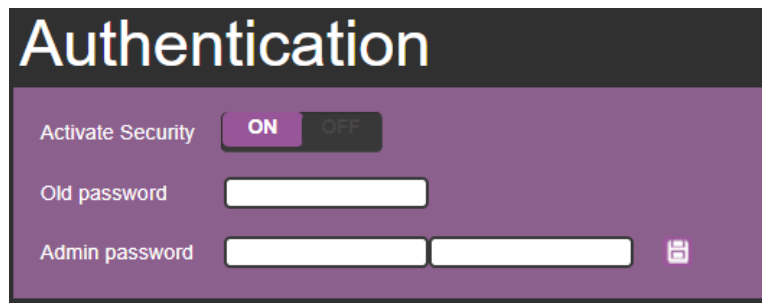

Figure 30: Authentication Page – Password Protected

2. Set **Activate Security** to **OFF**. The following message appears:

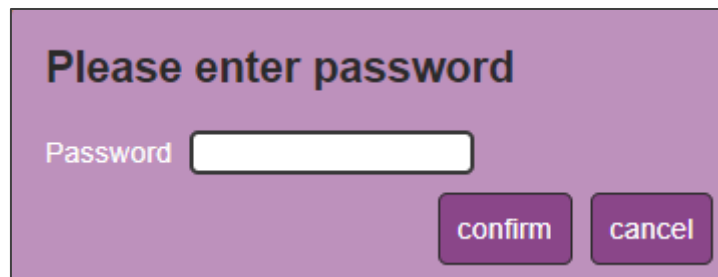

Figure 31: Authentication Page – Deactivating the Security

3. Enter the current password and click **confirm**. A confirmation message appears:
4. Click **OK**.
The web page reloads.

The web pages are no longer password protected.

To access web pages using a password:

1. Check the current security status.

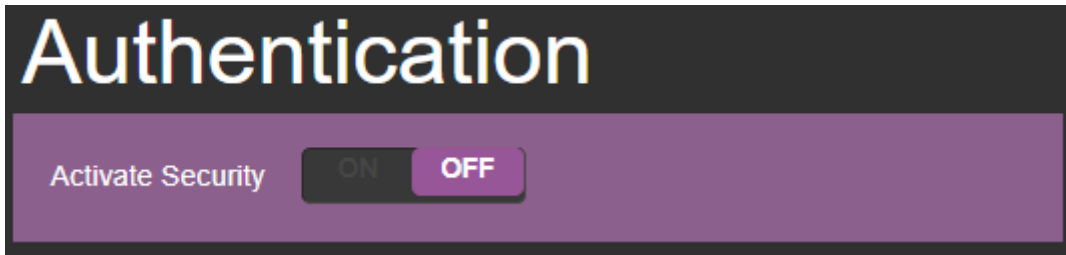

Figure 32: Authentication Page – Security OFF

2. Set **Activate Security** to **ON** for web page password protection. The following message appears:

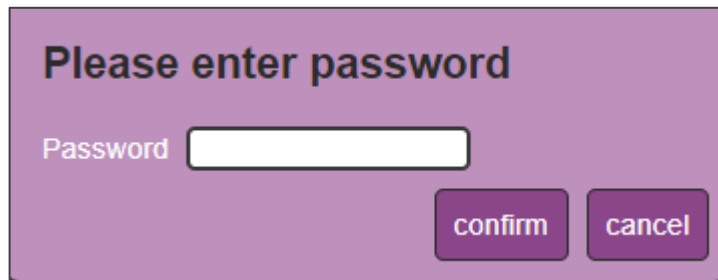

Figure 33: Authentication Page – Entering Password



By default, Admin password is an empty string. When activating security for the first time, you can change the password.

3. Click **confirm**. A confirmation message appears.
4. Click **OK**.
The page refreshes.
5. If required, change the password.

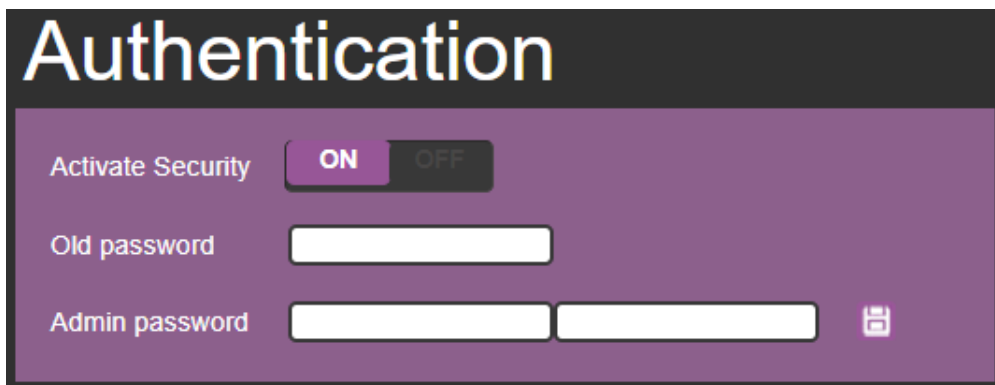



Figure 34: Authentication Page – Changing the Password

6. Click .
A confirmation message appears.

7. Click **OK**.

The connection is interrupted and authentication is required to access web pages.

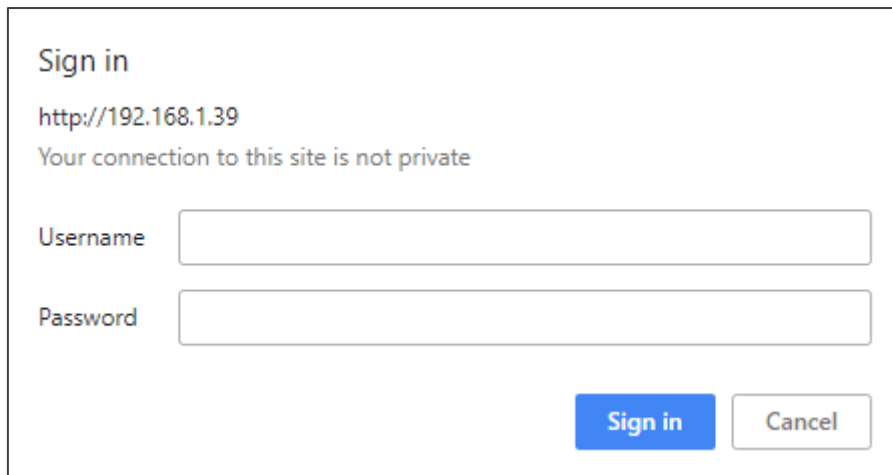

Figure 35: Authentication Page – Security Sign In

8. Type the User Name (Admin, by default) and Password (left empty by default).

9. Click **Sign in**.

The web pages are password protected.

Setting the Timeout

Use the **Timeout Settings** web page to set the time delay before shutdown if no input signal is detected for each output and also to set the auto switching time.



Always set the timeout period (5V cut-off) delay to be longer than the **Video signal loss timer** delay.

To set the timeout:

1. In the Navigation pane, click **Timeout Settings**. The Timeout Settings page appears.

Figure 36: Timeout Settings Page

2. Set the delay time for each output.



If you do not want a specific output to shut down when an input signal is not detected, check the **Never** box next to that output.

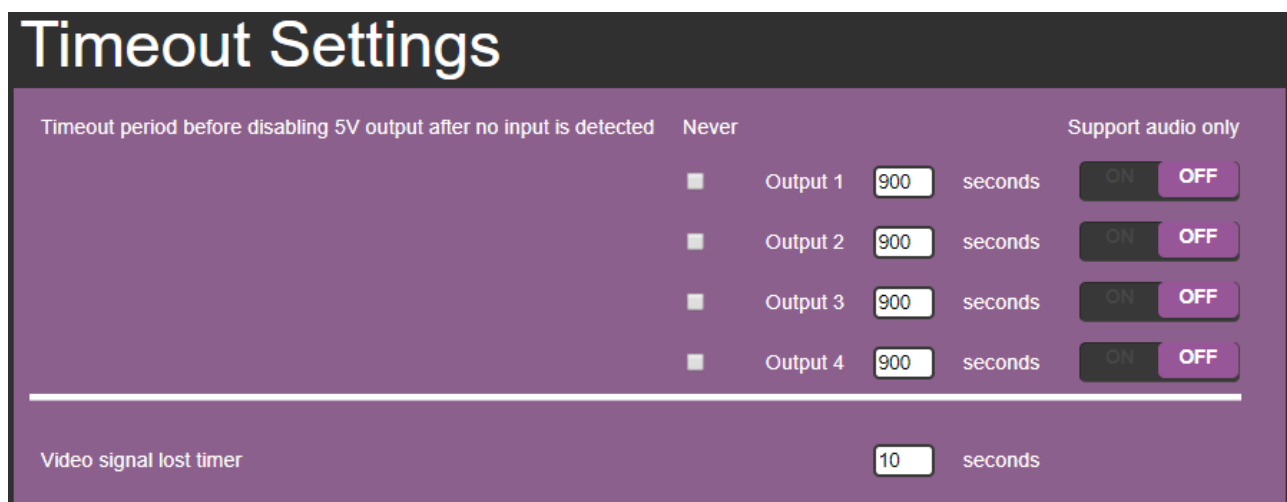
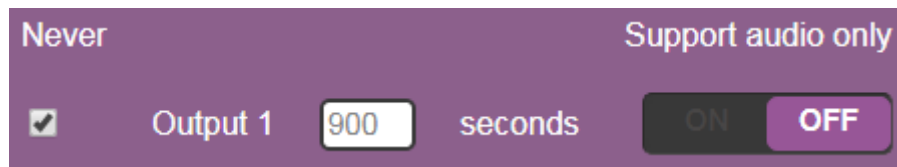

3. Set audio support **ON** if you want shutdown to occur only if an audio signal is lost.



Support audio only can be used if the video and audio signals routed to an output, come from separate sources.

If Support audio only is set to:

- **ON** – The audio signal routed to the output remains active when the video source (coming from a different input) is deactivated.
- **OFF** – The audio signal routed to the output is deactivated together with the deactivation of the video source (coming from a different input).

Timeout settings are complete.

To set the video lost timer (when in auto-switching mode):

1. In the Navigation pane, click **Timeout Settings**. The Timeout Settings page appears.
2. Set the video lost timer.

Video lost timer settings are complete.



The adjustment sequence presented here is only an example. You can adjust the output settings in any other order.



If the video is lost when in the auto switching mode (Priority or Last connected) you can set the time the device waits before it switches to the next source.

Setting Switching Modes

Use the **Auto Switch Settings** page to set the switching mode per output.

 Setting to priority or last connected mode forces **VS-44UHD** to operate in AFV mode.

To set the switching mode:

1. In the Navigation pane, click **Auto Switch Settings**. The Auto Switch Settings page appears.

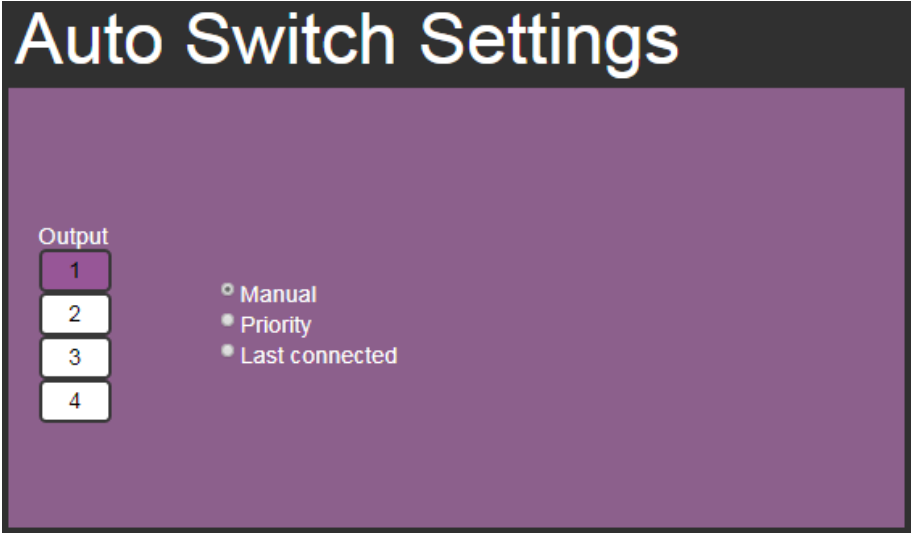

Figure 37: Auto Switch Settings Page

2. Select an output and set the switching mode to **Manual**, **Priority** or **Last connected**:
 - In the Manual mode (see [Figure 37](#)), the outputs are switched manually to the selected output.
 - In the Priority mode, drag and drop the inputs from the highest to the lowest priority. The inputs are then switched to the selected output according to the set priority:

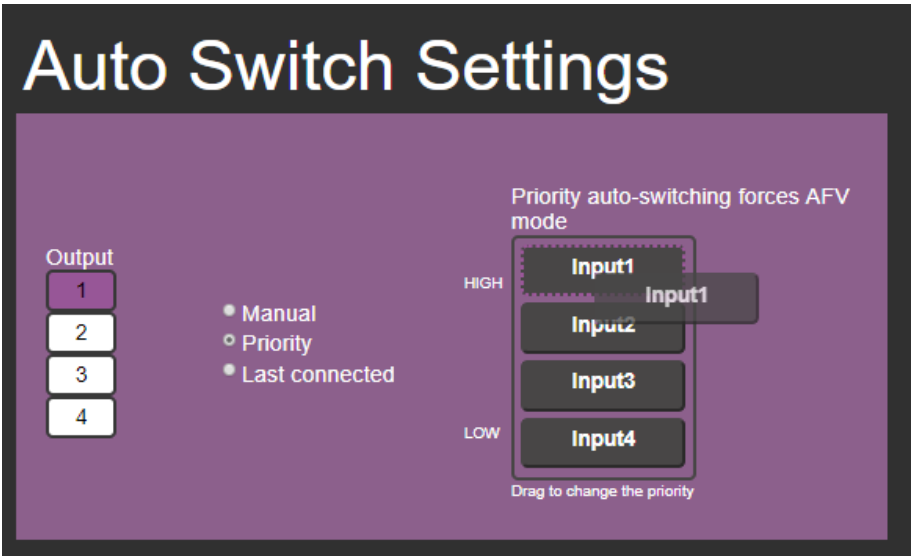

Figure 38: Auto Switch Settings Page – Setting the Switching Priority

- In the Last connected mode, select the inputs that are included in the last connected scan that will be switched to the selected output:

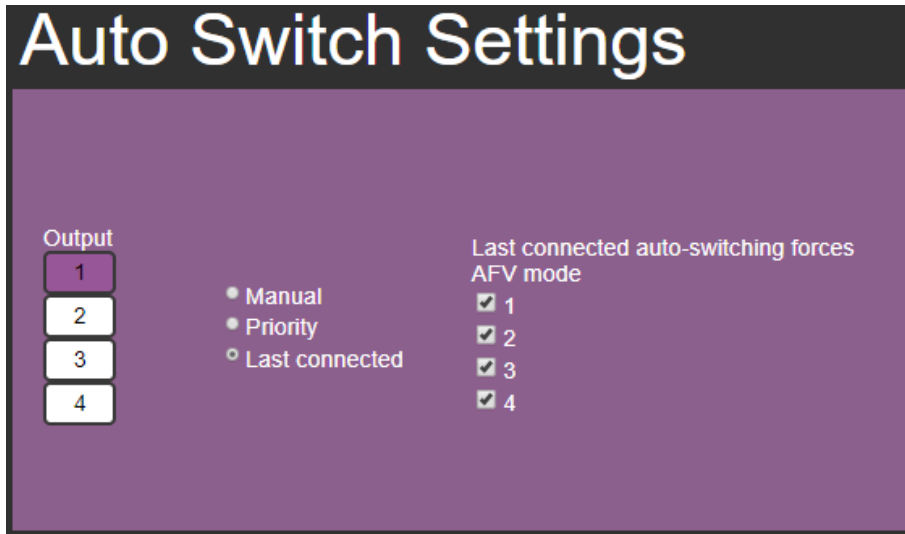

Figure 39: Auto Switch Settings Page – Last Connected Mode

Auto-switch settings are complete.

Setting Step-In Devices

Use the Step-In Settings page to manage Step-in devices (for example, Kramer **DIP-30**).

If a Step-in device is not connected to **VS-44UHD**, the following page appears:

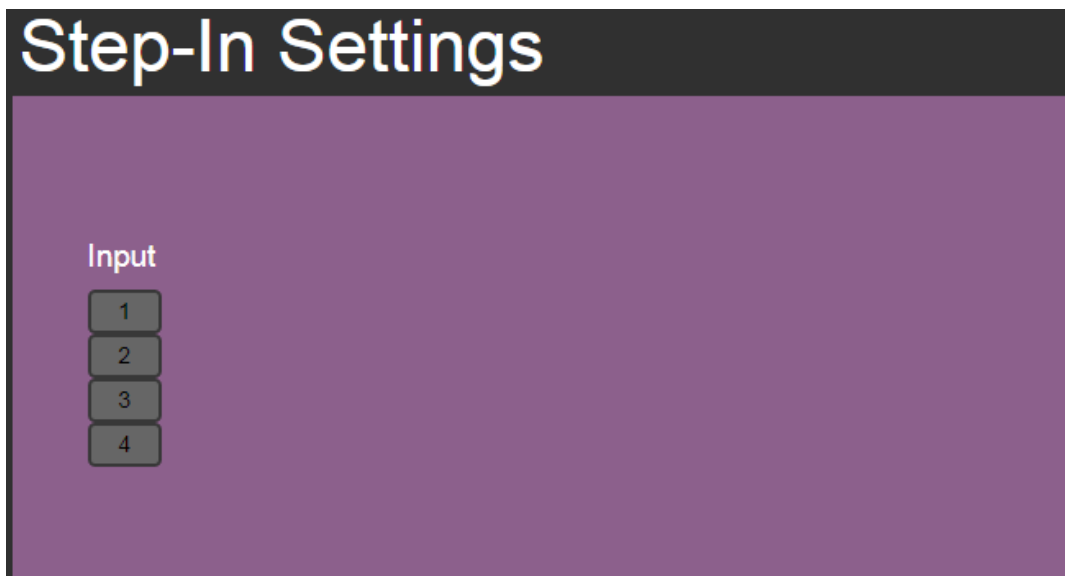

Figure 40: Step-In Settings Page (Step-in Device is not Connected)

To manage a Step-in device:

1. Connect the HDMI output of a Step-in device (for example, **DIP-30**) to an HDMI input on the **VS-44UHD**.
2. In the Navigation pane, click **Step-In Settings**. The Step-In Settings page appears and the input button/s to which the Step-in device/s is connected appear/s purple. The **DIP-30** Inputs list and the **VS-44UHD** outputs to which the **DIP-30** input is routed are displayed:

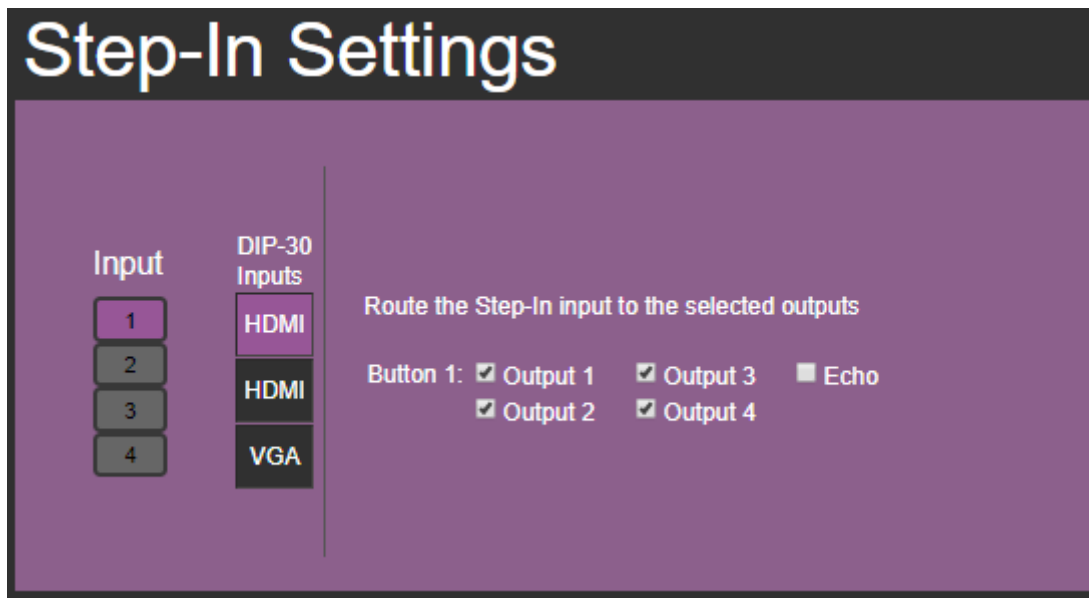

Figure 41: Step-In Settings Page – Displaying Step-In Inputs

3. Select a **DIP-30** input (HDMI IN 1, HDMI IN 2 or VGA). The respective button on **DIP-30** illuminates.



You can also press an input button on the **DIP-30**. The selected input will be displayed on the web page.

4. Check the outputs to which the inputs will be routed.
5. Press the **STEP-IN** button on **DIP-30**. The selected Step-in button is routed to all the checked outputs.



Any time the output Step-in configuration changes, press the STEP-IN button on the Step-in device to update the configuration.



Selecting Echo sends an instruction via the **VS-44UHD** RS-232 port.

The selected Step-in input on the **DIP-30** is routed to the selected outputs on the **VS-44UHD**.

Managing the EDID

The EDID Management page lets you read the EDID from:

- Any of the outputs.
- The default EDID.
- Any of the inputs.
- A file in your PC (File BROWSE).

The selected EDID can be copied to the selected input/s.

To copy an EDID from an output to an input:

1. In the Navigation pane, click **EDID Management**. The EDID Management page appears.

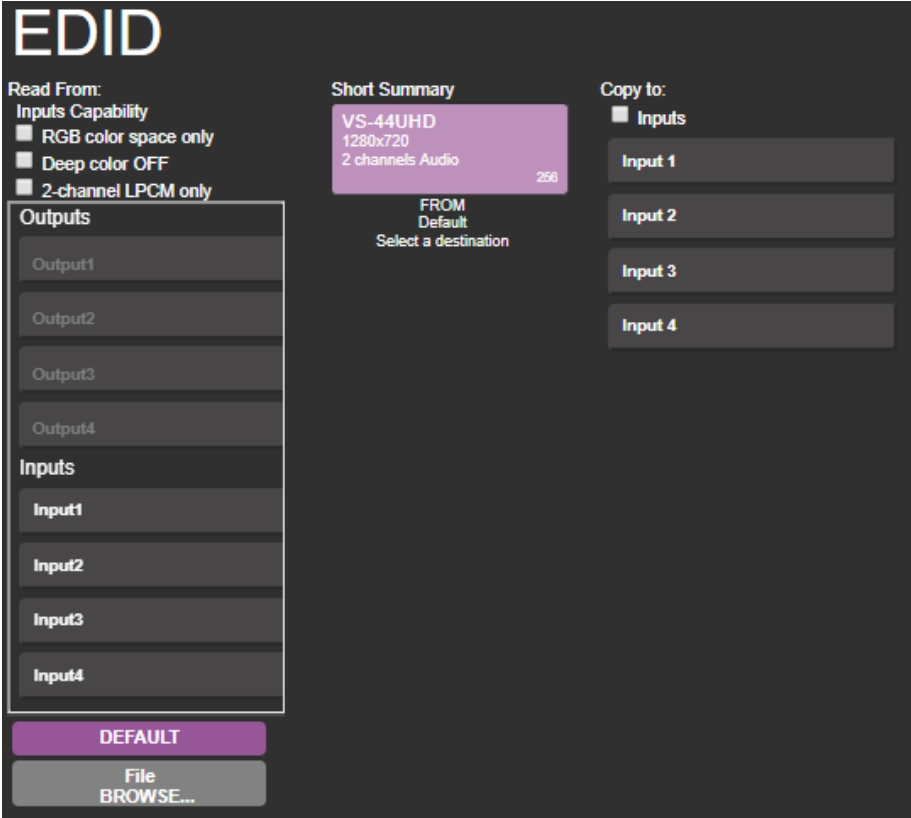

Figure 42: EDID Management Page – Selecting an EDID Source

2. Select the EDID source: a connected output.



When reading from an output, make sure that that output is connected to an acceptor.

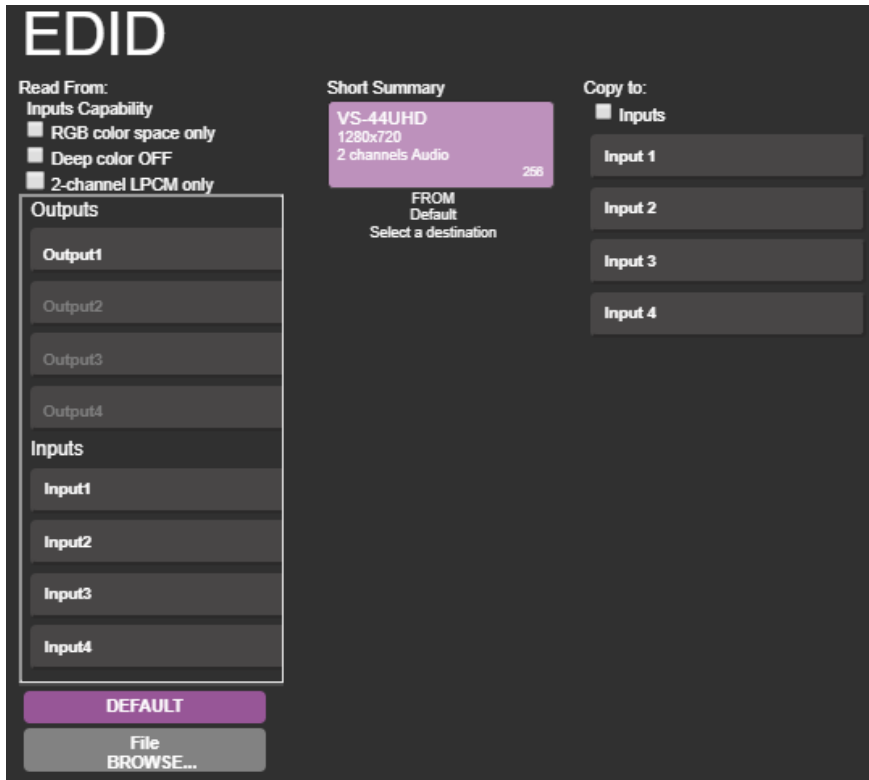

Figure 43: EDID Management Page – Selecting an EDID Output

3. Select an input (or all the inputs) to which the EDID is copied.

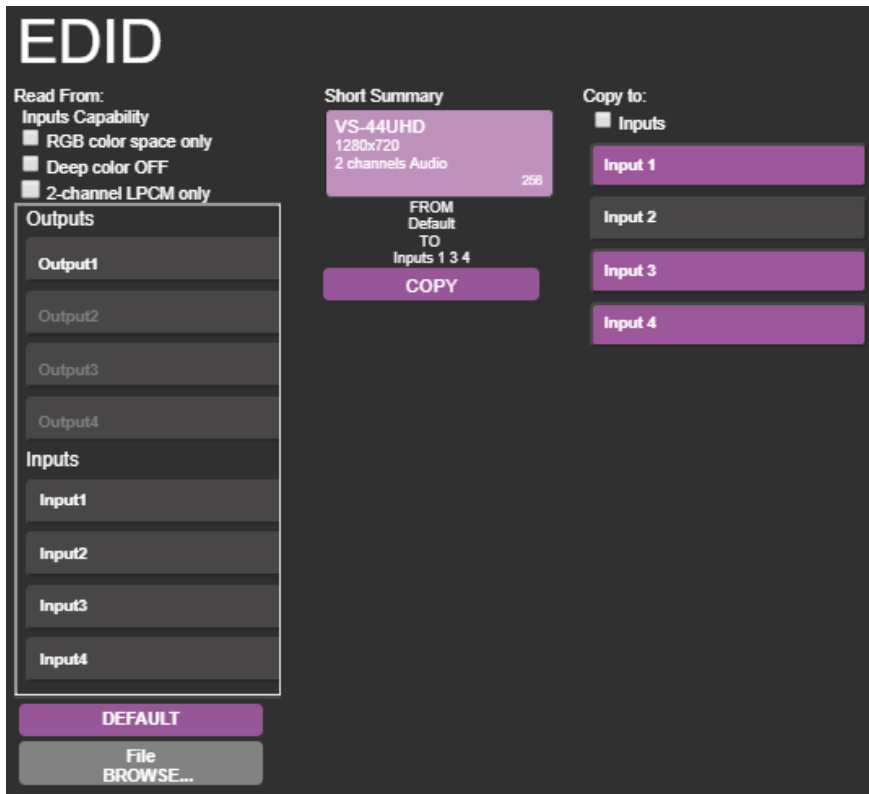

Figure 44: EDID Management Page – Selecting an Input

- Click **COPY**. A message appears.

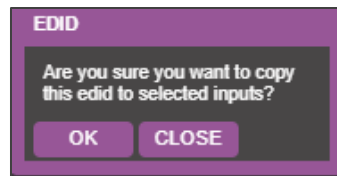

Figure 45: EDID Page –EDID Copy Message

- Click **OK**. A confirmation message appears.
- Click **OK**.

To read the EDID from the default EDID:

- In the Navigation pane, click **EDID Management**. The EDID Management page appears.
- Click **DEFAULT**.
- Click **OK** and follow the instructions on-screen.

To read the EDID from an input to another input/s:

- In the Navigation pane, click **EDID Management**. The EDID Management page appears.
- Select an input from the list (on the left).
- If required, check the options under **Inputs Capability**.

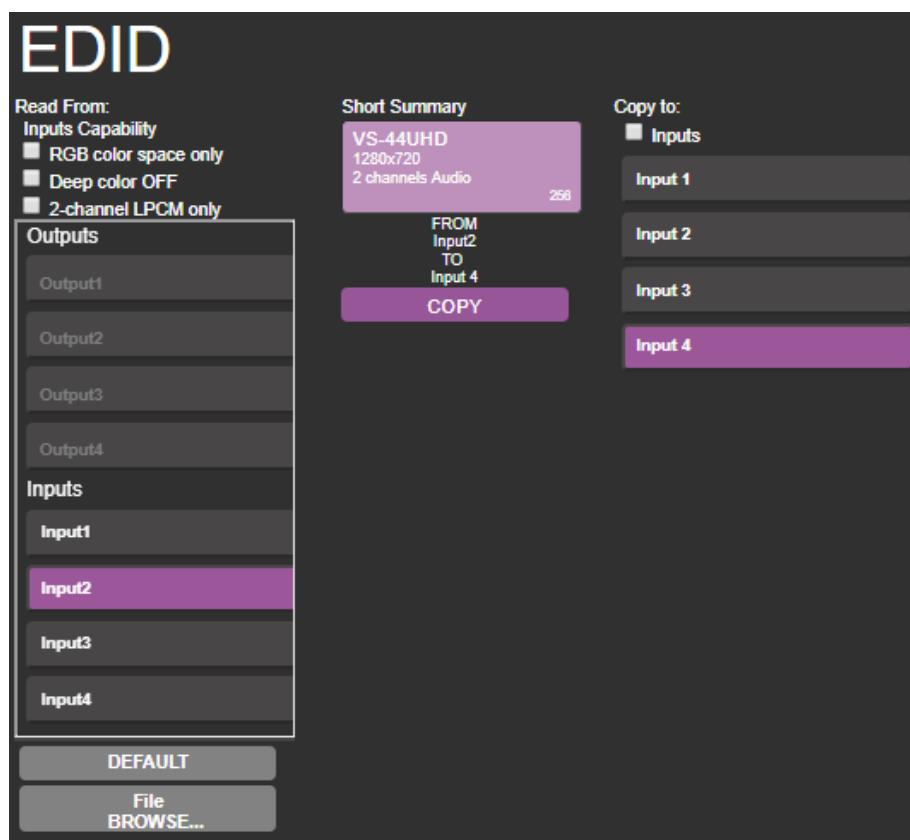

Figure 46: EDID Management Page – Copying EDID from Input to Input

- Click **COPY** and follow the instructions on-screen.

The EDID is loaded to the selected inputs.

To read the EDID from a file:

- 1. In the Navigation pane, click **EDID Management**. The EDID Management page appears.
- 2. Click **File BROWSE** and open the EDID file.

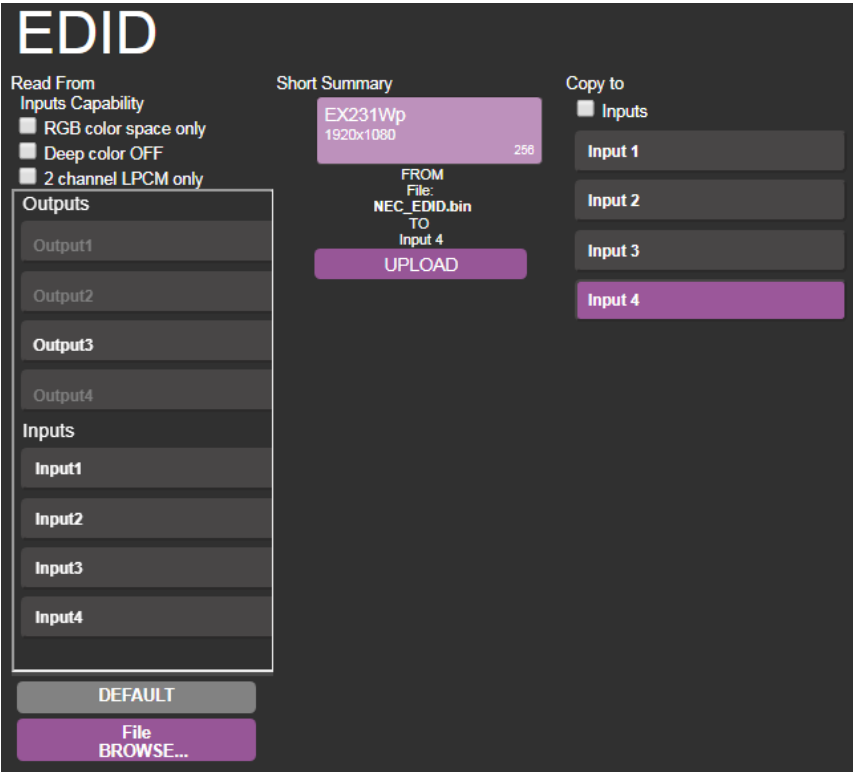

Figure 47: EDID Management Page – Selecting EDID from a File

- 3. Select one or more inputs.

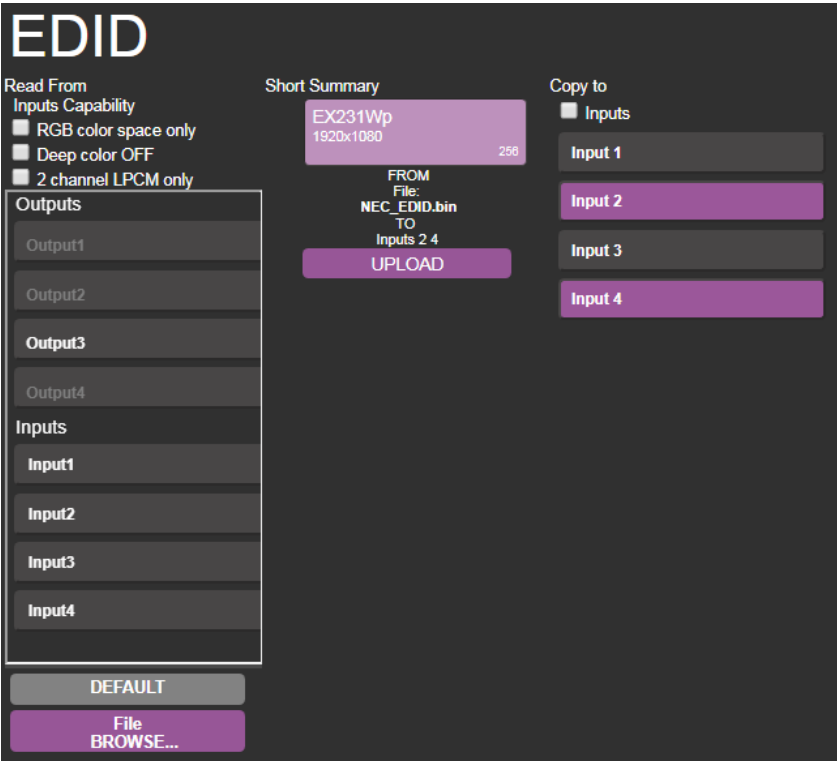

Figure 48: EDID Management Page – Uploading EDID from a File to the Input

- Click **UPLOAD**. The following message appears:

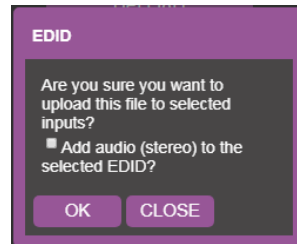

Figure 49: EDID Management Page – EDID Message

- If required, Check adding stereo audio to the selected EDID.
- Click **OK**.
- Follow the instructions on-screen.



When viewing the 7-segment display in the EDID mode, the input with EDID read from a file displays "L".

Viewing the About Us Page

The VS-44UHD About Us page lets you view the web page version and Kramer Electronics Ltd details.



Figure 50: About Page

Technical Specifications

Inputs	4 HDMI	On female HDMI connectors
Outputs	4 HDMI	On female HDMI connectors
Ports	1 USB	On a mini USB connector
	1 RS-232	On a 3-pin terminal block
	1 Ethernet	On an RJ-45 female connector
	1 USB	On a female USB-A connector for powering another device
Video	Max. Resolution	4K@60Hz (4:2:0) and 4K@30Hz (4:4:4)
	Compliance	Supports HDMI 1.4 and HDCP 1.4
Control	Front Panel	Front panel buttons
		7-segment display
Power	Consumption	42VA
	Source	100-240V AC, 50/60Hz
Regulatory Compliance	Safety	CE, FCC
	Environmental	RoHs, WEEE
Enclosure	Type	Aluminum
	Cooling	Fan
Environmental Conditions	Operating Temperature	0° to +40°C (32° to 104°F)
	Storage Temperature	-40° to +70°C (-40° to 158°F)
	Humidity	10% to 90%, RH non-condensing
General	Net Dimensions (W, D, H)	19", 7.2", 1U, rack mountable
	Shipping Dimensions (W, D, H)	52.5cm x 33cm x 10.7cm (20.7" x 13" x 4.2")
	Net Weight	1.9kg (4.2lbs) approx.
	Shipping Weight	2.9kg (6.39lbs) approx.
Accessories	Included	Rack ears, power cord
Specifications are subject to change without notice at www.kramerav.com		

The terms HDMI, HDMI High-Definition Multimedia Interface, and the HDMI Logo are trademarks or registered trademarks of HDMI Licensing Administrator, Inc.

Default Communication Parameters

RS-232/Ethernet			
Baud Rate:	115,200	Parity:	None
Data Bits:	8	Command Format:	ASCII Protocol 3000
Stop Bits:	1		
Example (route video HDMI IN 2 to video HDMI OUT 4):			"#ROUTE 1,4,2",0x0D
Ethernet Parameters			
IP Address:	192.168.1.39	Default TCP Port #:	5000
Subnet Mask:	255.255.0.0	Default UDP Port #:	50000
Default Gateway:	192.168.0.1	Number of TCP ports:	8
		Number of web clients:	5

Full Factory Reset	
Front Panel Buttons:	Power off the device, press and hold the LOCK, EDID and STO buttons simultaneously for about 3 seconds while powering the device, and then release. Until all front panel buttons illuminate
Protocol 3000:	"#factory" command.
Web Pages:	In the Device Settings page, click Reset.

Default Parameters

Parameter	Value
Protocol:	K3000
K3000 Model Name:	V', 'S', '-', '4', '4', 'U', 'H', 'D'"
K3000 Serial Number:	00000000000001
 Model name and serial number will not change back to the default status after a factory reset.	
DHCP enable:	Disable(OFF)
EDID status:	Default, all input ports use the default EDID data.
Input port HDCP:	All ON, support HDCP.
Step-in button setting:	Default, all the output checked for an input.
Video status:	Output 1 to 4 route to input 1 to 4 separately.
Audio status:	Output 1 to 4 route to digital input 1 to 4 separately.
All setups:	All empty. No preset status.
EDID data:	All input ports use the default EDID data.
V-mute:	Open the video.
Mute:	Open the audio.
Switch mode:	Manual.
Switch speed:	Ex-fast switch.
ARC or de-embedded:	De-embedded.
Video Priority settings	Lower input index has higher priority.
Auto Switching mode	Priority order is highest for 1 and lowest for 4
Auto Switching settings	All video inputs are routed to each of the video outputs
Default EDID	Kramer default EDID with "monitor name"="VS-44UHD"
Lock EDID state	Not locked
HDCP mode	ENABLED
Video Signal loss timeout (no 5V)	0
Video Signal loss timeout (5V is on)	10 sec
New video signal gain timeout	0
Output inactivity timeout	15 min
Apply switch mode configuration on startup	10

Protocol 3000

The VS-44UHD 4x4 UHD Matrix Switcher can be operated using the Kramer Protocol 3000 serial commands. The command framing varies according to how you interface with the VS-44UHD.

Generally, a basic video input switching command that routes a layer 1 video signal to HDMI out 1 from HDMI input 2 (ROUTE 1, 1, 2), is entered as follows:

- Terminal communication software, such as Hercules:

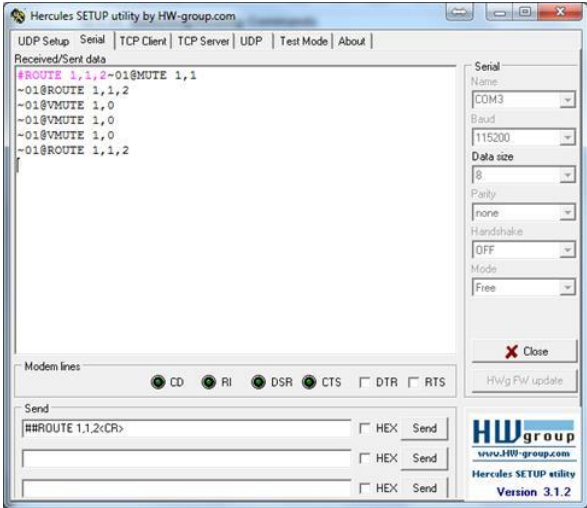

 The framing of the command varies according to the terminal communication software.

- K-Touch Builder (Kramer software):

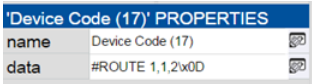

- K-Config (Kramer configuration software):



 All the examples provided in this section are based on using the K-Config software.

You can enter commands directly using terminal communication software (e.g., Hercules) by connecting a PC to the serial or Ethernet port on the VS-44UHD. To enter `CR` press the Enter key (`LF` is also sent but is ignored by the command parser).

Commands sent from various non-Kramer controllers (e.g., Crestron) may require special coding for some characters (such as, /X# #). For more information, refer to your controller’s documentation.

For more information about Protocol 3000 commands, see:

- [Understanding Protocol 3000](#) on page [49](#).
- [Kramer Protocol 3000 Syntax](#) on page [50](#).
- [Protocol 3000 Commands](#) on page [51](#).

Understanding Protocol 3000

Protocol 3000 commands are structured according to the following:

- **Command** – A sequence of ASCII letters (A-Z, a-z and -). A command and its parameters must be separated by at least one space.
- **Parameters** – A sequence of alphanumeric ASCII characters (0-9, A-Z, a-z and some special characters for specific commands). Parameters are separated by commas.
- **Message string** – Every command entered as part of a message string begins with a message starting character and ends with a message closing character.



A string can contain more than one command. Commands are separated by a pipe (|) character.

- **Message starting character:**
 - # – For host command/query
 - ~ – For device response
- **Device address** – K-NET Device ID followed by @ (optional, K-NET only)
- **Query sign** – ? follows some commands to define a query request
- **Message closing character:**
 - `CR` – Carriage return for host messages (ASCII 13)
 - `CR LF` – Carriage return for device messages (ASCII 13) and line-feed (ASCII 10)
- **Command chain separator character** – Multiple commands can be chained in the same string. Each command is delimited by a pipe character (|). When chaining commands, enter the message starting character and the message closing character only at the beginning and end of the string.



Spaces between parameters or command terms are ignored. Commands in the string do not execute until the closing character is entered. A separate response is sent for every command in the chain.

Kramer Protocol 3000 Syntax

The Kramer Protocol 3000 syntax uses the following delimiters:

- **CR** = Carriage return (ASCII 13 = 0x0D)
- **LF** = Line feed (ASCII 10 = 0x0A)
- **SP** = Space (ASCII 32 = 0x20)

Some commands have short name syntax in addition to long name syntax to enable faster typing. The response is always in long syntax.

The Protocol 3000 syntax is in the following format:

- **Host Message Format:**

Start	Address (optional)	Body	Delimiter
#	<i>Device_id@</i>	Message	CR

- **Simple Command** – Command string with only one command without addressing:

Start	Body	Delimiter
#	Command SP <i>Parameter_1,Parameter_2,...</i>	CR

- **Command String** – Formal syntax with command concatenation and addressing:

Start	Address	Body	Delimiter
#	<i>Device_id@</i>	Command_1 <i>Parameter1_1,Parameter1_2,... </i> Command_2 <i>Parameter2_1,Parameter2_2,... </i> Command_3 <i>Parameter3_1,Parameter3_2,... ...</i>	CR

- **Device Message Format:**

Start	Address (optional)	Body	Delimiter
~	<i>Device_id@</i>	Message	CR LF

- **Device Long Response** – Echoing command:

Start	Address (optional)	Body	Delimiter
~	<i>Device_id@</i>	Command SP [<i>Param1 ,Param2 ...</i>] result	CR LF

Protocol 3000 Commands

This section includes the following commands:

- [Common Commands](#) on page [51](#).
- [System Commands](#) on page [58](#).
- [Authentication Commands](#) on page [65](#).
- [EDID Handling Commands](#) on page [67](#).
- [Switch Commands](#) on page [68](#).
- [Switching Commands](#) on page [71](#).
- [Communication Commands](#) on page [72](#).

Common Commands

Command	Description
#	Protocol handshaking (system mandatory)
BUILD-DATE	Get device build date (system mandatory)
FACTORY	Reset to factory default configuration
HELP	Get command list (system mandatory)
MODEL?	Get device model (system mandatory)
PROT-VER?	Get device protocol version (system mandatory)
RESET	Reset device (system mandatory)
SN?	Get device serial number (system mandatory)
VERSION?	Read device firmware version
IDV	Set visual indication from device
LOCK-FP	Lock/get front panel
NAME	Set/get machine (DNS) name
NAME-RST	Reset machine name to factory default (DNS)

#

Functions		Permission	Transparency
Set:	#	End User	Public
Get:	-	-	-
Description		Syntax	
Set:	Protocol handshaking	# <code>CR</code>	
Get:	-	-	
Response			
~nn@SPOR <code>CR</code> LF			
Notes			
Validates the Protocol 3000 connection and gets the machine number. Step-in master products use this command to identify the availability of a device.			
K-Config Example			
`#`, 0x0D			

BUILD-DATE

Functions		Permission	Transparency
Set:	-	-	-
Get:	BUILD-DATE?	End User	Public
Description		Syntax	
Set:	-	-	
Get:	Get device build date	# BUILD-DATE? <code>CR</code>	
Response			
~nn@ BUILD-DATE <code>SP</code> date <code>SP</code> time <code>CR LF</code>			
Parameters			
<i>date</i> – Format: YYYY/MM/DD where YYYY (Year), MM (Month), DD (Day)			
<i>time</i> – Format: hh:mm:ss where hh (Hours), mm (Minutes), ss (Seconds)			
K-Config Example			
"#BUILD-DATE?", 0x0D			

FACTORY

Functions		Permission	Transparency
Set:	FACTORY	End User	Public
Get:	-	-	-
Description		Syntax	
Set:	Reset device to factory default configuration	# FACTORY <code>CR</code>	
Get:	-	-	
Response			
~nn@ FACTORY <code>SP</code> OK <code>CR LF</code>			
Notes			
This command deletes all user data from the device. The deletion can take some time. Your device may require powering off and powering on for the changes to take effect.			
K-Config Example			
"#FACTORY", 0x0D			

HELP

Functions		Permission	Transparency
Set:	-	-	-
Get:	HELP	End User	Public
Description		Syntax	
Set:	-	-	
Get:	Get command list or help for specific command	# HELP <input type="text"/>	
Response			
Multi-line: ~ <input type="text"/> @Device available protocol 3000 commands: <input type="text"/> LF <i>command</i> , <input type="text"/> SP command... <input type="text"/> CR LF			
Parameters			
<i>COMMAND_NAME</i> – name of a specific command			
Notes			
To get help for a specific command use: HELP <input type="text"/> COMMAND_NAME <input type="text"/> CR LF			
K-Config Example			
"#HELP", 0x0D			

MODEL

Functions		Permission	Transparency
Set:	-	-	-
Get:	MODEL?	End User	Public
Description		Syntax	
Set:	-	-	
Get:	Get device model	# MODEL? <input type="text"/>	
Response			
~ <input type="text"/> @ MODEL <input type="text"/> model_name <input type="text"/> CR LF			
Parameters			
<i>model_name</i> – String of up to 19 printable ASCII chars			
Notes			
This command identifies equipment connected to Step-in master products and notifies of identity changes to the connected equipment. The Matrix saves this data in memory to answer REMOTE-INFO requests.			
K-Config Example			
"#MODEL?", 0x0D			

PROT-VER

Functions		Permission	Transparency
Set:	-	-	-
Get:	PROT-VER?	End User	Public
Description		Syntax	
Set:	-	-	
Get:	Get device protocol version	# PROT-VER? <input type="checkbox"/> CR	
Response			
~nn@ PROT-VER <input type="checkbox"/> SP3000:versionCR LF			
Parameters			
version - XX.XX where X is a decimal digit			
K-Config Example			
"#PROT-VER?", 0x0D			

RESET

Functions		Permission	Transparency
Set:	RESET	Administrator	Public
Get:	-	-	-
Description		Syntax	
Set:	Reset device	# RESET <input type="checkbox"/> CR	
Get:	-	-	
Response			
~nn@ RESET <input type="checkbox"/> SPOKCR LF			
Notes			
To reset the device, first send the #FACTORY command and then send #RESET.			
To avoid locking the port due to a USB bug in Windows, disconnect USB connections immediately after running this command. If the port was locked, disconnect and reconnect the cable to reopen the port.			
K-Config Example			
"#RESET", 0x0D			

SN

Functions		Permission	Transparency
Set:	-	-	-
Get:	SN?	End User	Public
Description		Syntax	
Set:	-	-	
Get:	Get device serial number	# SN? <input type="checkbox"/> CR	
Response			
~nn@ SN <input type="checkbox"/> SPserial_numberCR LF			
Parameters			
serial_number – 11 decimal digits, factory assigned			
Notes			
This device has a 14-digit serial number, only the last 11 digits are displayed.			
K-Config Example			
"#SN?", 0x0D			

VERSION

Functions		Permission	Transparency
Set:	-	-	-
Get:	VERSION?	End User	Public
Description		Syntax	
Set:	-	-	
Get:	Get firmware version number	# VERSION? <input type="checkbox"/> CR	
Response			
~nn@ VERSION <input type="checkbox"/> SPfirmware_versionCR LF			
Parameters			
firmware_version – XX.XX.XXXX where the digit groups are: major.minor.build version			
K-Config Example			
"#VERSION?", 0x0D			

IDV

Functions		Permission	Transparency
Set:	IDV	End User	Public
Get:	-		
Description		Syntax	
Set:	Set visual indication from device	# IDV <input type="checkbox"/> CR	
Get:	-		
Response			
~nn@ IDV <input type="checkbox"/> SPOKCR LF			
Notes			
Using this command, some devices can light a sequence of buttons or LEDs to allow identification of a specific device from similar devices.			
K-Config Example			
"#IDV", 0x0D			

LOCK-FP

Functions		Permission	Transparency
Set:	LOCK-FP	End User	Public
Get:	LOCK-FP?	End User	Public
Description		Syntax	
Set:	Lock front panel	# LOCK-FP SP <i>lock_mode</i> CR	
Get:	Get front panel lock state	# LOCK-FP?	
Response			
~ nn @ LOCK-FP SP <i>lock_mode</i> SP OK CR LF			
Parameters			
<i>lock_mode</i> – 0 (Off, unlock the front panel buttons), 1 (On, lock the front panel buttons)			
K-Config Example			
Unlock front panel: `"#LOCK-FP 0",0x0D`			

NAME

Functions		Permission	Transparency
Set:	NAME	Administrator	Public
Get:	NAME?	End User	Public
Description		Syntax	
Set:	Set machine (DNS) name	# NAME SP <i>machine_name</i> CR	
Get:	Get machine (DNS) name	# NAME? CR	
Response			
Set: ~ nn @ NAME SP <i>machine_name</i> CR LF			
Get: ~ nn @ NAME SP <i>machine_name</i> CR LF			
Parameters			
<i>machine_name</i> – String of up to 14 alpha-numeric characters (can include hyphens but not at the beginning or end)			
Notes			
The machine name is not the same as the model name. The machine name is used to identify a specific machine or a network in use (with DNS feature on).			
K-Config Example			
Set the DNS name of the device to "room-442": `"#NAME room-442",0x0D`			

NAME-RST

Functions		Permission	Transparency
Set:	NAME-RST	Administrator	Public
Get:	-	-	-
Description		Syntax	
Set:	Reset machine (DNS) name to factory default	#NAME-RST <code>CR</code>	
Get:	-	-	
Response			
~nn@NAME-RST <code>SP</code> OK <code>CR LF</code>			
Notes			
Factory default of machine (DNS) name is "KRAMER_" + 4 last digits of device serial number			
K-Config Example			
Reset the machine name (S/N last digits are 0102): "#NAME-RST KRAMER_0102",0x0D			

System Commands

Command	Description
SIGNAL	Get input signal lock status
PRST-VID?	Get video connections from saved preset
PRST-STO	Store current connections to preset
PRST-RCL	Recall saved preset list
PRST-LST?	Get saved preset list
BAUD	Set/get protocol serial port baud rate
HDCP-STAT?	Get HDCP signal status
HDCP-MOD	Set/get HDCP mode
FPGA-VER?	Get current FPGA version
LABEL?	Get input/output label

SIGNAL

Functions		Permission	Transparency
Set:	-	-	-
Get	SIGNAL?	End User	Public
Description		Syntax	
Set:	-	-	
Get:	Get input signal lock status	# SIGNAL? <code>[SP]</code> <i>inp_id</i> <code>[CR]</code>	
Response			
~ <code>[nn]</code> @ SIGNAL <code>[SP]</code> <i>inp_id,status</i> <code>[CR LF]</code>			
Parameters			
<i>inp_id</i> – input number: 1 (Input)			
<i>status</i> – signal status according to signal validation: 0 (Off), 1 (On)			
Response Triggers			
After execution, a response is sent to the com port from which the Get was received A response is sent after every change in input signal status from On to Off or from Off to On			
K-Config Example			
Get the input signal lock status of IN 1: `#SIGNAL? 1",0x0D`			

PRST-VID?

Functions		Permission	Transparency
Set:	-	-	-
Get	PRST-VID?	End User	Public
Description		Syntax	
Set:	-	-	
Get:	Get video connections from saved preset	# PRST-VID? [SP]preset,out[CR] # PRST-VID? [SP]preset,*[CR]	
Response			
~nn@ PRST-VID [SP]preset,in>out[CR LF]			
~nn@ PRST-VID [SP]preset,in>1,in>2,in>3...[CR LF]			
Parameters			
<p>preset – preset number</p> <p>in – input number or 0 if disconnected</p> <p>> – connection character between in and out parameters</p> <p>out – output number or * for all outputs</p>			
Notes			
In most units, video and audio presets are stored and recalled together by commands # PRST-STO and # PRST-RCL .			
Examples			
Store current video connections and modes to preset 5	# PRST-STO 5CR	~ PRST-STO 5CR LF	
Recall video connections from preset 3	# PRCL 3CR	~ PRST-RCL 3CR LF	
Show source of video output 2 from preset 3	# PRST-VID? 3,2CR	~ PRST-VID 3, 4>2CR LF	
K-Config Example			
Get video connections from preset 3 for all outputs: `# PRST-VID? 3,*",0x0D			

PRST-STO

Functions		Permission	Transparency
Set:	PRST-STO	End User	Public
Get	-	-	-
Description		Syntax	
Set:	Store current connections, volumes and modes in preset	# PRST-STO [SP]preset[CR]	
Get:	-	-	
Response			
~nn@ PRST-STO [SP]preset[CR LF]			
Parameters			
preset – preset number: 1(OUT 1)... 4(OUT 4); 5(IN 1)...8(IN 4)			
K-Config Example			
Store preset 1: `# PRST-STO 1",0x0D			

PRST-RCL

Functions		Permission	Transparency
Set:	PRST-RCL	End User	Public
Get:	-	-	-
Description		Syntax	
Set:	Recall saved preset list	# PRST-RCL [SP] <i>preset</i> [CR]	
Get:	-	-	
Response			
~nn@ PRST-RCL [SP] <i>preset</i> [CR LF]			
Parameters			
<i>preset</i> – preset number: 1(OUT 1)... 4(OUT 4); 5(IN 1)...8(IN 4)			
K-Config Example			
Recall preset 1: `#PRST-RCL 1",0x0D			

PRST-LST?

Command Name		Permission	Transparency
Set:	-	-	-
Get:	PRST-LST?	End User	Public
Description		Syntax	
Set:	-	-	
Get:	Get saved preset list	# PRST-LST? [CR]	
Response			
~nn@ PRST-LST [SP] <i>preset,preset,...</i> [CR LF]			
Parameters			
<i>preset</i> – 1 to 8 (preset number)			
Notes			
In most units, video and audio presets with the same number are stored and recalled together by commands #PRST-STO and #PRST-RCL			
K-Config Example			
Get saved preset list: `#PRST-LST?",0x0D			

BAUD

Functions		Permission	Transparency
Set:	BAUD	Administrator	Public
Get:	BAUD?	Administrator	Public
Description		Syntax	
Set:	Set protocol serial port baud rate	#BAUD SP baud_rate CR	
Get:	Get protocol serial port baud rate (for current baud rate)	#BAUD? CR	
Response			
~nn@BAUD SP baud_rate CR LF			
~nn@BAUD SP current_baud_rate CR LF			
Parameters			
<i>baud_rate</i> – 9600, 115200, else (new baud rate to set)			
<i>current_baud_rate</i> – 9600, 115200, else (current protocol serial port baud rate)			
Notes			
The new defined baud rate is stored in the EEPROM and used when powering up Default baud rate is 115200 (on factory reset). Only works with devices supporting this command (if ERR 002 is returned, the default baud rate is used).			
K-Config Example			
Set the baud rate to 9600: "#BAUD 9600",0x0D			

HDCP-STAT

Functions		Permission	Transparency
Set:	-	-	-
Get	HDCP-STAT?	End User	Public
Description		Syntax	
Set:	-	-	
Get:	Get HDCP signal status	# HDCP-STAT? <code>[SP]</code> <i>stage, stage_id</i> <code>[CR]</code>	
Response			
~ <code>[nn]</code> @ HDCP-STAT <code>[SP]</code> <i>stage, stage_id, status</i> <code>[CR LF]</code>			
Parameters			
<i>stage</i> – 0 (input), 1 (output) <i>stage_id</i> – for input stage: 1 (IN 1), 2 (IN 2), 3 (IN 3), 4 (IN 4), 0 (Output disconnected); for output stage 1 (OUT 1), 2 (OUT 2), 3 (OUT 3), 4 (OUT 4) <i>status</i> – signal encryption On/Off status: 0 (HDCP Off), 1 (HDCP On), 2 (Follow input), 3 (Mirror output (Mac mode))			
Response Triggers			
Response is sent to the com port from which the Set (before execution) / Get command was received Response is sent to all com ports after execution if HDCP-STAT was set by any other external control device (button press, device menu and similar) or HDCP mode changed.			
Notes			
On output – sink status. On input – signal status.			
K-Config Example			
Get the output HDCP-STATUS of IN 1: "#HDCP-STAT? 0,1",0x0D			

HDCP-MOD

Functions		Permission	Transparency
Set:	HDCP-MOD	Administrator	Public
Get	HDCP-MOD?	End User	Public
Description		Syntax	
Set:	Set HDCP mode	# HDCP-MOD [SP] <i>inp_id,mode</i> [CR]	
Get:	Get HDCP mode	# HDCP-MOD? [SP] <i>inp_id</i> [CR]	
Response			
Set/get: ~[nn]@ HDCP-MOD [SP] <i>inp_id,mode</i> [CR LF]			
Parameters			
<i>inp_id</i> – input number: 1 (IN 1), 2 (IN 2), 3 (IN 3), 4 (IN 4)			
<i>mode</i> – HDCP mode: 0 (HDCP Off), 1 (HDCP On)			
Response Triggers			
Response is sent to the com port from which the Set (before execution) / Get command was received			
Response is sent to all com ports after execution if HDCP-MOD was set by any other external control device (button press, device menu and similar) or HDCP mode changed.			
Notes			
Set HDCP working mode on the device input: HDCP supported – HDCP_ON (default) HDCP not supported – HDCP OFF HDCP supports changes following a detected sink - MIRROR OUTPUT			
K-Config Example			
Set the input HDCP-MODE of IN 1 to Off: "#HDCP-MOD 1,0",0x0D			

FPGA-VER

Functions		Permission	Transparency
Set:	-	-	-
Get	FPGA-VER?	End User	Public
Description		Syntax	
Set:	-	-	
Get:	Get current FPGA version	# FPGA-VER? [SP] <i>id</i> [CR]	
Response			
~[nn]@ FPGA-VER [SP] <i>id,expected_ver,actual_ver</i> [CR LF]			
Parameters			
<i>id</i> – FPGA ID			
<i>expected_ver</i> – expected FPGA version for current firmware			
<i>actual_ver</i> – actual FPGA version			
K-Config Example			
Get current FPGA version: "#FPGA-VER? 1",0x0D			

LABEL

Command Name		Permission	Transparency
Set:	LABEL	End User	Public
Get:	LABEL?	End User	Public
Description		Syntax	
Set:	Set input/output label	# LABEL [SP] <i>stage, stage_id, switch, label</i> [CR]	
Get:	Get input/output label	# LABEL? [SP] <i>stage_id</i> [CR]	
Response			
~ [nn] @LABEL [SP] <i>stage, stage_id, switch, label</i> [CR LF]			
Parameters			
<i>stage</i> – 0 (Input), 1 (Output) <i>stage_id</i> – 1 (Input/Output 1), 2 (Input/Output 2), 3 (Input/Output 3), 4 (Input/Output 4) <i>switch</i> – on (Enable custom label), off (Disable custom label) <i>label</i> – custom label string			
K-Config Example			
Set input 1 label to “player” and enable: “#LABEL 1,1,on,player”,0x0D			

Authentication Commands

Command	Description
LOGIN	Set/get protocol permission
LOGOUT	Cancel current permission level
PASS	Set/get password for login level
SECUR	Set/get current security state

LOGIN

Functions		Permission	Transparency
Set:	LOGIN	Not Secure	Public
Get:	LOGIN?	Not Secure	Public
Description		Syntax	
Set:	Set protocol permission	#LOGIN <code>[SP]</code> <i>login_level</i> , <i>password</i> <code>[CR]</code>	
Get:	Get current protocol permission level	#LOGIN? <code>[CR]</code>	
Response			
Set: ~ <code>[nn]</code> @LOGIN <code>[SP]</code> <i>login_level</i> , <i>password</i> <code>[SP]</code> OK <code>[CR LF]</code> or ~ <code>[nn]</code> @LOGIN <code>[SP]</code> ERR <code>[SP]</code> 004 <code>[CR LF]</code> (if bad password entered)			
Get: ~ <code>[nn]</code> @LOGIN <code>[SP]</code> <i>login_level</i> <code>[CR LF]</code>			
Parameters			
<i>login_level</i> – level of permissions required: User, Admin <i>password</i> – predefined password (by PASS command). Default password is an empty string			
Notes			
When the permission system is enabled, LOGIN enables running commands with the User or Administrator permission level. When set, login must be performed upon each connection. The permission system works only if security is enabled with the SECUR command. It is not mandatory to enable the permission system in order to use the device.			
K-Config Example			
Set the protocol permission level to Admin (when the password defined in the PASS command is 33333): `#LOGIN Admin,33333",0x0D`			

LOGOUT

Functions		Permission	Transparency
Set:	LOGOUT	Not Secure	Public
Get:	-	-	-
Description		Syntax	
Set:	Cancel current permission level	#LOGOUT <code>[CR]</code>	
Get:	-	-	
Response			
~ <code>[nn]</code> @LOGOUT <code>[SP]</code> OK <code>[CR LF]</code>			
Notes			
Logs out from User or Administrator permission levels.			
K-Config Example			
`#LOGOUT",0x0D`			

PASS

Functions		Permission	Transparency
Set:	PASS	Administrator	Public
Get:	PASS?	Administrator	Public
Description		Syntax	
Set:	Set password for login level	# PASS [SP] <i>login_level</i> , <i>password</i> [CR]	
Get:	Get password for login level	# PASS? [SP] <i>login_level</i> [CR]	
Response			
~ <i>nn</i> @ PASS [SP] <i>login_level</i> , <i>password</i> [CR LF]			
Parameters			
<i>login_level</i> – level of login to set: User, Admin <i>password</i> – password for the <i>login_level</i> . Up to 15 printable ASCII chars.			
Notes			
The default password is an empty string.			
K-Config Example			
Set the password for the Admin protocol permission level to 33333: `#PASS Admin,33333`,0x0D			

SECUR

Functions		Permission	Transparency
Set:	SECUR	Administrator	Public
Get:	SECUR?	Not Secure	Public
Description		Syntax	
Set:	Start/stop security	# SECUR [SP] <i>security_mode</i> [CR]	
Get:	Get current security state	# SECUR? [CR]	
Response			
~ <i>nn</i> @ SECUR [SP] <i>security_mode</i> [CR LF]			
Parameters			
<i>security_mode</i> – 1 (On / enable security), 0 (Off / disable security)			
Notes			
The permission system works only if security is enabled with the SECUR command.			
K-Config Example			
Enable the permission system: `#SECUR 0`,0x0D			

EDID Handling Commands

Additional EDID data functions can be performed via a compatible EDID management application, such as Kramer EDID Designer (see www.kramerav.com/product/EDID%20Designer).

Command	Description
CPEDID	Copy EDID data from the output to the input EEPROM

CPEDID

Functions		Permission	Transparency
Set:	CPEDID	End User	Public
Get:	-	-	-
Description		Syntax	
Set:	Copy EDID data from the output to the input EEPROM	#CPEDID [SP]src_type,src_id,dst_type,dest_bitmap[CR]	
Get:	-	-	
Response			
~nn@CPEDID[SP]src_type,src_id,dst_type,dest_bitmap[CR LF]			
Parameters			
<p>src_type – EDID source type (usually output): 0 (Input), 1 (Output), 2 (Default EDID)</p> <p>src_id – for input source: 1 (Input), for output source: 0 (Default EDID source), 1 (Output 1), 2 (Output 2)</p> <p>dst_type – EDID destination type (usually input): 0 (Input)</p> <p>dest_bitmap – bitmap representing destination IDs. Format: xxxx...x, where x is hex digit. The binary form of every hex digit represents corresponding destinations. Setting '1' indicates that EDID data is copied to this destination. Setting '0' indicates that EDID data is not copied to this destination.</p>			
Response Triggers			
Response is sent to the com port from which the Set was received (before execution)			
Notes			
<p>Destination bitmap size depends on device properties (for 64 inputs it is a 64-bit word)</p> <p>Example: bitmap 0x0013 means inputs 1, 2 and 5 are loaded with the new EDID.</p> <p>In this device, if the destination type is input (0), the bitmap size is 8 bit, for example bitmap 0x81 means the inputs 1 and 8 are loaded with the new EDID.</p>			
K-Config Example			
Copy the EDID data from the Output 1 (EDID source) to the Input:			
`#CPEDID 1,1,0,0x1",0x0D`			
Copy the EDID data from the default EDID source to the Input:			
`#CPEDID 2,0,0,0x1",0x0D`			

Switch Commands

Command	Description
AV	Switch audio and video
VID	Set video switch state
VID-PATTERN	Select output pattern
AUD	Switch audio only
INFO-IO?	Get number of inputs/outputs in the unit
INFO-PRST	Get maximum number of video/audio presets in the unit
PRST-AUD?	Get audio connections from saved preset

AV

Functions		Permission	Transparency
Set:	AV	End User	Public
Get:	-	-	-
Description		Syntax	
Set:	Switch audio and video	#AV[SP]in>out, in>out,...[CR]	
Get:	-	-	
Response			
~nn[AV][SP]in>out, in>out,...[CR LF]			
Parameters			
<i>in</i> – input number: 1 (IN 1), 2 (IN 2), 3 (IN 3), 4 (IN 4), 0 (output disconnected) > – connection character between in and out parameters <i>out</i> – output number: 1 (OUT 1), 2 (OUT 2), 3 (OUT 3), 4 (OUT 4), * (all outputs)			
K-Config Example			
Switch IN 1 to OUT 4: "#AV 1>4", 0x0D			

VID

Functions		Permission	Transparency
Set:	VID	End User	Public
Get:	VID?	End User	Public
Description		Syntax	
Set:	Set video switch state	#VID[SP]in>out[CR]	
Get:	Get video switch state	#VID?[SP]out[CR]	
Response			
Set:~nn[VID][SP]in>out[CR LF] Get:~nn[VID][SP]in>out[CR LF]			
Parameters			
<i>in</i> – input number: 1 (IN 1), 2 (IN 2), 3 (IN 3), 4 (IN 4), 5 (pattern selection), 0 (output disconnected) > – connection character between IN and OUT parameters <i>out</i> – output number: 1 (OUT 1), 2 (OUT 2), 3 (OUT 3), 4 (OUT 4), * (all outputs)			
K-Config Example			
Switch IN 1 to OUT 3: "#VID 1>3", 0x0D			

VID-PATTERN

Functions		Permission	Transparency
Set:	VID-PATTERN	End User	Public
Get:	VID-PATTERN?	End User	Public
Description		Syntax	
Set:	Select output pattern	#VID-PATTERN SP out, pattern_id CR	
Get:	Get current pattern selected	#VID-PATTERN? SP out CR	
Response			
Set:	~nn@VID-PATTERN SP out, pattern_id CR LF		
Get:	~nn@VID-PATTERN SP out, pattern_id CR LF		
Parameters			
<i>out</i> – output number: 1 (OUT 1), 2 (OUT 2), 3 (OUT 3), 4 (OUT 4) > – connection character between IN and OUT parameters <i>pattern_id</i> – select pattern: 1 (Pattern 1), 2 (Pattern 2), 3 (Pattern 3), 4 (Pattern 4), 5 (Pattern 5), 6 (Pattern 6), 7 (Pattern 7), 8 (Pattern 8)			
K-Config Example			
Switch PATTERN 1 to OUT 3: "#VID-PATTERN 3,1",0x0D			

AUD

Functions		Permission	Transparency
Set:	AUD	End User	Public
Get:	AUD?	End User	Public
Description		Syntax	
Set:	Set audio switch state	#AUD SP in>out, in>out, ... CR	
Get:	Get audio switch state	#AUD? SP out CR #AUD? SP * CR	
Response			
Set:	~nn@AUD SP in>out CR LF ~nn@AUD SP in>out CR LF		
Get:	~nn@AUD SP in>out CR LF ~nn@AUD SP in>1, in>2, ... CR LF		
Parameters			
<i>In</i> – input number: 1 (HDMI IN 1), 2 (HDMI IN 2), 3 (HDMI IN 3), 4 (HDMI IN 4), 0 (output disconnected) > – connection character between in and out parameters <i>out</i> – output number: 1 (HDMI OUT 1), 2 (HDMI OUT 2), 3 (HDMI OUT 3), 4 (HDMI OUT 4), * (all outputs)			
Notes			
When AFV switching mode is active, this command also switches video and unit replies with command ~AV.			
K-Config Examples			
Switch embedded audio HDMI IN 1 to HDMI OUT 3: "#AUD 1>3",0x0D			

INFO-IO

Functions		Permission	Transparency
Set:	-	-	-
Get:	INFO-IO?	End User	Public
Description		Syntax	
Set:	-	-	
Get:	Get in/out count	# INFO-IO? <code>[CR]</code>	
Response			
~ <code>[nn]</code> @ INFO-IO <code>[SP]</code> <i>IN</i> <code>[SP]</code> <i>inputs_count</i> , <code>[OUT]</code> <code>[SP]</code> <i>outputs_count</i> <code>[CR LF]</code>			
Parameters			
<i>inputs_count</i> – 4 (number of inputs in the unit) <i>outputs_count</i> – 4 (number of outputs in the unit)			
K-Config Example			
Get inputs count: `#INFO-IO?`, 0x0D			

INFO-PRST

Functions		Permission	Transparency
Set:	-	-	-
Get:	INFO-PRST?	End User	Public
Description		Syntax	
Set:	-	-	
Get:	Get maximum preset count	# INFO-PRST? <code>[CR]</code>	
Response			
~ <code>[nn]</code> @ INFO-PRST <code>[SP]</code> <i>VID</i> <code>[SP]</code> <i>preset_video_count</i> , <code>[AUD]</code> <code>[SP]</code> <i>preset_audio_count</i> <code>[CR LF]</code>			
Parameters			
<i>preset_video_count</i> – maximum number of video presets in the unit <i>preset_audio_count</i> – maximum number of audio presets in the unit			
Notes			
In most units, video and audio presets with the same number are stored and recalled together by commands #PRST-STO and #PRST-RCL.			
K-Config Example			
Get number of video and audio presets: `#INFO-PRST?`, 0x0D			

PRST-AUD

Functions		Permission	Transparency
Set:	-	-	-
Get:	PRST-AUD?	End User	Public
Description		Syntax	
Set:	-	-	
Get:	Get audio connections from saved preset	# PRST-AUD? [SP]preset,out[CR] # PRST-AUD? [SP]preset,*[CR]	
Response			
~[nn]@ PRST-AUD [SP]preset, in>out[CR LF] ~[nn]@ PRST-AUD [SP]preset, in>1, in>2, in>3,...[CR LF]			
Parameters			
<p>preset – preset number</p> <p>n – input number: 1 (IN 1), 2 (IN 2), 3 (IN 3), 4 (IN 4), 0 (Output disconnected)</p> <p>> – Connection character between in and out parameters</p> <p>out – Output number: 1 (OUT 1), 2 (OUT 2), 3 (OUT 3), 4 (OUT 4), * (All outputs)</p>			
Notes			
In most units, video and audio presets with the same number are stored and recalled together by commands # PRST-STO and # PRST-RCL .			
K-Config Example			
Get audio connection IN 1 to OUT 3 from saved preset 1: `# PRST-AUD? 1",0x0D			

Switching Commands

Command	Description
MTX-MODE	Set/get to auto-switch mode
VMUTE	Set/get video on output status

MTX-MODE

Functions		Permission	Transparency
Set:	MTX-MODE	End User	Public
Get:	MTX-MODE?	End User	Public
Description		Syntax	
Set:	Set auto-switch mode	# MTX-MODE [SP]output_id,mode[CR]	
Get :	Get auto-switch mode	# MTX-MODE? [SP]output_id[CR]	
Response			
~[nn]@ MTX-MODE [SP]output_id,mode[CR]			
Parameters			
<p>output_id – 1 (OUT 1), 2 (OUT 2), 3 (OUT 3), 4 (OUT 4)</p> <p>mode – 0 (manual), 1 (auto priority) 2 (auto last connected)</p>			
Response Triggers			
<p>After execution, a response is sent to the com port from which the Set/Get was received</p> <p>After execution, a response is sent to all com ports if MTX-MODE was set by any other external control device (button press, WEB, device menu and similar)</p>			
Notes			
Not recommended for new devices.			
K-Config Example			
Set output to last connected: `# MTX-MODE 1,2",0x0D			

VMUTE

Functions		Permission	Transparency
Set:	VMUTE	End User	Public
Get:	VMUTE?	End User	Public
Description		Syntax	
Set:	Set enable/disable video on output	# VMUTE [SP] <i>output_id,flag</i> [CR]	
Get:	Get video on output status	# VMUTE? [SP] <i>output_id</i> [SP] [CR]	
Response			
Set / Get: ~nn@ VMUTE [SP] <i>output_id,flag</i> [CR LF]			
Parameters			
<i>output_id</i> – 1 (OUT 1), 2 (OUT 2), 3 (OUT 3), 4 (OUT 4)			
<i>flag</i> – 0 (disable video on output), 1 (enable video on output), 2 (blank video)			
K-Config Example			
Disable the video output on OUT 2: "#VMUTE 2,0",0x0D			

Communication Commands

Command	Description
ETH-PORT	Set/get Ethernet port protocol
NET-DHCP	Set/get DHCP mode
NET-GATE	Set/get gateway IP
NET-IP	Set/get IP address
NET-MAC	Get MAC address
NET-MASK	Set/get subnet mask
UART	Set/get port tunneling UART configuration

ETH-PORT

Functions		Permission	Transparency
Set:	ETH-PORT	Administrator	Public
Get:	ETH-PORT?	End User	Public
Description		Syntax	
Set:	Set Ethernet port protocol	# ETH-PORT [SP] <i>portType,ETHPort</i> [CR]	
Get:	Get Ethernet port protocol	# ETH-PORT? [SP] <i>portType</i> [CR]	
Response			
~nn@ ETH-PORT [SP] <i>portType,ETHPort</i> [CR LF]			
Parameters			
<i>portType</i> – string of 3 letters indicating the port type: TCP, UDP			
<i>ETHPort</i> – TCP / UDP port number: 0-65565			
Notes			
If the port number you enter is already in use, an error is returned. The port number must be within the following range: 0-(2 ¹⁶ -1).			
K-Config Example			
Set the Ethernet port protocol for TCP to port 12457: "#ETH-PORT TCP,12457",0x0D			

NET-DHCP

Functions		Permission	Transparency
Set:	NET-DHCP	Administrator	Public
Get:	NET-DHCP?	End User	Public
Description		Syntax	
Set:	Set DHCP mode	#NET-DHCP <input type="text" value="mode"/> <input type="text" value="CR"/>	
Get:	Get DHCP mode	#NET-DHCP? <input type="text" value="CR"/>	
Response			
~nn@NET-DHCP <input type="text" value="mode"/> <input type="text" value="CR"/> LF			
Parameters			
<i>mode</i> – 0 (Do not use DHCP. Use the IP address set by the factory or the NET-IP command), 1 (Try to use DHCP. If unavailable, use the IP address set by the factory or the NET-IP command)			
Notes			
Connecting Ethernet to devices with DHCP may take more time in some networks. To connect with a randomly assigned IP by DHCP, specify the device DNS name (if available) using the NAME command. You can also get an assigned IP by direct connection to RS-232 protocol port, if available. Consult your network administrator for correct settings.			
K-Config Example			
Enable DHCP mode, if available: "#NET-DHCP 1",0x0D			

NET-GATE

Functions		Permission	Transparency
Set:	NET-GATE	Administrator	Public
Get:	NET-GATE?	End User	Public
Description		Syntax	
Set:	Set gateway IP	#NET-GATE <input type="text" value="ip_address"/> <input type="text" value="CR"/>	
Get:	Get gateway IP	#NET-GATE? <input type="text" value="CR"/>	
Response			
~nn@NET-GATE <input type="text" value="ip_address"/> <input type="text" value="CR"/> LF			
Parameters			
<i>ip_address</i> – gateway IP address, in the following format: xxx.xxx.xxx.xxx			
Notes			
A network gateway connects the device via another network, possibly over the Internet. Be careful of security problems. Consult your network administrator for correct settings.			
K-Config Example			
Set the gateway IP address to 192.168.0.1: "#NET-GATE 192.168.000.001",0x0D			

NET-IP

Functions		Permission	Transparency
Set:	NET-IP	Administrator	Public
Get:	NET-IP?	End User	Public
Description		Syntax	
Set:	Set IP address	#NET-IP[SP]ip_address[CR]	
Get:	Get IP address	#NET-IP?[CR]	
Response			
~nn[CR]@NET-IP[SP]ip_address[CR LF]			
Parameters			
ip_address – IP address, in the following format: xxx.xxx.xxx.xxx			
Notes			
Consult your network administrator for correct settings.			
K-Config Example			
Set the IP address to 192.168.1.39: "#NET-IP 192.168.001.039", 0x0D			

NET-MAC

Functions		Permission	Transparency
Set:	-	-	-
Get:	NET-MAC?	End User	Public
Description		Syntax	
Set:	-	-	
Get:	Get MAC address	#NET-MAC?[CR]	
Response			
~nn[CR]@NET-MAC[SP]mac_address[CR LF]			
Parameters			
mac_address – unique MAC address. Format: XX-XX-XX-XX-XX-XX where x is hex digit			
K-Config Example			
"#NET-MAC?", 0x0D			

NET-MASK

Functions		Permission	Transparency
Set:	NET-MASK	Administrator	Public
Get:	NET-MASK?	End User	Public
Description		Syntax	
Set:	Set subnet mask	#NET-MASK[SP]net_mask[CR]	
Get:	Get subnet mask	#NET-MASK?[CR]	
Response			
~nn[CR]@NET-MASK[SP]net_mask[CR LF]			
Parameters			
net_mask – format: xxx.xxx.xxx.xxx			
Response Triggers			
The subnet mask limits the Ethernet connection within the local network Consult your network administrator for correct settings			
K-Config Example			
Set the subnet mask to 255.255.0.0: "#NET-MASK 255.255.000.000", 0x0D			

UART

Functions		Permission	Transparency
Set:	UART	Administrator	Public
Get:	UART?	End User	Public
Description		Syntax	
Set:	Set port tunneling UART configuration	#UART <input type="text"/> <input type="text"/> <i>com_num,baud_rate,data_bits,parity,stop_bits</i> <input type="text"/>	
Get:	Get port tunneling UART configuration	#UART? <input type="text"/> <input type="text"/>	
Response			
~ <input type="text"/> @UART <input type="text"/> <i>baud_rate,data_bits,parity,stop_bits</i> <input type="text"/> OK <input type="text"/> LF			
Parameters			
<i>com_num</i> – 1 <i>baude_rate</i> – 1200, 2400, 4800, 9600, 19200, 38400, 57600, 115200 <i>data_bits</i> – 5 to 8 <i>parity</i> – none, odd, even, mark, space, n, o, e, m, s <i>stop_bits</i> – 1, 2			
K-Config Example			
Set baud rate to 9600, 8 data bits, parity to none and stop bit to 1: "#UART 1,9600,8,node,1",0x0D			

The warranty obligations of Kramer Electronics Inc. ("Kramer Electronics") for this product are limited to the terms set forth below:

What is Covered

This limited warranty covers defects in materials and workmanship in this product.

What is Not Covered

This limited warranty does not cover any damage, deterioration or malfunction resulting from any alteration, modification, improper or unreasonable use or maintenance, misuse, abuse, accident, neglect, exposure to excess moisture, fire, improper packing and shipping (such claims must be presented to the carrier), lightning, power surges, or other acts of nature. This limited warranty does not cover any damage, deterioration or malfunction resulting from the installation or removal of this product from any installation, any unauthorized tampering with this product, any repairs attempted by anyone unauthorized by Kramer Electronics to make such repairs, or any other cause which does not relate directly to a defect in materials and/or workmanship of this product. This limited warranty does not cover cartons, equipment enclosures, cables or accessories used in conjunction with this product.

Without limiting any other exclusion herein, Kramer Electronics does not warrant that the product covered hereby, including, without limitation, the technology and/or integrated circuit(s) included in the product, will not become obsolete or that such items are or will remain compatible with any other product or technology with which the product may be used.

How Long this Coverage Lasts

The standard limited warranty for Kramer products is seven (7) years from the date of original purchase, with the following exceptions:

1. All Kramer VIA hardware products are covered by a standard three (3) year warranty for the VIA hardware and a standard three (3) year warranty for firmware and software updates.
2. All Kramer fiber optic cables, adapter-size fiber optic extenders, active cables, cable retractors, all Kramer speakers and Kramer touch panels are covered by a standard one (1) year warranty.
3. All Kramer Cobra products, all Kramer Calibre products, all Kramer Minicom digital signage products, all HighSecLabs products, all streaming, and all wireless products are covered by a standard three (3) year warranty.
4. All Sierra Video MultiViewers are covered by a standard five (5) year warranty.
5. Sierra switchers & control panels are covered by a standard seven (7) year warranty (excluding power supplies and fans that are covered for three (3) years).
6. K-Touch software is covered by a standard one (1) year warranty for software updates.
7. All Kramer passive cables are covered by a ten (10) year warranty.

Who is Covered

Only the original purchaser of this product is covered under this limited warranty. This limited warranty is not transferable to subsequent purchasers or owners of this product.

What Kramer Electronics Will Do

Kramer Electronics will, at its sole option, provide one of the following three remedies to whatever extent it shall deem necessary to satisfy a proper claim under this limited warranty:

1. Elect to repair or facilitate the repair of any defective parts within a reasonable period of time, free of any charge for the necessary parts and labor to complete the repair and restore this product to its proper operating condition. Kramer Electronics will also pay the shipping costs necessary to return this product once the repair is complete.
2. Replace this product with a direct replacement or with a similar product deemed by Kramer Electronics to perform substantially the same function as the original product.
3. Issue a refund of the original purchase price less depreciation to be determined based on the age of the product at the time remedy is sought under this limited warranty.

What Kramer Electronics Will Not Do Under This Limited Warranty

If this product is returned to Kramer Electronics or the authorized dealer from which it was purchased or any other party authorized to repair Kramer Electronics products, this product must be insured during shipment, with the insurance and shipping charges prepaid by you. If this product is returned uninsured, you assume all risks of loss or damage during shipment. Kramer Electronics will not be responsible for any costs related to the removal or re-installation of this product from or into any installation. Kramer Electronics will not be responsible for any costs related to any setting up this product, any adjustment of user controls or any programming required for a specific installation of this product.

How to Obtain a Remedy Under This Limited Warranty

To obtain a remedy under this limited warranty, you must contact either the authorized Kramer Electronics reseller from whom you purchased this product or the Kramer Electronics office nearest you. For a list of authorized Kramer Electronics resellers and/or Kramer Electronics authorized service providers, visit our web site at www.kramerav.com or contact the Kramer Electronics office nearest you.

In order to pursue any remedy under this limited warranty, you must possess an original, dated receipt as proof of purchase from an authorized Kramer Electronics reseller. If this product is returned under this limited warranty, a return authorization number, obtained from Kramer Electronics, will be required (RMA number). You may also be directed to an authorized reseller or a person authorized by Kramer Electronics to repair the product.

If it is decided that this product should be returned directly to Kramer Electronics, this product should be properly packed, preferably in the original carton, for shipping. Cartons not bearing a return authorization number will be refused.

Limitation of Liability

THE MAXIMUM LIABILITY OF KRAMER ELECTRONICS UNDER THIS LIMITED WARRANTY SHALL NOT EXCEED THE ACTUAL PURCHASE PRICE PAID FOR THE PRODUCT. TO THE MAXIMUM EXTENT PERMITTED BY LAW, KRAMER ELECTRONICS IS NOT RESPONSIBLE FOR DIRECT, SPECIAL, INCIDENTAL OR CONSEQUENTIAL DAMAGES RESULTING FROM ANY BREACH OF WARRANTY OR CONDITION, OR UNDER ANY OTHER LEGAL THEORY. Some countries, districts or states do not allow the exclusion or limitation of relief, special, incidental, consequential or indirect damages, or the limitation of liability to specified amounts, so the above limitations or exclusions may not apply to you.

Exclusive Remedy

TO THE MAXIMUM EXTENT PERMITTED BY LAW, THIS LIMITED WARRANTY AND THE REMEDIES SET FORTH ABOVE ARE EXCLUSIVE AND IN LIEU OF ALL OTHER WARRANTIES, REMEDIES AND CONDITIONS, WHETHER ORAL OR WRITTEN, EXPRESS OR IMPLIED. TO THE MAXIMUM EXTENT PERMITTED BY LAW, KRAMER ELECTRONICS SPECIFICALLY DISCLAIMS ANY AND ALL IMPLIED WARRANTIES, INCLUDING, WITHOUT LIMITATION, WARRANTIES OF MERCHANTABILITY AND FITNESS FOR A PARTICULAR PURPOSE. IF KRAMER ELECTRONICS CANNOT LAWFULLY DISCLAIM OR EXCLUDE IMPLIED WARRANTIES UNDER APPLICABLE LAW, THEN ALL IMPLIED WARRANTIES COVERING THIS PRODUCT, INCLUDING WARRANTIES OF MERCHANTABILITY AND FITNESS FOR A PARTICULAR PURPOSE, SHALL APPLY TO THIS PRODUCT AS PROVIDED UNDER APPLICABLE LAW. IF ANY PRODUCT TO WHICH THIS LIMITED WARRANTY APPLIES IS A "CONSUMER PRODUCT" UNDER THE MAGNUSON-MOSS WARRANTY ACT (15 U.S.C.A. §2301, ET SEQ.) OR OTHER APPLICABLE LAW, THE FOREGOING DISCLAIMER OF IMPLIED WARRANTIES SHALL NOT APPLY TO YOU, AND ALL IMPLIED WARRANTIES ON THIS PRODUCT, INCLUDING WARRANTIES OF MERCHANTABILITY AND FITNESS FOR THE PARTICULAR PURPOSE, SHALL APPLY AS PROVIDED UNDER APPLICABLE LAW.

Other Conditions

This limited warranty gives you specific legal rights, and you may have other rights which vary from country to country or state to state.

This limited warranty is void if (i) the label bearing the serial number of this product has been removed or defaced, (ii) the product is not distributed by Kramer Electronics or (iii) this product is not purchased from an authorized Kramer Electronics reseller. If you are unsure whether a reseller is an authorized Kramer Electronics reseller, visit our web site at www.kramerav.com or contact a Kramer Electronics office from the list at the end of this document.

Your rights under this limited warranty are not diminished if you do not complete and return the product registration form or complete and submit the online product registration form. Kramer Electronics thanks you for purchasing a Kramer Electronics product. We hope it will give you years of satisfaction.



P/N:



2900-300889

Rev:



1



SAFETY WARNING

Disconnect the unit from the power supply before opening and servicing

For the latest information on our products and a list of Kramer distributors, visit our Web site where updates to this user manual may be found.

We welcome your questions, comments, and feedback.