



INSTRUCTION MANUAL

N2300 SERIES N2312 ENCODERS/N2322 DECODERS
DIGITAL MEDIA DISTRIBUTION & SWITCHING SOLUTION

NMX-ENC-N2312, NMX-DEC-N2322



IMPORTANT SAFETY INSTRUCTIONS

1. READ these instructions.
2. KEEP these instructions.
3. HEED all warnings.
4. FOLLOW all instructions.
5. DO NOT use this apparatus near water.
6. CLEAN ONLY with dry cloth.
7. DO NOT block any ventilation openings. Install in accordance with the manufacturer's instructions.
8. DO NOT install near any heat sources such as radiators, heat registers, stoves, or other apparatus (including amplifiers) that produce heat.
9. DO NOT defeat the safety purpose of the polarized or grounding type plug. A polarized plug has two blades with one wider than the other. A grounding type plug has two blades and a third grounding prong. The wider blade or the third prong are provided for your safety. If the provided plug does not fit into your outlet, consult an electrician for replacement of the obsolete outlet.
10. PROTECT the power cord from being walked on or pinched, particularly at plugs, convenience receptacles, and the point where they exit from the apparatus.
11. ONLY USE attachments/accessories specified by the manufacturer.
12. UNPLUG this apparatus during lightning storms or when unused for long periods of time.
13. REFER all servicing to qualified service personnel. Servicing is required when the apparatus has been damaged in any way, such as power supply cord or plug is damaged, liquid has been spilled or objects have fallen into the apparatus, the apparatus has been exposed to rain or moisture, does not operate normally, or has been dropped.
14. DO NOT expose this apparatus to dripping or splashing and ensure that no objects filled with liquids, such as vases, are placed on the apparatus.
15. To completely disconnect this apparatus from the AC Mains, disconnect the power supply cord plug from the AC receptacle.
16. Where the mains plug or an appliance coupler is used as the disconnect device, the disconnect device shall remain readily operable.
17. DO NOT overload wall outlets or extension cords beyond their rated capacity as this can cause electric shock or fire.



The exclamation point, within an equilateral triangle, is intended to alert the user to the presence of important operating and maintenance (servicing) instructions in the literature accompanying the product.



The lightning flash with arrowhead symbol, within an equilateral triangle, is intended to alert the user to the presence of uninsulated "dangerous voltage" within the product's enclosure that may be of sufficient magnitude to constitute a risk of electrical shock to persons.



ESD Warning: The icon to the left indicates text regarding potential danger associated with the discharge of static electricity from an outside source (such as human hands) into an integrated circuit, often resulting in damage to the circuit.

- WARNING:** To reduce the risk of fire or electrical shock, do not expose this apparatus to rain or moisture.
- WARNING:** No naked flame sources - such as candles - should be placed on the product.
- WARNING:** Equipment shall be connected to a MAINS socket outlet with a protective earthing connection.
- WARNING:** To reduce the risk of electric shock, grounding of the center pin of this plug must be maintained.

COPYRIGHT NOTICE

AMX© 2016, all rights reserved. No part of this publication may be reproduced, stored in a retrieval system, or transmitted, in any form or by any means, electronic, mechanical, photocopying, recording, or otherwise, without the prior written permission of AMX. Copyright protection claimed extends to AMX hardware and software and includes all forms and matters copyrightable material and information now allowed by statutory or judicial law or herein after granted, including without limitation, material generated from the software programs which are displayed on the screen such as icons, screen display looks, etc. Reproduction or disassembly of embodied computer programs or algorithms is expressly prohibited.

LIABILITY NOTICE

No patent liability is assumed with respect to the use of information contained herein. While every precaution has been taken in the preparation of this publication, AMX assumes no responsibility for error or omissions. No liability is assumed for damages resulting from the use of the information contained herein. Further, this publication and features described herein are subject to change without notice.

AMX WARRANTY AND RETURN POLICY

The AMX Warranty and Return Policy and related documents can be viewed/downloaded at www.amx.com.

ESD WARNING

	<p>To avoid ESD (Electrostatic Discharge) damage to sensitive components, make sure you are properly grounded before touching any internal materials.</p> <p>When working with any equipment manufactured with electronic devices, proper ESD grounding procedures must be followed to make sure people, products, and tools are as free of static charges as possible. Grounding straps, conductive smocks, and conductive work mats are specifically designed for this purpose.</p> <p>Anyone performing field maintenance on AMX equipment should use an appropriate ESD field service kit complete with at least a dissipative work mat with a ground cord and a UL listed adjustable wrist strap with another ground cord.</p>
---	---

	<p>WARNING: Do Not Open! Risk of Electrical Shock. Voltages in this equipment are hazardous to life. No user-serviceable parts inside. Refer all servicing to qualified service personnel.</p> <p>Place the equipment near a main power supply outlet and make sure that you can easily access the power breaker switch.</p>
---	---

WARNING: This product is intended to be operated ONLY from the voltages listed on the back panel or the recommended, or included, power supply of the product. Operation from other voltages other than those indicated may cause irreversible damage to the product and void the products warranty. The use of AC Plug Adapters is cautioned because it can allow the product to be plugged into voltages in which the product was not designed to operate. If the product is equipped with a detachable power cord, use only the type provided with your product or by your local distributor and/or retailer. If you are unsure of the correct operational voltage, please contact your local distributor and/or retailer.

FCC AND CANADA EMC COMPLIANCE INFORMATION:

This device complies with part 15 of the FCC Rules. Operation is subject to the following two conditions:

- (1) This device may not cause harmful interference, and (2) this device must accept any interference received, including interference that may cause undesired operation.

NOTE: This equipment has been tested and found to comply with the limits for a Class A digital device, pursuant to part 15 of the FCC Rules. These limits are designed to provide reasonable protection against harmful interference in a residential installation. This equipment generates, uses and can radiate radio frequency energy and, if not installed and used in accordance with the instructions, may cause harmful interference to radio communications. However, there is no guarantee that interference will not occur in a particular installation. If this equipment does cause harmful interference to radio or television reception, which can be determined by turning the equipment off and on, the user is encouraged to try to correct the interference by one or more of the following measures:

- Reorient or relocate the receiving antenna.
- Increase the separation between the equipment and receiver.
- Connect the equipment into an outlet on a circuit different from that to which the receiver is connected.
- Consult the dealer or an experienced radio/TV technician for help.

Approved under the verification provision of FCC Part 15 as a Class A Digital Device.

Caution: Changes or modifications not expressly approved by the manufacturer could void the user's authority to operate this device.

CAN ICES-3 (B)/NMB-3(B)

EU COMPLIANCE INFORMATION:

Eligible to bear the CE mark; Conforms to European Union Low Voltage Directive 2006/95/EC; European Union EMC Directive 2004/108/EC; European Union Restriction of Hazardous Substances Recast (RoHS2) Directive 2011/65/EU.

You may obtain a free copy of the Declaration of Conformity by visiting <http://www.amx.com/techcenter/certifications.asp>.

WEEE NOTICE:

	<p>This appliance is labeled in accordance with European Directive 2012/19/EU concerning waste of electrical and electronic equipment (WEEE). This label indicates that this product should not be disposed of with household waste. It should be deposited at an appropriate facility to enable recovery and recycling.</p>
---	--

Table of Contents

Chapter 1: Introducing Your New N2300 Series Devices	6
Product Overview	6
Hardware Overview	6
Chapter 2: Installing and Configuring Your AV Equipment	9
Installation Overview	9
Mounting Options	10
Surface and Wall Mounting	10
Rack Mounting	10
Step-by-Step Installation Instructions.....	12
How IP Address Changes Affect Unit Control	17
Changing IP Addresses	18
Option 1: Assigning IP Addresses Individually (using the Settings page)	18
Option 2: Assigning IP Addresses to Multiple Units (using CSV files)	18
Switching and Scaling Options.....	20
Seamless Switching	20
Control Options.....	21
Primary Control Options.....	21
N-Command Controllers.....	21
Third-Party Controllers	21
N-Act On-Board, Built-In Control	21
N-Touch IP Wall Controller	21
NetLinx	21
KVM Configuration.....	22
Basic Setup	22
Chapter 3: Encoder Configuration Options	23
Settings Page	24
Device Settings Section.....	25
Advanced Settings.....	26
Network Setup Section.....	28
Status Section.....	29
Software Section.....	30
Change Web Password	30
HostPlay Page	31
N-Act Page	32
Serial Page	33
IR Page	34
Logs Page.....	34
Security Page	35
EDID Page.....	35
LLDP Page	37
NetLinx Page	37

Chapter 4: Decoder Configuration Options	39
Settings Page	40
Device Settings Section	41
Advanced Settings	42
Network Setup Section	45
Status Section	46
Software Section	47
Change Web Password	47
Wall Page	48
LocalPlay Page	49
N-Act Page	50
Serial Page	51
IR Page	52
Logs Page	52
Security Page	53
EDID Page	53
LLDP Page	54
NetLinx Page	54
Chapter 5: Troubleshooting	56
Series Default Local/Host Play Troubleshooting Screens	57
Appendix A: NetLinx Control	59
Introduction	59
Common Applications	59
NetLinx Configuration Using the Unit's Webpage	59
Batch Configurations Using N-Able	60
Native Commands Port 1	61
IR/Serial Send Commands Port 3	63
Pass Through Commands	63
IR Port 2	64
Serial Port 3	64
Appendix B: Minimum Network Requirements	65

Introducing Your New N2300 Series Devices

Product Overview

The N2300 AV over IP Series belongs to the N-Series product family from AMX and consists of N2312 Encoders and N2322 Decoders. This series provides a flexible, feature-rich, and simple-to-deploy digital media distribution and switching solution that can be used in 4K applications with resolutions up to 4096x2160, with support for HDCP 2.2. This motion-based wavelet codec solution delivers video with nearly imperceptible latency at an incredibly low 200 Mb/s bandwidth allowing 4K distribution over standard gigabit Ethernet networks.

Any source can be sent to one or more displays by routing through layer-2/layer-3 switches using standard Cat5e cable. Standard features include input scaling, bi-directional serial, IR, embedded 7.1 audio, and KVM-over-IP extension. Card versions compatible with the N-Series N9206 card cage are available for high-density applications.

Features include:

- Design flexibility allows you to start as small as 1x1 and grow the system in increments of single sources and devices by simply adding additional Encoders and Decoders.
- Input and output scaling performed in Encoders or Decoders for maximum flexibility.
- Power over Ethernet (PoE) eliminates the need for a local power supply and speeds installation. Units can still be powered locally by 12VDC. This allows easy rack-mountable, high-density installations.
- Infrared (IR) emitter connection allows control of low-cost, IR-only display devices.
- Fast install with Phoenix connectors for power, IR, RS232 serial, and analog audio interfaces.
- Pass-through HDMI interface allows easy installation with local display, such as desktop PC applications.
- USB-A and USB-B connections for KVM applications.
- Native NetLinx support provided. NetLinx Studio will easily recognize the device.

Hardware Overview

Refer to the following figures (front and rear panel drawings of these devices) and the [Front and Rear Panel Descriptions table](#) on page 7 for hardware details.

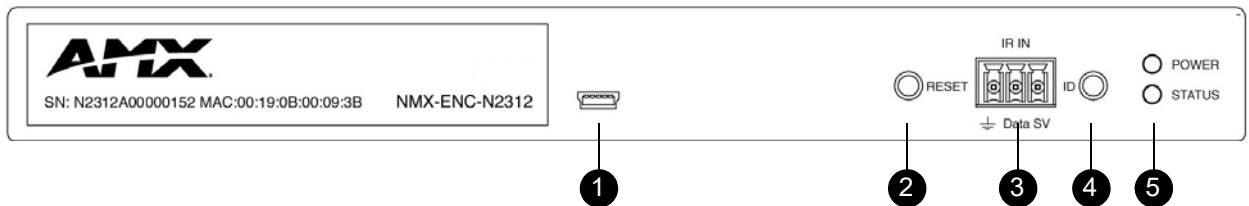

- | | |
|--------------------------------|-------------------------------|
| 1) USB Mini-B Port | 4) Device ID Discovery Button |
| 2) Device Reset Button | 5) Power/Status Indicators |
| 3) IR Emitter Input Connection | |

FIG. 1 N2312 Encoder Front Panel

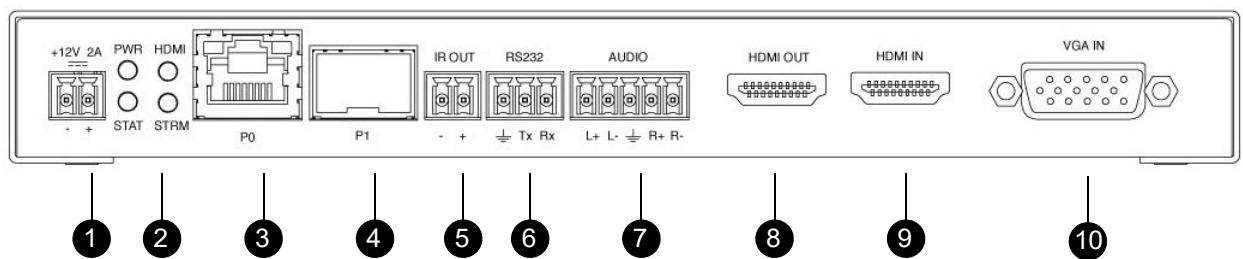

- | | |
|---|----------------------------|
| 1) 12VDC Input (not needed with PoE) | 6) RS232 Connection |
| 2) Status Indicators | 7) Analog Audio Input |
| 3) RJ45 Auto-Sensing Gigabit Ethernet Switch Port — PoE | 8) Passthru HDMI Video Out |
| 4) RJ45 Auto-Sensing Gigabit Ethernet Switch Port | 9) HDMI Video Input |
| 5) IR Emitter Output Connection | 10) DB-15 Analog Input |

FIG. 2 N2312 Encoder Rear Panel

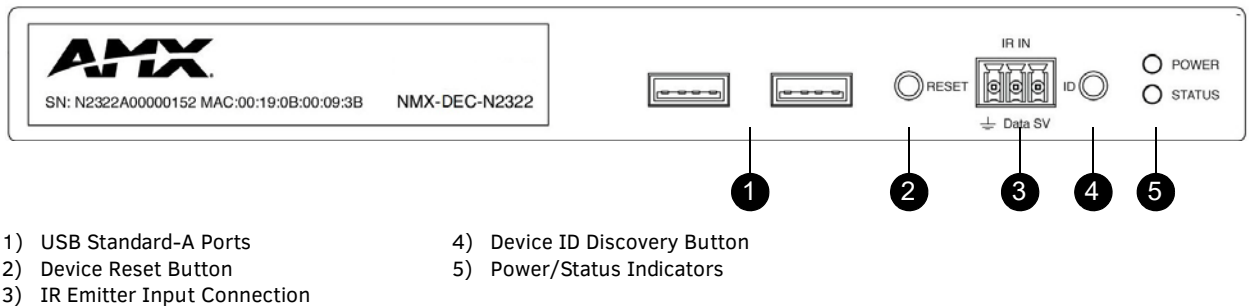

FIG. 3 N2322 Decoder Front Panel

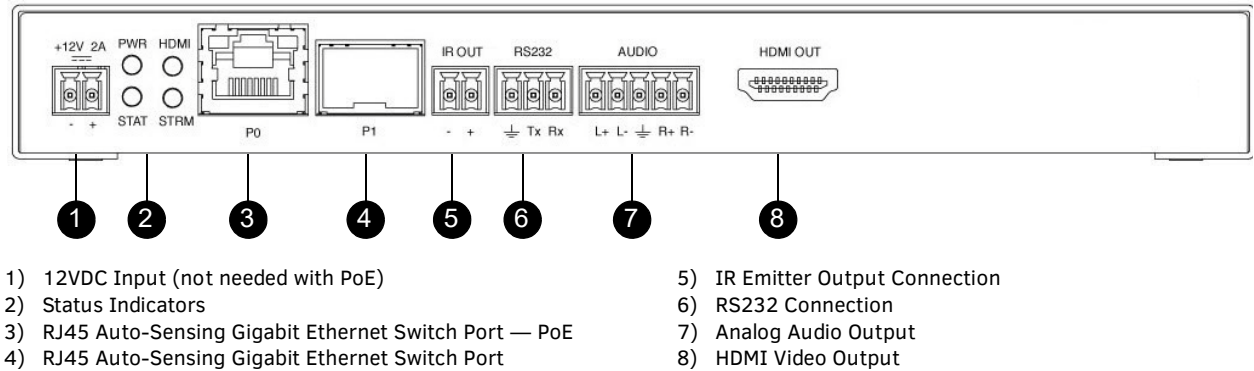

FIG. 4 N2322 Decoder Rear Panel

Front and Rear Panel Descriptions	
Front Panel	
USB Mini-B port	For KVM support. Connects the Encoder to the computer to be controlled.
USB Standard-A port (x2)	For KVM support. Connects the Decoder to keyboard and/or mouse.
RESET button	Recessed pushbutton. Press to initiate a “warm restart” which causes the processor to reset, but not lose power. A reset does NOT affect the current settings.
IR In port	3-pin terminal Phoenix connector. Provides infrared (IR) input only and passes signal back to the connected Encoder/Decoder (33-60 kHz; typically 39 kHz). IR receiver required (not included).
ID button	Recessed pushbutton. Press to send notification out on the network to identify the unit (the notification causes a pop-up dialog in N-Able and N-Command). Press and hold for 30 seconds to initiate a factory restore.
POWER LED	On solid (green) when operating power is supplied (via PoE or local power supply). This activity is also shown by the PWR LED on the rear panel.
STATUS LED	On flashing (green) when there is software activity. This activity is also shown by the STAT LED on the rear panel.
Rear Panel	
+12V 2A	12 Volt DC power input.
PWR LED	Same as POWER LED described above.
HDMI LED	On (green) when an HDMI connection exists.
STAT LED	Same as STATUS LED described above.
STRM LED	On (green) when the unit is streaming video.
P0 POE	8-wire RJ45 female. 10/100/1000 Mbps 10/100/1000Base-T auto-sensing gigabit Ethernet switch port. Provides both the network connection and the power to the Encoders and Decoders.
P1	8-wire RJ45 female. 10/100/1000 Mbps 10/100/1000Base-T auto-sensing gigabit Ethernet switch port. OR 1G SFP port which accepts compatible fiber transceivers or direct attach cables (copper or fiber). Modules sold separately.

Front and Rear Panel Descriptions (Cont.)	
IR OUT	2-pin terminal Phoenix connector. Provides IR output only (33 to 60 kHz; typically 39 kHz). An IR emitter is necessary (not included).
RS232	3-pin terminal Phoenix connector which provides a serial control interface. Full duplex communication. Available terminal speed settings: 1200 to 115200 baud rate.
AUDIO	5-pin terminal Phoenix connector which provides user-selectable balanced/unbalanced, dedicated audio input (for Encoders) and output (for Decoders).
HDMI IN	HDMI video input (Encoders).
HDMI OUT	HDMI video output (Decoders). Passthru HDMI video (Encoders).
VGA IN	DB-15 analog input. Allows for the use of analog video sources. <i>*Applies to Encoders only.</i>

Installing and Configuring Your AV Equipment

This chapter provides an installation overview as well as a detailed step-by-step process for installation. If you encounter any problems, refer to the [Troubleshooting section on page 56](#) for help.

Installation Overview

The N2300 Encoders and Decoders have multiple configuration and installation options. For basic installation guidelines, see the table below. For more detailed instructions, refer to [Step-by-Step Installation Instructions on page 12](#).

Basic Installation Guidelines	
Connections	Options
Power	Power over Ethernet (PoE): Connect the unit's P0 port to an active, PoE-enabled network switch.
	External power supply: If not using PoE for power, connect a 12V regulated power supply (part number N9312) to the unit's two-pin terminal block plug connector labeled +12V 2A.
Network	PoE units: If using PoE to power the unit, you should already have a network connection.
	Externally powered units: If not using PoE, connect either the P0 or P1 port to the network using the appropriate cable.
	Daisy-chain configuration: Once network connection is established to one unit, you can daisy-chain additional units by connecting Ethernet cables between devices using their P0 and/or P1 ports. Keep in mind that the number of units supported in this configuration is limited by bandwidth (total aggregate streams must be less than 1 Gb/s). NOTE: <i>PoE power is only supplied to the unit connected <u>directly to the network</u>. All other units in the daisy-chain must have an external power supply.</i>
Video	N2312 Encoders <ul style="list-style-type: none"> For video encoding of a <i>digital</i> source, connect the source to the Encoder's HDMI IN port using a video cable with an HDMI connector (or adapter). For video encoding of an <i>analog</i> source, connect the source to the Encoder's VGA IN port using a video cable with a VGA connector (or component adapter). For local viewing of pass thru video, connect a digital display to the Encoder's HDMI OUT port using a video cable with an HDMI connector (or adapter).
	N2322 Decoders <ul style="list-style-type: none"> For video decoding, connect a digital display to the Decoder's HDMI OUT port using a video cable with an HDMI connector (or adapter).
Audio	N2312 Encoders <ul style="list-style-type: none"> For audio encoding, connect a line level analog audio source to the Audio input terminal block plug connector, or Use the HDMI audio embedded with the source connection. NOTE: <i>Unit will not pass audio from the analog AUDIO input through the pass thru (HDMI OUT) port.</i>
	N2322 Decoders <ul style="list-style-type: none"> For audio decoding, connect a line level analog audio device to the Audio output terminal block plug connector, or Send the HDMI embedded audio to a connected display's speakers.

NOTE: *When the unit is not in use, remove the power cable and disconnect any other cables (e.g., Ethernet, audio, video) connected to the Encoders and Decoders.*

Acceptable Input/Output Types	
N2312 Encoder - Input	
Digital	HDMI - Native connection. No adapter necessary. DVI - Appropriate passive adapter required. DisplayPort- Appropriate passive adapter required.
Analog	VGA - Native connection. No adapter necessary. Component- Appropriate passive adapter required. RGBHV- Appropriate passive adapter required.
N2322 Decoder - Output	
Digital	HDMI - Native connection. No adapter necessary. DVI- Appropriate passive adapter required. DisplayPort - Appropriate ACTIVE adapter required. The N2322 will not output DisplayPort through a passive adapter.
NOTE: <i>For all other input/output types, an active adapter is required.</i>	

Mounting Options

The N2300 units are available in stand-alone and card versions. The stand-alone version can be free standing, surface mounted, wall mounted, or rack mounted. All cards *must be rack mounted* using the N9206 Card Cage (sold separately).

Surface and Wall Mounting

To mount your N2300 stand-alone unit to a flat surface or wall, follow these steps:

1. Remove the four screws from the bottom of the unit and use them to attach the mounting wings (not included in shipment - part number N9101). See [Figure 5](#).
2. Place the unit against the solid surface to which you want it mounted.
3. Using standard hardware, attach the unit through each of the slots of the newly-attached mounting wings.
4. Connect the appropriate cables necessary for your application. Refer to the sections : [Connecting Decoders to the Network on page 14](#) and : [Connecting Encoders to the Network and Configuring Stream Settings on page 15](#) for more information on these connections.

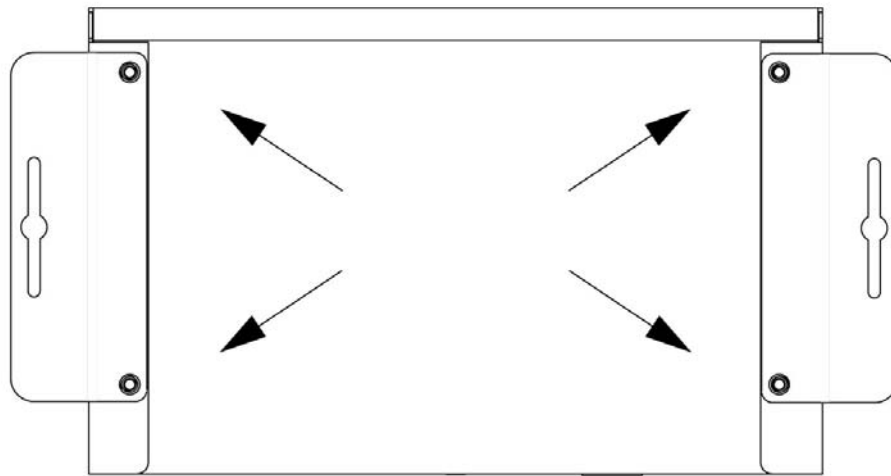

FIG. 5 Installing Mounting Wings

Rack Mounting

N2300 Series Stand-Alone Units

A Rack Shelf (part number N9102) accommodates up to two stand-alone N-Series Encoders or Decoders, side by side (mix and match).

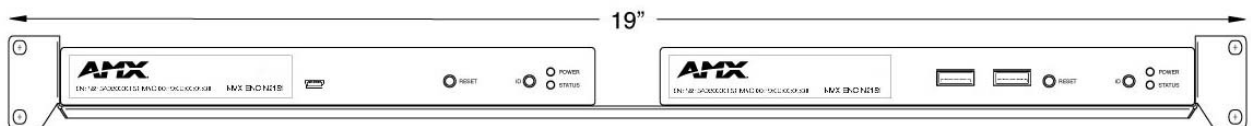

FIG. 6 Rack Mounting Stand-Alone Units

N2300 Series Cards

A Card Cage (part number N9206) accommodates up to six N-Series Encoder/Decoder cards (mix and match). The 12V power supply of the N9206 is the primary power source for the installed cards. If the 12V power supply fails or is unplugged, the cards will power down, detect PoE (if provided by switch) and restart normally using PoE. This usually results in a power loss of about one to two seconds. The unit then reboots (which takes another one to two minutes).

To rack mount N2300 Series cards into the N9206 Card Cage, follow these steps:

1. Gently slide the card into cage slot. Make sure the card is properly aligned with guides. The card's front LED indicators should align with holes in the cage's faceplate. See [Figure 7](#).

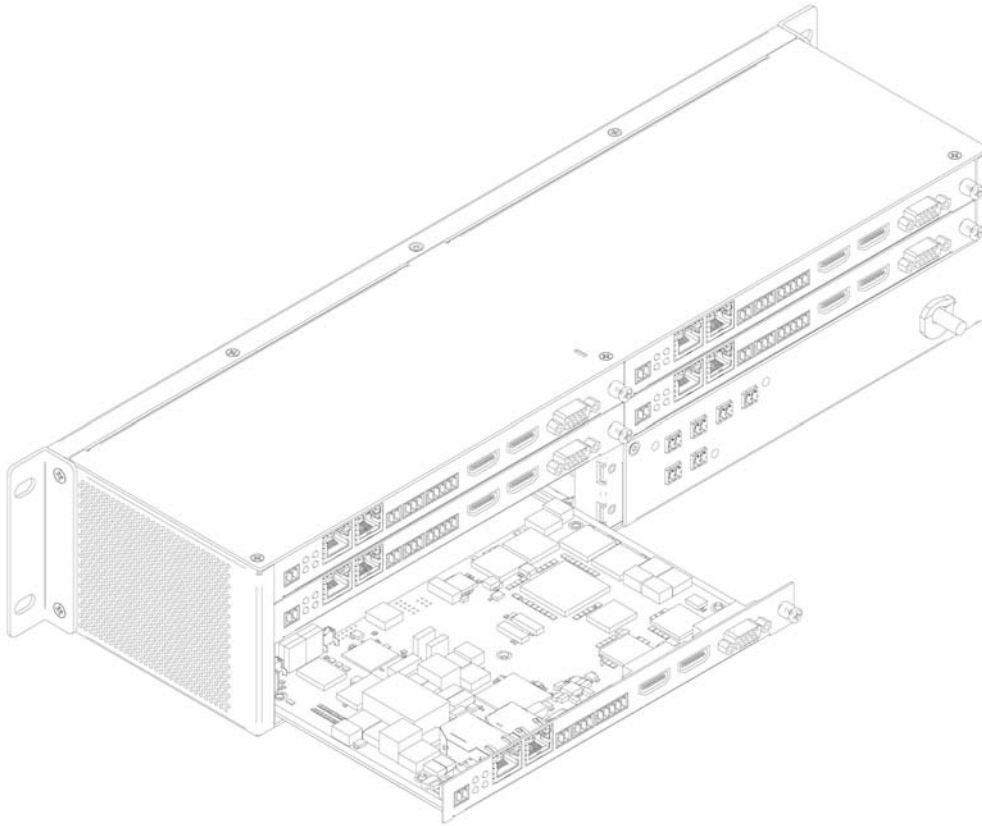

FIG. 7 Rack Mounting Cards

2. Align the thumb screw on back plate before seating card into cage.
3. Firmly seat the card and tighten the thumb screw by hand to secure card placement.
4. Use one of the six Phoenix connector cables (included in shipment with the Card Cage) to connect the card's 12VDC input Phoenix connector to one of the cage's six 12VDC outputs.
5. Repeat these steps until all cards are properly installed. See [Figure 8](#).

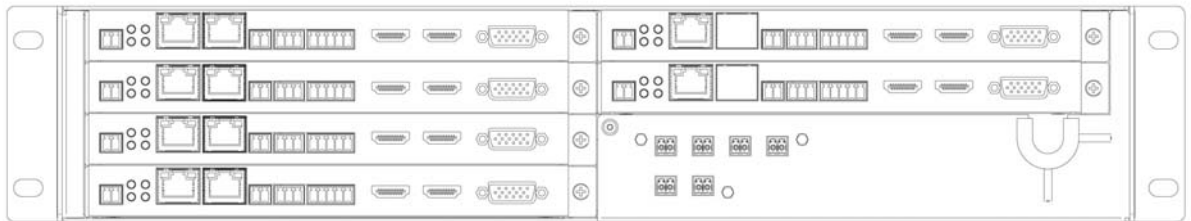

FIG. 8 Fully-Populated Card Cage

6. For proper airflow, cover any unused card slots with faceplate blanks. Blanks are sold separately (part number N9210).
7. Make sure the Card Cage's power cord is plugged in for proper cooling.

CAUTION: Keep the Card Cage's power cord plugged in at all times so that the internal fans are always running. Not doing so could void the warranty of the cage and all installed cards. Fans are not powered while in backup PoE power mode. Please remedy power losses immediately to avoid potential overheating hazards.

NOTE: Mounting accessories are sold separately and are compatible with most N-Series devices. Contact a sales representative or visit our website for details.

Step-by-Step Installation Instructions

This section provides step-by-step guidance for installing and configuring equipment from the N-Series product family on your network. The steps provided here assume the following to be true:

1. *There are switches operational on the network.*
N-Series equipment can operate on many different brands of networking equipment. The network itself needs to meet certain requirements to be able to support deployment. These instructions assume that you have purchased and installed a pre-configured switch from AMX or that your existing equipment meets the following physical and protocol requirements:
 - Layer 2 (with IGMP Multicast Protocol), OR Layer 3 (also known as “multi-layer”)
 - Gigabit Ethernet
 - IGMP Snooping
 - IGMP Snooping Querier (which only needs to be enabled on a single switch within the network)
 - Capable of Jumbo Frames (due to frame density)

NOTE: *To proceed with this installation, the switches must already be successfully connected to your network. If needed, refer to your product's documentation for installation instructions.*
2. *Deployment considerations have been made for the addition of high-speed video.*
Our Networked AV solutions provide unsurpassed video and audio quality at bandwidths appropriate to any network segment or link. Matrix switches as large as 1200x800 have been constructed on a house network using N-Series equipment. Alternatively, many customers choose to deploy on physically separate networks in order to use low-cost network appliances but keep video traffic separate from data and voice.
3. *N-Able software has been loaded on the computer you are using to configure the equipment.*
From your host computer, download N-Able (our free setup utility software):
PC version - <http://www.amx.com/products/N-ABLE-PC.asp>
Mac version - <http://www.amx.com/products/N-ABLE-MAC.asp>

This software is designed to set up and control the equipment during initial deployment, however, it is not always the best solution for production-type or primary user control. Refer to [Control Options on page 21](#) for details on the available control options.

NOTE: *For a more detailed requirements list, refer to [Appendix B: Minimum Network Requirements on page 65](#).*

Step 1: Setting Up Your Host Computer

In order to communicate with N-Series products, your devices must be on the same subnet as the host computer. N2300 units are shipped in **DHCP** mode and the IP address will be assigned automatically based on the network DHCP server. If no DHCP server is found, the unit will use **Auto IP** mode with a default IP address of 169.254.xxx.xxx.

Before beginning installation, you may need to make some changes to the computer running N-Able. These steps show how this can be accomplished in a Microsoft Windows environment.

1. From the **Start** menu, select **Control Panel > Network and Sharing Center**.

2. Select **Change adapter settings**.



3. Double-click the wired interface to your AV network, and then click the **Properties** button.

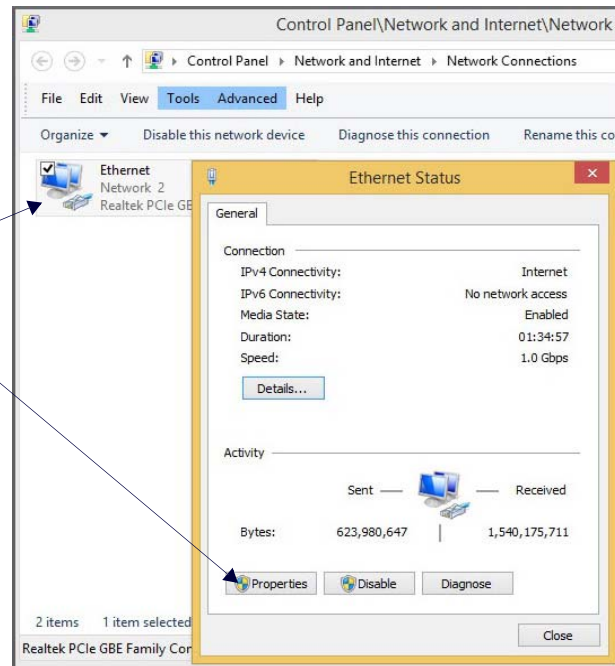

4. Scroll down in the list to the **Internet Protocol Version 4 (TCP/IPv4)** option. Highlight it and click the **Properties** button.

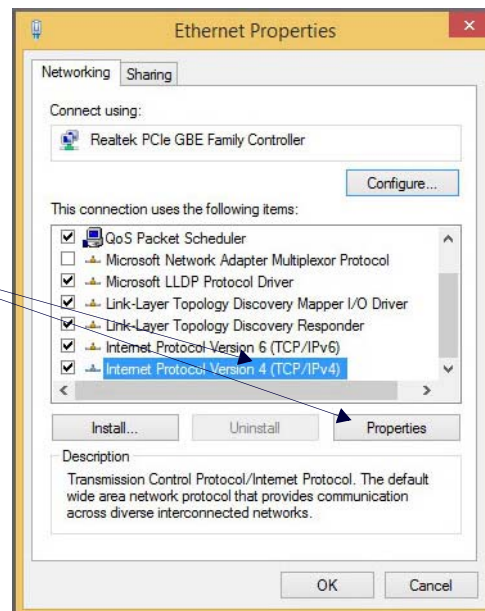

5. Enable the **Use the following IP address** option, and enter the static IP address provided to you by your network administrator.

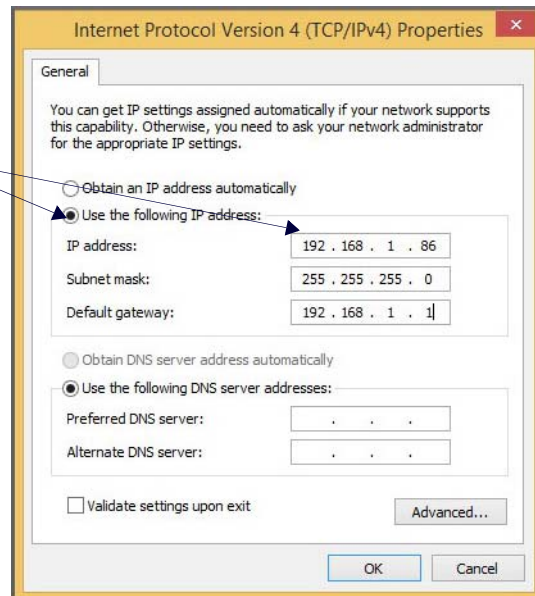

NOTE: If the computer does not need Internet access, you can simply enter a unique 169.254.xxx.xxx IP address with a 255.255.0.0 subnet mask. Contact your network administrator if you are unsure of how to configure the existing network. N-Series units will not self-assign in the 169.254.0.xxx range.

NOTE: If the computer has a statically-assigned IP address, click the **Advanced** button. Then click **Add** to enter a unique 169.254.xxx.xxx address with a Subnet Mask of 255.255.0.0 and a Default Gateway of 169.254.1.1.

Step 2: Connecting Decoders to the Network

The digital connection from a Decoder **HDMI OUT** port (female) to a display is accomplished using either a HDMI cable or DVI-D (through adapter). N2300 units support embedded audio input and output on the HDMI ports; however, some display devices (e.g., many monitors) *do not* support embedded audio. When using such a display, use the **AUDIO** port for separate transmission of sound and turn **HDMI Audio** off (on the **Settings** page) to avoid video display issues.

Power is supplied via a PoE-enabled switch or an external power supply. Refer to the following steps and [Figure 9](#) for guidance.

- Using a Cat-5 cable, connect your N-Series Decoder's **PO** port to a PoE-enabled switch. This provides both network and power connection. In non-PoE applications, connect a 12V regulated power supply (N9312) to the two-pin terminal block plug connector (labeled **+12V 2A**).
- Connect the display you would like to use for that Decoder (monitor, projector, etc.) to the Decoder's **HDMI OUT** port using an HDMI cable (or DVI through adapter). This must be a digital video connection.

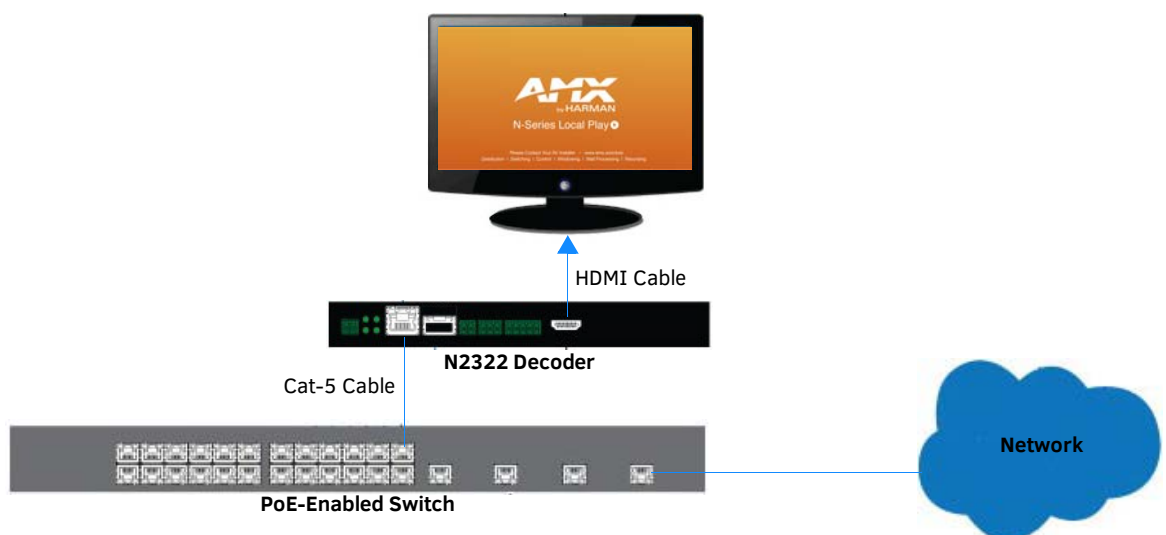

FIG. 9 Decoder Connections

- Repeat Steps 1 and 2 until all Decoders are installed on the network.

- Once the Decoders and displays are connected and powered up, the LocalPlay screen appears on the displays.

NOTE: If the LocalPlay screen does not appear, refer to the chapter [Troubleshooting on page 56](#) for more guidance.

NOTE: In order for the unit to receive PoE, it must be connected to a switch or other equipment that has a PoE PSE (Power Sourcing Equipment) port. PoE does not pass through the daisy chain (P1) port.

CAUTION: Do not run wiring that is connected to a PoE PSE port outside of the building where the PSE resides. It is for intra-building use only.

Step 3: Connecting Encoders to the Network and Configuring Stream Settings

- Using a Cat-5 cable, connect your N-Series Encoder's **PO** port to a PoE-enabled switch. In non-PoE applications connect a 12V regulated power supply (N9312) to the two-pin terminal block plug connector (labeled **+12V 2A**).

NOTE: In order for the unit to receive PoE, it must be connected to a switch or other equipment that has a PoE PSE port.

- In **N-Able**, select the **Unit Management** tab and click the **Auto Discover** button (if the table has not already populated itself with the installed units). See [Figure 10](#).

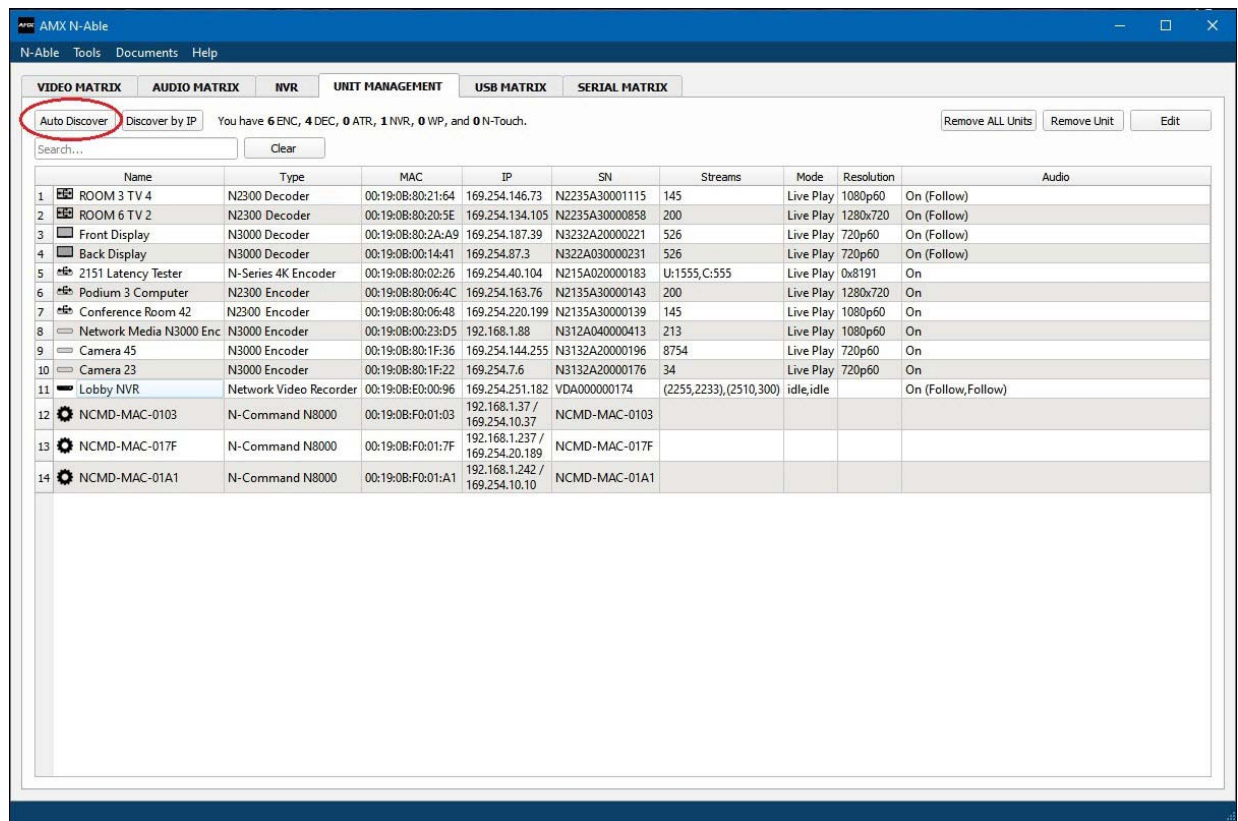

FIG. 10 Unit Management Page

- Find your Encoder in the list. N2300 units are displayed on the following tabs:
 - Unit Management** tab — N2300 units have **N2300 Encoder/Decoder** listed in their **Type** fields.
 - Video Matrix** tab — N2300 units are found on the **N2300** sub-tab (as shown in [Figure 11](#)).

NOTE: If using multiple Encoders in your set up, it is important to plug in and configure one Encoder at a time. All Encoders come pre-configured to use stream 2300. As you add Encoders to the network, you will need to set them up to use different streams.

Encoders are listed across the top of the page.

Decoders are listed down the left side of the page.

Red Text - No video source (Encoder) or no display (Decoder).
 Red Exclamation Point (!) - N-Able cannot communicate with device.
 Gray Text - Video network transmit for this unit is disabled.

Black Text - Unit is in live play mode.
Blue Text - Unit is playing locally-stored content.

FIG. 11 Video Matrix Page

- Double-click the Encoder's name in the list. The **Login** page is displayed (see [Figure 12](#)). If prompted, use the following default login credentials to log in for the first time. These can be changed later on the **Settings** page.
 Default username: **admin**
 Default password: **password**

FIG. 12 Login Page

NOTE: The Login page is only displayed if N-Able's stored username/password does not match the unit's username/password. A default system will match.

- The **Settings** page is displayed (see [Figure 13](#)).
- Change the **Stream** setting. We recommend setting **Stream** to a number between 2 and 254 (it is *required* that the number be less than 32,512).

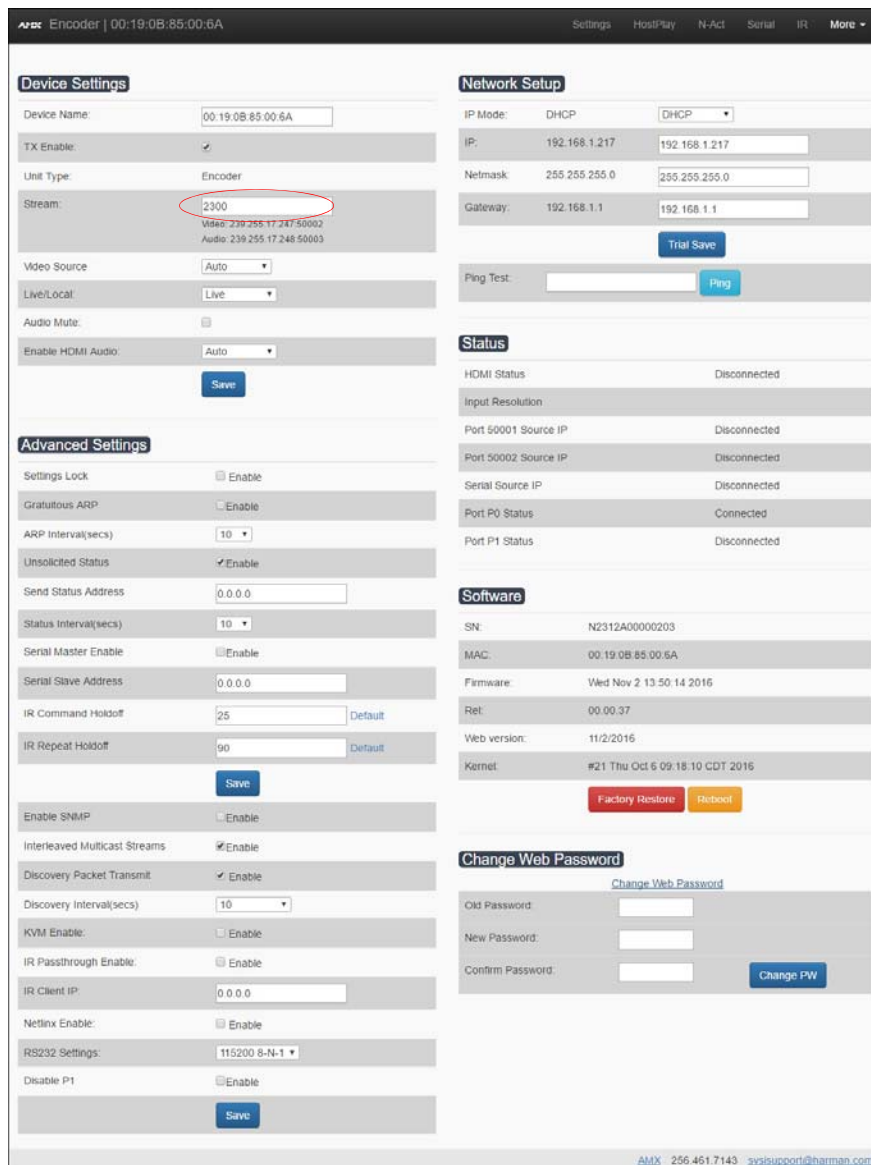

FIG. 13 Changing Stream Setting

7. Repeat these steps until all Encoders are connected to the network and configured with an appropriate **Stream** number.

NOTE: Each Encoder's Stream number must be unique to all other Encoders on the network.

NOTE: Screen-by-screen descriptions of the web interface options are provided for your reference in the [Encoder Configuration Options](#) section on page 23 and the [Decoder Configuration Options](#) section on page 39.

Step 4: Configuring Decoder and Encoder IP addresses (if needed)

By default, all Decoders and Encoders are preset to **DHCP** mode. When first connected to the network, an IP address is assigned automatically based on the network DHCP server. If no DHCP server is found, the unit will use **Auto IP** mode (with an IP address pre-configured to 169.254.xxx.xxx with a subnet mask of 255.255.0.0).

How IP Address Changes Affect Unit Control

As discussed previously, N-Able control is dependent upon the host computer being in the same IP address range as the N-Series devices. Therefore, before making any N2300 IP address changes, we recommend having **two statically-assigned IP addresses on your computer**.

- Configure the first IP address to be in the range of the default N-Series IP settings (i.e., in the 169.254.xxx.xxx range), AND
- Configure a second IP address in the range of the IP address you are planning to assign to the units (or when using DHCP, an address within the defined range for your network).

Changing IP Addresses

There are two ways to assign new IP addresses to your N2300 units using N-Able:

- **Option 1:** Log in to each unit individually and make the changes on the **Settings** page.
- **Option 2:** Export a comma-separated value (CSV) file, make changes to all units in the resulting file, and import the CSV file into N-Able to apply the changes.

Option 1: Assigning IP Addresses Individually (using the Settings page)

1. Find the unit you wish to change in the control matrix (either on the **Unit Management** tab or the **Video Matrix > N2300** tab).
2. Double-click the unit and log in.
3. Go to the **Settings** page and make IP address changes for that unit either by setting a **STATIC** address or by enabling **DHCP** (see [Figure 14](#)).

Network Setup		
IP Mode:	DHCP	<input type="text" value="DHCP"/>
IP:	192.168.1.217	<input type="text" value="192.168.1.217"/>
Netmask:	255.255.255.0	<input type="text" value="255.255.255.0"/>
Gateway:	192.168.1.1	<input type="text" value="192.168.1.1"/>
<input type="button" value="Trial Save"/>		
Ping Test:	<input type="text"/>	<input type="button" value="Ping"/>

FIG. 14 Network Setup Section of the Settings Page

4. Click the **Trial Save** button.
5. Return to the **Settings** page through the newly-configured IP address.
6. Once the **Settings** page appears (successfully using the new IP address) click the **Confirm** button to lock in your changes.

NOTE: If you lose communication for any reason, unplug the N2300, wait one minute, and plug it back in. This restores the unit to the original IP address.

Option 2: Assigning IP Addresses to Multiple Units (using CSV files)

N-Able has the ability to export and import CSV files. Once units are auto-discovered in N-Able, the CSV file can be exported into Excel where parameters such as IP address, subnet mask, gateway, stream number, audio settings, etc. can be configured. Once configured, import the CSV file back into N-Able to assign those parameters to the appropriate devices. Reboot the devices to activate the new settings. This procedure can be used to configure multiple networked AV devices at the same time. It can also provide valuable diagnostics by allowing you to see the last known device configuration as well as scan the network for new devices (regardless of IP configuration).

To configure units using a CSV file, follow these steps:

1. Make sure that you have performed an **Auto Discover** (on the **Unit Management** tab of N-Able) since connecting all of the new units to the network.
2. From N-Able's main menu bar, select **N-Able > Export CSV**.
3. Click **Yes** on the pop-up box informing you that a CSV file is about to be generated.

NOTE: A CSV file editor (e.g., Microsoft Excel) is necessary to proceed.

4. The folder containing your CSV file displays. Double-click the file to open it.
5. You can use this file to edit the IP mode, IP address, subnet mask, gateway IP address, stream number, etc. Once all changes have been made, save the file.
6. Go back into N-Able and select **N-Able > Import CSV**.
7. Browse to your saved CSV file and click **Import**.

Step 5: Connecting Encoders to an Input Source

Having already connected the Encoder(s) to the network and made the appropriate settings changes (as described in [Step 3](#) and [Step 4](#)), you can now connect to the appropriate AV source(s). This connection from an Encoder **HDMI IN** port (female) to an input source is accomplished using either an HDMI cable or DVI-I (through adapter).

1. Connect the source you would like to use for the Encoder (camera, laptop, etc.) to the Encoder's **HDMI IN** port using an HDMI cable. This connection can be digital or analog.
2. Repeat until all Encoders are connected to their sources.

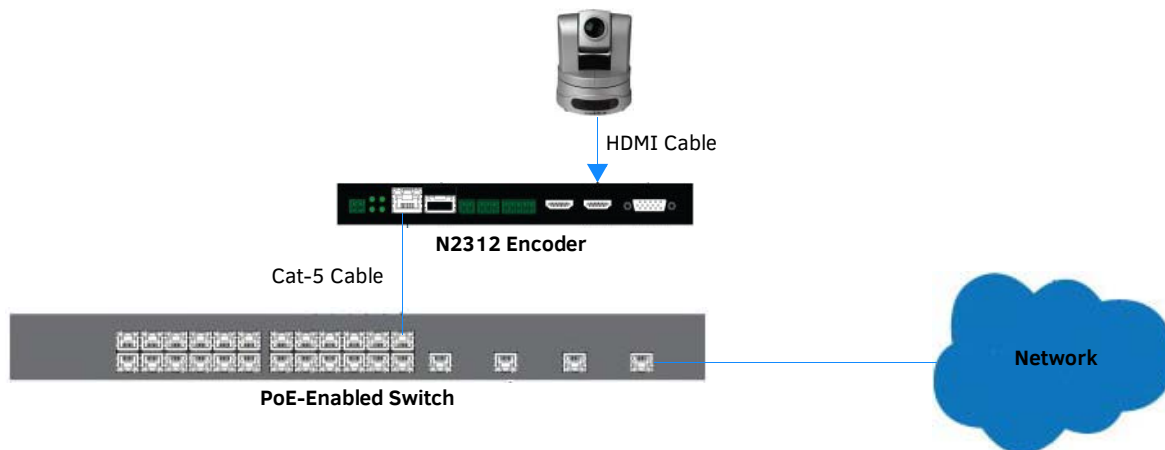

FIG. 15 Encoder Connection to Source

Switching and Scaling Options

N-Series Encoders and Decoders make up a true AV matrix solution. In other words, one input can go to any or all outputs.

Decoders have internal scaling capabilities. Keep the following in mind:

- The input of an Encoder is the video and/or audio signal going into the Encoder.
- The output of an Encoder is the network stream.
- The input of a Decoder is the network stream.
- The output of a Decoder is the digital video and/or audio being transmitted out to the display device.
- Upscaling is fully supported.
- Downscaling is supported only if the input is 3840x2160 and the Decoder scaler is set to 1080p50/60. Any other attempts at downscaling are not recommended/supported.

Seamless Switching

The N2300 Series supports seamless switching capability if the scalers in the Decoders are all set to the same resolution and refresh rate. If the scalers are off, all of the *sources* must have the same resolution and refresh rate.

To get streams onto a Decoder, use the **Video Matrix** tab to route video from an Encoder to a Decoder. This works seamlessly if the previously mentioned settings are true. All you have to do is click the common cell on the matrix, and click the **Take** button. See [Figure 16](#) for an example.

Enabling this cell causes the Decoder named **Conf Rm Dec** to listen to the Encoder named **Conference Rm Encoder**.

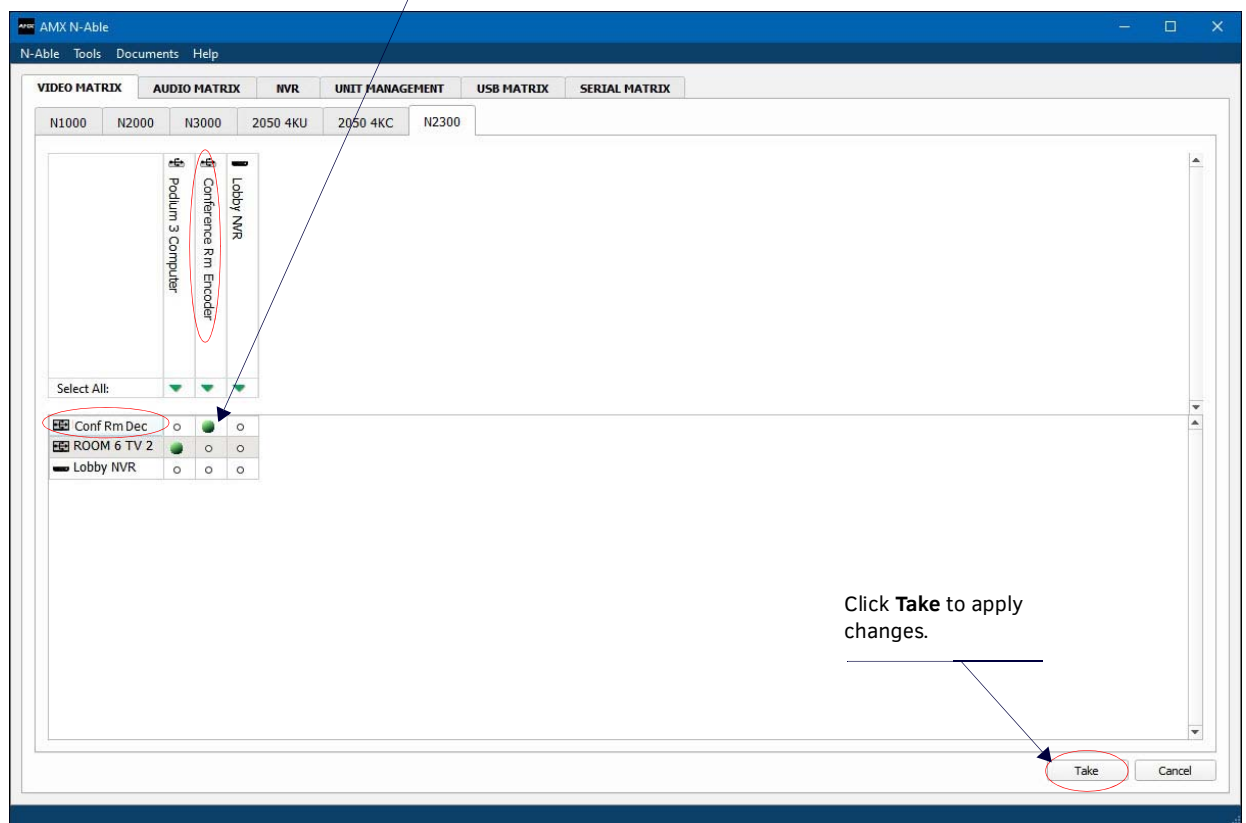

FIG. 16 Seamless Switching Using the Video Matrix

Control Options

For the most part, once the initial setup is complete, you will be primarily managing/configuring the Decoders. To better understand, think of Encoders as radio stations and Decoders as car radios. The Encoders are supplying the streams and, using the Decoders, you can “tune in” to the stream you want. N-Series’s N-Control solutions (N-Command, N-Act, and N-Touch) provide you with the most flexible management options available, insuring you are getting the most from your digital media system.

Primary Control Options

During initial configuration and setup, the free N-Able setup utility (version 2016.11.11 or higher) is sufficient. However, we do not recommend N-Able for production-level, primary-user control.

N-Command Controllers

These web-based hardware Controllers offer intuitive, powerful management of equipment, content, NVR recording/playback, bandwidth utilization, and AV switching (using a web-based, point-and-click graphical matrix). The N-Command product line also offers:

- Simplified ASCII interface for third-party control via TCP/IP.
- N8002 and N8012 controllers have master/slave failover protection.
- N8012 controller has hot-swappable drives and redundant power supplies.
- Graphical presentation of video network connections.
- Full configuration control: assign fixed IP addresses for each N-Series component, adjust variable bit-rate for each video stream, etc.
- Additional software bundles (free with N-Command) allow you to easily create attractive touch panels for N-Series and third-party equipment control, as well as build software design walls of any size. Visit our website for more details on the available N-Command Controllers.

Third-Party Controllers

The N2300 Series is capable of interfacing with third-party control systems such as Crestron. For direct control of N2300 units from any Third Party Control system, please use the Direct Control API (available on our website).

N-Act | On-Board, Built-In Control

All N-Series Encoders and Decoders have on-board, built-in control capability via events that can trigger any number of TCP/UDP commands to other IP controllable devices. Included free with all N-Series Encoders/Decoders. See the section [N-Act Page on page 32](#) for more information.

N-Touch | IP Wall Controller

This 240 x 320 capacitive touch display has Wi-Fi and Bluetooth for expanding control to mobile devices. Programming is done individually through the built-in web server or collectively to multiple units using an N-Command N8000 Series Controller. Multi-page custom graphics can be created using the free Panel Builder software (stored internally).

NetLinx

NetLinx Studio is commonly used by system programmers to streamline the integration, programming, organization, and support of their AMX equipment. As the cornerstone of AMX’s system design software tools, NetLinx Studio offers programmers the most flexible application capable of generating the most sophisticated code possible. Refer to [Appendix A: NetLinx Control on page 59](#) for more information.

KVM Configuration

The N2312 Encoders and N2322 Decoders are KVM-capable. By default, USB connections are disabled.

Basic Setup

Follow these steps for basic KVM configuration:

1. On the N2312 Encoder, connect the USB Mini-B port to the computer to be controlled.
2. Connect the computer's video output to the Encoder's **HDMI IN** port.
3. On the N2322 Decoder, connect the **HDMI OUT** to the display.
4. Connect a USB keyboard and mouse to the Decoder's USB Standard-A ports (they can be plugged into either port).

NOTE: For wireless devices, simply plug the wireless signal receivers into these ports. For keyboard and mouse combos (with a single connection) use the keyboard port.

5. Using N-Able, click the **Unit Management** tab.
6. Click the **Auto Discover** button to discover your new devices (if you have not already done so).
7. Once discovery is complete (and you see the new units listed in N-Able), click the **Video Matrix** tab.
8. On the matrix, click the common cell for the desired Encoder/Decoder streaming combination.
9. Click the **Take** button to make the change to your matrix. The radio button turns green to indicate the connection was successful.
10. Check the **KVM Enable** box on the Encoders and Decoders being used (this setting is found on the **Settings** page).
11. On the Decoder **Settings** page, enter the KVM Encoder's IP address (in the **KVM IP** field).

NOTE: Multiaccess is enabled by default, you can have multiple Decoders attached to a single Encoder. Simply go to each Decoder's Settings page and enable KVM and input the Encoder's IP address (or create the connection in N-Able, as described in the steps above).

Encoder Configuration Options

This chapter defines N2312 Encoder configuration options. For ease of navigation, it is organized to reflect the graphical user interface (GUI).

From any main page in the GUI, you can access all other main pages by clicking the links in the top navigation bar. [Figure 17](#) shows the navigation bar and provides hot links to the sections of this chapter which describe each main page.

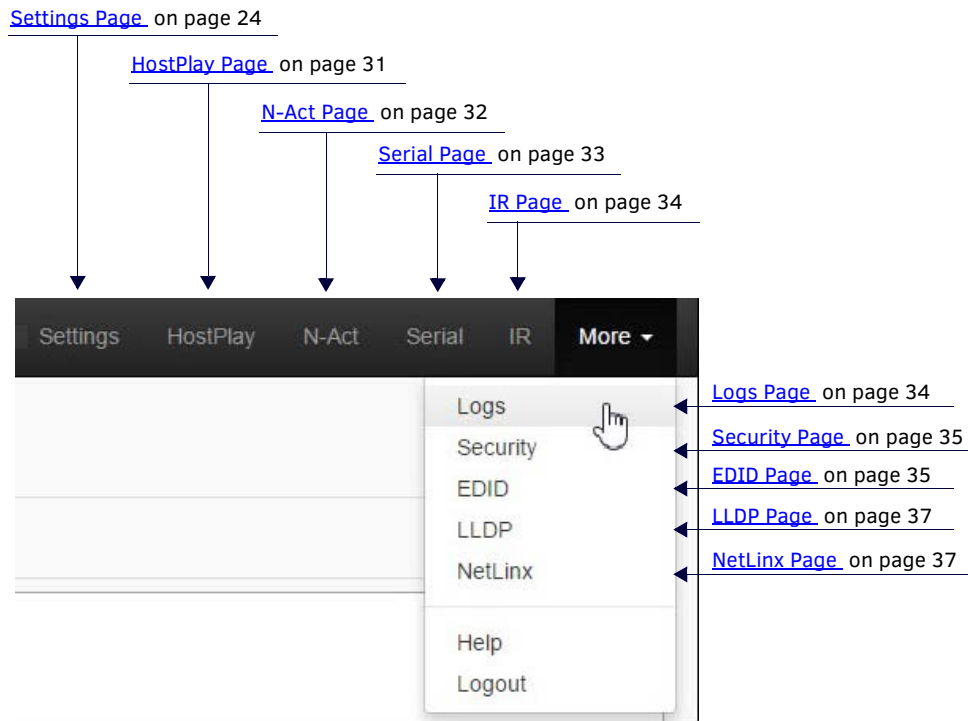

FIG. 17 Section Links

Settings Page

Click the **Settings** link at the top of any of the main web pages to access the page shown in [Figure 18](#). This page is divided into several sections and also has links to other dialog boxes for additional configuration options. Refer to the following sections for detailed descriptions:

- [Device Settings Section on page 25](#)
- [Advanced Settings on page 26](#)
- [Network Setup Section on page 28](#)
- [Status Section on page 29](#)
- [Software Section on page 30](#)
- [Change Web Password on page 30](#)

The screenshot shows the Settings page for an AMX Encoder. The top navigation bar includes links for Settings, HostPlay, N-Act, Serial, IR, and More. The Settings link is circled in red. The page is organized into several sections:

- Device Settings:** Includes fields for Device Name (00.19.0B.85.00.6A), TX Enable (checked), Unit Type (Encoder), Stream (2300), Video Source (Auto), Live/Local (Live), Audio Mute (unchecked), and Enable HDMI Audio (Auto). A Save button is at the bottom.
- Network Setup:** Includes IP Mode (DHCP), IP (192.168.1.217), Netmask (255.255.255.0), and Gateway (192.168.1.1). A Ping Test field and Ping button are also present. A Trial Save button is at the bottom.
- Advanced Settings:** Includes Settings Lock (unchecked), Gratuitous ARP (unchecked), ARP Interval (10), Unsolicited Status (checked), Send Status Address (0.0.0.0), Status Interval (10), Serial Master Enable (checked), Serial Slave Address (0.0.0.0), IR Command Holdoff (25), IR Repeat Holdoff (90), Enable SNMP (unchecked), Interleaved Multicast Streams (checked), Discovery Packet Transmit (checked), Discovery Interval (10), KVM Enable (unchecked), IR Passthrough Enable (checked), IR Client IP (0.0.0.0), Netlinx Enable (checked), RS232 Settings (115200 8-N-1), and Disable P1 (checked). A Save button is at the bottom.
- Status:** A table showing connection status for HDMI, Port 50001, Port 50002, Serial, Port P0, and Port P1.
- Software:** Displays system information including SN, MAC, Firmware, Ret, Web version, and Kernel. Factory Restore and Reboot buttons are at the bottom.
- Change Web Password:** A form with fields for Old Password, New Password, and Confirm Password, and a Change PW button.

The footer of the page contains the text: AMX 256.461.7143 sysisupport@harman.com

FIG. 18 Settings Page

Device Settings Section

The **Device Settings** section of the **Settings** page is shown in [Figure 19](#). Options are described in [Table 1](#).

The screenshot shows the 'Device Settings' form with the following values:

- Device Name: 00:19:0B:85:00:6A
- TX Enable:
- Unit Type: Encoder
- Stream: 2300
- Video: 239.255.17.247:50002
- Audio: 239.255.17.248:50003
- Video Source: Auto
- Live/Local: Live
- Audio Mute:
- Enable HDMI Audio: Auto

FIG. 19 Device Settings Section

TABLE 1 Settings Page: Device Settings Section

Option	Description	Notes
Device Name	Enter a user-friendly name for the unit.	More descriptive names in this field help you organize and manage the N-Series system efficiently. Names based on the unit's location and function are very useful. Some good examples are Lobby-Left-VGA (for left side of lobby, VGA input) or CR201-HDMI (for Conference Room 201, HDMI input). Keep in mind the matrices are organized alphanumerically.
TX Enable	Enable to broadcast the AV signals. Disable to turn off/stop broadcasting.	
Unit Type	Displays the unit type (Encoder or Decoder).	
Stream	View/edit the current transmit stream number.	To better understand this setting, think of Encoders more like a channel on a cable box, rather than a traditional AV Matrix. Each Encoder must have a unique stream number, just like every channel must have a unique channel number (e.g., Food Network and HGTV cannot both be on channel 201).
Video Source	Select which input port is encoding video. Choices are Auto , VGA only , and HDMI only .	Selecting VGA only or HDMI only disables the other video input port. Selecting Auto enables both video input ports. If both video source types are connected, you cannot define one or the other as the preferred source. Therefore, when in Auto mode (and both input types are plugged in) a preferred mode is undefined.
Live/Local	Select live video or locally stored images for transmission onto the network. When video is not available, it automatically goes into local mode.	When video is not available, the most recently played local playlist is displayed.
Audio Mute	Enable to stop the transmission of audio data onto the network.	
Enable HDMI Audio	Set HDMI audio to be disabled or selected automatically based on the source.	If set to AUTO , the audio follows the video source. If HDMI input is active, HDMI audio is active. If analog video is active, analog audio is active. If set to OFF , audio is disabled.
Save button	Click to save settings made in this section.	

Advanced Settings

The **Advanced Settings** section of the **Settings** page is shown in [Figure 20](#). Options are described in [Table 2](#).

The screenshot shows the 'Advanced Settings' page with the following options:

- Settings Lock: Enable
- Gratuitous ARP: Enable
- ARP Interval(secs): 10
- Unsolicited Status: Enable
- Send Status Address: 0.0.0.0
- Status Interval(secs): 10
- Serial Master Enable: Enable
- Serial Slave Address: 0.0.0.0
- IR Command Holdoff: 25 (Default)
- IR Repeat Holdoff: 90 (Default)
- Save button
- Enable SNMP: Enable
- Interleaved Multicast Streams: Enable
- Discovery Packet Transmit: Enable
- Discovery Interval(secs): 10
- KVM Enable: Enable
- IR Passthrough Enable: Enable
- IR Client IP: 0.0.0.0
- Netlinx Enable: Enable
- RS232 Settings: 115200 8-N-1
- Disable P1: Enable
- Save button

FIG. 20 Advanced Settings

TABLE 2 Settings Page: Advanced Settings

Option	Description	Notes
Settings Lock	Enable to lock the Encoder IP settings and stream number, preventing automated processes (from N-able or N-Command) from occurring.	This does <i>not</i> prevent a control system from making changes or a user from manually making changes.
Gratuitous ARP	Enable the Encoder to send a periodic Address Resolution Protocol (ARP) packet to the network.	
ARP Interval (secs)	Determine how often (in seconds) the unit transmits gratuitous ARP packets.	
Unsolicited Status	Enable the Encoder to send a periodic status packet to the Send Status Address described below.	
Send Status Address	When Unsolicited Status is enabled, the Encoder sends a periodic status packet to the IP address specified here.	

TABLE 2 Settings Page: Advanced Settings (Cont.)

Option	Description	Notes
Status Interval (secs)	Determine how often (in seconds) the unit transmits status packets.	
Serial Master Enable	Enable this device to be the master to the designated slave.	
Serial Slave Address	Enter the IP address of the serial slave device.	
IR Command Holdoff	Set the delay between IR command portions. The default setting is 25 ms.	IR commands are sent in two parts. This setting is the time (in milliseconds) between transmission of part one and part two. The second part of the command is inverted for confirmation purposes.
IR Repeat Holdoff	Set the repeat delay between IR commands. The default setting is 90 ms.	This is the amount of time before a new command is sent. For example, when pressing and holding the volume button on a remote control, this is how long until the command is repeated.
Save button	Click to save settings made in this portion of the Advanced section.	
Enable SNMP	Enable to allow the device to handle Simple Network Management Protocol (SNMP) queries.	
Interleaved Multicast Streams	Enables a multicast format which interleaves video and audio streams.	In order for N-Series devices to communicate with each other, their multicast settings must be compatible.
Discovery Packet Transmit	Enable the N-Series multicast discovery service (which is used to identify units).	This is useful for larger network integrations when broadcast packets will not cover the entire network. Enabled by default.
Discovery Interval (secs)	Determine how often (in seconds) the unit transmits discovery packets.	
KVM Enable	Enable to allow the ability to share mouse and keyboard over the network. Disabled by default. When disabled, the unit works like a non-KVM unit and ignores any keyboard or mouse activity.	
IR Passthrough Enable	Enables support for passing IR input data from one unit to the IR output on another.	This must be enabled on both the sender and receiver.
IR Client IP	Specifies the IP address of the unit to send IR passthrough data to.	
Netlinx Enable	Click to enable/disable NetLinx support on this device.	
RS232 Settings	Set the baud rate, data bits, parity, and stop bit for the RS232 serial interface.	
Disable P1	Completely disables the P1 port for all traffic.	Once disabled, anything connected to the P1 port will no longer be available on the network.
Save button	Click to save settings made in this portion of the Advanced section.	

Network Setup Section

The **Network Setup** section of the **Settings** page is shown in [Figure 21](#). Options are described in [Table 3](#).

The screenshot shows the 'Network Setup' section of a web interface. At the top, there is a title 'Network Setup' in a dark box. Below it, the 'IP Mode' is set to 'DHCP' with a dropdown menu. The 'IP' field contains '192.168.1.217', the 'Netmask' field contains '255.255.255.0', and the 'Gateway' field contains '192.168.1.1'. A blue 'Trial Save' button is positioned below these fields. At the bottom, there is a 'Ping Test' section with an input field and a blue 'Ping' button.

FIG. 21 Network Setup Section

TABLE 3 Settings Page: Network Setup Section

Option	Description	Notes
IP Mode	Configure the IP address mode. When set to AUTO IP , an IP Address in the range of 169.254.xxx.xxx with Netmask of 255.255.0.0 and Gateway address of 169.254.1.1 will be automatically assigned to the N2312 Encoder by the control software. When set to DHCP , an IP Address in the range of the DHCP server on the network will be automatically assigned to the N2312 Encoder. When set to STATIC , an IP address , Netmask , and Gateway address must be manually entered.	DHCP is the default setting. However, using DHCP beyond initial setup is generally not recommended. If the device is set to DHCP and fails to receive an address from the DHCP server in time, it will revert back to the AUTO IP Address (169.254.xxx.xxx) until the unit is rebooted.
IP	View the current IP address of the N2312 Encoder. When in STATIC mode, enter a new IP address into this field.	
Netmask	View the current Netmask of the N2312 Encoder. When in STATIC mode, enter a new Netmask into this field.	
Gateway	View the current Gateway address of the N2312 Encoder. When in STATIC mode, enter a new Gateway address into this field.	
Trial Save button	Click to initially save IP address changes. Once you log in to the unit using the new address, you will be able to confirm and accept the changes permanently.	
Ping Test/Ping button	Test connection by specifying an IP address or URL to ping. Click the Ping button to initiate the test.	

Status Section

The **Status** section of the **Settings** page is shown in [Figure 22](#). Options are described in [Table 4](#).

Status	
HDMI Status	Disconnected
Input Resolution	
Port 50001 Source IP	Disconnected
Port 50002 Source IP	Disconnected
Serial Source IP	Disconnected
Port P0 Status	Connected
Port P1 Status	Disconnected

FIG. 22 Status Section

TABLE 4 Settings Page: Status Section

Option	Description	Notes
HDMI Status	Indicates if a video source is connected to the Encoder.	
Input Resolution	Indicates the video resolution of the currently connected source.	
Port 50001 Source IP	Shows the IP address of the currently connected device or displays Disconnected if no connection exists.	Port 50001 can only accept a single external connection at a time. If a device is currently showing the port occupied (by a control system or other device), then other connections will be rejected. However, connection attempts from the same IP will override the current connection.
Port 50002 Source IP	Shows the IP address of the currently connected device or displays Disconnected if no connection exists.	Port 50002 can only accept a single external connection at a time. If a device is currently showing the port occupied (by a control system or other device), then other connections will be rejected. However, connection attempts from the same IP will override the current connection.
Serial Source IP	Shows the IP address of the currently connected device or displays Disconnected if no connection exists.	Only a single external connection can be accepted on the port. If a device is currently showing the port occupied (by a control system or other device), then other connections will be rejected. However, connection attempts from the same IP will override the current connection.
Port P0 Status	Shows the IP address of the currently connected device or displays Disconnected if no connection exists.	
Port P1 Status	Shows the IP address of the currently connected device or displays Disconnected if no connection exists.	

Software Section

The **Software** section of the **Settings** page is shown in [Figure 23](#). Options are described in [Table 5](#).

Software	
SN:	N2312A00000203
MAC:	00:19:0B:85:00:6A
Firmware:	Wed Nov 2 13:50:14 2016
Rel:	00.00.37
Web version:	11/2/2016
Kernel:	#21 Thu Oct 6 09:18:10 CDT 2016
<input type="button" value="Factory Restore"/> <input type="button" value="Reboot"/>	

FIG. 23 Software Section

TABLE 5 Settings Page: Software Section

Option	Description
SN	Displays the serial number of the N2312 Encoder.
MAC	Displays the MAC address of the network interface of the N2312 Encoder.
Firmware	Displays the date code for the currently running version of the N2312 Encoder internal firmware.
Rel	Displays the current software's release number.
Web version	Displays the date code for the currently running version of the web interface.
Kernel	Displays the current kernel revision.
Factory Restore button	Click to restore the device to the original factory settings. This resets everything except the IP address (including name, stream number, serial settings, etc.).
Reboot button	Click to reboot the device (does not affect current configuration).

Change Web Password

To change the web interface password, enter the current password in the field labeled **Old Password**, and enter a new password in the **New Password** and **Confirm Password** fields. Click **Change PW** to accept the new password.

Change Web Password

[Change Web Password](#)

Old Password:

New Password:

Confirm Password:

FIG. 24 Change Web Password

NOTE: This password needs to match N-Able's stored password to allow auto-login using N-Able.

HostPlay Page

Click the **HostPlay** link at the top of any of the main web pages to access the page shown in [Figure 25](#). This page allows you to upload new images to the Encoders and assign them to one of eight playlists. The designated playlist is shown on the display when no video is being transmitted or received. You can choose which playlist will display using the **Live/Local** option on the **Settings** page (see [Device Settings Section](#) on page 25). [Table 7](#) provides more information on **HostPlay** option descriptions.

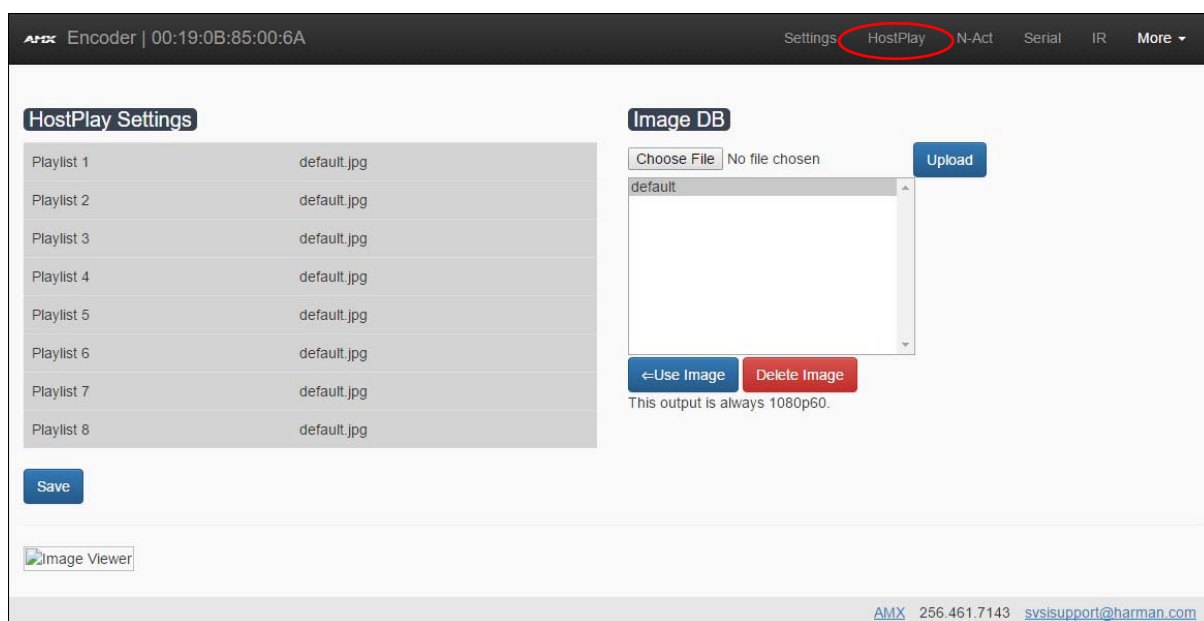

FIG. 25 HostPlay Page

TABLE 7 HostPlay Page Options

Option	Description
Playlists 1-8	View the images assigned to each of the eight PlayLists . On the Settings page (using the Live/Local drop-down box) you may designate which image/playlist will display when data transmission is not present.
Image DB	This section provides the ability to upload image and audio files to the N2312 Encoder database. Uploaded files appear in the corresponding list on the right of the page. Here you can choose to Use Image (at which point you are prompted to choose which of the eight playlists to assign the image to) or Delete Image .
Save button	Click to save settings made on this page.

N-Act Page

Click the **N-Act** link at the top of any of the main web pages to access the page shown in [Figure 26](#). This page allows you to create command lists which are performed automatically by the unit based on power or video connection (without the use of an outside controller). For example, you can tell a projector and lights to come on when the Encoder powers up. You can add multiple commands for each event. See [Table 8](#) for option descriptions.

FIG. 26 N-Act Page

TABLE 8 N-Act Page Options

Option	Description
Enable N-Act Events	Enable to activate the configured events.
Power on Event	Create/delete/test events to be performed when the Encoder powers on. Visit our website for more details on Application Programming Interface (API) commands.
Video Cable Connected Event	Create/delete/test events to be performed when the Encoder is connected to a video source. The Trigger Delay field specifies how long the device has to be connected for the command to be executed.
Video Cable Disconnected Event	Create/delete/test events to be performed when the Encoder is disconnected from a video source. The Trigger Delay field specifies how long the device has to be disconnected for the command to be executed. This keeps accidental (momentary) disconnects from triggering the command sequence.
Generic Events	Choose/create events to be performed when an XML change occurs, meaning a change in the state of a specific setting occurred. Choose which XML field to trigger. If a change occurs within the time frame, the event takes place. Commonly used to send an N-Act command if the stream number changes.
Save Events button	Click to save settings made on this page.

Serial Page

Click the **Serial** link at the top of any of the main web pages to access the page shown in [Figure 27](#). This page allows you to upload and execute commands used for direct control of serial devices. Commands may be saved for future use and executed later. The **Serial Code** menu lists all saved commands. See [Table 9](#) for option descriptions.

NOTE: *If the Port 5004/Serial Port is currently in use by another device, sending commands from the Serial page will always return a No Data message and fail to send the commands. Also, if NetLinx is enabled then the Serial web page (shown below) is inactive.*

FIG. 27 Serial Page

TABLE 9 Serial Page Options

Option	Description
Serial Code	Create/select serial commands. Different vendors have different codes that can usually be found through a web search. Copy/paste new commands (in either ASCII or HEX) directly into the appropriate input space.
Save button	Save the current code.
Delete button	Delete the current code.
Execute button	Apply the selected code to the Encoder's serial connection.
ASCII and HEX fields	Paste serial commands directly into either the ASCII or HEX field.
Response field	View responses provided by the device receiving the serial command(s).

IR Page

Click the **IR** link at the top of any of the main web pages to access the page shown in [Figure 28](#). This page allows you to upload and execute IR Pronto codes so that other vendor's devices can be controlled through the Encoder's IR connector. Commands can be saved for future use and executed later. The **IR Code** menu lists all saved IR commands. See [Table 10](#) for option descriptions.

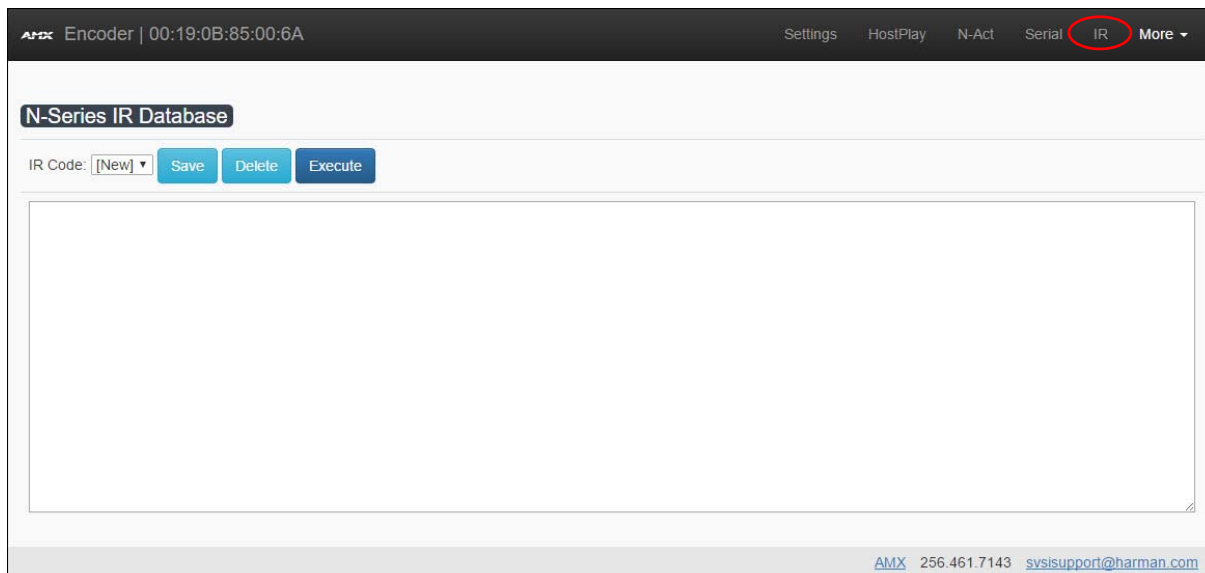

FIG. 28 IR Page

TABLE 10 IR Page Options

Option	Description
IR Code	Create/select IR codes. Different vendors have different IR Pronto codes and can usually be found through a web search. Copy/paste new IR commands directly into the input space.
Save button	Save the current code.
Delete button	Delete the current code.
Execute button	Activate the selected code through the Encoder's IR connector.

Logs Page

Click the **More** link at the top of any of the main web pages and select **Logs** to access the page shown in [Figure 29](#). The **Logs** page displays a command log that lists all TCP and UDP messages the unit receives. It also displays the web browser's IP address and gives you options to **Refresh** and **Reset Logs**. When in need of assistance from tech support, use the **Debug Log** section to capture information useful for troubleshooting. Simply click **Start Debug Log**, wait at least one minute, and click **End Debug Log** to create the file. You can then download and send it to tech support.

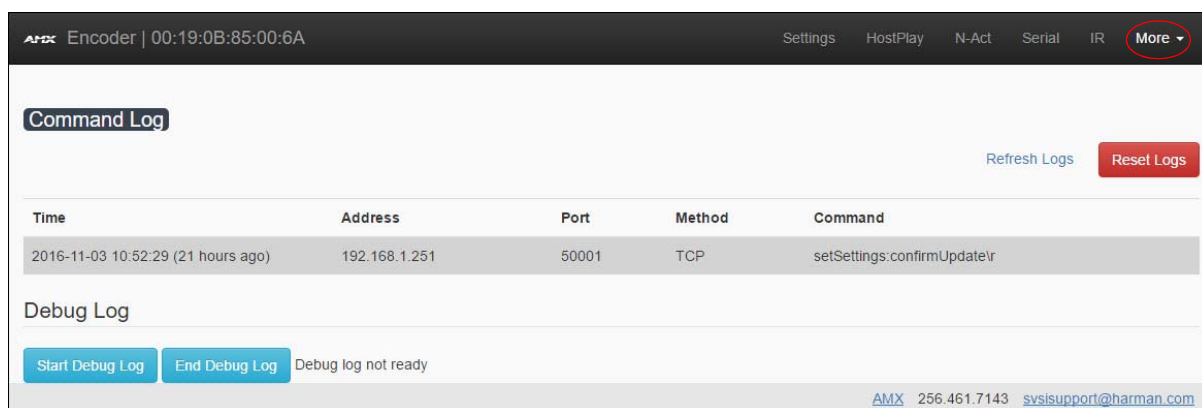

FIG. 29 Logs Page

Security Page

Click the **More** link at the top of any of the main web pages and select **Security** to access the page shown in [Figure 30](#). This page allows you to force HTTPS connections. To successfully communicate, the Decoder must know and match the Encoder password.



FIG. 30 Security Page

EDID Page

Click the **More** link at the top of any of the main web pages and select **EDID** to access the page shown in [Figure 31](#). Every display has stored information that it communicates to the output device. This page allows you to view the Encoder's EDID information. Options are described in [Table 11](#). Edit the Encoder's EDID if you need to change the display options available to the source.

NOTE: *There are sometimes delays when launching this page. Allow plenty of time before clicking any other links.*

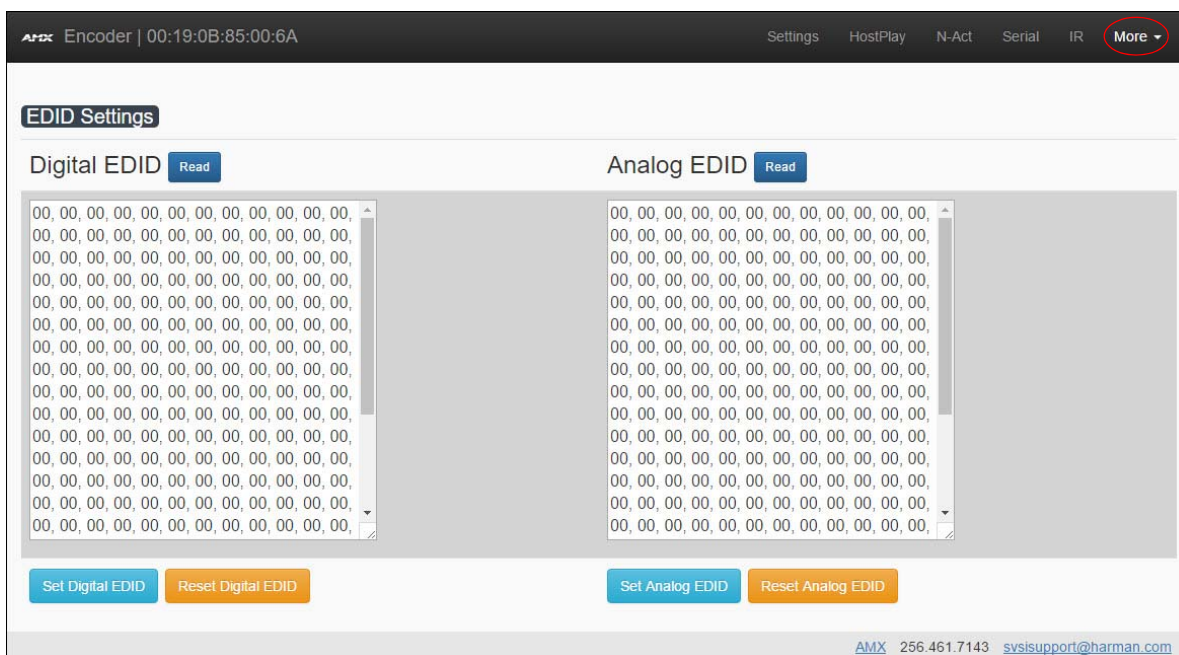

FIG. 31 EDID Page

TABLE 11 EDID Page Options

Option	Description
Digital EDID section	<p>Click the Read button to initially show the Encoder's local digital EDID information. This information is being provided to the source connected to the Encoder.</p> <p>You can modify the default digital EDID using an EDID captured from a display connected to a Decoder. Simply copy and paste the new EDID into the Digital EDID field and click the Set Digital EDID button. This overwrites the existing EDID. To return to the Encoder's default, click Reset Digital EDID.</p> <p>NOTE: <i>The source will need to be disconnected while modifying EDID settings.</i></p>
Analog EDID section	<p>Click the Read button to initially show the Encoder's local analog EDID information. This information is being provided to the source connected to the Encoder.</p> <p>If you modify the default analog EDID information provided by the Encoder, simply copy and paste the new EDID into the Analog EDID field and click the Set Analog EDID button. To return to the Encoder's default, click Reset Analog EDID.</p> <p>NOTE: <i>The source will need to be disconnected while modifying EDID settings.</i></p>

LLDP Page

Click the **More** link at the top of any of the main web pages and select **LLDP** to access the page shown in [Figure 32](#). The **LLDP** page displays information from the Link Layer Discover Protocol (LLDP) packet which identifies the port number and switch the device is connected to.

FIG. 32 LLDP Page

NetLinX Page

Click the **More** link at the top of any of the main web pages and select **NetLinX** to access the page shown in [Figure 33](#). Options are described in [Table 12](#). This page allows you to prepare your N2312 Encoder for NetLinX-driven configuration. This is explained in more detail in [Appendix A: NetLinX Control](#) on page 29.

NOTE: *NetLinX takes over the Serial port when active.*

FIG. 33 NetLinX Page

TABLE 12 NetLinX Page Options

Command	Description
Enable	Click to enable/disable NetLinX on this device.
Device Status	This status field will show the device to be Online , Connected , Offline , or Unknown .
Master Mode	Select Auto , Listen , or URL .
IP/URL	Enter the address of the Master Controller.

TABLE 12 NetLinx Page Options (Cont.)

Command	Description
Port	This field should always be set to 1319 .
Device Number	Defaults to a dynamic device number. May be set to a static range (e.g., 8000).
System Number	Determines which system to connect. This setting is dependent upon the Master Mode selected (see above). <ul style="list-style-type: none"> • If Master Mode is set to Auto, the System Number is set and the system discovers the Master Controller's IP address. • If Master Mode is set to Listen, the device connects to any Master Controller. • If Master Mode is set to URL, the IP of the Master Controller is set.
Username	Username for the Master Controller.
Password	Password for the Master Controller.
Save button	Click to save settings made on this page.

Decoder Configuration Options

This chapter defines N2322 Decoder configuration options. For ease of navigation, it is organized to reflect the graphical user interface (GUI).

As explained previously in the [Encoder Configuration Options section on page 23](#), you can access the GUI main pages by clicking the links in the top navigation bar. [Figure 34](#) shows the navigation bar and provides hot links to the sections of this chapter which describe each main page.

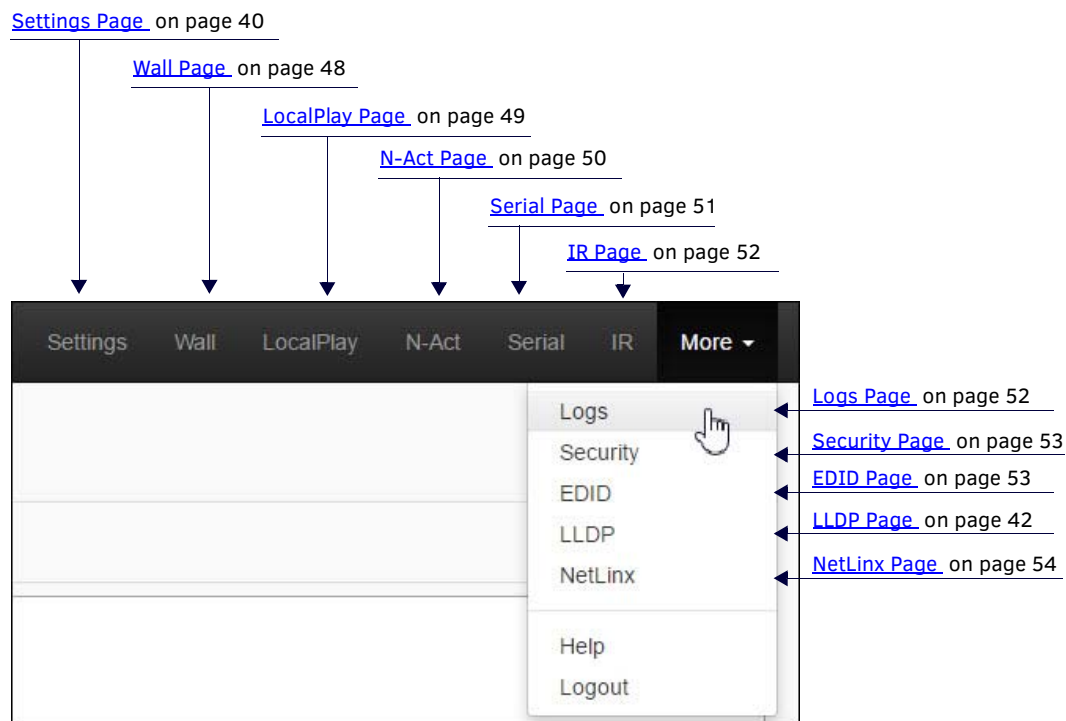

FIG. 34 Section Links

Settings Page

Click the **Settings** link at the top of any of the main web pages to access the page shown in [Figure 35](#). This page is divided into several sections and also has links to other dialog boxes for additional configuration options. Refer to the following sections for detailed descriptions:

- [Device Settings Section on page 41](#)
- [Advanced Settings on page 42](#)
- [Network Setup Section on page 45](#)
- [Status Section on page 46](#)
- [Software Section on page 47](#)
- [Change Web Password on page 47](#)

The screenshot shows the AMX Decoder web interface with the 'Settings' page selected. The page is organized into several sections:

- Device Settings:** Includes fields for Device Name (00:19:0B:85:01:1E), Unit Type (Decoder), Stream (2300), Video (239.255.17.247:50002), Audio (239.255.17.248:50003), Audio Stream (0), Audio Follows Video (checked), Scaler (unchecked), Output Mode (720p60), Live/Local (Live), Audio Mute (unchecked), and Lineout Volume (slider). A 'Save' button is at the bottom.
- Network Setup:** Includes IP Mode (STATIC), IP (169.254.145.23), Netmask (255.255.0.0), and Gateway (169.254.1.1). A 'Ping Test' field and 'Ping' button are also present. A 'Trial Save' button is at the bottom.
- Advanced Settings:** Includes Settings Lock (unchecked), YCBCR 4:2:2 Output (Auto), HDMI Off On Stream Loss (unchecked), HDMI Enable (checked), Gratuitous ARP (unchecked), ARP Interval (10), Unselected Status (checked), Send Status Address (0.0.0.0), Status Interval (10), Serial Master Enable (unchecked), Serial Slave Address (0.0.0.0), IR Command Holdoff (25), IR Repeat Holdoff (90), IGMP Joins on Stream Loss (checked), IGMP Join Interval (5), Enable SNMP (unchecked), Interleaved Multicast Streams (checked), Discovery Packet Transmit (checked), Discovery Interval (10), KVM Enable (unchecked), KVM IP (0.0.0.0), IR Passthrough Enable (unchecked), IR Client IP (0.0.0.0), Netlix Enable (unchecked), RS232 Settings (115200 8-N-1), and Disable P1 (unchecked). A 'Save' button is at the bottom.
- Status:** Shows HDMI Status (Disconnected), Input Resolution, Port 50001 Source IP (Disconnected), Port 50002 Source IP (Disconnected), Serial Source IP (Disconnected), Port FO Status (Connected), and Port P1 Status (Disconnected).
- Software:** Shows SN (N2322A00000183), MAC (00:19:0B:85:01:1E), Firmware (Wed Nov 2 13:50:14 2016), Ret (00:00:37), Web version (11/2/2016), and Kernel (#30 Thu Oct 6 09:09:13 CDT 2016). 'Factory Restore' and 'Reboot' buttons are at the bottom.
- Change Web Password:** Includes fields for Old Password, New Password, and Confirm Password. A 'Change PW' button is at the bottom.

The page footer contains the text: AMX 256.461.7143 sysupport@shaman.com

FIG. 35 Settings Page

Device Settings Section

The **Device Settings** section of the **Settings** page is shown in [Figure 36](#). Options are described in [Table 13](#).

The screenshot shows the 'Device Settings' form with the following values:

- Device Name: 00:19:0B:85:01:1E
- Unit Type: Decoder
- Stream: 2300
- Video: 239.255.17.247:50002
- Audio: 239.255.17.248:50003
- Audio Stream: 0
- Audio Follows Video:
- Scaler: Enable
- Output Mode: 720p60
- Live/Local: Live
- Audio Mute:
- Lineout Volume: A slider control.
- Save button: A blue button at the bottom.

FIG. 36 Device Settings Section

TABLE 13 Settings Page: Device Settings Section

Option	Description	Notes
Device Name	Enter a user-friendly name for the unit.	More descriptive names in this field help you organize and manage the N-Series system efficiently. Names based on the unit's location and function are very useful. Some good examples are Lobby-Left-VGA (for left side of lobby, VGA input) or CR201-HDMI (for Conference Room 201, HDMI input). Keep in mind the matrices are organized alphanumerically.
Unit Type	Displays the unit type (Encoder or Decoder).	
Stream	View/edit the current transmit stream number.	To better understand this setting, think of Decoders dialing up channels on a cable box, rather than a traditional AV matrix. Each decoder can dial in a different active channel.
Audio Stream	View/edit the current audio receive stream number.	
Audio Follows Video	Enable to force the Audio Stream to the same as the video stream.	
Scaler	Enable to scale outgoing content to a fixed resolution.	
Output Mode	Select the output resolution of the video to be transmitted to the video output device (e.g., LCD). The Scaler check box must be enabled for this to be applicable.	Downscaling is supported only if the input is 3840x2160 and the Decoder scaler is set to 1080p50/60. Any other attempts at downscaling are not recommended/supported.
Live/Local	Select live video or locally stored images for transmission to the video output device (e.g., LCD). When video is not available, it automatically goes into local mode.	When video is not available, the most recently played local playlist is displayed.
Audio Mute	Enable to mute output audio.	
Lineout Volume	This slider controls the output gain on the analog audio output. By default, it controls both the left and right lineout channels.	
Save button	Click to save settings made in this section.	

Advanced Settings

The **Advanced Settings** section of the **Settings** page is shown in [Figure 37](#). Options are described in [Table 14](#).

FIG. 37 Advanced Settings

TABLE 14 Settings Page: Advanced Settings

Option	Description	Notes
Settings Lock	Enable to lock the Decoder IP settings and stream number, preventing automated processes (from N-Able or N-Command) from occurring.	This does <i>not</i> prevent a control system from making changes or a user from manually making changes.
YCbCr 4:2:2 Output	Set YCbCr output to be disabled, enabled, or selected automatically based on the connected display.	

TABLE 14 Settings Page: Advanced Settings (Cont.)

Option	Description	Notes
HDMI Off On Stream Loss	Select to disable the video output drive when the video stream is not available.	
HDMI Enable	Select to enable output video.	
Gratuitous ARP	Enable the Decoder to send a periodic Address Resolution Protocol (ARP) packet to the network.	
ARP Interval (secs)	Determine how often (in seconds) the unit transmits gratuitous ARP packets.	
Unsolicited Status	Enable the Decoder to send a periodic status packet to the Send Status Address described below.	
Send Status Address	When Unsolicited Status is enabled, the Decoder sends a periodic status packet to the IP address specified here.	
Status Interval (secs)	Determine how often (in seconds) the unit transmits status packets.	
Serial Master Enable	Enable this device to be the master to the designated slave.	
Serial Slave Address	Enter the IP address of the serial slave device.	
IR Command Holdoff	Set the delay between IR command portions. The default setting is 25 ms.	IR commands are sent in two parts. This setting is the time (in milliseconds) between transmission of part one and part two. The second part of the command is inverted for confirmation purposes.
IR Repeat Holdoff	Set the repeat delay between IR commands. The default setting is 90 ms.	This is the amount of time before a new command is sent. For example, when pressing and holding the volume button on a remote control, this is how long until the command is repeated.
IGMP Joins on Stream Loss	Enable to send Internet Group Management Protocol (IGMP) join messages when no incoming stream is detected.	
IGMP Join Interval	Delay in seconds between sending IGMP join messages (if IGMP Joins on Stream Loss is enabled).	
Save button	Click to save settings made in this portion of the Advanced section.	
Enable SNMP	Enable to allow the device to send Simple Network Management Protocol (SNMP) packets.	
Interleaved Multicast Streams	Enables a multicast format which interleaves video and audio streams.	In order for N-Series devices to communicate with each other, their multicast settings must be compatible.
Discovery Packet Transmit	Enable the N-Series multicast discovery service (which is used to identify units).	This is useful for larger network integrations when broadcast packets will not cover the entire network. Enabled by default.
Discovery Interval (secs)	Determine how often (in seconds) the unit transmits discovery packets.	
KVM Enable	Enable to allow the ability to share mouse and keyboard over the network. Disabled by default. When disabled, the unit works like a non-KVM unit and ignores any keyboard or mouse activity.	
KVM IP	View/edit the IP address of the KVM Encoder currently connected to this Decoder.	
IR Passthrough Enable	Enables support for passing IR input data from one unit to the IR output on another.	This must be enabled on both the sender and receiver.
IR Client IP	Specifies the IP address of the unit to send IR passthrough data to.	
Netlinx Enable	Click to enable/disable NetLinx support on this device.	
RS232 Settings	Set the baud rate, data bits, parity, and stop bit for the RS232 serial interface.	

TABLE 14 Settings Page: Advanced Settings (Cont.)

Option	Description	Notes
Disable P1	Completely disables the P1 port for all traffic.	Once disabled, anything connected to the P1 port will no longer be available on the network.
Save button	Click to save settings made in this portion of the Advanced section.	

Network Setup Section

The **Network Setup** section of the **Settings** page is shown in [Figure 38](#). Options are described in [Table 15](#).

The screenshot shows the 'Network Setup' section of a web interface. It includes a dropdown menu for 'IP Mode' set to 'STATIC'. Below are input fields for 'IP' (169.254.145.23), 'Netmask' (255.255.0.0), and 'Gateway' (169.254.1.1). A blue 'Trial Save' button is positioned below these fields. At the bottom, there is a 'Ping Test' section with a text input field and a blue 'Ping' button.

FIG. 38 Network Setup Section

TABLE 15 Settings Page: Network Setup Section

Option	Description	Notes
IP Mode	Configure the IP address mode. When set to AUTO IP , an IP Address in the range of 169.254.xxx.xxx with Netmask of 255.255.0.0 and Gateway address of 169.254.1.1 will be automatically assigned to the N2322 Decoder by the control software. When set to DHCP , an IP Address in the range of the DHCP server on the network will be automatically assigned to the N2322 Decoder Decoder. When set to STATIC , an IP address , Netmask , and Gateway address must be manually entered.	DHCP is the default setting. However, using DHCP beyond initial setup is generally not recommended. If the device is set to DHCP and fails to receive an address from the DHCP server in time, it will revert back to the AUTO IP Address (169.254.xxx.xxx) until the unit is rebooted.
IP	View the current IP address of the N2322 Decoder. When in STATIC mode, enter a new IP address into this field.	
Netmask	View the current Netmask of the N2322 Decoder. When in STATIC mode, enter a new Netmask into this field.	
Gateway	View the current Gateway address of the N2322 Decoder. When in STATIC mode, enter a new Gateway address into this field.	
Trial Save button	Click to initially save IP address changes. Once you log in to the unit using the new address, you will be able to confirm and accept the changes permanently.	
Ping Test/Ping button	Test connection by specifying an IP address or URL to ping. Click the Ping button to initiate the test.	

Status Section

The **Status** section of the **Settings** page is shown in [Figure 39](#). Options are described in [Table 16](#).

Status	
HDMI Status	Disconnected
Input Resolution	
Port 50001 Source IP	Disconnected
Port 50002 Source IP	Disconnected
Serial Source IP	Disconnected
Port P0 Status	Connected
Port P1 Status	Disconnected

FIG. 39 Status Section

TABLE 16 Settings Page: Status Section

Option	Description	Notes
HDMI Status	Indicates if a monitor is connected.	
Input Resolution	Indicates the video resolution of the incoming video source.	
Port 50001 Source IP	Shows the IP address of the currently connected device or displays Disconnected if no connection exists.	Port 50001 can only accept a single external connection at a time. If a device is currently showing the port occupied (by a control system or other device), then other connections will be rejected. However, connection attempts from the same IP will override the current connection.
Port 50002 Source IP	Shows the IP address of the currently connected device or displays Disconnected if no connection exists.	Port 50002 can only accept a single external connection at a time. If a device is currently showing the port occupied (by a control system or other device), then other connections will be rejected. However, connection attempts from the same IP will override the current connection.
Serial Source IP	Shows the IP address of the currently connected device or displays Disconnected if no connection exists.	Only a single external connection can be accepted on the port. If a device is currently showing the port occupied (by a control system or other device), then other connections will be rejected. However, connection attempts from the same IP will override the current connection.
Port P0 Status	Shows the IP address of the currently connected device or displays Disconnected if no connection exists.	
Port P1 Status	Shows the IP address of the currently connected device or displays Disconnected if no connection exists.	

Software Section

The **Software** section of the **Settings** page is shown in [Figure 40](#). Options are described in [Table 17](#).

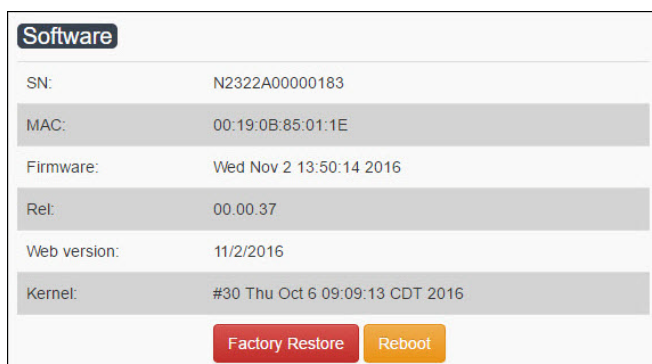

Software	
SN:	N2322A00000183
MAC:	00:19:0B:85:01:1E
Firmware:	Wed Nov 2 13:50:14 2016
Rel:	00.00.37
Web version:	11/2/2016
Kernel:	#30 Thu Oct 6 09:09:13 CDT 2016
<input type="button" value="Factory Restore"/> <input type="button" value="Reboot"/>	

FIG. 40 Software Section

TABLE 17 Settings Page: Software Section

Option	Description
SN	Displays the serial number of the N2322 Decoder.
MAC	Displays the MAC address of the network interface of the N2322 Decoder.
Firmware	Displays the date code for the currently running version of the N2322 Decoder internal firmware.
Rel	Displays the current software's release number.
Web version	Displays the date code for the currently running version of the web interface.
Kernel	Displays the current kernel revision.
Factory Restore button	Click to restore the device to the original factory settings. This resets everything except the IP address (including name, stream number, serial settings, etc.).
Reboot button	Click to reboot the device (does not affect current configuration).

Change Web Password

To change the web interface password, enter the current password in the field labeled **Old Password**, and enter a new password in the **New Password** and **Confirm Password** fields. Click **Change PW** to accept the new password.

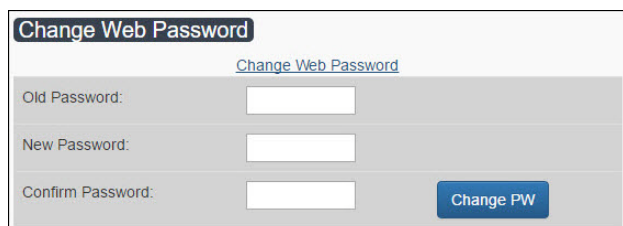

Change Web Password	
Change Web Password	
Old Password:	<input type="password"/>
New Password:	<input type="password"/>
Confirm Password:	<input type="password"/>
<input type="button" value="Change PW"/>	

FIG. 41 Change Web Password

NOTE: This password needs to match N-Able's stored password to allow auto-login using N-Able.

Wall Page

Click the **Wall** link at the top of any of the main web pages to access the page shown in [Figure 42](#). This page allows you to create video walls made up of the output from multiple Decoders. See [Table 20](#) for option descriptions.

The screenshot shows the 'Wall Setup' page in the AMX Decoder interface. The page title is 'Decoder | 00:19:0B:85:01:1E'. The navigation menu includes 'Settings', 'Wall' (highlighted with a red circle), 'LocalPlay', 'N-Act', 'Serial', 'IR', and 'More'. The 'Wall Setup' section contains the following options:

- Enable Wall:** A checkbox that is currently unchecked.
- Wall Stretch:** A dropdown menu set to 'auto'.
- Parameters:** Two dropdown menus for 'Rows' (set to 1) and 'Columns' (set to 1).
- Bezel Adjust:** Two dropdown menus for 'Horz Shift' (set to 0) and 'Vert Shift' (set to 0).

Below the settings, the text 'Position in Wall: 0, 0' is displayed. A yellow rectangle represents the decoder's position in the wall, with '0,0' centered inside it. At the bottom left, there are 'Save' and 'Cancel' buttons. At the bottom right, the contact information 'AMX 256.461.7143 sysisupport@harman.com' is visible.

FIG. 42 Wall Page

TABLE 20 Wall Page Options

Option	Description
Enable Wall	Check this box to enable wall processing.
Wall Stretch	Choose how a video is scaled to the wall area: auto: Decoder decides the best scaling method. fit: Fits the video to the wall area, changing the aspect ratio as needed. stretch: Stretches the video to fill the wall, maintaining the aspect ratio and cropping as needed.
Parameters	Choose the position that this Decoder will have in the video wall (by row and column).
Bezel Adjust	Set the bezel adjustment on the left edge (Horz Shift) and the top edge (Vert Shift) in 8840x2160 measured pixels.
Position in Wall	Displays the current position of this Decoder in the video wall.
Save button	Click to save settings made on this page.
Cancel button	Return settings to the last saved configuration.

LocalPlay Page

Click the **LocalPlay** link at the top of any of the main web pages to access the screen shown in [Figure 43](#). This page allows you to upload new images to the Decoders and assign them to one of eight playlists. The designated playlist is shown on the display when no video is being transmitted or received. You can choose which playlist will display using the **Live/Local** option on the **Settings** page (see [Device Settings Section](#) on page 41). See [Table 21](#) for option descriptions.

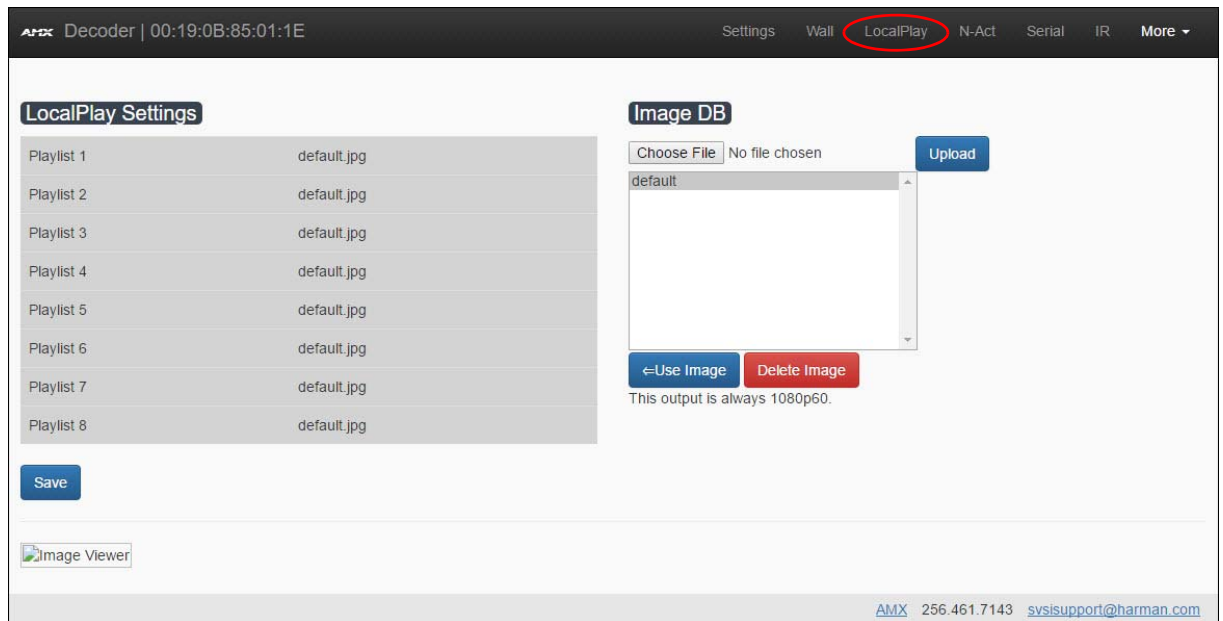

FIG. 43 LocalPlay Page

TABLE 21 LocalPlay Page Options

Option	Description
Playlist 1-8	View the images assigned to each of the eight PlayLists . On the Settings page (using the Live/Local drop-down box) you may designate which image/playlist will display when data transmission is not present.
Image DB	This section provides the ability to upload image and audio files to the N2322 Decoder database. Uploaded files appear in the corresponding list on the right of the page. Here you can choose to Use Image (at which point you are prompted to choose which of the eight playlists to assign the image to) or Delete Image .
Save button	Click to save settings made on this page.

N-Act Page

Click the **N-Act** link at the top of any of the main web pages to access the page shown in [Figure 44](#). This page allows you to create command lists which are performed automatically by the unit based on power or video connection (without the use of an outside controller). For example, you can tell a projector and lights to come on when the Decoder powers up. You can add multiple commands for each event. See [Table 22](#) for option descriptions.

AMX Decoder | 00:19:0B:85:01:1E

Settings Wall LocalPlay **N-Act** Serial IR More ▾

- N-Act Events must first be enabled. See check box below.
- SVSI N-Series use TCP ASCII or UDP ASCII port 50002 for control.
- Conductor N8000s accept script commands on TCP ASCII port 50020.
- All control commands are terminated by a carriage return '\r'.
- SVSI N-Series use TCP HEX port 50004 for serial.
- The SVSI N-Series Serial page has an ASCII/HEX Converter.
- Trigger Delay can be 0 to 86400 seconds (24 hours).
- After the Trigger Delay, each command is executed in order with a Delay (sec) between each command.
- Macros are supported in ASCII mode with the {{name}} notation (case-sensitive). Upon execution, Current value will be substituted.
- Encoder Hostplay does not trigger connect/disconnect events unless in live mode.

Enable N-Act Events

Power On Event Test

Protocol: TCP ASCII Address: 127.0.0.1 Port: 50003 Data: Data Delay (sec): 1 Delete

Add new...

Video Cable Connected Event Trigger Delay: 0 Test

Protocol: TCP ASCII Address: 127.0.0.1 Port: 50003 Data: Data Delay (sec): 1 Delete

Add new...

Video Cable Disconnected Event Trigger Delay: 0 Test

Protocol: TCP ASCII Address: 127.0.0.1 Port: 50003 Data: Data Delay (sec): 1 Delete

Add new...

Generic Events stream Add Generic Event

Save Events

AMX 256.461.7143 svsisupport@harman.com

FIG. 44 N-Act Page

TABLE 22 N-Act Page Options

Option	Description
Enable N-Act Events	Enable to activate the configured events.
Power on Event	Create/delete/test events to be performed when the Decoder powers on. Visit our website for more details on Application Programming Interface (API) commands.
Video Cable Connected Event	Create/delete/test events to be performed when the Decoder is connected to an output display. The Trigger Delay field specifies how long the device has to be connected for the command to be executed.
Video Cable Disconnected Event	Create/delete/test events to be performed when the Decoder is disconnected from the output display. The Trigger Delay field specifies how long the device has to be disconnected for the command to be executed. This keeps accidental (momentary) disconnects from triggering the command sequence.
Generic Events	Choose/create events to be performed when an XML change occurs, meaning a change in the state of a specific setting occurred. Choose which XML field to trigger. If a change occurs within the time frame, the event takes place. Commonly used to send an N-Act command if the stream number changes.
Save Events button	Click to save settings made on this page.

Serial Page

Click the **Serial** link at the top of any of the main web pages to access the page shown in [Figure 45](#). This page allows you to upload and execute commands used for direct control of serial devices. Commands may be saved for future use and executed later. The **Serial Code** menu lists all saved commands. See [Table 23](#) for option descriptions.

NOTE: *If the Port 5004/Serial Port is currently in use by another device, sending commands from the Serial page will always return a No Data message and fail to send the commands. Also, if NetLinX is enabled then the Serial web page (shown below) is inactive.*

FIG. 45 Serial Page

TABLE 23 Serial Page Options

Option	Description
Serial Code	Create/select serial commands. Different vendors have different codes that can usually be found through a web search. Copy/paste new commands (in either ASCII or HEX) directly into the appropriate input space.
Save button	Save the current code.
Delete button	Delete the current code.
Execute button	Send the selected code out the Decoder's serial connection.
ASCII and HEX fields	Paste serial commands directly into either the ASCII or HEX field.
Response field	View responses provided by the device receiving the serial command(s).

IR Page

Click the **IR** link at the top of any of the main web pages to access the page shown in [Figure 46](#). This page allows you to upload and execute IR Pronto codes so that other vendor's devices can be controlled through the Decoder's IR connector. Commands can be saved for future use and executed later. The **IR Code** menu lists all saved IR commands. See [Table 24](#) for option descriptions.

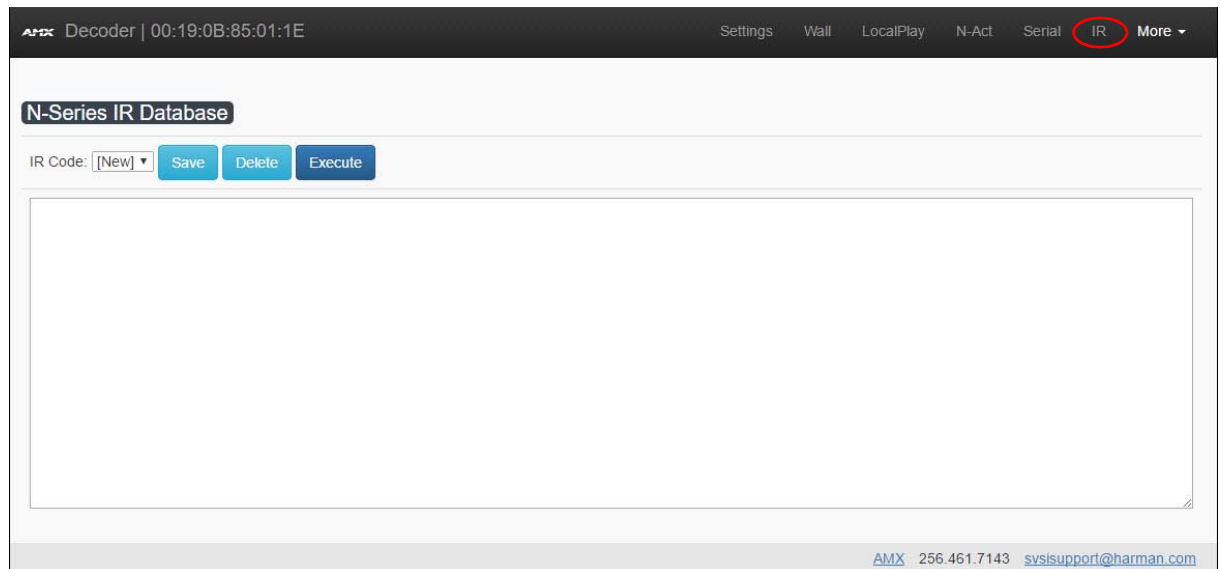

FIG. 46 IR Page

TABLE 24 IR Page Options

Option	Description
IR Code	Create/select IR codes. Different vendors have different IR Pronto codes and can usually be found through a web search. Copy/paste new IR commands directly into the input space.
Save button	Save the current code.
Delete button	Delete the current code.
Execute button	Activate the selected code through the Decoder's IR connector.

Logs Page

Click the **More** link at the top of any of the main web pages and select **Logs** to access the page shown in [Figure 47](#). The **Logs** page displays a command log that lists all TCP and UDP messages the unit receives. It also displays the web browser's IP address and gives you options to **Refresh** and **Reset Logs**. When in need of assistance from tech support, use the **Debug Log** section to capture information useful for troubleshooting. Simply click **Start Debug Log**, wait at least one minute, and click **End Debug Log** to create the file. You can then download and send it to tech support.

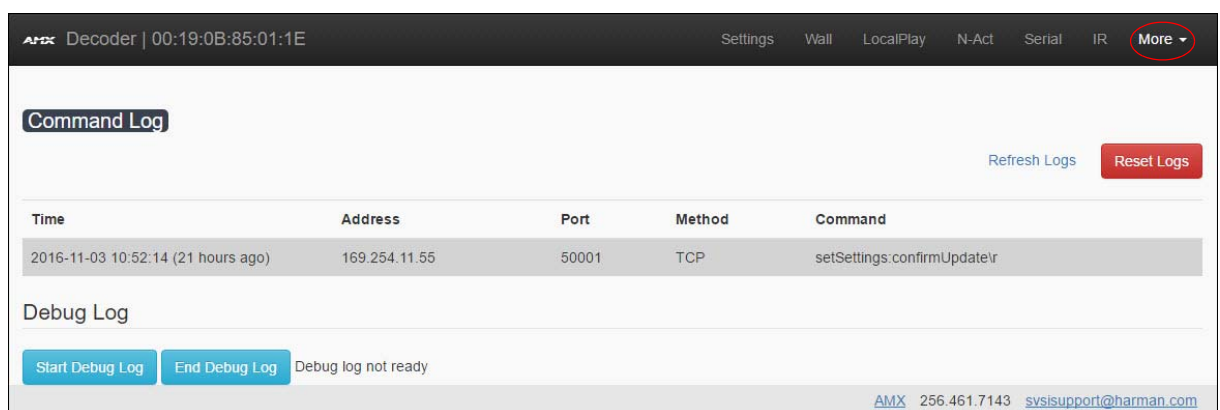

FIG. 47 Logs Page

Security Page

Click the **More** link at the top of any of the main web pages and select **Security** to access the page shown in [Figure 48](#). This page allows you to force HTTPS connections. To successfully communicate, the Decoder must know and match the Encoder password.

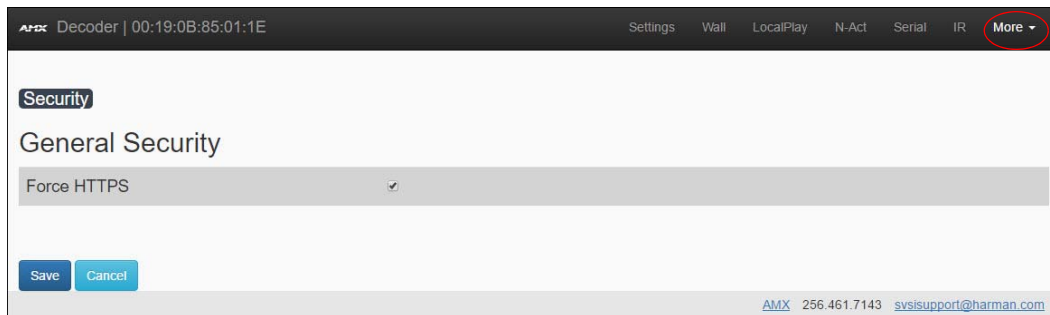

FIG. 48 Security Page

EDID Page

Click the **More** link at the top of any of the main web pages and select **EDID** to access the page shown in [Figure 49](#). Every display has stored information that it communicates to the output device. This page allows you to view the EDID information of the connected output display. Click the **Read** button to initially show the digital EDID information of the connected output display.

NOTE: *There are sometimes delays when launching this page. Allow plenty of time before clicking any other links.*

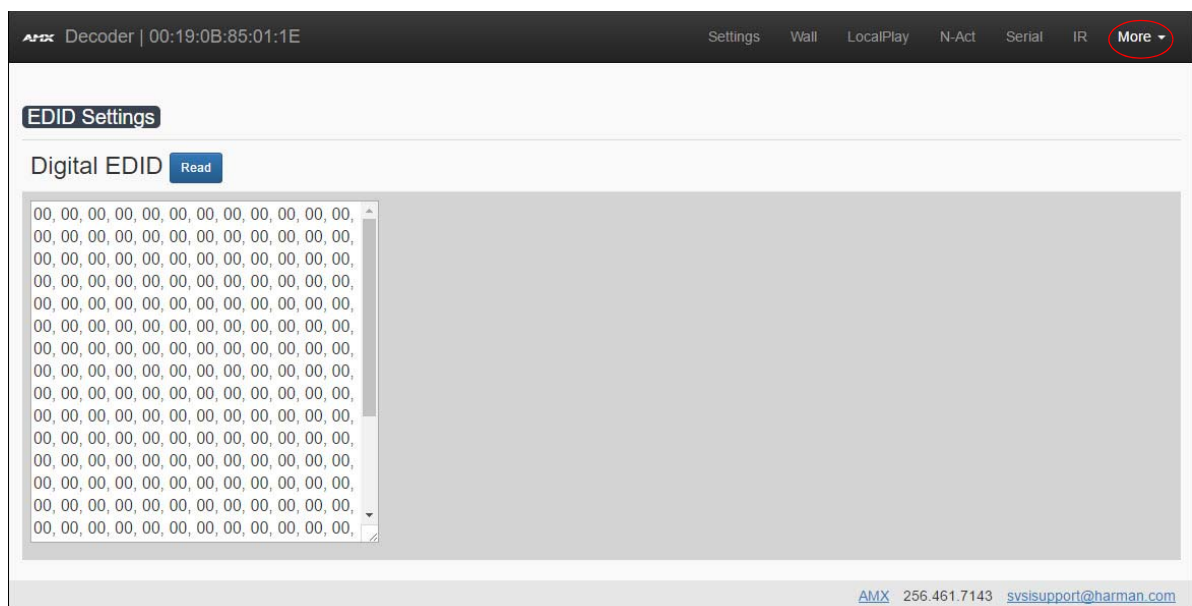

FIG. 49 EDID Page

LLDP Page

Click the **More** link at the top of any of the main web pages and select **LLDP** to access the page shown in [Figure 50](#). The **LLDP** page displays information from the Link Layer Discover Protocol (LLDP) packet which identifies the port number and switch the device is connected to.

FIG. 50 LLDP Page

NetLinx Page

Click the **More** link at the top of any of the main web pages and select **NetLinx** to access the page shown in [Figure 51](#). Options are described in [Table 26](#). This page allows you to prepare your N2322 Decoder for NetLinx-driven configuration. This is explained in more detail in [Appendix A: NetLinx Control](#), on page 59.

NOTE: *NetLinx takes over the Serial port when active.*

FIG. 51 NetLinx Page

TABLE 26 NetLinx Page Options

Command	Description
Enable	Click to enable/disable NetLinx on this device.
Device Status	This status field will show the device to be Online , Connected , Offline , or Unknown .
Master Mode	Select Auto , Listen , or URL .
IP/URL	Enter the address of the Master Controller.

TABLE 26 NetLinx Page Options (Cont.)

Command	Description
Port	This field should always be set to 1319 .
Device Number	Defaults to a dynamic device number. May be set to a static range (e.g., 8000).
System Number	Determines which system to connect. This setting is dependent upon the Master Mode selected (see above). <ul style="list-style-type: none"> • If Master Mode is set to Auto, the System Number is set and the system discovers the Master Controller's IP address. • If Master Mode is set to Listen, the device connects to any Master Controller. • If Master Mode is set to URL, the IP of the Master Controller is set.
Username	Username for the Master Controller.
Password	Password for the Master Controller.
Save button	Click to save settings made on this page.

Troubleshooting

This chapter contains possible solutions to some common issues. Should you encounter any problems not covered by these guidelines, please contact technical support via email (svsisupport@harman.com) or call 256.461.7143 x9900. You can also visit our support webpage at support.svsia.com.

Issues	Suggestions
LocalPlay screen displays instead of the stream from the Encoder.	<ul style="list-style-type: none"> • Verify Decoder is assigned to view a valid stream (of an active Encoder). • Verify that Encoder and Decoder are on the same subnet. • Verify Decoder is currently in Live play mode (its name will display in black text on the Video Matrix page). You can change to Live mode on the Settings page (see the Settings Page: Device Settings Section table on page 41 for more details). • Verify network is properly configured and set up. If needed, connect Encoder's network port to Decoder to bypass the network.
HostPlay screen displays instead of the video from the source.	<ul style="list-style-type: none"> • Verify Encoder is in Live play mode (its name will display in black text on the Video Matrix page). You can change to Live mode on the Settings page (see Settings Page: Device Settings Section table on page 25 for more details). • Verify source is attached and is outputting a valid signal (HDMI LED on Encoder is on).
Black screen/no screen displays.	<ul style="list-style-type: none"> • Set Decoder to LocalPlay. If the LocalPlay screen does not appear, check the display input settings and cabling. As mentioned previously in this table, you can change to the Local mode on the Decoder's Settings page. • If LocalPlay appears, set Decoder to Live play mode and verify network is configured properly. • If screen is black with a slight sparkle effect, verify that your switch has Jumbo Frame support enabled.
No audio is detected.	<ul style="list-style-type: none"> • If there is no audio on <u>all</u> Decoders, verify audio settings are correct on Encoder. • If there is no audio on a single Decoder, verify audio settings are correct on Decoder.
Device has been discovered in N-Able, but the configuration pages do not open when double-clicking device name on the Video Matrix page.	<ul style="list-style-type: none"> • Make sure your computer is in the same IP address range as the unit. See Setting Up Your Host Computer on page 12 for more information.
When changing the audio type, there are problems with audio in/out.	<ul style="list-style-type: none"> • Verify that the Encoder's Enable HDMI Audio setting is set to Auto. • Verify that Audio Mute is disabled (Encoder and Decoder).
Not receiving audio.	<ul style="list-style-type: none"> • Check that the Decoder has proper audio stream setting (typically by enabling Audio follows Video).
Not receiving analog video through the Encoder.	<ul style="list-style-type: none"> • On the Encoder, try setting the Video Source to VGA Only.
Serial port is not working as expected.	<ul style="list-style-type: none"> • Verify the RS232 Settings on the Settings page. • Connecting the Tx and Rx pins on the RS232 connector creates a loopback that could also help when troubleshooting. • If NetLinX is enabled, it will take the serial port over.

Series Default Local/Host Play Troubleshooting Screens

This section shows and defines the status screens displayed by N2300 Series devices.



FIG. 52 Host Play Screen

Displayed when Decoder...	...and Encoder...	Notes
<ul style="list-style-type: none"> is set to view an Encoder stream on the network 	<ul style="list-style-type: none"> is set to HostPlay, or does NOT have a valid input video signal 	Seeing this screen means that the Decoder CAN communicate with the Encoder across the network. It is a good way to troubleshoot network communication between segments using only Encoders and Decoders (without the need for source video into an Encoder).

NOTE: If you see can see the HostPlay screen but cannot see live video, this could mean that the Encoder and Decoder are not on the same subnet.



FIG. 53 Local Play Screen

Displayed when Decoder...	Notes
<ul style="list-style-type: none"> is set to LocalPlay mode 	If the Decoder is NOT set to Local Play mode, this screen could signify a network communication issue.



FIG. 54 Restricted Content Not Supported Screen

Displayed when Decoder...	...and Encoder...	Notes
<ul style="list-style-type: none"> • is receiving a stream from an Encoder • is connected to a monitor that does NOT support Restricted Content (i.e., the monitor is NOT HDCP compliant) 	<ul style="list-style-type: none"> • is transmitting HDCP-protected content to the Decoder 	<p>Once the Decoder detects that the monitor is not HDCP compliant, this screen is displayed. If you suspect that this message was displayed in error, please call Technical Support.</p>

NOTE: The version of HDCP protection of the source and the monitor must be compatible in order for the content to display successfully. For example, you can have an HDCP 1.4 compliant monitor and still see the screen in [Figure 54](#) if your source is HDCP 2.2.

Appendix A: NetLinx Control

Introduction

NetLinx Studio is commonly used by system programmers to streamline the integration, programming, organization, and support of their AMX equipment. As the cornerstone of AMX's system design software tools, NetLinx Studio offers programmers the most flexible application capable of generating the most sophisticated code possible. Now equipment in our latest N-Series Networked AV Product comes equipped with NetLinx support. This addendum introduces the new configuration aspects necessary to bring all of your NetLinx-compatible equipment up to speed with the latest functionality. This addendum covers NetLinx functionality as it applies to AMX's N-Series product line - specifically the N-Series Encoders/Decoders - and is designed to be used as a supplement to additional product documentation found on our website at <http://www.amx.com/techcenter/manuals.asp>.

Common Applications

NetLinx Studio is a Microsoft Windows program that integrates programming, organization, and support into one application for NetLinx system development.

NetLinx Configuration Using the Unit's Webpage

From any main page of the unit webpage, click the **NetLinx** tab. See [Figure 55](#). [Table 27](#) provides descriptions for each configuration option.

Click **More** and choose **NetLinx** to access these configuration options.

Configuration options available will depend on which **Master Mode** you choose. See [Table 27](#) for more details.

FIG. 55 NetLinx Configuration Page

TABLE 27 NetLinx Configuration Options

Command	Description
Enable	Click to enable/disable NetLinx on this device.
Device Status	This status field will show the device to be Online , Connected , Offline , or Unknown .
Master Mode	Select Auto , Listen , or URL .
IP/URL	Enter the address of the Master Controller.
Port	This field should always be set to 1319 .
Device Number	Defaults to a dynamic device number. May be set to a static range (e.g., 8000).

TABLE 27 NetLinx Configuration Options (Cont.)

Command	Description
System Number	Determines which system to connect. This setting is dependent upon the Master Mode selected (see above). <ul style="list-style-type: none"> If Master Mode is set to Auto, the System Number is set and the system discovers the Master Controller's IP address. If Master Mode is set to Listen, the device connects to any Master Controller. If Master Mode is set to URL, the IP of the Master Controller is set.
Username	Username for the Master Controller.
Password	Password for the Master Controller.
Save	Save settings made on this page.

Batch Configurations Using N-Able

One of the many benefits of using N-Able control is batch configuration. This is especially useful in larger deployments. Instead of using the individual unit web pages (discussed in the previous section), simply open N-Able and select **Tools > Batch Config**. See [Figure 56](#).

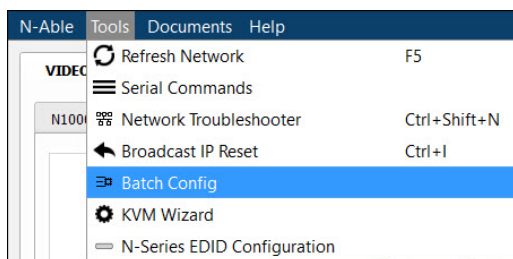

FIG. 56 Selecting Batch Config in N-Able

The screen shown in [Figure 57](#) displays and allows you to choose the units you would like to enable for NetLinx control. To select multiple units, hold down the **<Ctrl>** key. Once all of the units are selected, enable the **NetLinx On** button and click the **OK** button at the bottom of the screen.

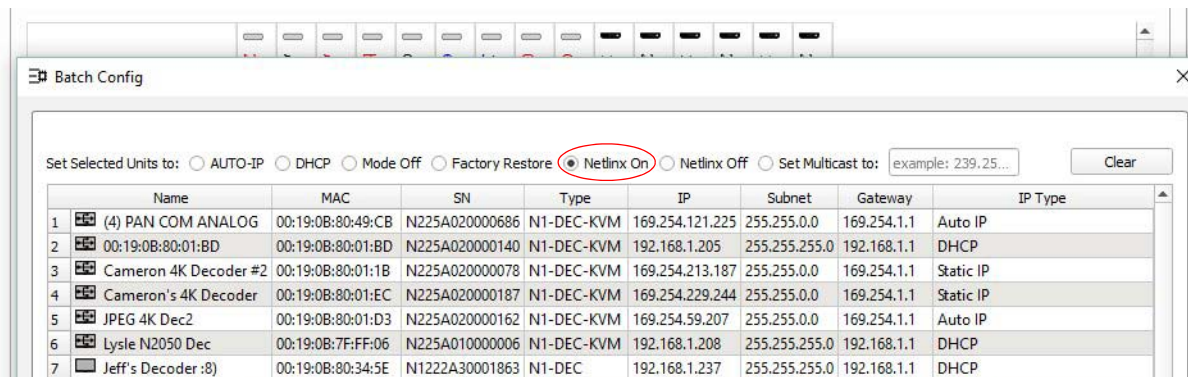

FIG. 57 Enabling NetLinx on Multiple Units

NOTE: Items are not filtered. In other words, if you send a NetLinx command to a device that does not support it, the command is simply ignored.

Encoder/Decoder Commands

The following section provides information on native, string, IR, and serial commands for N-Series Encoders and Decoders as related to NetLinx management. Commands are issued on the following ports:

- Port 1: Native and String Commands
- Port 2: IR Commands
- Port 3: Serial Commands

Native Commands Port 1

Command	Description
CO <stream> Set the current Encoder stream number.	IMPORTANT: <i>This command must be sent to D:P:S port 1.</i> Syntax: SEND_COMMAND <DEV>, 'CO <stream>' Variables: stream = The target stream number from 1 to 32767. NOTE: <i>Stream number MOD 256 must not equal 0 or 255.</i> Examples: SEND_COMMAND 5002:1:0, 'CO 2' Command the Encoder to transmit on stream 2.
CI <stream> Set the current Decoder stream number.	IMPORTANT: <i>This command must be sent to D:P:S port 1.</i> Syntax: SEND_COMMAND <DEV>, 'CI <stream>' Variables: stream = The target stream number from 0 to 32767. NOTE: <i>Stream number MOD 256 must not equal 0 or 255. The only exception to this limitation is that the stream number can be 0 (no stream).</i> Examples: SEND_COMMAND 5002:1:0, 'CI 2' Command the Decoder to receive stream 2.
CA <stream> Set the current Decoder Audio stream number.	IMPORTANT: <i>This command must be sent to D:P:S port 1.</i> Syntax: SEND_COMMAND <DEV>, 'CA <stream>' Variables: stream = The target stream number from 0 to 32767. Set to 0 for the audio stream to follow the video stream. Examples: SEND_COMMAND 5002:1:0, 'CA 2' Command the Decoder to receive audio stream 2.
AUDOUT_MUTE Set the audio mute.	IMPORTANT: <i>This command must be sent to D:P:S port 1.</i> Syntax: SEND_COMMAND <DEV>, 'AUDOUT_MUTE-<ENABLE DISABLE>' Variables: ENABLE = Enables audio mute. DISABLE = Disables audio mute. Examples: SEND_COMMAND 5002:1:0, 'AUDOUT_MUTE-ENABLE' Enable audio mute.
VIDOUT_MUTE Disable the Encoder/Decoder output stream.	IMPORTANT: <i>This command must be sent to D:P:S port 1.</i> Syntax: SEND_COMMAND <DEV>, 'VIDOUT_MUTE-<ENABLE DISABLE>' Variables: ENABLE = Enables video mute. DISABLE = Disables video mute. Examples: SEND_COMMAND 5002:1:0, 'VIDOUT_MUTE-ENABLE' Enable video mute.
LIVE_PLAY Set the device into live play mode.	IMPORTANT: <i>This command must be sent to D:P:S port 1.</i> Syntax: SEND_COMMAND <DEV>, 'LIVE_PLAY' Examples: SEND_COMMAND 5002:1:0, 'LIVE_PLAY' Enable live play.

Native Commands Port 1 (Cont.)

Command	Description
LOCAL_PLAY <Playlist index> Enable Local Play on Decoders or Host Play on Encoders using the Playlist number.	IMPORTANT: <i>This command must be sent to D:P:S port 1.</i> Syntax: SEND_COMMAND <DEV>, 'LOCAL_PLAY index' Variables: Playlist index = Which Default Playlist index to enable. Examples: SEND_COMMAND 5002:1:0, 'LOCAL_PLAY 1' Enable local play with Default Playlist 1.
USB_HID_SERVICE Enable or disable USB.	IMPORTANT: <i>This command must be sent to D:P:S port 1.</i> Syntax: SEND_COMMAND <DEV>, 'USB_HID_SERVICE-<ENABLE DISABLE>' Variables: ENABLE = Enables USB. DISABLE = Disables USB. Examples: SEND_COMMAND 5002:1:0, 'USB_HID_SERVICE-ENABLE' Enable USB.
REBOOT Reboot the device.	Syntax: SEND_COMMAND <DEV>, 'REBOOT' Variables: None Examples: SEND_COMMAND 5002:1:0, 'REBOOT' Reboots the device.
?VIDOUT_OUTPUT Request the Encoder current stream number.	Syntax: SEND_COMMAND <DEV>, '?VIDOUT_OUTPUT' Examples: SEND_COMMAND 5002:1:0, '?VIDOUT_OUTPUT' Command Response: 'VIDOUT_OUTPUT-852'
?VIDIN_INPUT Request the Decoder current stream number.	Syntax: SEND_COMMAND <DEV>, '?VIDIN_INPUT' Examples: SEND_COMMAND 5002:1:0, '?VIDIN_INPUT' Command Response: 'VIDIN_INPUT-852'
?AUDOUT_MUTE Request the state of the audio mute.	Syntax: SEND_COMMAND <DEV>, '?AUDOUT_MUTE' Examples: SEND_COMMAND 5002:1:0, '?AUDOUT_MUTE' Command Response: 'AUDOUT_MUTE-ENABLE'
?VIDOUT_MUTE Request the state of the Encoder stream transmission.	Syntax: SEND_COMMAND <DEV>, '?VIDOUT_MUTE' Examples: SEND_COMMAND 5002:1:0, '?VIDOUT_MUTE' Command Response: 'VIDOUT_MUTE-DISABLE'
?LIVE_PLAY Request the status of Live Play.	Syntax: SEND_COMMAND <DEV>, '?LIVE_PLAY' Examples: SEND_COMMAND 5002:1:0, '?LIVE_PLAY' Command Response: 'LIVE_PLAY-live' or 'LIVE_PLAY-local'

Native Commands Port 1 (Cont.)

Command	Description
?LOCAL_PLAY Request the Local Play/Host Play Playlist number.	Syntax: SEND_COMMAND <DEV>, '?LOCAL_PLAY' Examples: SEND_COMMAND 5002:1:0, '?LOCAL_PLAY' Command Response: 'LOCAL_PLAY-1'
?USB_HID_SERVICE Request the status of the USB.	Syntax: SEND_COMMAND <DEV>, '?USB_HID_SERVICE' Examples: SEND_COMMAND 5002:1:0, '?USB_HID_SERVICE' Command Response: 'USB_HID_SERVICE-<0 1>'

IR/Serial Send Commands Port 3

Command	Description
GET BAUD Get the RS-232 port's communication parameters.	Syntax: SEND_COMMAND <DEV>, 'GET BAUD' Example: SEND_COMMAND 5002:3:0, 'GET BAUD' Command Response: 'GET-9600,N,8,1'
SET BAUD Set the RS-232 port's communication parameters.	Syntax: SEND_COMMAND <DEV>, 'SET BAUD <baud>,<parity>,<data>,<stop>' Variables: baud = baud rates are: 115200, 57600, 38400, 19200, 9600, 4800, 2400, 1200. parity = N (none), O (odd), E (even). data = 8 data bits. stop = 1 and 2 stop bits. Example: SEND_COMMAND 5002:3:0, 'SET BAUD 9600,N,8,1' Command Response: 'SET- BAUD 9600,N,8,1'

Pass Through Commands

For other commands, the NetLinx String command will interpret any existing N-Series API command. For example, to enable the scaler, send the following string command:

```
SEND_STRING <DEV>, 'scalerenable'
```

Similarly, to disable the scaler, send the string command:

```
SEND_STRING <DEV>, 'scalerdisable'
```

The response to a pass through string command is the issued command followed by the status message. For example:

- Command string:

```
SEND_STRING <DEV>, 'scalerenable'
```

- Response string

```
"scalerenable-SVSI_RXGEN2:N225A020000140',A,'NAME:00:19:0B:80:01:BD',A,'MAC:00:19:0B:80:01:BD'..."
```

NOTE: Multiple commands cannot be issued together separated by '\r'.

For more information, refer to the API documentation for the N-Series device.

IR Port 2

Using the NetLinx Studio application, download the appropriate IR file to the N-Series device to use the appropriate channels. Port 2 is used to send IR commands. Some tuning of the NetLinx **Pulse Time**, **IR Command Holdoff**, and **IR Repeat Holdoff** on the N-Series device may be required. The Pulse Time is controlled in the SNAPY code. The **IR Command Holdoff** and the **IR Repeat Holdoff** are controlled on the **Advanced** section of the N-Series device **Settings** web page. See [Figure 58](#) to see where to find these options.

IR Command Holdoff

- This is the delay between IR commands portions.
- To set the IR Command Holdoff, issue the following string command:
SEND_STRING <DEV>, 'setSettings:ircmdtime:<time in ms>'
- The default value is 25 ms.

IR Repeat Holdoff

- This is the repeat delay between IR commands.
- To set the IR Repeat Holdoff, issue the following string command:
SEND_STRING <DEV>, 'setSettings:irc2rtime:<time in ms>'
- The default value is 90 ms.

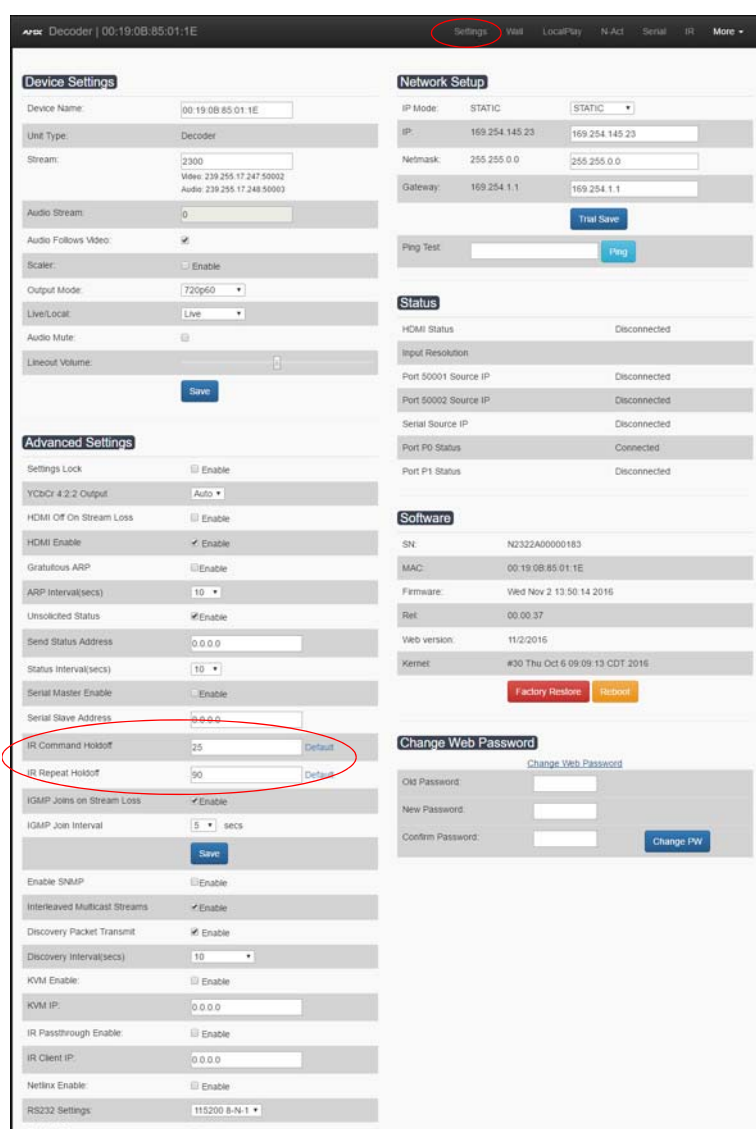

FIGURE 58 Advanced IR Port Settings

Serial Port 3

Port 3 is used for serial commands. Any string sent with the send string command will be output through the serial port. Data returned from the serial port will be from the device also on port 3.

Appendix B: Minimum Network Requirements

The following list specifies the minimum network requirements that must be considered when deploying your N-Series equipment. These requirements cover the necessary protocols and features needed to drive N-Series streams.

NOTE: *Specific configuration recommendations are based off of the Cisco Catalyst series, however this may vary.*

1. **Managed Network Switch**
2. **Gigabit Ethernet (N1000/2000 Based Systems)**
3. **Internet Group Management Protocol (IGMP) Version 2**
 - IGMP Snooping
 - IGMP Snooping Querying
 - Network must include at least one IGMP Querier to maintain stream connections. It is recommended to have all capable switches with the querier enabled and allow IGMP auto-elect to determine the Designated Querier (DQ).
 - Query Interval – 30 seconds. This is the interval between sending IGMP general queries.
 - Query Response Interval – 10 seconds. This is the maximum time the system waits for a response to general queries.
 - Last Member Query Interval – 100 milliseconds. This is the interval to wait for a response to a group specific or group-and-source-specific query message.
 - Immediate Leave (also known as Fast Leave, etc. depending on switch manufacturer).
 - Immediate Leave breaks any daisy chaining of multiple units together with a single home run, therefore you will not be able to have both Immediate Leave units and daisy chaining on the same VLAN.

NOTE: *If Immediate Leave is disabled, set IGMP Robustness to Default 2. Robustness can be adjusted generally from 2-10. The higher the value, the more leave latency is added.*

- Warnings/Notices
 - There is a known behavior within IGMP that Encoder streams, whether requested across an uplink or not, will be requested by the DQ and will be present on all uplinks between the stream source switch and the DQ.
 - This means that even though you may not be routing a stream to another switch, the DQ's request still puts the stream on the uplink. Therefore, it is important to account for all streams forwarding to the DQ.
 - The presence of a multicast router with PIM-Sparse configured to handle the multicast traffic may eliminate or limit this behavior.
 - N-Series Encoders also support separate VLAN tagging of audio and video streams to allow only certain audio and video streams through an uplink in order to eliminate or limit this behavior.
4. **Jumbo Frames Enabled**

The N2300 Series Encoders/Decoders produce a frame payload larger than 1500 bytes which requires the switch to have the capacity of handling Jumbo Frames enabled.
 5. **TCN Flood Off**

TCN flood protocol will cause unnecessary backplane and bandwidth usage when adding or removing a device on the network. This can cause stream interruptions as the flooding sweeps through the network.

Should you encounter any problems not covered by these guidelines, please contact technical support via email (svsisupport@harman.com) or call 256.461.7143 x9900.



© 2016 Harman. All rights reserved. AMX, AV FOR AN IT WORLD, and HARMAN, and their respective logos are registered trademarks of HARMAN. Oracle, Java and any other company or brand name referenced may be trademarks/registered trademarks of their respective companies. AMX does not assume responsibility for errors or omissions. AMX also reserves the right to alter specifications without prior notice at any time. The AMX Warranty and Return Policy and related documents can be viewed/downloaded at www.amx.com.
3000 RESEARCH DRIVE, RICHARDSON, TX 75082 AMX.com | 800.222.0193 | 469.624.8000 | +1.469.624.7400 | fax 469.624.7153
AMX (UK) LTD, AMX by HARMAN - Unit C, Auster Road, Clifton Moor, York, YO30 4GD United Kingdom • +44 1904-343-100 • www.amx.com/eu/

Last Revised:
12/2016
850DOCN2300MNREV1.0