

JVC

HD Memory Card Camera Recorder

GY-HC900

CONNECTED CAM™



The Ultimate Live-Over-IP

Product photo shown with optional equipment.



CONNECTED CAM™

The first model of JVC's CONNECTED CAM series, the GY-HC900 is a unique and innovative broadcast camcorder that makes no compromises in image quality while offering a level of connectivity not found elsewhere. It features three 2/3-inch CMOS image sensors that deliver high sensitivity, low noise and wide dynamic range, as well as IPX2 equivalent robust body for challenging scenes. It's equipped with a new powerful communications engine that truly makes News-over-IP a reality with a streamlined ENG workflow that's both reliable and cost-effective. The CONNECTED CAM expands complete IP-based solution, connecting the field with the studio.



Superb Camera Performance

2/3-inch 3CMOS Sensors with High Sensitivity of F12 (60Hz)/F13 (50Hz)

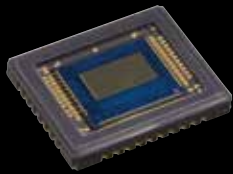

The GY-HC900 is equipped with three 2/3-inch 2.2 megapixel CMOS sensors, combined with an F1.4 prism to deliver full HD 1920 x 1080 images with excellent

sensitivity of F12 at 60Hz/F13 at 50Hz, a remarkable signal-to-noise ratio of 62dB, and a wide dynamic range.

New Image Processing Engine

JVC's first camera featuring a new communications engine that optimizes both image processing and IP performance. The engine enables both recording and low latency streaming, as well as simultaneous decoding for return video and IFB.

50Mbps 4:2:2 10-bit Recording (H.264) and Standard MPEG-2 (35Mbps) Recording

The GY-HC900 is equipped with the H.264 Extreme-High Quality (XHQ) 50Mbps (MOV) 4:2:2 10-bit recording mode for virtually no block noise even when recording rapid action sequences. Also supported is MPEG-2 Long GOP recording up to 35Mbps; a widely used format by television broadcasters. With a variety of recording formats, the GY-HC900 provides professionals with unprecedented flexibility to meet production standards through a wide range of workflows.

Industry-Standard B4 Lens Mount



With an industry-standard B4 lens mount, you can install a wide selection of existing B4 ENG lenses for a variety of shooting applications while saving cost.

Professional OLED Viewfinder



A professional 3.26" OLED viewfinder offering excellent visibility comes equipped as standard, making focusing is easy. Also present is a 3.5" LCD panel for menu navigation.

HDR via HLG/J-Log 1

The GY-HC900 is equipped with the HDR compatible HLG (Hybrid Log Gamma) mode and JVC's proprietary J-Log 1 Gamma mode. These enable high dynamic range capture of a broad spectrum with 10-bit recording for better color grading and to avoid banding.

HLG & J-Log 1 Color Gamut

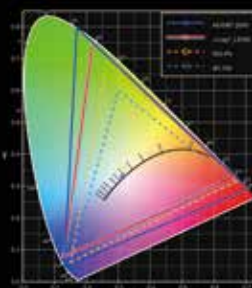

Footage recorded in HLG mode will deliver a full HDR image when viewed on HLG-compatible monitors. The J-Log 1 mode delivers wide latitude and a high dynamic range of 800%.

J-Log 1 and Rec709+Knee Gamma

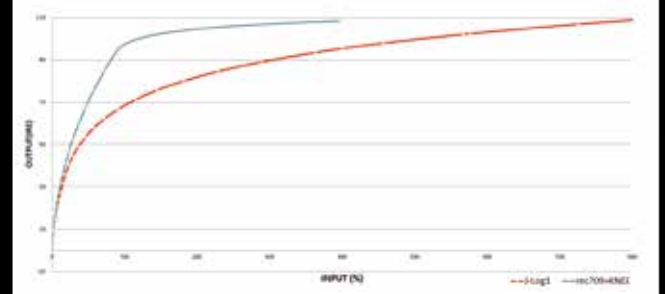

Various Codecs and File Formats

	Mode (Bit rate)	Resolution	File format
MPEG-4 AVC/H.264	XHQ (50Mbps 4:2:2 10-bit)	1920 x 1080	MOV
		1280 x 720	
	XHQ (50Mbps)	1920 x 1080	
	UHQ (35Mbps)	1920 x 1080	
		1280 x 720	
	HQ (8Mbps)	720 x 480 (U model) 720 x 576 (E model)	
	Web HQ (3Mbps)	960 x 540	
Web LP (1.2Mbps)	480 x 270		
MPEG-2 Long GOP	HQ (35Mbps)	1920 x 1080	MOV/MXF
		1440 x 1080	
		1280 x 720	
	SP (25Mbps)	1440 x 1080	

High-Speed Rec

MPEG-4 AVC/H.264	XHQ (50Mbps)	1920 x 1080	MOV
	UHQ (35Mbps)		

Magnesium Alloy Body and IPX2 Equivalent Splash-Proof

Its robust body makes the GY-HC900 ready to work in harsh environments and situations. IPX2 equivalent splash-proof standard compliance enables image gathering in the field with confidence.



Connected to the Field. Delivering to the World.

ENG STUDIO



Product photo shown with optional equipment.

- Live-over-IP Features

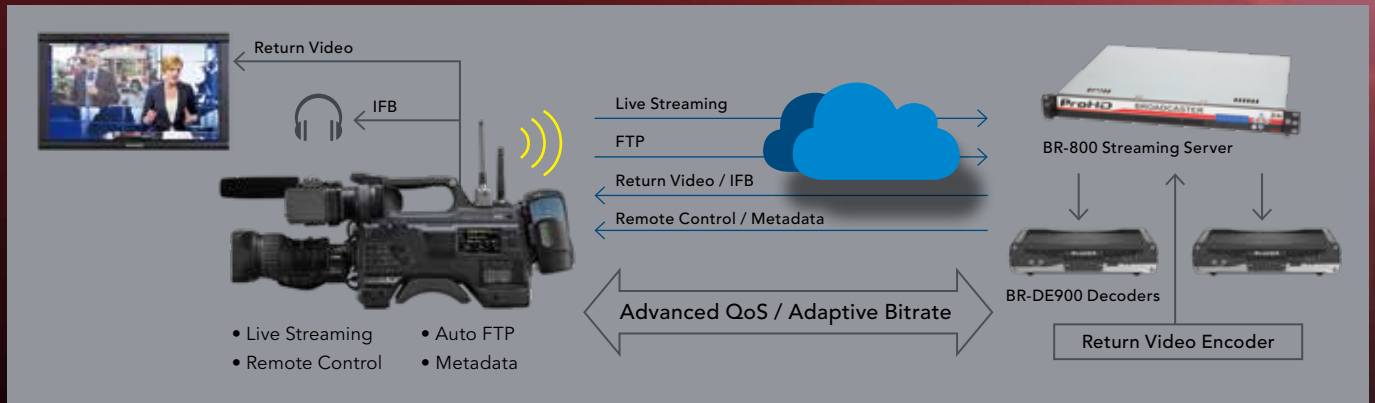

As the first in the CONNECTED CAM series, the GY-HC900 is a professional camcorder that delivers a variety of features and performance required in the field with IP

connectivity. Count on camera-to-studio and studio-to-camera two-way data communication to enable you to build an advanced Live-over-IP workflow solution.

- Live Streaming up to 20Mbps with Low Latency

The GY-HC900 is capable of streaming LIVE HD/SD and proxy video/audio files via network up to 20Mbps with low latency. High quality, stable streaming is possible from the field using just the camera itself*. No need to carry a heavy backpack or external boxes.

*With an appropriate network connection

- Return over IP for ENG

The GY-HC900 can receive return video/IFB from the station while streaming live to air via IP thanks to a new platform. This allows reporters and camera operators to wirelessly receive directions from the station.

- Auto FTP

It's possible to upload video clips to an FTP server via IP. Auto upload function allows you to upload the recorded clip in background.

- Connection in the Field

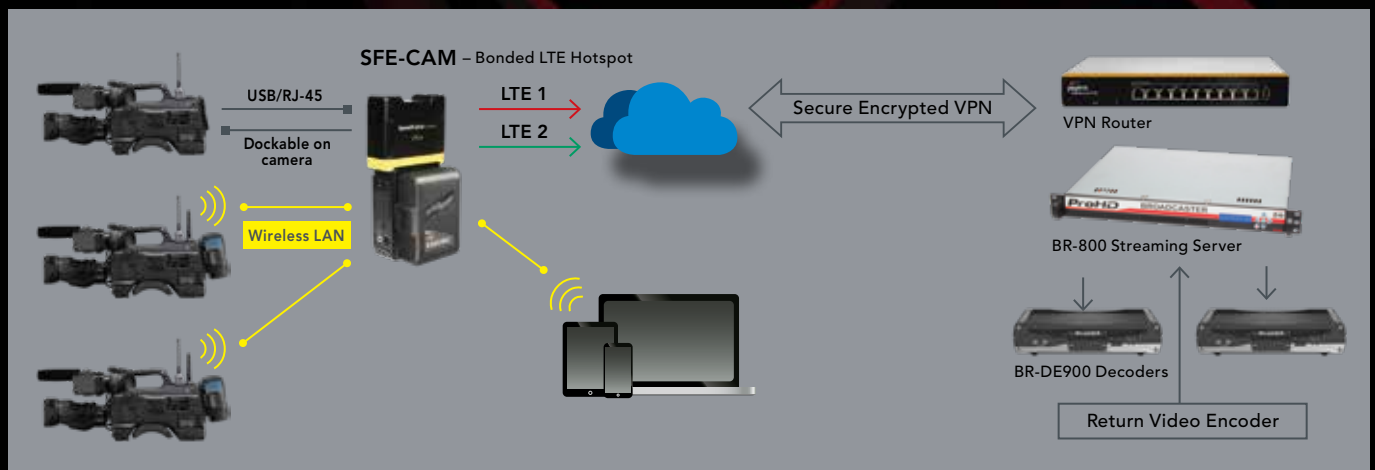

SFE-CAM is a powerful bonded cellular hotspot that docks directly to the GY-HC900 camcorder and features Peplink's patented SpeedFusion™ technology. Multiple GY-HC900 units can be connected to SFE-CAM via built-in Wireless LAN with dual external antennas. SFE-CAM bonds multiple cellular and Wireless LAN connections enabling the user to send digital video at greater speeds than you could with a single modem, and at a fraction of what it would

cost using a conventional satellite connection. And even while docked to a single camera, this unit provides the power and connectivity that lets you stream from multiple cameras to HD-SDI decoders or servers at a central location. It's provided with dual cellular modems with redundant SIM slots and dual band Wireless LAN letting you use up to four different providers for bandwidth bonding, data overage protection or eliminating blind spots.

- Hosting BR-800 in the Cloud for Live Feeds and Playout Sharing

JVC's lens-to-playout connectivity continues through the BR-800 ProHD Broadcaster, powered by Zixi. Through its web interface, it enables video feeds from various locations can be delivered to multiple decoders. Several TV stations can share content and live feeds via central video server.

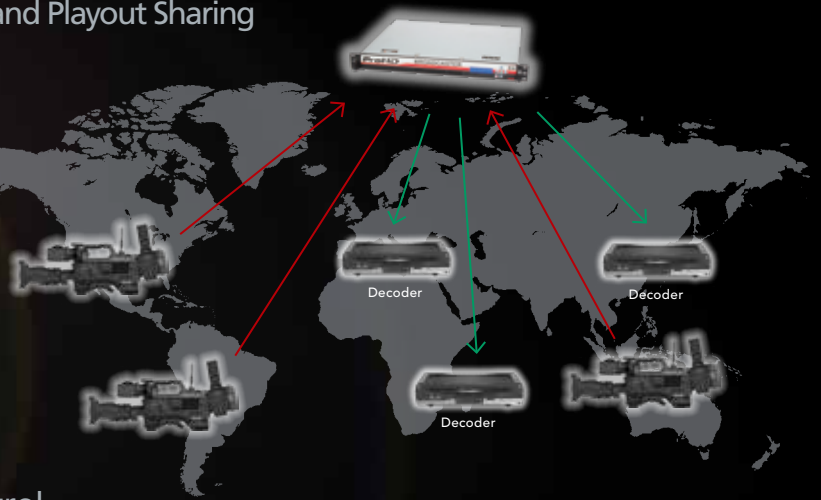

- GPS — Asset Tracking and Remote Control

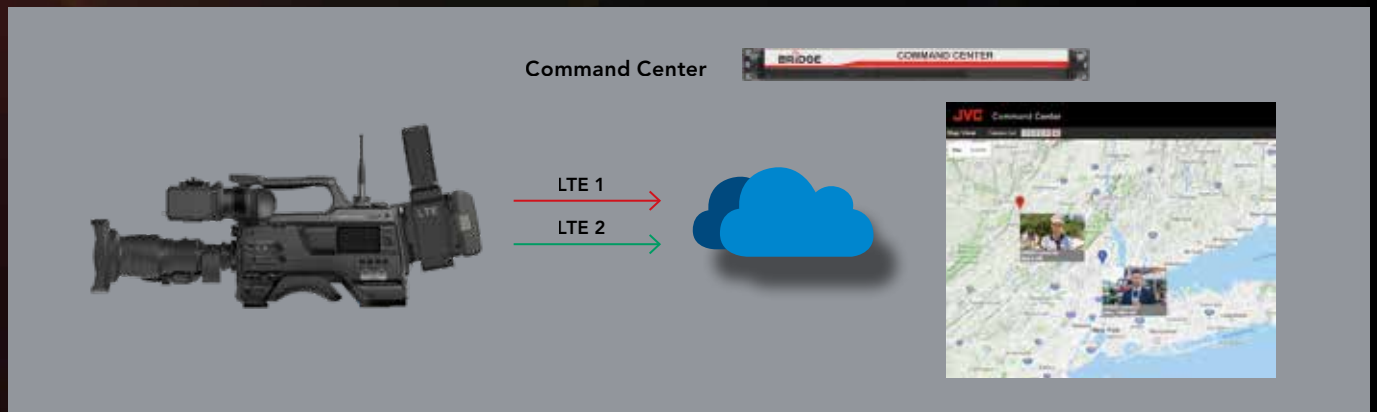

Monitor and track all of your JVC IP assets in real-time, with this unique server-based package. The JVC Command Center provides a full screen map of all GPS enabled resources – even live video feeds – with instantly clickable camera control, stream data, error correction status and much more. For TV stations, a single glance

will tell you the whereabouts of your field crews at any time of the day. You can even log the locations of specific assets so that you can track where they've been. There's never been a tool that provides this much information and control over all of your IP assets.

- Fiber Remote Studio System

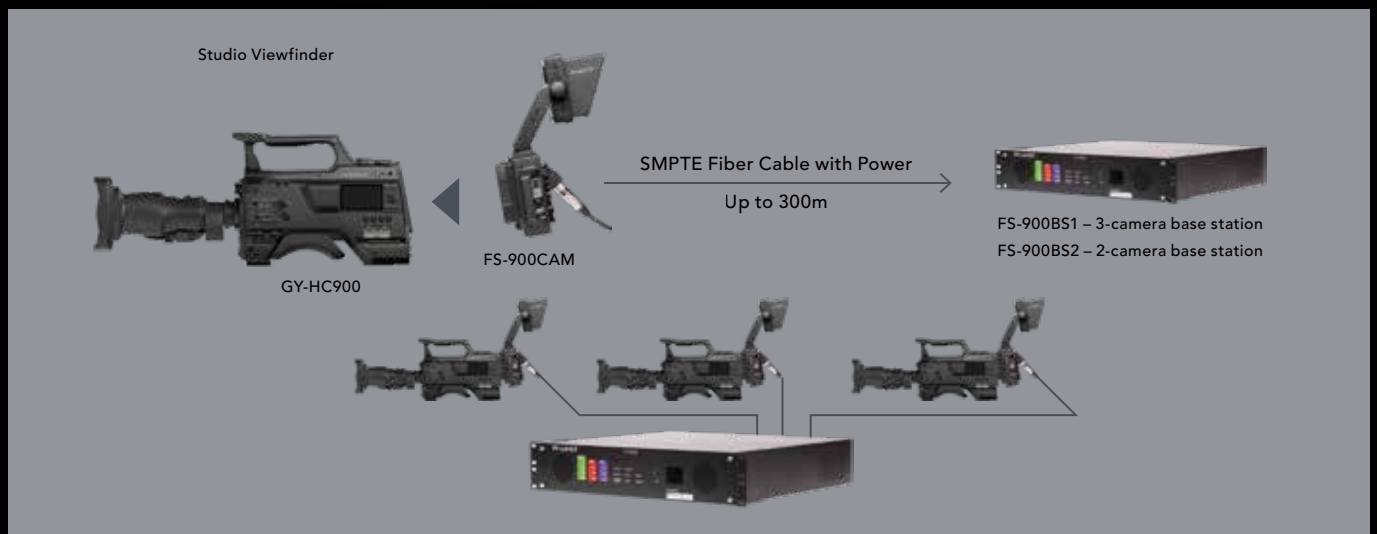

The GY-HC900 is an ideal choice for high-end EFP and studio fiber applications. It works with the FS-900 camera module, which attaches seamlessly to the back of the

GY-HC900 via a 68-pin interface, and feeds 3G-SDI signals, control, audio, sync, and intercom to a base station via fiber.



Connected to Excitement. Share it with the World.

LIVE EVENT PRODUCTION

Product photo shown with optional equipment.

- Complete Video-over-IP Solution for Remote Production

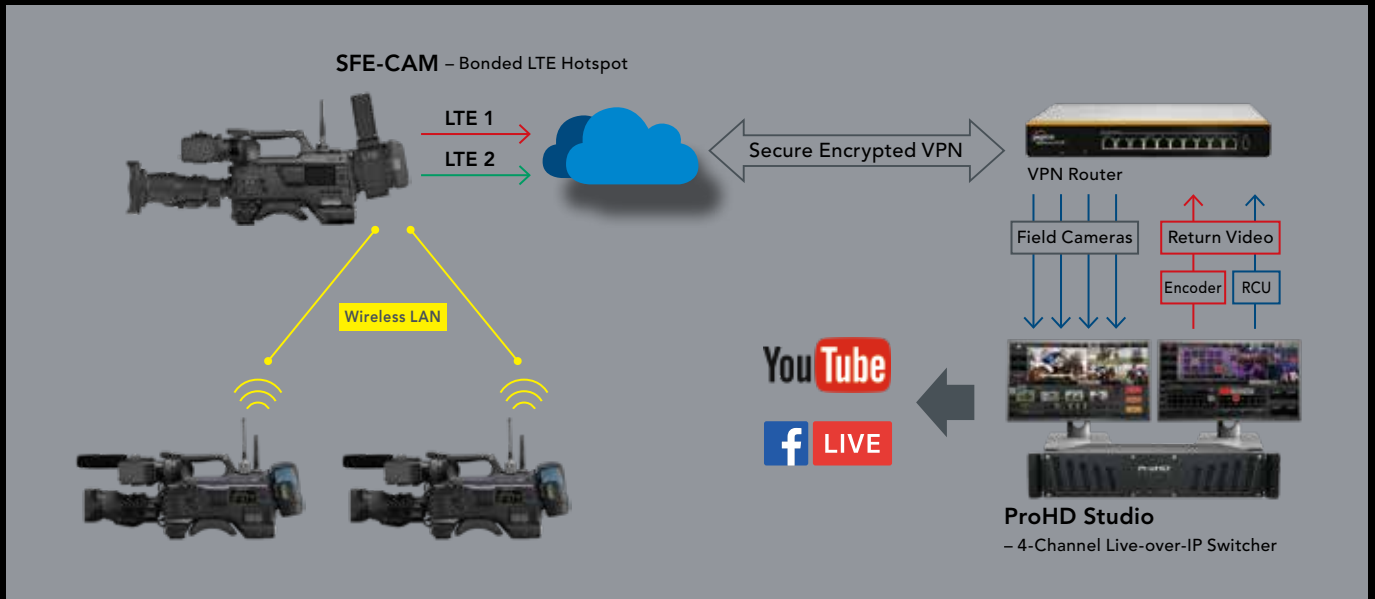

The GY-HC900 with ProHD Studio system provides an affordable multi-camera live production solution with unique features in this class. It's the ideal integrated production switcher for a variety of markets, from smallmarket news and sports broadcasts to live concerts and worship services.

The ProHD Studio accepts four Video-over-IP streams from the GY-HC900 (or JVC IP-supported cameras). And a built-in H.264 encoder supports up to 1080p streaming at up to 20 Mbps, with RTMP and MPEG-TS simultaneous

output and direct streaming integration to Facebook Live and other CDNs. Output choices include dedicated HD-SDI and HDMI ports, plus an HDMI display port for multi-view or program monitoring.

IP accommodates streaming from the camera as well as RCU and return, IFB from the studio, including tally and voice instructions. This system is suitable for compact live production and streaming studio for live events such as concerts, sports, ceremonies and conferences.

- Streaming Peer-to-Peer to Decoder or CDNs

The GY-HC900 supports various live streaming protocols to accommodate a range of usages.



UDP/RTP: Streaming to BR-DE900 or other decoder. For more reliable streaming supporting RTP/ SMPTE 2022-1 with Forward Error Correction (FEC).

RTMP: Direct streaming to YouTube, Facebook Live or other CDNs.

Zixi: Streaming to Zixi, ProHD Broadcaster or Broadcaster on Cloud. Advanced QoS technology for reliable communication with Forward Error Correction (FEC), Auto Repeat Request (ARQ), and adaptive bit rate control.

■ High-Speed Recording for 1080p Slow Motion Playback

High-speed recording (1920x1080) at up to 120fps (59.94Hz)/100fps (50Hz) is available for smooth slow motion playback (up to 1/5 slow at 24p mode). An essential feature for smooth slow motion viewing of sports and live events.

■ 16-Axis Color Matrix Adjustment

The GY-HC900 offers wide-range 16-Axis Color Matrix adjustability. This enables fine adjustment over a wide spectrum including subtle skin tones while recording and relaying video using multiple cameras.

■ INTEROP and Sports Exchange Format Support

Thanks to INTEROP and Sports Exchange Standard format support (in US market only), sports organizations can produce HD video with rich metadata that specifically addresses the workflow needs of sports production and video coaching applications.

■ 3G-SDI Pool Feed Input

An integrated 3G-SDI pool feed input allows the GY-HC900 operator to capture video and stream it live simultaneously.

■ Other features • Pre-Rec • Dual Rec

Usability and Connectivity

Equipped with a variety of interfaces, the GY-HC900 offers versatility while meeting the needs of professional applications.

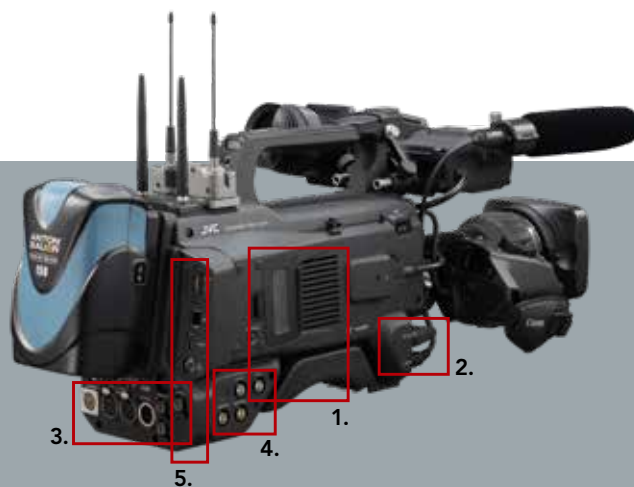

1. • SDHC/SDXC Card Slots • Card Slot Selector

Dual slots enable series recording, dual recording, and backup recording using two cards.



2. • Mic In

XLR 5-pin for stereo audio input.



3. • XLR Audio In (x2) • XLR Audio Out • SDI Out (x2) • SDI In • DC Out (12V) • DC In • Phone • Remote

SDI input with 3G-SDI pool feed capability for simultaneous recording and live streaming. Two XLR audio inputs are switchable between microphone (with phantom power support) and line input, plus stereo AUX inputs.



4. • TC Out • TC In • Video Out • Genlock

Equipped with genlock input and timecode in/out terminals, the GY-HC900 can be easily integrated into multi-camera setups.



5. • USB Host (USB3.0) • LAN (RJ-45) • HDMI • DC Out (12V)

Various IP connections available via RJ-45 (Wired LAN) and Host USB (3.0). DC out for power supply to peripheral equipment.

System Configuration

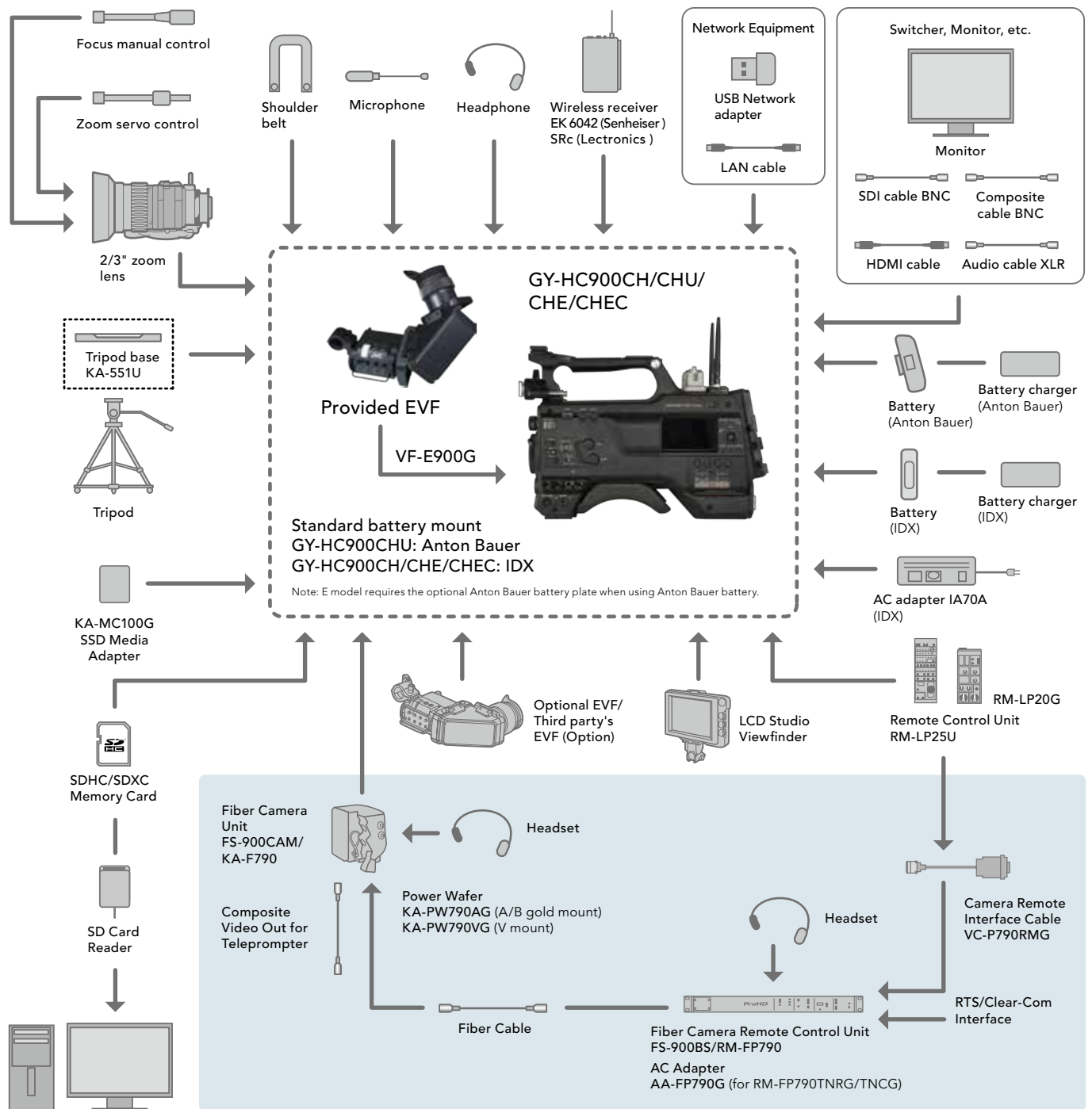





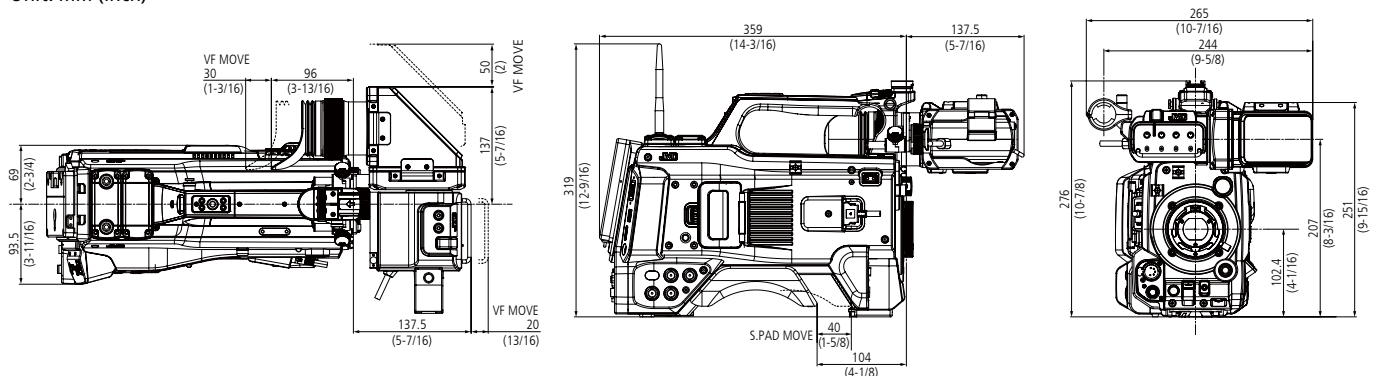













Dimensions

Unit: mm (inch)



Options

 <p>KJ20x8.2BKRSD (Canon) 2/3" Zoom Lens</p>	 <p>HZ-AS1 Manual Zoom Control</p>	 <p>HZ-FR15G Manual Focus Control</p>
 <p>RM-LP25U Remote Control Unit</p>	 <p>RM-LP20G Remote Control Unit</p>	 <p>RM-LP100 Remote Camera Controller via LAN</p>
 <p>KA-551U Tripod Base V-mount Adapter</p>	 <p>Dionic XT Anton Bauer Battery</p>	 <p>DUO-C98 IDX Battery</p>
 <p>SMX-100 Azden Stereo Shotgun Mic</p>	 <p>Tandem 70 Anton Bauer Battery Charger/AC Adapter</p>	 <p>IA70A Power Supply</p>
 <p>FS-900 Multidyne Fiber Optic System</p>	<p>MCSH050D2PD2PXX (16m/52.5ft) MCSH082D2PD2PXX (25m/82ft) MCSH164D2PD2PXX (50m/164ft) MCSH246D2PD2PXX (75m/246ft) MCSH328D2PD2PXX (100m/328ft) MCSH410D2PD2PXX (125m/410ft) MCSH492D2PD2PXX (150m/492ft) MCSH574D2PD2PXX (175m/574ft) MCSH656D2PD2PXX (200m/656ft) Fiber Cables (Hybrid Cable/Optical CON)</p>	<p>MCSH050SIPSIRXX (16m/52.5ft) MCSH082SIPSIRXX (25m/82ft) MCSH164SIPSIRXX (50m/164ft) MCSH246SIPSIRXX (75m/246ft) MCSH328SIPSIRXX (100m/328ft) MCSH410SIPSIRXX (125m/410ft) MCSH492SIPSIRXX (150m/492ft) MCSH574SIPSIRXX (175m/574ft) MCSH656SIPSIRXX (200m/656ft) Fiber Cables (Hybrid Cable/SMPT304M)</p>
 <p>BR-DE900 Decoder</p>	 <p>BR-800 Broadcaster</p>	 <p>KA-SLCC100G ProHD Bridge Command Center</p>
 <p>PB-CELL200 Portable Wireless Bridge Cellular Uplink</p>	 <p>SFE-CAM Dockable Wireless Bridge Cellular Uplink</p>	

■ Specifications

GENERAL SPECIFICATIONS	Power	DC 12V (11V – 17V)	
	Power consumption	35W (with EVF, in REC mode, default setting)	
	Dimensions (W x H x D)	165 mm x 269 mm x 366 mm	
	Weight	Approx. 4.1 kg (9.0 lbs.) (Body only)	
	Operation temperature	0°C to 40°C	
	Storage temperature	-20°C to 50°C	
	Operating humidity	30% to 80%	
	Storage humidity	Under 85%	
CAMERA	Ingress protection	IPX2 equivalent	
	Image sensor	2/3-inch 2.2M pixels progressive 3 CMOS	
	Lens mount	2/3-inch B4 mount system	
	Sensitivity	F12 (60Hz), F13 (50Hz) at 2000lx (typical)	
	Shutter speed	1/3 to 1/10000, EEI	
	Gain	-6dB, -3dB, 0dB, 3dB, 6dB, 9dB, 12dB, 15dB, 18dB, 21dB, 24dB, 27dB, 30dB, Lolux (24dB, 30dB, 36dB, 42dB), AGC	
	ND filter	None, 1/4, 1/16, 1/64	
	S/N ratio	62dB	
	Viewfinder	3.26" OLED, WVGA (854 x 480), 16:9	
	LCD monitor	3.5" LCD, QHD (960 x 540), 16:9	
VIDEO/AUDIO RECORDING	Recording media	SDHC/SDXC memory card x 2 (HD: Class 6/10, SD/Web: Class 4, High-Speed: UHS-1 U3)	
	Video Recording	Video codec: MPEG-4 AVC/H.264 (HD/SD), MPEG-2 (HD) File format: MOV, MP4, MXF	
	Audio Recording	LPCM 2ch/4ch, 48kHz/16-bit (MOV/MXF), 48kHz/24bit (XHQ 4:2:2 10bit), μ -Low 2ch/4ch (Proxy), Exchange (MP4) AAC 2ch	
LIVE VIDEO STREAMING	Protocol	RTMP, MPEG2-TS/UDP, MPEG2-TS/TCP, MPEG2-TS/RTP, RTSP/RTP, Zixi	
	Resolution and bit rate	HD	1920 x 1080 (59.94p/59.94i/29.97p/50p/50i/25p) 20/16/12/8Mbps
			1920 x 1080 (59.94i/29.97p/50i/25p) 5/3Mbps
		SD	1280 x 720 (59.94p/50p) 20/16/12Mbps
LOW	1280 x 720 (59.94p/50p/29.97p/25p) 8/5/3Mbps		
	640 x 360 (59.94p/50p/29.97p/25p) 3/1.5/0.8/0.3Mbps		
INTERFACES	Video input	3G-SDI (BNC x 1)	
	Video output	3G-SDI (BNC x 2), HDMI x 1, Composite (BNC x 1)	
	VF terminal	26-pin	
	Audio input/output	XLR 3-pin x 2, (MIC, +48V, LINE)/XLR 5-pin	
	MIC input	XLR 5-pin	
	Genlock input	Genlock input (BNC x 1)	
	Time code input/output	BNC x 1/BNC x 1	
	Remote	mini DIN 6-pin x 1	
	USB	HOST (Type A USB 3.0) x 1 (Network)	
	Ethernet	RJ-45 x 1	
	DC input	XLR 4-pin x 1	
	DC output/Light DC output	4-pin x 2, D-tap x 1	
	Built-in slot	Wireless audio module (D-sub25 (UniSlot)) and optional future expansion	
Wireless LAN	Built-in (2.4 GHz/5 GHz)		
PROVIDED ACCESSORIES	Electronic viewfinder, Mount cap, Instruction manual (Basic)		

■ Recording Formats

System	Video Format	Resolution	Frame rate	Bit rate	Audio	Rec Time on 64GB SD Card	
HD	QuickTime/MXF (MPEG-2 Long GOP)	1920 x 1080	59.94i/50i/29.97p/25p	35Mbps (HQ)	LPCM 2ch/4ch 48kHz/16bit	192 min.	
		1440 x 1080	59.94i/50i			25Mbps (SP)	260 min.
		1280 x 720	59.94p/50p	50Mbps (XHQ 4:2:2 10-bit)			LPCM 2ch/4ch 48kHz/24bit 145 min.
		1440 x 1080	59.94i/50i			35Mbps (UHQ)	
	QuickTime (MPEG-4.AVC/H.264)	1920 x 1080	59.94p/59.94i/50p/50i/29.97p/25p/23.98p	50Mbps (LP)	AAC 2ch 48kHz/16bit		640 min.
		1280 x 720	59.94p/50p			8Mbps (LP)	48kHz/16bit
	Exchange MP4 (U model only)	1920 x 1080	59.94p/59.94i/50p/50i/29.97p/25p/23.98p	8Mbps (HQ)	LPCM 2ch/4ch 48kHz/16bit		
		1280 x 720	59.94p/50p			3Mbps (HQ)	μ -law 2ch/4ch 16kHz
SD	QuickTime (MPEG-4.AVC/H.264)	720 x 480 (U model)	59.94i	8Mbps (HQ)	LPCM 2ch/4ch 48kHz/16bit		
		720 x 576 (E/EC model)	50i			1.2Mbps (LP)	1920 min.
WEB (Proxy)	QuickTime (MPEG-4.AVC/H.264)	960 x 540	29.97p/25p/23.98p	3Mbps (HQ)	μ -law 2ch/4ch 16kHz		
		480 x 270	29.97p/25p/23.98p			50Mbps (XHQ)/35Mbps (UHQ)	—
High-Speed	QuickTime (MPEG-4.AVC/H.264)	1920 x 1080	120fps	59.94p/29.97p/23.98p	(Deffers by setting)		
			100fps	50p/25p			
			60fps	29.97p/23.98p			
			50fps	25p			

Note: 4:2:0 8-bit unless otherwise specified.

Product and company names mentioned here are trademarks or registered trademarks of their respective owners. "AVCHD Progressive" and "AVCHD Progressive" logo are trademarks of Panasonic Corporation and Sony Corporation. HDMI, the HDMI logo and High-Definition Multimedia Interface are trademarks or registered trademarks of HDMI Licensing LLC. Dolby is a trademark of Dolby Laboratories. Zixi and the Zixi logo are trademarks of Zixi LLC. The SD, SDHC and SDXC are trademarks of the SD Card Association.

Simulated pictures.
The values for weight and dimensions are approximate.
E.&O.E. Design and specifications subject to change without notice.
Copyright © 2019, JVCKENWOOD Corporation. All Rights Reserved.

JVCKENWOOD

DISTRIBUTED BY