

Panasonic®

Operating Instructions Functional Manual

Touch screen LCD display For business use

Model No. **TH-75BQE1W** 75-inch model



4K

PROFESSIONAL

*Actual resolution: 3840 × 2160p

HDMI

DOLBY AUDIO™

English

Please read these instructions before operating your set and retain them for future reference.



EU

DPQP1184ZB

Dear Panasonic Customer

Welcome to the Panasonic family of customers. We hope that you will have many years of enjoyment from your new LCD Display.

To obtain maximum benefit from your set, please read these Instructions before making any adjustments, and retain them for future reference.

Retain your purchase receipt also, and note down the model number and serial number of your set in the space provided on the rear cover of these instructions.

Visit our Panasonic Web Site

<http://panasonic.com>

Table of Contents

Before use

- Illustrations and screens in this Operating Instructions are images for illustration purposes, and may be different from the actual ones.
-

Important Safety Instructions..... 4

FCC STATEMENT..... 5

Important Safety Notice 6

Safety Precautions 7

Precautions for use 11

Chapter 1

Introduction..... 13

Checking the accessories 13

Remote Control Batteries 14

Names and functions of parts 15

Button and indicator..... 15

Cable and terminal 17

Remote control 18

How to use the remote control 19

Setting the remote control sensor..... 19

Operating range of remote control..... 19

Operating the remote control..... 19

Chapter 2

Installation..... 20

Connecting and fixing the power supply cord 20

Connecting with the analogue video source 21

Analogue connection 21

Connecting with the digital video source 21

Digital connection 21

Using the touch panel 22

Display settings..... 22

Using WhiteBoard software 22

Mounting sequence of the speaker 23

In the case of lateral placement..... 23

In the case of vertical placement..... 23

Chapter 3

Operation.....	25
Turn on the power supply of all connected devices ..	25
Power management function	27
Select the language of OSD	28
Select the input source	29
Select with the [INPUT] button of the remote control ..	29
Select with the [INPUT] button of the unit	29
Playback the contents of USB flash drive	30
Supported devices	31
Set the playlist	32
Play music in the background	34
Slideshow settings	34
Play the playlist	35
Control by the serial terminal	37
Configuration and basic operation of OSD screen ..	38
Basic operation of OSD screen	39
Menu screen of picture	41
Menu settings of aspect ratio	42
Menu screen of sound	43
Menu screen of settings	44
Menu screen of initial settings	45
Setting method of the scheduler	46
Menu screen of system information	47
Annex.....	48
Table 1: Specifications of the supported formats (video)	48
Table 2: Specifications of the supported formats (audio)	48
Table 3: Specifications of the supported formats (picture)	48
Table 4: Preset signal	49
Troubleshooting	50
Specifications	51



WARNING
RISK OF ELECTRIC SHOCK
DO NOT OPEN



WARNING: To reduce the risk of electric shock, do not remove cover or back.

No user-serviceable parts inside. Refer servicing to qualified service personnel.



The lightning flash with arrow-head within a triangle is intended to tell the user that parts inside the product are a risk of electric shock to persons.



The exclamation point within a triangle is intended to tell the user that important operating and servicing instructions are in the papers with the appliance.

WARNING:

To prevent damage which may result in fire or shock hazard, do not expose this apparatus to rain or moisture.

**Do not place containers with water (flower vase, cups, cosmetics, etc.) above the set.
(including on shelves above, etc.)**

WARNING:

- 1) To prevent electric shock, do not remove cover. No user serviceable parts inside. Refer servicing to qualified service personnel.
- 2) Do not remove the grounding pin on the power plug. This apparatus is equipped with a three pin grounding-type power plug. This plug will only fit a grounding-type power outlet. This is a safety feature. If you are unable to insert the plug into the outlet, contact an electrician.
Do not defeat the purpose of the grounding plug.

Important Safety Instructions

- 1) Read these instructions.
- 2) Keep these instructions.
- 3) Heed all warnings.
- 4) Follow all instructions.
- 5) Do not use this apparatus near water.
- 6) Clean only with dry cloth.
- 7) Do not block any ventilation openings. Install in accordance with the manufacturer's instructions.
- 8) Do not install near any heat sources such as radiators, heat registers, stoves, or other apparatus (including amplifiers) that produce heat.
- 9) Do not defeat the safety purpose of the polarized or grounding-type plug. A polarized plug has two blades with one wider than the other. A grounding type plug has two blades and a third grounding prong. The wide blade or the third prong are provided for your safety. If the provided plug does not fit into your outlet, consult an electrician for replacement of the obsolete outlet.
- 10) Protect the power cord from being walked on or pinched particularly at plugs, convenience receptacles, and the point where they exit from the apparatus.
- 11) Only use attachments / accessories specified by the manufacturer.
- 12) Use only with the cart, stand, tripod, bracket, or table specified by the manufacturer, or sold with the apparatus. When a cart is used, use caution when moving the cart / apparatus combination to avoid injury from tip-over. 
- 13) Unplug this apparatus during lightning storms or when unused for long periods of time.
- 14) Refer all servicing to qualified service personnel. Servicing is required when the apparatus has been damaged in any way, such as power-supply cord or plug is damaged, liquid has been spilled or objects have fallen into the apparatus, the apparatus has been exposed to rain or moisture, does not operate normally, or has been dropped.
- 15) To prevent electric shock, ensure the grounding pin on the AC cord power plug is securely connected.

FCC STATEMENT

This equipment has been tested and found to comply with the limits for a class A digital device, pursuant to Part 15 of the FCC Rules. These limits are designed to provide reasonable protection against harmful interference when the equipment is operated in a commercial environment. This equipment generates, uses and can radiate radio frequency energy and, if not installed and used in accordance with the instructions manual, may cause harmful interference to radio communications. Operation of this equipment in a residential area is likely to cause harmful interference in which case the user will be required to correct the interference at his own expense.

FCC CAUTION:

To assure continued compliance, follow the attached installation instructions and use only the provided power supply cord. Any changes or modifications not expressly approved by Panasonic Corp. of North America could void the user's authority to operate this device.

Declaration of Verification

Model No.

TH-75BQE1W

Responsible Party:

Panasonic System Solutions Company of North America

Two Riverfront Plaza, Newark, New Jersey
07102-5490

Contact Source:

Panasonic System Communications Company of North America
1-877-655-2357

General Contact:

<http://shop.panasonic.com/support>

This device complies with Part 15 of the FCC Rules and all applicable IC RSS standards. Operation is subject to the following two conditions: (1) This device may not cause harmful interference, and (2) this device must accept any interference received, including interference that may cause undesired operation.

CANADIAN NOTICE:

This Class A digital apparatus complies with Canadian ICES-003.

WARNING:

- Not for use in a computer room as defined in the Standard for the Protection of Electronic Computer/ Data Processing Equipment, ANSI/NFPA 75.
- For permanently connected equipment, a readily accessible disconnect device shall be incorporated in the building installation wiring.
- For pluggable equipment, the socket-outlet shall be installed near the equipment and shall be easily accessible.

Note:

Image retention may occur. If you display a still picture for an extended period, the image might remain on the screen. However, it will disappear when a general moving picture is displayed for a while.

Trademark Credits

- Microsoft, Windows and Internet Explorer are the registered trademarks or trademarks of Microsoft Corporation in the United States and/or other countries.
- Macintosh, Mac, Mac OS, OS X and Safari are the trademarks of Apple Inc. registered in the United States and other countries.
- HDMI, High-Definition Multimedia Interface and the HDMI Logo are trademarks or registered trademarks of HDMI Licensing Administrator, Inc. in the United States and other countries.
- Manufactured under license from Dolby Laboratories. Dolby and the double-D symbol are trademarks of Dolby Laboratories

Even if no special notation has been made of company or product trademarks, these trademarks have been fully respected.

Important Safety Notice

WARNING

- 1) To prevent damage which may result in fire or shock hazard, do not expose this appliance to dripping or splashing.
Do not place containers with water (flower vase, cups, cosmetics, etc.) above the set. (including on shelves above, etc.)
No naked flame sources, such as lighted candles, should be placed on / above the set.
- 2) To prevent electric shock, do not remove cover. No user serviceable parts inside. Refer servicing to qualified service personnel.
- 3) Do not remove the earthing pin on the power plug. This apparatus is equipped with a three pin earthing-type power plug. This plug will only fit an earthing-type power outlet. This is a safety feature. If you are unable to insert the plug into the outlet, contact an electrician.
Do not defeat the purpose of the earthing plug.
- 4) To prevent electric shock, ensure the earthing pin on the AC cord power plug is securely connected.

CAUTION

This appliance is intended for use in environments which are relatively free of electromagnetic fields.

Using this appliance near sources of strong electromagnetic fields or where electrical noise may overlap with the input signals could cause the picture and sound to wobble or cause interference such as noise to appear.

To avoid the possibility of harm to this appliance, keep it away from sources of strong electromagnetic fields.

WARNING:

This equipment is compliant with Class A of CISPR32. In a residential environment this equipment may cause radio interference.

IMPORTANT INFORMATION

If a display is not positioned in a sufficiently stable location, it can be potentially hazardous due to falling. Many injuries, particularly to children, can be avoided by taking simple precautions such as:

- Using cabinets or stands recommended by the manufacturer of the display.
- Only using furniture that can safely support the display.
- Ensuring the display is not overhanging the edge of the supporting furniture.
- Not placing the display on tall furniture (for example, cupboards or bookcases) without anchoring both the furniture and the display to a suitable support.
- Not standing the displays on cloth or other materials placed between the display and supporting furniture.
- Educating children about the dangers of climbing on furniture to reach the display or its controls.

**IMPORTANT: THE MOULDED PLUG
FOR YOUR SAFETY, PLEASE READ THE
FOLLOWING TEXT CAREFULLY.**

This display is supplied with a moulded three pin mains plug for your safety and convenience. A 10 amp fuse is fitted in this plug. Shall the fuse need to be replaced, please ensure that the replacement fuse has a rating of 10 amps and that it is approved by ASTA or BSI to BS1362.

Check for the ASTA mark  or the BSI mark  on the body of the fuse.

If the plug contains a removable fuse cover, you must ensure that it is refitted when the fuse is replaced.

If you lose the fuse cover the plug must not be used until a replacement cover is obtained.

A replacement fuse cover can be purchased from your local Panasonic dealer.
Do not cut off the mains plug.

Do not use any other type of mains lead except the one supplied with this display.

The supplied mains lead and moulded plug are designed to be used with this display to avoid interference and for your safety.

If the socket outlet in your home is not suitable, get it changed by a qualified electrician.

If the plug or mains lead becomes damaged, purchase a replacement from an authorized dealer.

WARNING : — THIS DISPLAY MUST BE EARTHED.

How to replace the fuse.

Open the fuse compartment with a screwdriver and replace the fuse.

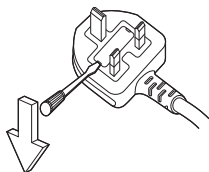

Safety Precautions

WARNING

■ Setup

This LCD Display is for use only with the following optional accessory.

Use with any other type of optional accessories may cause instability which could result in the possibility of injury.

(The following accessory is manufactured by Panasonic Corporation.)

Please firmly install the Pedestal sold separately. Installation should be done by a professional vendor.

Work in a team of 4 persons when installing.

Pedestal

- TY-ST75PE9

Note

- When installing the Pedestal, thoroughly read the instructions manual included with the product and correctly install the stand. Make sure to take the fall-prevention measures.
- For ensuring safety and performance, ask your distributor or a professional vendor to carry out the installation work.
- Please note that we will not be responsible for any product damage that happens due to defects in the installation environment of stand or wall-mounting clasp even if it is within the warranty period.
- For the products that you are no longer using, ask a professional contractor to promptly remove such products.
- When installing, "crack in LCD panel" may occur because of impact etc. Therefore, please carefully handle the product.
- The part numbers of optional items are subject to change without notice.

We are not responsible for any product damage, etc. caused by failures in the installation environment even during the warranty period.

Always be sure to ask a qualified technician to carry out set-up.

Small parts can present choking hazard if accidentally swallowed. Keep small parts away from young children. Discard unneeded small parts and other objects, including packaging materials and plastic bags/sheets to prevent them from being played with by young children, creating the potential risk of suffocation.

Do not place the Display on sloped or unstable surfaces, and ensure that the Display does not hang over the edge of the base.

- The Display may fall off or tip over.

Install this unit at a location with minimal vibration and which can support the weight of the unit.

- Dropping or falling of the unit may cause injury or malfunction.

Do not place any objects on top of the Display.

- If foreign objects or water get inside the Display, a short-circuit may occur which could result in fire or electric shock. If any foreign objects get inside the Display, please consult your local Panasonic dealer.

Transport only in upright position!

- Transporting the unit with its front panel facing upright or downward may cause damage to the internal circuitry.

Ventilation should not be impeded by covering the ventilation openings with items such as newspapers, table cloths and curtains.

For sufficient ventilation, see page 11.

Caution - For use only with UL Listed Wall Mount Bracket with minimum weight/load 68.0 kg (150.0 lbs).

When installing the Display vertically;

When installing the Display vertically, be sure that the Power Indicator comes to the downside. Heat is generated and it may cause fire or damage to the Display.

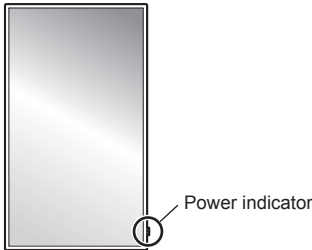

Cautions for Wall or Pedestal Installation

- The installation should be performed by an installation professional. Installing the Display incorrectly may lead to an accident that results in death or serious injury. Use the optional Pedestal. (see page 7)
- When installing on a wall, a wall hanging bracket that conforms to VESA standards must be used.
75-inch model : VESA 400 × 400
(see page 11)
- Before installation, be sure to check if the mounting location has enough strength to support the weight of the LCD display and the wall hanging bracket for anti drop.
- If you terminate the use of the Display on the Wall or Pedestal, ask a professional to remove the Display as soon as possible.
- When mounting the Display on the wall, prevent the mounting screws and power cable from contacting metal objects inside the wall. An electric shock may occur if they contact metal objects inside the wall.

Do not install the product to a place where the product is exposed to direct sunlight.

- If the unit is exposed to direct sunlight even indoors, the temperature rise of the liquid crystal panel may cause malfunction.

■ When using the LCD Display

The Display is designed to operate on 110 – 240 V AC, 50/60 Hz.

Do not cover the ventilation holes.

- Doing so may cause the Display to overheat, which can cause fire or damage to the Display.

Do not stick any foreign objects into the Display.

- Do not insert any metal or flammable objects into the ventilations holes or drop them onto the Display, as doing so can cause fire or electric shock.

Do not remove the cover or modify it in any way.

- High voltages which can cause severe electric shocks are present inside the Display. For any inspection, adjustment and repair work, please contact your local Panasonic dealer.

Ensure that the mains plug is easily accessible.

The mains plug shall be connected to a mains socket outlet with a protective earthing connection.

Do not use any power supply cord other than that provided with this unit.

- Doing so may cause short-circuit, generates heat, etc., which could cause electric shock or fire.

Do not use the supplied power supply cord with any other devices.

- Doing so could cause electric shock or fire.

Securely insert the power supply plug as far as it will go.

- If the plug is not fully inserted, heat may be generated which could cause fire. If the plug is damaged or the wall socket is loose, they shall not be used.

Do not handle the power supply plug with wet hands.

- Doing so may cause electric shocks.

Do not do anything that may damage the power cable. When disconnecting the power cable, pull on the plug body, not the cable.

- Do not damage the cable, make any modifications to it, place heavy objects on top of it, heat it, place it near any hot objects, twist it, bend it excessively or pull it. To do so may cause fire and electric shock. If the power cable is damaged, have it repaired at your local Panasonic dealer.

Do not touch the power supply cord or the plug directly by hand when they are damaged.

- Electric shock could occur.

Do not remove covers and NEVER modify the Display yourself.

- Do not remove the rear cover as live parts are accessible when it is removed. There are no user serviceable parts inside. (High-voltage components may cause serious electrical shock.)
- Have the Display checked, adjusted, or repaired at your local Panasonic dealer.

Keep the screws (supplied) out of reach of children. If accidentally swallowed, it will be harmful to the body.

- Please contact a doctor immediately in case you doubt that the child may have swallowed it.

When using the unit in an area where there are passers-by, do not connect the USB cable for the touch panel to the PC.

Doing so may cause them to bump into the unit, or their feet may be entangled in the USB cable, resulting in a fire, electric shock or injury.

- When using the unit in an area where there are passers-by, provide an enclosure around the unit to prevent people from approaching it.

If the Display is not going to be used for any prolonged length of time, unplug the power supply plug from the wall outlet.

Picture noise may occur if you connect / disconnect the cables connected to the input terminals you are currently not watching, or if you turn the power of the video equipment on / off, but it is not a malfunction.

To prevent the spread of fire, keep candles or other open flames away from this product at all times.



CAUTION

If problems or malfunction occur, stop using immediately.

■ If problems occur, unplug the power supply plug.

- Smoke or an abnormal odour come out from the unit.
- No picture appears or no sound is heard, occasionally.
- Liquid such as water or foreign objects got inside the unit.
- The unit has deformed or broken parts.

If you continue to use the unit in this condition, it could result in fire or electric shock.

- Turn the power off immediately, unplug the power supply plug from the wall outlet, and then contact the dealer for repairs.
- To cut off the power supply to this Display completely, you need to unplug the power supply plug from the wall outlet.
- Repairing the unit yourself is dangerous, and shall never be done.
- To enable to unplug the power supply plug immediately, use the wall outlet which you can reach easily.

■ Do not touch the unit directly by hand when it is damaged.

Electric shock could occur.

■ When using the LCD Display

Do not bring your hands, face or objects close to the ventilation holes of the Display.

- Heated air comes out from the ventilation holes at the top of Display will be hot. Do not bring your hands or face, or objects which cannot withstand heat, close to this port, otherwise burns or deformation could result.

4 people are required to carry or unpack this unit.

- If this is not observed, the unit may drop, resulting in injury.

Always work in a team of 4 persons when attaching or removing the speakers supplied in the accessory.

- The display unit may fall down and it may cause injury.

Be sure to disconnect all cables and overturn prevention accessories before moving the Display.

- If the Display is moved while some of the cables are still connected, the cables may become damaged, and fire or electric shock could result.

Do not apply too much force or impact shock.

- The front panel may crack, resulting in injury.

Disconnect the power supply plug from the wall socket as a safety precaution before carrying out any cleaning.

- Electric shocks can result if this is not done.

Clean the power cable regularly to prevent it becoming dusty.

- If dust built up on the power cord plug, the resultant humidity can damage the insulation, which could result in fire. Pull the power cord plug out from the wall outlet and wipe the mains lead with a dry cloth.

Do not step on, or hang from the display or the Pedestal.

- They might tip over, or might be broken and it may result in injury. Pay special attention to the children.

Do not reverse the polarity (+ and -) of the battery when inserting.

- Mishandling the battery may cause its explosion or leakage, resulting in fire, injury or damage to surrounding properties.
- Insert the battery correctly as instructed. (see page 14)

Do not use batteries with the outer cover peeling away or removed.

(The outer cover is attached to the battery for safety. It must not be removed. Doing so may cause short circuits.)

- Mishandling the batteries may cause the batteries to short circuit, resulting in fire, injury or damage to surrounding properties.

Remove the batteries from the remote control transmitter when not using for a long period of time.

- The battery may leak, heat, ignite or burst, resulting in fire or damage to surrounding properties.

Do not burn or breakup batteries.

- Batteries must not be exposed to excessive heat such as sunshine, fire or the like.

Do not turn the Display upside down.

Do not position the unit with its liquid crystal panel facing upright.

Parts of the unit become hot.

- Even when the temperature of parts of the front panel surface, top and rear of the unit has risen, these temperature rises will not pose any problems in terms of performance or quality.

Precautions for use

Cautions when installing

Do not set up the Display outdoors.

- The Display is designed for indoor use.

Install this unit at a location which can support the weight of the unit.

- Use the installation bracket that conforms to VESA standards

Environmental temperature to use this unit

- When using the unit where it is below 1 400 m (4 593 ft) above sea level: 0 °C to 40 °C (32 °F to 104 °F)
- When using the unit at high altitudes (1 400 m (4 593 ft) and higher and below 2 800 m (9 186 ft) above sea level): 0 °C to 35 °C (32 °F to 95 °F)

Do not install the unit where it is 2 800 m (9 186 ft) and higher above sea level.

- Failure to do so may shorten the life of the internal parts and result in malfunctions.

We are not responsible for any product damage, etc. caused by failures in the installation environment even during the warranty period.

Do not place the display where it may be affected by salt or corrosive gas.

- Failure to do so may shorten the life of the internal parts and result in malfunctions due to corrosion.

Required space for ventilation

- When using the Pedestal (optional accessory), leave a space of 10 cm (3 15/16") or more at the top, left and right, and 5 cm (1 31/32") or more at the rear, and also keep the space between the bottom of the display and the floor surface.

If using some other setting-up method (wall-hanging, etc.), follow the manual of it. (If there is no specific indication of installation dimension in the installation manual, leave a space of 10 cm (3 15/16") or more at the top, bottom, left and right, and 5 cm (1 31/32") or more at the rear.)

Minimum distance:

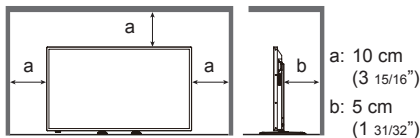

- Operation of this unit is guaranteed up to an ambient temperature of 40 °C (104 °F). When installing the unit in a case or chassis, be sure to provide adequate ventilation with a cooling fan or ventilation hole so that the surrounding temperature (inside the case or chassis) including the temperature of the front surface of the liquid crystal panel can be kept at 40 °C (104 °F) or less.

About the screws used when using a wall hanging bracket that conforms to VESA standards

Inch model	Screw pitch for installation	Depth of screw hole	Screw (quantity)
75	400 mm × 400 mm	25 mm	M6 (4)

Be careful of the movable structure of the power indicator and remote control sensor.

- As factory default, the power indicator and remote control sensor are stored in the main unit. In normal cases, pull the remote control sensor box from the end face of the unit until it gets locked at the designated position. Depending on the setup condition such as when using the multi display, store the remote control sensor in the main unit. (see page 19, 25)

Depending on the temperature or humidity conditions, uneven brightness may be observed. This is not a malfunction.

- This unevenness will disappear while applying current continuously. If not, consult the distributor.

Cleaning and maintenance

First, remove the mains plug from the mains socket.

The front panel surface has been specially treated.

Wipe the surface of the front panel gently using only a cleaning cloth or a soft, lint-free cloth.

- If the surface is particularly dirty, wipe with a soft, lint-free cloth which has been soaked in pure water or water in which neutral detergent has been diluted 100 times, and then wipe it evenly with a dry cloth of the same type until the surface is dry.

Wipe off dirt on the IR transmission part with soft cloth.

- Wipe off dirt on the IR transmission part with soft cloth once a day.

If malfunction is due to dirt on the IR transmission part, simply wiping it off lightly can recover the performance.

If dirt is sticky, wipe it off with cloth wrung out of neutral detergent diluted with water and then wipe the part with dry cloth.

- If the substance such as the material of the supplied pen is stuck on the glass surface, wipe it with a wet cloth.

Note that if a deep scratch is caused by using objects other than the supplied pen, it may not be wiped off.

- Do not scratch or hit the surface of the front panel with fingernails or other hard objects, otherwise the surface may become damaged. Furthermore, avoid contact with volatile substances such as insect sprays, solvents and thinner, otherwise the quality of the surface may be adversely affected.

If the cabinet becomes dirty, wipe it with a soft, dry cloth.

- If the cabinet is particularly dirty, soak the cloth in water to which a small amount of neutral detergent has been added and then wring the cloth dry. Use this cloth to wipe the cabinet, and then wipe it dry with a dry cloth.
- Do not allow any detergent to come into direct contact with the surface of the Display. If water droplets get inside the unit, operating problems may result.
- Avoid contact with volatile substances such as insect sprays, solvents and thinner, otherwise the quality of the cabinet surface may be adversely affected or the coating may peel off. Furthermore, do not leave it for long periods in contact with articles made from rubber or PVC.

Usage of a chemical cloth

- Do not use a chemical cloth for the panel surface.
- Follow the instructions for the chemical cloth to use it for the cabinet.

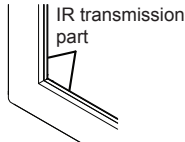

Touch panel

Carefully observe the following instructions as the display has an optical touch panel.

Do not expose the display to direct sunlight or strong light source during use.

- Otherwise malfunction may occur since the optical touch panel of the display uses infrared rays.

Always use a finger or the supplied pen to operate the touch panel. Do not use a hard or sharp tip such as nail, ball-point pen, and pencil.

When using any other infrared device, keep a distance to prevent erroneous operation.

When installing multiple units

When installing multiple units side by side, infrared rays of each unit may penetrate into the IR transmission parts of the adjacent displays, resulting in malfunction of touch panels.

Install the units in such a way that the displays are not affected mutually.

Disposal

When disposing the product, ask your local authority or dealer about the correct methods of disposal.

Chapter 1

Introduction

Checking the accessories

Check that you have all accessories.

- Operating Instructions**
(CD-ROM × 1)

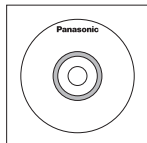

- Power Supply Cord**
(Approx. 2 m)

- 1JP155AF1U

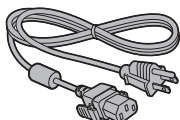

- 1JP155AF1W

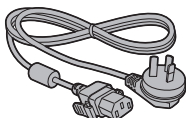

- 2JP155AF1W

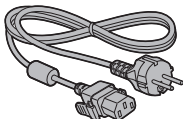

- 3JP155AF1W

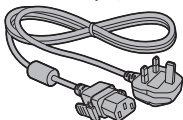

- Remote Control × 1**
• DPVF1671ZA



- Batteries for the Remote Control Transmitter × 2**
(AA/R6/LR6 type)

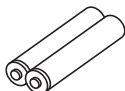

- Pen × 1**
• TKR5ZA45001

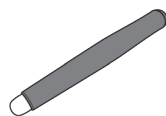

- Clamper × 3**
• DPVF1697ZA



- Speaker × 1**
• DPVF1698ZA

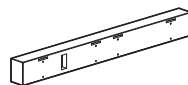

- Speaker Mounting Clasp × 2**

- DPVF1709ZA (Left)
- DPVF1710ZA (Right)

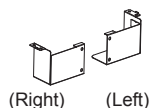

(These clasps are assembled with the speaker and supplied with it.)

- Screw for Mounting the Speaker (M3) × 4**

- DPVF1701ZA



- Speaker Cable × 2**
(Approx. 0.7 m)

- DPVF1702ZA



Attention

- Store small parts in an appropriate manner, and keep them away from young children.
- The part numbers of accessories are subject to change without notice.
(The actual part number may differ from the ones shown above.)
- In case you have lost accessories, please purchase them from your dealer. (Available from the customer service)
- Dispose the packaging materials appropriately after taking out the items.

Remote Control Batteries

Open the battery cover.

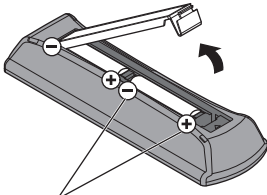

AA/R6/LR6 type

Insert batteries and close the battery cover.

(Insert starting from the ⊖ side.)

Note

- Incorrect installation of the batteries can cause battery leakage and corrosion that will damage the remote control.
- Disposal of batteries should be done in an environment-friendly manner.

Take the following precautions.

1. Batteries shall always be replaced as a pair.
2. Do not combine a used battery with a new one.
3. Do not mix battery types (example; manganese dioxide battery and alkaline battery etc.).
4. Do not attempt to charge, disassemble, or burn used batteries.
5. Do not burn or breakup batteries.

Moreover, batteries must not be exposed to excessive heat such as sunshine, fire or the like.

Names and functions of parts

■ Button and indicator

Back side

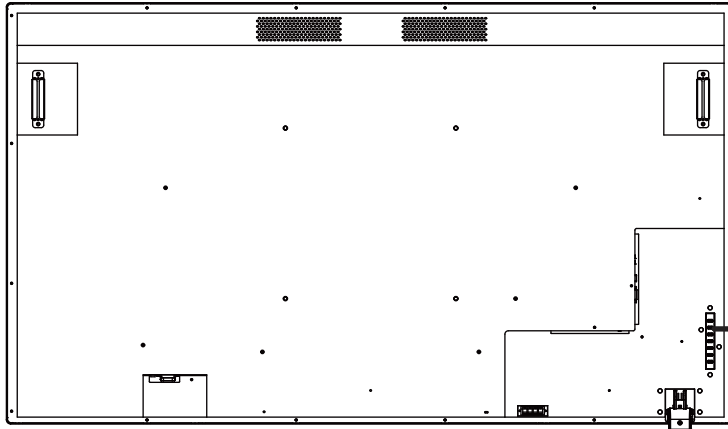

Control button

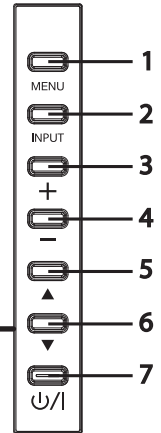

- | | | |
|---|-----------------------------|---|
| 1 | [MENU] button | It shows the on-screen display (OSD) menu. |
| 2 | [INPUT] button | It shows the OSD menu and changes the input source.
You can select [HDMI1], [HDMI2], [DVI-D], [PC], and [USB] with the up (▲) / down (▼) buttons. |
| 3 | Plus (+) button | It increases the volume. |
| 4 | Minus (-) button | It lowers the volume. |
| 5 | Up (▲) button | It moves up the item highlighted in the OSD menu. |
| 6 | Down (▼) button | It moves down the item highlighted in the OSD menu. |
| 7 | [POWER] button (⏻/⏿) | It turns ON/OFF the power supply. This button cannot be operated when the power indicator is turned off. In this case, turn on the Main power switch. (see page 16) |

Back side

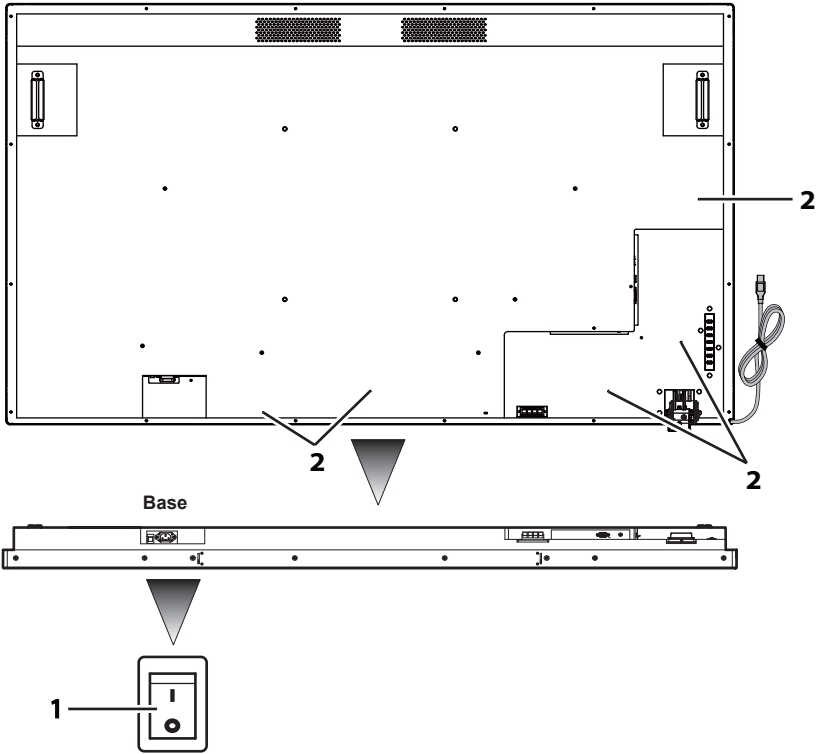

1 Main power switch

It turns "Off (O) / On (I)" the main power supply. It is used for starting / stopping power supply to the device.

2 Hole for cable clamp installation

It is used for fastening cable with the main unit.

Cable and terminal

Refer to page 21 for the details of types of cables and how to connect them.

Back side

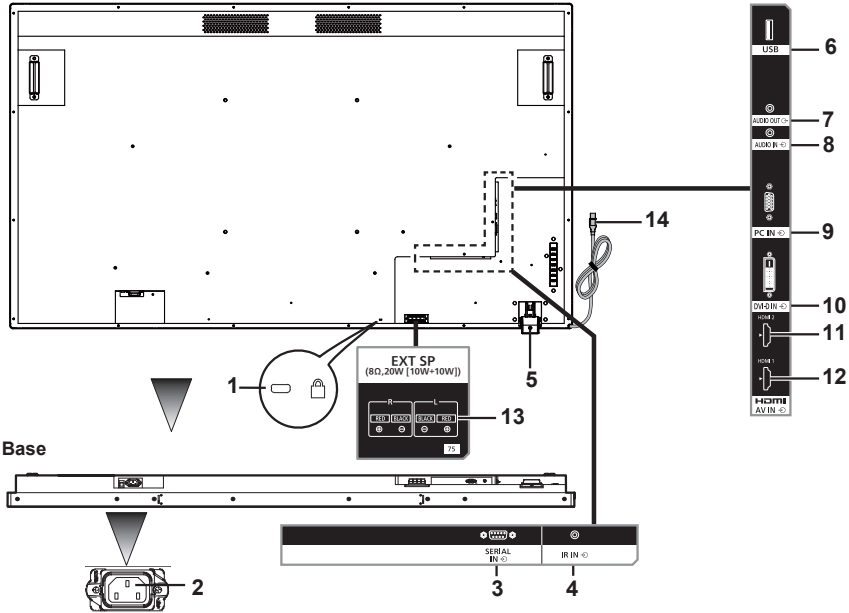

- 1 Hole for installing theft prevention lock** It is used for security and theft prevention.
- 2 AC IN (3-pin, with earthing terminal)** It is connected with the power supply cord provided in accessories. For Class I products, it is mandatory to connect the main power supply having earthing.
- 3 SERIAL IN** It is used for connecting to a PC for controlling the main unit.
- 4 IR IN** It is an IR input terminal that is connected with an IR cable. Please contact your distributor for purchasing an IR cable.
- 5 Remote control sensor / Power indicator** Remote control sensor: It receives signals from the remote control.
Power indicator: It shows the status of LCD display.
See page 27 for more details.
- 6 USB** It is a USB input terminal for USB flash drives.
- 7 AUDIO OUT** This terminal is for connecting a speaker having amplifier. It will output audio when [AUDIO OUT] is specified in [Sound] - [Output Select]. Output can be adjusted with the [VOL] button (+/-) of the remote control.
- 8 AUDIO IN** It is used for connecting audio output cables of external devices such as PC, VCR, and DVD player. For HDMI input, you can select [AUDIO IN] in [Sound] - [Audio Source]. (see page 43)
[AUDIO IN] is default in DVI-D/PC input.
- 9 PC IN** It is used for connecting with the analogue video signal output terminal of a PC.
- 10 DVI-D IN** It is connected with a digital video signal output terminal such as a PC.
- 11 HDMI 2** It is used for connecting with a device compatible with audio / video signal of HDMI interface.
- 12 HDMI 1** It is used for connecting with a device compatible with audio / video signal of HDMI interface.
- 13 EXT SP** It is connected with L/R and +/- terminal of the speaker provided as accessory.
It will output audio when [EXT SP] is specified in [Sound] - [Output Select]. Output can be adjusted with the [VOL] button (+/-) of the remote control.
- 14 USB cable for touch panel** It is connected to a PC's USB terminal for using the touch panel.

Remote control

- | | | |
|----------------------------------|--|-----------|
| 1 [POWER] | It turns ON/OFF the power supply. Remote control cannot be operated when the power indicator is turned off. | 3 |
| 2 [AUTO ADJUST] | It shows the automatic adjustment selection menu during PC input. | 4 |
| 3 [PICTURE STYLE] | It shows the settings menu of the image mode for the displayed input. | 7 |
| 4 [SOUND STYLE] | It shows the settings menu of the audio mode for the displayed input. | 8 |
| 5 [PICTURE] | It shows the image settings menu for the displayed input. | 10 |
| 6 [SOUND] | It shows the audio settings menu for the displayed input. | 12 |
| 7 [SET UP] | It shows the [Setup] menu. | 13 |
| 8 [ASPECT] | It shows the settings menu of aspect ratio. | 14 |
| 9 [MENU] | It turns ON/OFF the OSD menu. | 15 |
| 10 [RETURN] | It is used for going back to the previous menu screen. | 17 |
| 11 Cursor buttons | They are used for operating the menu screen. | 19 |
| 12 [OK] | It is used for selecting menu items. | 21 |
| 13 [EXIT] | It turns OFF the OSD menu. | 22 |
| 14 [INFO] | It shows the selected input source. | 23 |
| 15 [MEDIA CONTROL] | It provides various control functions of a specific menu. Function of each button will appear in OSD in the colour of the respective button. | 24 |
| 16 [VOL] | Pressing the plus (+) side will increase the audio output level.
Pressing the minus (-) side will decrease the audio output level. | 25 |
| 17 [SLEEP] | It adjusts the sleep timer. | |
| 18 [MUTE] | It mutes the audio. Press once again to unmute.
Turning off the power supply and changing the volume level will restore the audio. | |
| 19 [INPUT] | It is used for changing the input source. | |
| 20 [HDMI] | It is used for selecting HDMI input. | |
| 21 [DVI] | It is used for selecting DVI-D input. | |
| 22 [PC] | It is used for selecting PC input. | |
| 23 Media operation button | It provides control functions when a media file is playing. Rewind (<<), Play (>), Fast forward (>>), Previous (<<), Stop (□), Pause (⏸), Next (>>). | |
| 24 [USB] | It is used for selecting USB input. | |
| 25 [-] | Not supported in this device. | |

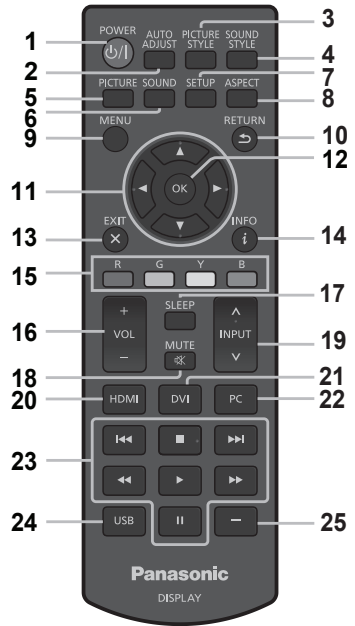

How to use the remote control

■ Setting the remote control sensor

Before using the remote control, decide the position of remote control sensor of LCD display.

The remote control sensor is the small black box located on the left side of the back of LCD display.

Slide and pull the remote control sensor box from the back side of LCD display until it gets locked in the designated position.

Follow these steps in the opposite order for returning the sensor to its original position.

■ Operating range of remote control

Operate the remote control from the front side of remote control sensor or by keeping it towards the remote control sensor from the direction where the remote control sensor can be seen.

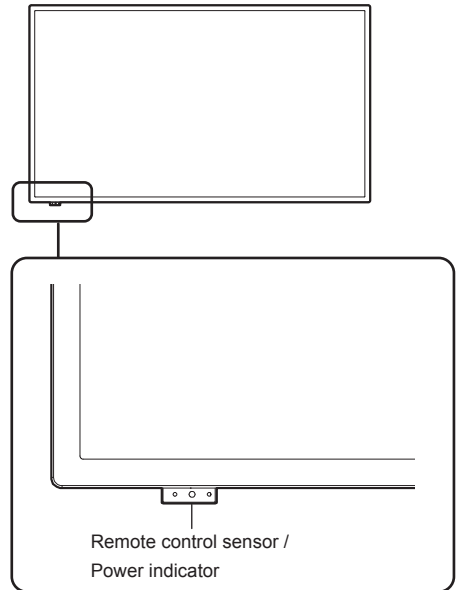

Note

- The remote control system may not function if the remote control sensor of LCD display is exposed to direct sunlight or strong lighting, or if there is an obstacle in the sensor's trajectory.
- You can check whether the power indicator has light up or not by pulling the remote control sensor box.

■ Operating the remote control

- Do not make strong impact shock.
- Ensure that remote control is not exposed to liquids such as water. If the remote control gets wet, immediately wipe it off.
- Do not expose the remote control to heat or steam.
- Do not open the remote control cover except when inserting batteries.

Chapter 2

Installation

Connecting and fixing the power supply cord

Back side of the unit

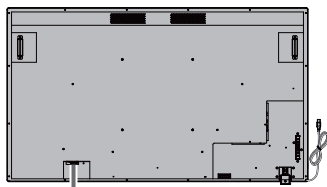

Fixing the power supply cord

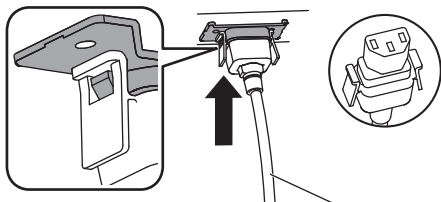

Power supply cord (supplied)

Insert the connector in the main unit

Insert until you hear the clicking sound.

Note

- Check that both sides are locked.

When removing the power supply cord

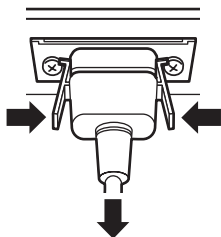

Remove while pressing the knobs located next to the connector.

Note

- When removing the power supply cord, make sure to first remove the power supply plug on the power socket side.
- The power supply cord provided in the accessories is for exclusively using with the device. Do not use it for any other purpose.

Fixing the connection cables

Note

- Three clampers are provided as accessories with the device. When not using the touch panel, use one of the clampers to fix the USB cable for touch panel at the position of A. Moreover, with the other two clampers, fix the other cables at the position of B. If you wish to purchase clampers, please contact your dealer. (Available from the customer service)

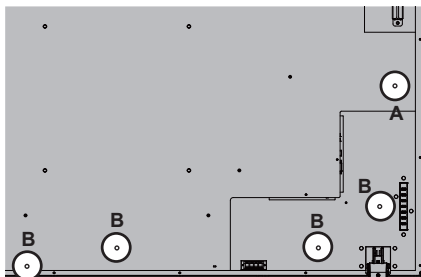

1. Mounting the clampers

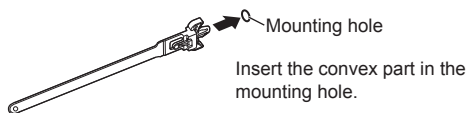

Mounting hole

Insert the convex part in the mounting hole.

Note

- Once you mount the clampers in the clamer mounting holes, you will not be able to remove them.

2. Bundling the cables

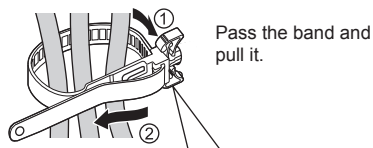

Pass the band and pull it.

Loosening the band

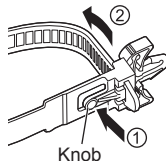

Pull the tip of the band while pressing the knob.

Knob

Connecting with the analogue video source

■ Analogue connection

- 1 Connect the signal cable (PC cable) with the PC IN terminal.
- 2 Select [PC] by using the [INPUT] button of LCD display, or the [\wedge / \vee] button of the remote control where [INPUT] is indicated. Selecting this will automatically change audio to [AUDIO IN].

Note

- You can also directly select [PC] by using the [PC] button of the remote control.

Audio connection:

Connect the audio cable (\varnothing 3.5 mm stereo mini plug (commercially available)) to the AUDIO IN connector. Audio will automatically change to [AUDIO IN]. Therefore, audio will output by just connecting the cable.

Connecting with the digital video source

■ Digital connection

Connection through HDMI terminal

- 1 Connect the commercially available HDMI cable to the HDMI 1 or HDMI 2 terminal.
- 2 Select [HDMI1] or [HDMI2] according to the connector that is connected by using the [INPUT] button of LCD display, or the [\wedge / \vee] button of the remote control where [INPUT] is displayed.

Note

- You can also directly select [HDMI1] or [HDMI2] by using the [HDMI] button of the remote control.

Audio connection during HDMI input:

You can select HDMI and AUDIO IN for HDMI input. (see page 43)

Connection through DVI-D IN terminal

- 1 Connect the commercially available DVI-D cable to the DVI-D IN terminal.
- 2 Select [DVI-D] by using the [INPUT] button of LCD display or the [INPUT] button of the remote control.

Note

- You can also directly select [DVI-D] by using the [DVI] button of the remote control.

Audio connection during DVI-D input:

Only AUDIO IN input is available in DVI-D input.

Note

- Depending on the outer shape of the plug, it may come in contact with the plug of the adjacent connection cables or peripheral parts such as back cover. Please use the connection cable of the plug size appropriate for the mounting.
- Because of the structure of the terminal area, you may not be able to use some cables depending on the connection cable / USB flash drive. Please make sure to check 'terminal area drawing' provided in the specifications.

https://panasonic.net/cns/prodisplays/download/spec_manual/

Using the touch panel

- 1 Turn off the Main power switch of the display.
- 2 Connect the computer and the USB cable of the display.
- 3 Connect the computer and the video input terminal of the display. (see page 21)
- 4 Turn on the Main power switch of the display. If required, press the [POWER] button of the remote control to turn on the display.

■ Display settings

Please make the following display settings.

- Switch the input signal to the video input from the computer.
- Set the screen position such that the computer's screen correctly appears on the display.

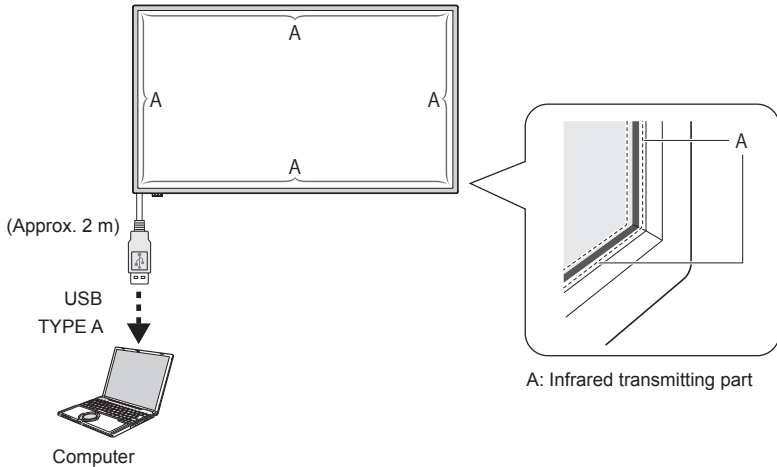

Note

- Pulling the USB cable with excessive force may result in the breakdown of the touch panel. Therefore, handle it carefully.
- For preventing disconnection of the USB cable for touch panel, fix it with the device by using the clammer. (see page 20)
- Wipe off dirt on the infrared transmitting part with a soft cloth.

Wipe off dirt on the infrared transmitting part with a soft cloth once in a day. When a defect has occurred because of dirt on the infrared transmitting part, lightly wiping it will restore the function. If the infrared transmitting part is heavily soiled, dip the cloth in a neutral cleaning agent diluted with water and firmly squeeze it. Use this cloth and gently clean the infrared transmitting part. Finally, wipe it with a dry cloth.

Using WhiteBoard software

WhiteBoard software allows you to use various functions, for example, you can capture documents and pictures, draw with pen, etc.

- 1 Obtain the WhiteBoard software (Windows / Mac) from the support site below.
<https://panasonic.net/cns/prodisplays/>
- 2 For details of operation, refer to the manual of WhiteBoard software on the site above.

Mounting sequence of the speaker

Mount the speaker (supplied).

A cross slot screw driver is required for assembling. Therefore, arrange it in advance.

1 Preparing the display

Work in a team of 4 persons when installing.

Spreading out a soft cloth, etc., place the display with the screen facing down.

- Be careful not to damage the display screen, for example, by dragging it.
- When placing the display with the screen facing down, or lifting it up, never hold or put pressure on the front panel. Inside of the front panel may be damaged.

2 As shown in the figure below, mount the speaker on the display.

Fix the speaker with 2 speaker mounting clasps and 4 speaker mounting screws (supplied).

Tightening torque: 0.5 to 0.8 N·m

Note

- Speaker mounting clasps are assembled with the speaker and supplied with it.

■ In the case of lateral placement

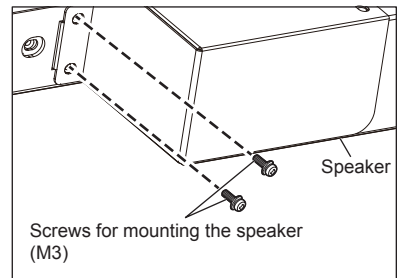
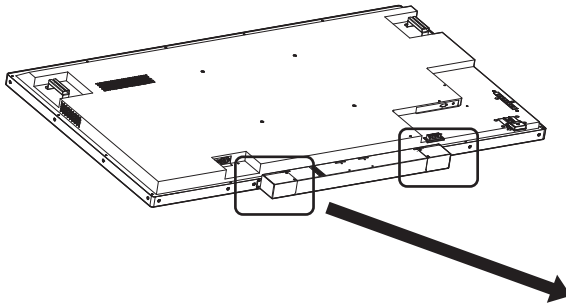

*Fix the opposite side in the symmetric position.

■ In the case of vertical placement

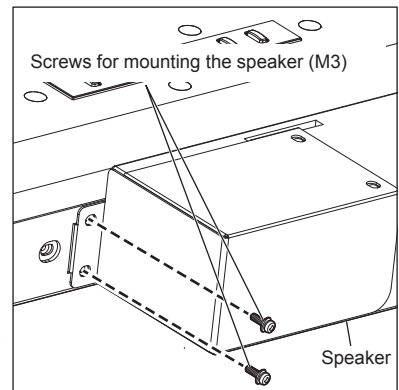
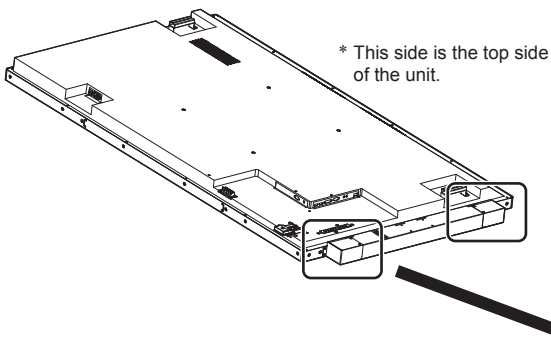

*Fix the opposite side in the symmetric position.

3 Connecting the speaker cables

With the 2 speaker cables (supplied), connect the EXT SP terminal of the display and the speaker.

Note

- Connect the R terminal on the display to the R terminal on the speaker, and the same applies for the L terminals on them.
- Connect the red terminal on the display to the red terminal on the speaker, and the same applies for the black terminals on them.
- When connecting the speaker cable, please take precaution so that short circuit doesn't happen in the core wire.

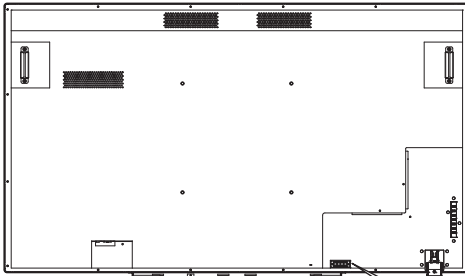

1. While pushing the lever

2. Insert the cable
3. Release the lever

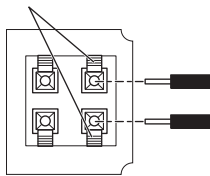

1. Pushing down the lever

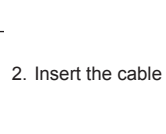

2. Insert the cable

3. Return the lever

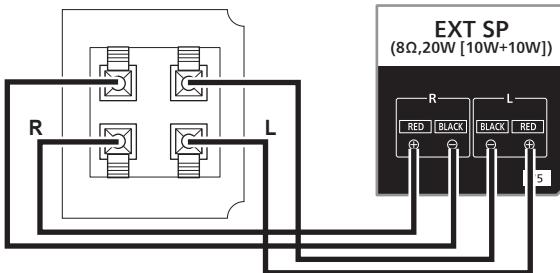

Mount the clammer (supplied) at the following places, and then fix the cable.

When the cable is long, bundle and fix the cable using this clammer.

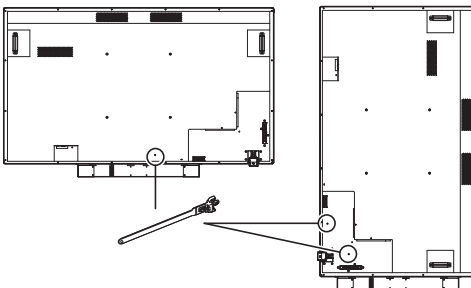

Chapter 3

Operation

Turn on the power supply of all connected devices

- 1 Turn on the power supply of all connected devices such as PC and DVD player.
- 2 Set the remote control sensor.

Before using the remote control, decide the position of remote control sensor of LCD display.

Remote control sensor is the small black box located on the left side of the back of LCD display. Until the sensor gets locked at the designated position, push the position of A with thumb etc. and slide it in the downward direction (refer to bottom right of the illustration).

Follow these steps in the opposite order for returning the sensor to its original position.

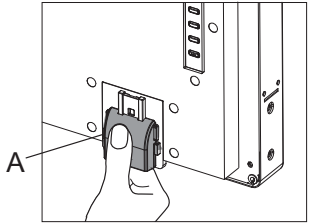
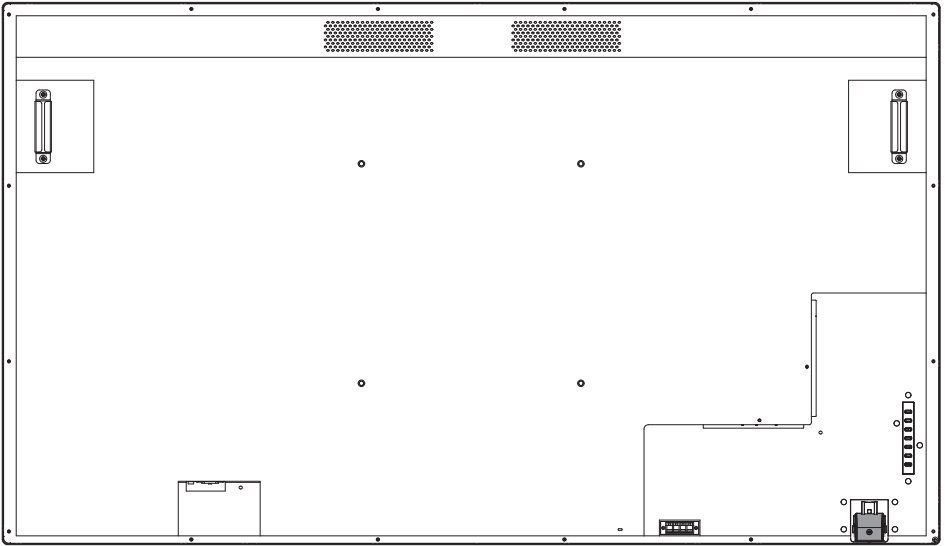

When the remote control sensor is stored

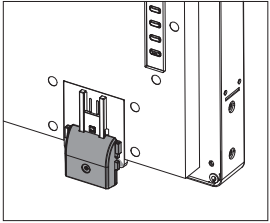

When the remote control sensor is used

3 Turn on the Main power switch.

The power indicator will light up, and you can now operate remote control and control buttons on the back side, avail serial control, and enable the scheduler.

When the Main power switch is off (power indicator is light out), control buttons on the back side, remote control, and the settings of scheduler will not work. For using these, check that the Main power switch is on (power indicator has light up).

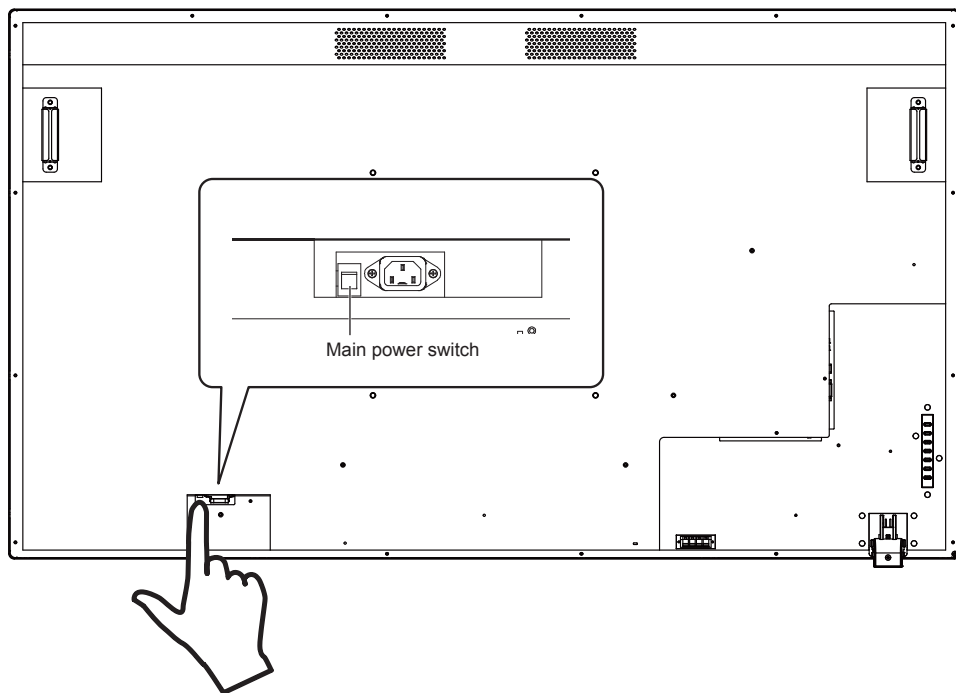

4 Turn on the device.

Press the [POWER] button located on the left side of the device, or the [POWER] button located on top left of the remote control.

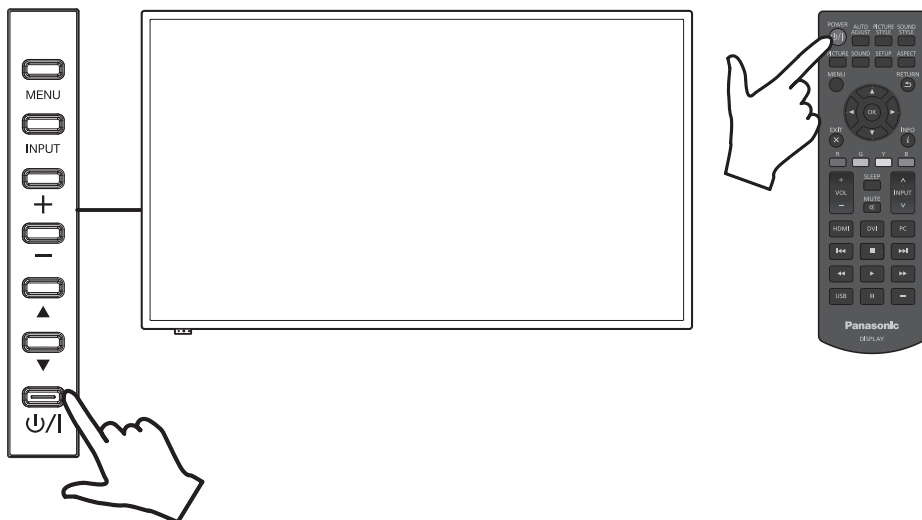

■ Power management function

In terms of power saving feature, the device supports the following 4 power off functions.

[Sleep Timer]

- You can set the timer and turn off the power supply of the display irrespective of the current status of signal of the source.
You can set the sleep timer in the OSD menu to [5 Min], [15 Min], [30 Min], [60 Min], [90 Min], [120 Min], [180 Min], and [Off].
- This value will not be saved. Only one value will be executed. Default setting is [Off].

[Power Management Setting]

- It will turn off the power supply of the display (standby mode) when there is no input signal from the current source. This is applicable to HDMI/DVI-D/PC input. This setting can be adjusted in the range of 30 seconds to 300 seconds or can be set to [Disable].
- This value will be saved. Default setting is [300 Sec].
- When the power supply is turned off (standby mode) because of this function, if the signal is once again fed to the same input that turned off, power supply of the display will turn on.
- It will show the remaining number of seconds starting from 20 seconds before the power supply turns off.

Note

- Power management function may not work normally depending on the video output device. In this case, set this function to [Off].

[No Activity Power Off]

- If this is set to [Enable], the power supply will automatically turn off (standby) when the device is not operated for more than 4 hours.
- It will show the remaining time starting from 3 minutes before the power supply turns off.
- When the power supply has turned off because of this function, [Last turn off due to 'No Activity Power Off'.] will appear when the power supply is started next time.

[Scheduler]

- You can set 7 schedules that decide the power supply on time and the power supply off time. Refer to the Scheduler function for detailed settings. (see page 46)

Note

- The display has the priority mode that sets priority of each setting. (see page 44)
 - The settings of [Scheduler] will have higher priority than the settings of [Sleep Timer] and power management.
 - [Sleep Timer] and power management has the same priority. When both are enabled, power supply off time is decided depending on the setting of power management or [Sleep Timer].

Power indicator	
Status	LED
Main power supply off	Light out
Power supply off mode	Red
Power supply standby when [Scheduler] is enabled	Orange
Power supply on mode	Green
Diagnosis (defects are detected)	When blinks in red colour: Contact your dealer.

Select the language of OSD

Press the [MENU] button located on the remote control or the left side of LCD display to start the OSD menu.

You can select the language of OSD by using the [Menu Language] located in the [Initial Setting] menu on the OSD menu screen. See page 45.

Select the input source

■ Select with the [INPUT] button of the remote control



You can select your target input source by using the [^ / v] button of the remote control where [INPUT] is indicated.

Options of the input source are [HDMI1], [HDMI2], [DVI-D], [PC], and [USB].

Note

- You can also directly select [HDMI1] / [HDMI2] / [DVI-D] / [PC] / [USB] by using the [HDMI] / [DVI] / [PC] / [USB] buttons of the remote control.

■ Select with the [INPUT] button of the unit

Pressing the [INPUT] button of the unit will show the OSD menu of the input source. You can select your target input source by using the up (▲) / down (▼) buttons.

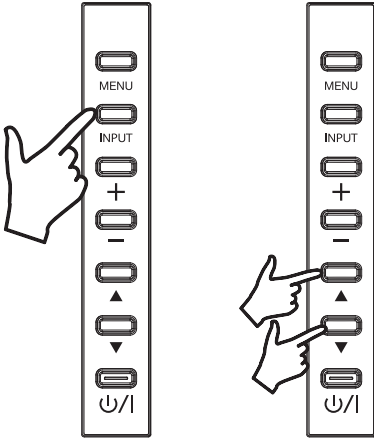

Options of the input source are [HDMI1], [HDMI2], [DVI-D], [PC], and [USB]. Pressing the [INPUT] button once again will show the selected input source.

The selected input source will be automatically entered after few seconds.

Playback the contents of USB flash drive

- 1 Insert the USB flash drive in the USB input terminal.
- 2 Select USB as the input source by using the [INPUT] button of the remote control or the LCD display.

Note

- You can also directly select [USB] by using the [USB] button of the remote control.
- 3 3 options of [PHOTO], [MUSIC], and [MOVIE] will appear in the OSD main menu (media root page). Use the left (◀) and the right (▶) buttons of the remote control and select the type of the contents you want to play. Press the [OK] button to confirm the selection.

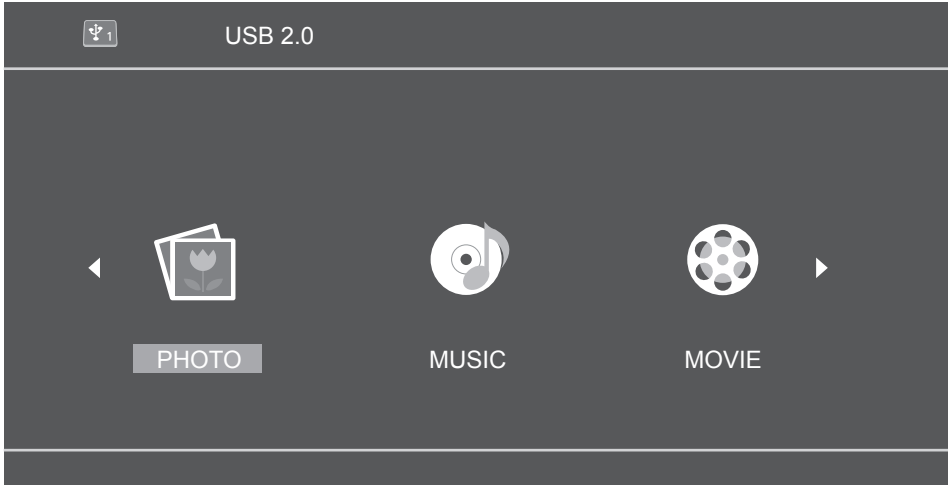

- 4 The USB flash drive will appear as "C" depending on the situation. Press the [OK] button of the remote control and open this C drive (media list page).
- 5 Use the up (▲) and the down (▼) buttons of the remote control to search contents in the USB flash drive. Press the [OK] button to open the contents you want to play.

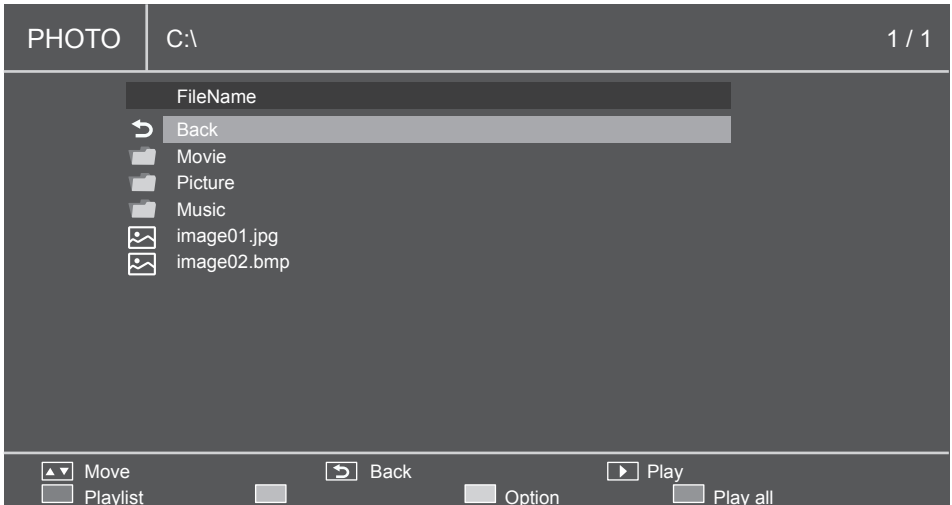

- 6 Playback the media files by using the media playback buttons (Rewind (<<)), Play (>), Forward (>>), Previous (<<<), Stop (□), Pause (⏸), Next (>>>)).
- 7 While the content files are played with this method, coloured buttons of the remote control will be enabled. Function of each button is decided with the mode of the media source, and it will be displayed at the bottom of the OSD menu of LCD display. Refer to "Remote control buttons when using the play guide" on page 36. Functions of menu buttons of LCD display will also change. The following table describes the function of each menu button when USB input is selected.

Functions of the menu buttons when USB input is selected			
Definition of keypad	Status of selection of USB input		
Key name	Media root page	Media list / play list mode	Media player mode
Menu	Input source key	End	End
Input	OK	In file: Play / Stop In folder: [OK] key In OSD's dialogue: [OK] key	Play / Stop
Increase the volume	Right key	Right key	Increase the volume
Decrease the volume	Left key	Left key	Decrease the volume
Up	Up key	Up key	Next image / music file / video
Down	Down key	Down key	Previous image / music file / video
Power supply	Power supply off	Power supply off	Power supply off

■ Supported devices

- Commercially available USB flash drives are supported. (USB flash drives with security function are not supported. Operation is not guaranteed.)
- You can only use USB flash drives that are formatted in FAT16 or FAT32.
- Maximum memory size of USB is 32 GB.
- Only USB flash drives with single partition configuration is supported.

Note

- Maximum size of one file is up to 2 GB.
- There are files that cannot be played even if such files are in the supported formats mentioned here.
- Files protected with digital copyright management (DRM) cannot be played.
- Make sure that both audio codec and video codec are supported. When the audio codec of a video file is in unsupported format, video may not be correctly displayed.
- When the number of pixels of the file exceeds the screen size, the image quality will change.

■ Set the playlist

- 1 Select one from the contents type menu ([PHOTO], [MUSIC], [MOVIE]).
- 2 The USB flash drive will appear as "C". Press the [OK] button of the remote control and open this C drive.

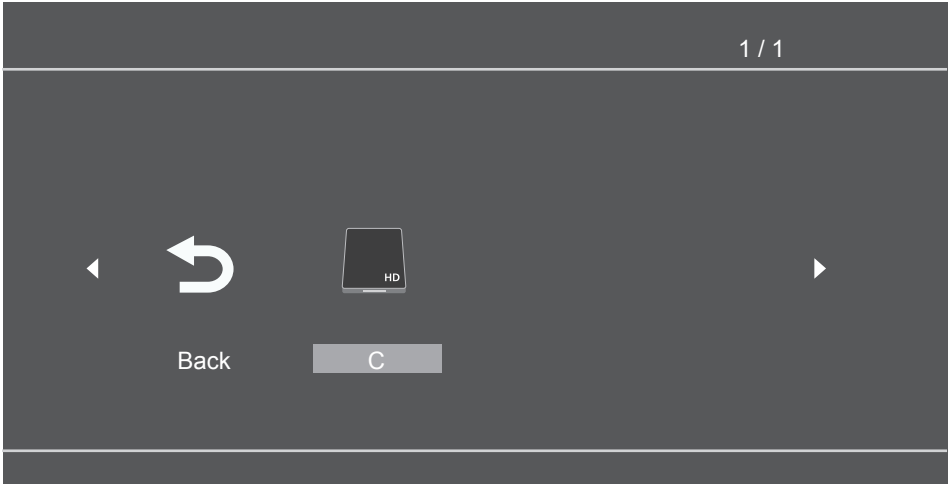

- 3 Pressing the red button will show the check boxes. Select files with the up (▲) and the down (▼) buttons and add the checked and selected files to the playlist with the [OK] button.

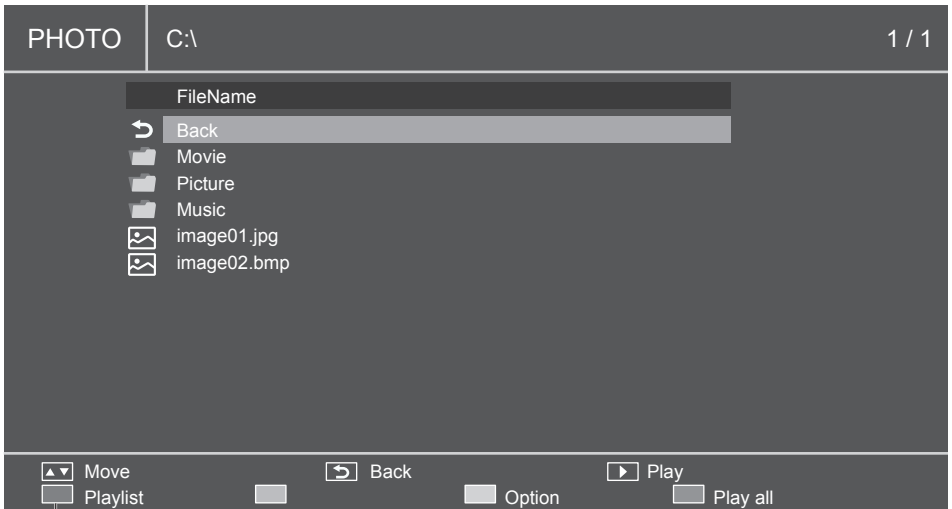

Red

4 Use the media operation buttons and select an option of the playlist menu.

- Red: Cancel and return to the previous menu.
- Green: Load the existing playlist.
- Yellow: Clear all files selected in the current playlist.
- Blue: Save the selected files in the playlist.



5 When the playlist is not defined, pressing either the red button (Play all), [OK] button, and Play button (▶) will play all files in the current folder.

Note

- Changing to another input source without saving the playlist will delete the playlist being prepared.

■ Play music in the background



With this icon, you can play music in the background. When music is also included in the folder where pictures are saved, you can play music in the background while pictures are displayed.

- 1 Display the play guide with the up (▲) button.

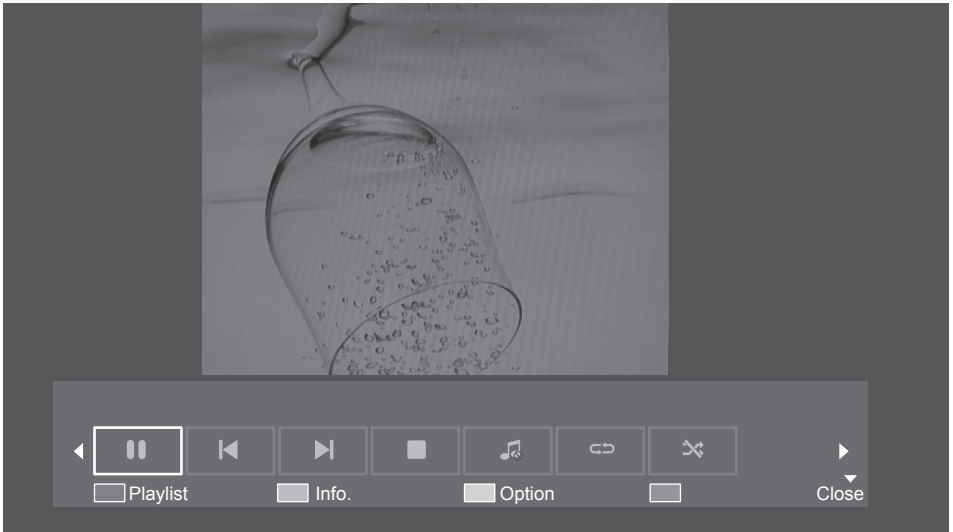

- 2 Use the left (◀) and the right (▶) buttons of the remote control and select icon for playing the music in the background. Press the [OK] button to confirm the selection.
- 3 When music is also included in the folder where pictures are saved, you can play music in the background while pictures are displayed.

■ Slideshow settings

In the playback mode of pictures, by using slideshow, you can play all selectable pictures (or all pictures in the playlist). Use the yellow button to display slideshow options.



- 1 **[Slideshow Time]:** It sets the waiting time until each image of slideshow is displayed.
 - You can set between 3 seconds - 20 seconds in the unit of 1 second.
- 2 **[Transition]:** It sets the type of transition of slideshow images.
 - [Off]
 - [Scroll left]
 - [Scroll right]
 - [Scroll up]
 - [Scroll down]
 - [Box in]
 - [Box out]

■ Play the playlist

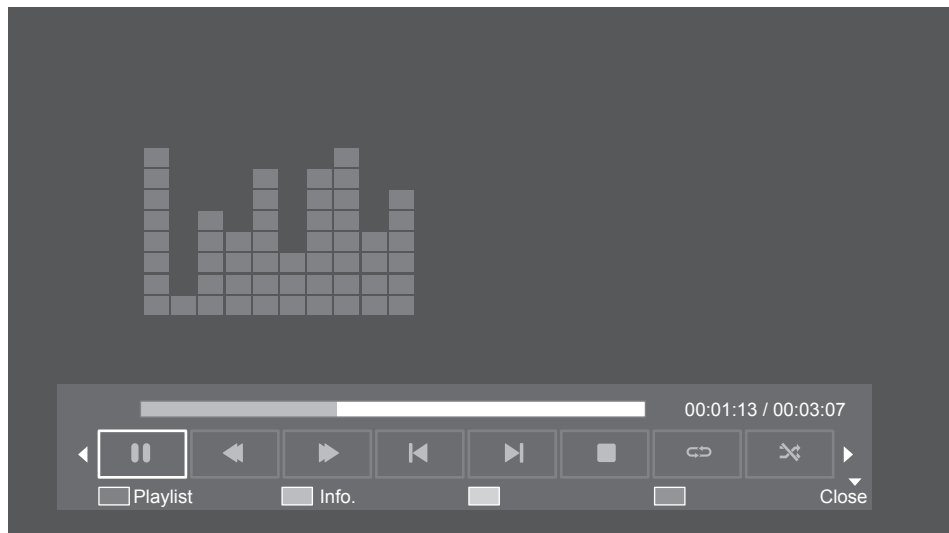





When the playlist is playing, you can use the play guide that offers additional functions. Use the up (▲) button to display the functions.

Use the left (◀) and the right (▶) buttons to select the functions.

Use the [OK] button to confirm the selection. Use the [Info.] button to hide the play guide.

Functions of play guide	
Remote key	Function
	Pause / Play
	Forward (Cannot be used in the [PHOTO] mode)
	Rewind (Cannot be used in the [PHOTO] mode)
	Next picture / track / file
	Previous picture / track / file
	Stop the playback
	Play / stop the music in the background (Can be used only in the [PHOTO] mode. When this function cannot be used, the button will not work even if you press it.)
	Repeat: All files will be repeatedly and continuously played.
	Shuffle: All files will be randomly played.

Remote control buttons when using the play guide

Remote control buttons	PHOTO	MUSIC	MOVIE
▲	Show the play guide	Show the play guide	Show the play guide
▼	Hide the play guide	Hide the play guide	Hide the play guide
◀▶	It is used for selecting menu items. (Play / Stop / Skip to above / Skip to below / Stop / Music / Repeat / Shuffle / Slideshow Time / Transition)	It is used for selecting menu items. (Stop or Play / Forward / Rewind / Skip to above / Skip to below / Repeat / Shuffle)	It is used for selecting menu items. (Stop or Play / Forward / Rewind / Skip to above / Skip to below / Repeat / Shuffle)
OK	It is used for selecting menu items. (Play / Stop / Skip to above / Skip to below / Stop / Music / Repeat / Shuffle / Slideshow Time / Transition)	It is used for selecting menu items. (Stop or Play / Forward / Rewind / Skip to above / Skip to below / Repeat / Information)	It is used for selecting menu items. (Stop or Play / Forward / Rewind / Skip to above / Skip to below / Repeat / Information)
▷	Play the item selected	Play the item selected	Play the item selected
□	Stop and return to the list screen	Stop and return to the list screen	Stop and return to the list screen
▢▢	Pause the slideshow	Pause the playback	Pause the playback
▷▷	Not used	Forward	Forward
◀◀	Not used	Rewind	Rewind
▷▷	Next picture	Next track	Next track
◀◀	Previous picture	Previous track	Previous track
Red 	[Playlist]: Show details of the playlist	[Playlist]: Show details of the playlist	[Playlist]: Show details of the playlist
Green 	[Info.]: Show details of the current file	[Info.]: Show details of the current file	[Info.]: Show details of the current file
Yellow 	[Option]: Options of slideshow	Not used	Not used
Blue 	[Play all]	[Play all]	[Play all]
INFO	Show / Hide the play guide	Show / Hide the play guide	Show / Hide the play guide
↶	Return to the list screen	Return to the list screen	Return to the list screen

Control by the serial terminal

1 Control by the serial terminal

From the [Setup] menu, set [Control Setting] to [SERIAL IN]. (see page 44)

RS-232C cable:

Connect a serial cross cable (reverse) to the SERIAL IN terminal (male).

Select the RS-232C cable for communication used for connecting SERIAL IN terminal and computer according to the computer you are using.

Use Rx/D, Tx/D, and GND cables for directly connecting with serial terminal.

You can control the display remotely by using this communication interface.

2 Communication conditions

Signal level: RS-232C compliant

Synchronization method: Asynchronous

Baud rate: 9600 bps

Parity: None

Character length: 8 bits

Snap bit: 1 bit

Flow control: None

Basic format

Transmission from the computer will start with STX followed by commands and parameters. In the end, ETX will be sent. Add parameters as required according to control details.

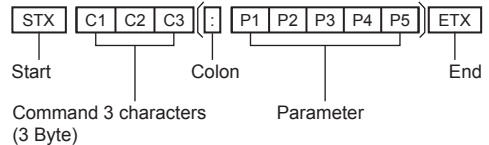

3 List of commands

Command	Parameter	Control details
PON	None	Power ON
POF	None	Power OFF
AVL	***	Volume 000 – 100
AMT	0	Mute Off
	1	Mute On
IMS	None	Input select (toggle)
	HM1	HDMI 1 input (HDMI1)
	HM2	HDMI 2 input (HDMI2)
	DV1	DVI-D IN input (DVI-D)
	PC1	PC IN input (PC)
	UD1	USB input (USB)
VMT	0	Video mute (including OSD) Off
	1	Video mute (including OSD) On

Note

- When sending multiple commands, make sure to send the next command only after receiving response from the device. Colon (:) is not required when sending a command that doesn't require any parameter.
- Sending an incorrect command will result in the transmission of a command called "ER401" from the device to the computer.
- During the power supply "Standby" state (power supply "Off" in the remote control), working of commands other than the "PON" command is not guaranteed.
- Please contact your dealer for the details of commands. Or, refer to the following support website.
<https://panasonic.net/cns/prodisplays/>

Configuration and basic operation of OSD screen

In this device, the OSD (on-screen display) function has been used so that the settings can be easily adjusted. With the OSD function, you can operate the menu displayed on the screen and adjust brightness and other settings.

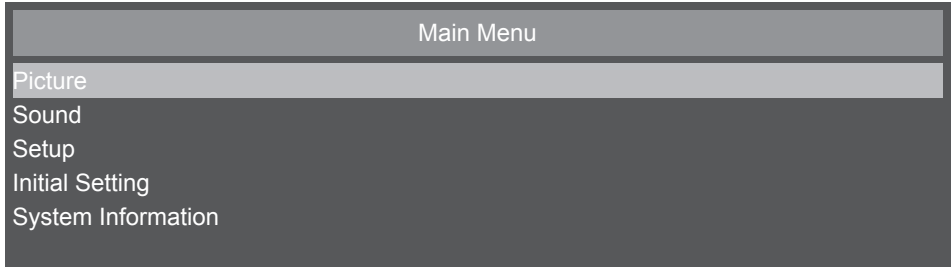









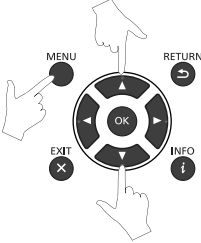

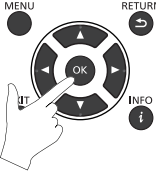
This table shows the functions of default settings of OSD of the Main Menu screen. Detailed items are explained from next page onwards.

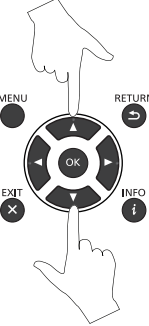
Main Menu screen	
Menu items	Detailed information
[Picture]	See page 41
[Sound]	See page 43
[Setup]	See page 44
[Initial Setting]	See page 45
[System Information]	See page 47

■ Basic operation of OSD screen

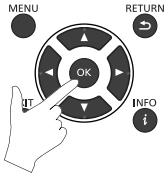
Check that the power indicator has light up in green colour and power supply of the device is on.

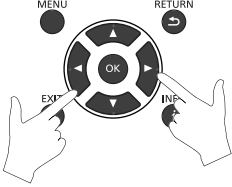
Step	Remote control	Buttons of the monitor
1	 <p>Press the [MENU] button to display the OSD screen. Use the up (▲) / down (▼) buttons and select items from the [Main Menu].</p>	
2	 <p>Pressing the [OK] button and confirming the selected [Main Menu] will select the sub menu located at the top.</p>	 <p>Pressing the [INPUT] button and confirming the selected [Main Menu] will select the sub menu located at the top.</p>
3	 <p>Use the up (▲) / down (▼) buttons to select a sub menu.</p>	

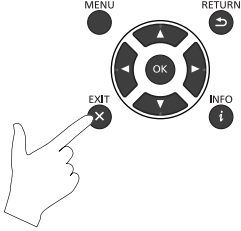
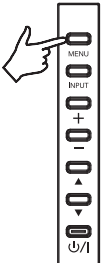
Step	Remote control	Buttons of the monitor
4	 <p>Press the [OK] button and confirm the selected sub menu.</p>	 <p>Press the [INPUT] button and confirm the selected sub menu.</p>
5	 <p>Use the left (◀) and the right (▶) buttons to select the settings.</p>	 <p>Use the plus (+) and the minus (-) buttons to select the settings.</p>
6	 <p>Press the [EXIT] button to close the current menu.</p>	 <p>Press the [MENU] button to close the current menu.</p>

■ Menu screen of picture

You can adjust picture quality by either selecting [Picture] in the [Main Menu] and pressing the [OK] button of the remote control, or by displaying the [Picture] menu with the [PICTURE] button of the remote control.

Picture	
Picture Mode	Dynamic
Backlight	100
Color Temperature	11500
Gamma	2.2
Noise Reduction	Middle
Adaptive Contrast	Off
Over Scan	Off
Aspect Ratio	16:9
Color Range	Automatic
PC setting	
Reset Picture Setting	

Menu screen of picture	
[Picture Mode]	<p>You can go to the [Picture Mode] menu by using the [OK] button of the remote control and you can change to the following modes.</p> <p>[Picture Style]: You can select the mode that is suitable to the image to be displayed.</p> <p>[Dynamic]: Brightness will become maximum.</p> <p>[Cinema]: It is suitable for playback of cinema contents.</p> <p>[Custom]: It will use the custom image settings saved earlier ([Standard] settings are used in the default mode). You can set a custom mode in [Picture Mode] - [Custom] of the OSD menu screen.</p> <p>[Standard]: It is the standard image quality.</p> <ul style="list-style-type: none"> • [Cinema] will be available for selection according to the input signal. <p>You can make the following settings to determine the picture style.</p> <p>[Contrast]: Adjusts the difference between light and dark of images.</p> <p>[Brightness]: Adjusts light and dark of the entire screen.</p> <p>[Sharpness]: Adjust the sharpness of image outlines.</p> <p>[Tint]: Adjust the tint of entire images.</p> <p>The hues of red, green, blue, yellow, cyan and magenta can be respectively set.</p> <p>[Color]: Adjusts the colour of images.</p> <p>The saturations of red, green, blue, yellow, cyan and magenta can be respectively set.</p> <p>Adjusting these will store the values as [Picture Style: Custom].</p> <ul style="list-style-type: none"> • Depending on input images, changes occurring by adjusting these settings may be small.
[Backlight]	Adjusts the settings of back light.
[Color Temperature]	Adjusts colour temperature and gain.
[Gamma]	Selects the settings of gamma.
[Noise Reduction]	It adjusts the extent of reducing noise.
[Adaptive Contrast]	It turns on / off the function of automatically adjusting the contrast after determining how to use the colours.
[Over Scan]	Adjusts the settings of over scan. (It will not work in PC input.)

[Aspect Ratio]	It adjusts the settings of aspect ratio. • For details of the settings, refer to “Menu settings of aspect ratio” below.
[Color Range]	You can adjust the settings of colour range, or set it to [Automatic]. For digital video source input, it changes the dynamic range according to the input signal.
[PC setting]	It adjusts horizontal and vertical position, clock, and phase. (It will work only in PC input.)
[Reset Picture Setting]	Settings will be restored to the factory default settings.

■ Menu settings of aspect ratio

Picture	
Picture Mode	Dynamic
Backlight	100
Color Temperature	11500
Gamma	2.2
Noise Reduction	Middle
Adaptive Contrast	Off
Over Scan	Off
Aspect Ratio	◀ 16:9 ▶
Color Range	Automatic
PC setting	
Reset Picture Setting	

Menu settings of aspect ratio		
Input source	[Over Scan]	[Aspect Ratio]
HDMI1 / HDMI2 DVI-D PC	[Off]	[4:3] [16:9] [Dot By Dot]
	[Auto]	[4:3] [16:9] [Zoom] [Cinema] [Dot By Dot]
Media video	[Off]	[4:3] [16:9]
	[Auto]	[4:3] [16:9] [Zoom]

■ Menu screen of sound

You can adjust sound by either selecting [Sound] in the [Main Menu] and pressing the [OK] button of the remote control, or by displaying the [Sound] menu with the [SOUND] button of the remote control.

Sound	
Sound Mode	Dynamic
Surround Sound	Off
Output Select	EXT SP
Audio Source	HDMI1
Reset Audio Setting	

Menu screen of sound	
[Sound Mode]	<p>You can go to the [Sound Mode] menu by using the [OK] button of the remote control and you can change to the following modes.</p> <p>[Sound Style]: You can select the mode that is suitable to the audio.</p> <p>[Standard]: Factory default setting</p> <p>[Dynamic]: Setting for emphasizing audio</p> <p>[Custom]: Use the custom audio settings saved earlier</p> <p>You can adjust high volume, low volume, and balance that decide the audio style. Adjusting this will store the value as [Sound Style: Custom].</p>
[Surround Sound]	Turns on / off the surround sound.
[Output Select]	<p>[EXT SP]: Audio will be output from the speaker connected to the EXT SP terminal.</p> <p>[AUDIO OUT]: LINE OUT signal of audio will be output from the AUDIO OUT terminal.</p>
[Audio Source]	Either [AUDIO IN / HDMI1] or [AUDIO IN / HDMI2] is selected as the audio source.
[Reset Audio Setting]	Settings will be restored to the factory default settings.

■ Menu screen of settings

Setup	
Scheduler	Off
Signal Check Priority	
Control Setting	OFF
Sleep Timer	Off
No Activity Power Off	Disable
Power On Message	On
Initial Startup	Last Memory
Power Management Setting	300 Sec
EDID	1.4
Software Update(USB)	
Restore Default	

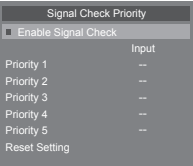
Menu screen of settings	
[Scheduler]	Changes the settings of the scheduler.
[Signal Check Priority]	<p>Sets priority of the signal between 1 and 5 ([Priority 1] is the highest). When the existing source signal is lost, the display will search for a new signal source according to the signal check priority.</p> <ul style="list-style-type: none"> • When [Signal Check Priority] is enabled, the display will search for an enabled signal source according to the settings of signal check priority when the power supply is turned on. • When there is no signal source of [Priority 1], the display will check other sources in the higher order of priority and it will appropriately change the source. • When the highest priority signal source is restored, the display will automatically changeover to this source once again. • When [Signal Check Priority] is disabled, the display will use the source used last when the power supply is turned on. • When [Signal Check Priority] is enabled, the system will automatically play USB if the source was USB when the power supply was on.
	
[Control Setting]	Select so that the LCD display is controlled via the serial terminal.
[Sleep Timer]	Changes the settings of sleep timer, or turns off the sleep timer.
[No Activity Power Off]	Enables / disables the function of automatic standby when the device is not operated for about 4 hours or more.
[Power On Message]	<p>You can show / hide the startup message display when [No Activity Power Off] is enabled.</p> <ul style="list-style-type: none"> • You cannot set this if [No Activity Power Off] is [Disable].
[Initial Startup]	[Last Memory], [Standby], [On]
[Power Management Setting]	Changes the settings of power management, or turns off the power management mode.
[EDID]	<p>Setting the EDID version to suit for video equipment will enhance the compatibility between this unit and video equipment.</p> <p>[2.0]: Enhances the compatibility to the equipment that can output images of resolution higher than 1 920 x 1 200.</p> <p>[1.4] (Default setting): Enhances the compatibility to the equipment that can output images of resolution 1 920 x 1 200 or less.</p> <ul style="list-style-type: none"> • When no image is output from video output devices (PC, DVD player, etc.), switching the setting of EDID.
[Software Update(USB)]	Updates the software via the USB terminal (for service).
[Restore Default]	Settings will be restored to the factory default settings.

■ Menu screen of initial settings

Initial Setting	
OSD Rotation	◀ Landscape ▶
Menu Language	English
Clock	2017/1/5 05:04
Logo Display	Enable
Remote Operation	Enable
Keypad Operation	Enable

Menu screen of initial settings	
[OSD Rotation]	Selects either [Portrait] or [Landscape] as the direction of OSD.
[Menu Language]	Select the language of OSD menu.
[Clock]	Changes time and date.
[Logo Display]	Selects whether to display the logo of Panasonic or not when the power supply is turned on.
[Remote Operation]	Enables / disables the operation of the remote control. Note: When the remote control operation is disabled, you can enable the operation of remote control by pressing the buttons of the remote control in the [MENU] / left / right / up / down sequence. If [Keypad Operation] was set to [Disable], it will also be set to [Enable] in this case.
[Keypad Operation]	Enables / disables the control button operation of the unit.

■ Setting method of the scheduler

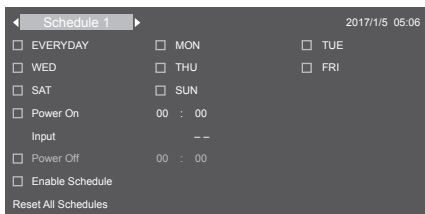
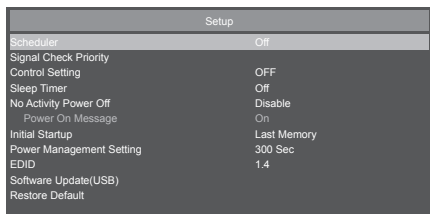

Selecting a programme number

When the cursor is inside the box that shows programme number 1 through 7 on the top left of the screen, you can select the target programme number by using the left (◀) / right (▶) buttons. You can select from [Schedule 1] through [Schedule 7].

For enabling the selected programme number, press the [OK] button in the [Enable Schedule] check box and put the check mark. For disabling a number, uncheck [Enable Schedule] check box.

Set the scheduler of each programme

You can make the following settings in the scheduler

You can move each item by using cursor buttons.

You can select items by pressing the [OK] button and by checking the check box. You can deselect by removing check mark from the check box.

For the power supply on / off time items, you can set time with the up and down buttons by selecting places from the time display and pressing the [OK] button. For closing a time setting, press the [RETURN] (↵) button.

For input items, you can press the left and right buttons and select the input source.

Scheduler settings	
Settings	Setting details
[Schedule 1] - [Schedule 7]	You can select and programme up to 7 schedules.
[EVERYDAY]	Selecting this item will run the schedule everyday.
[MON] - [SUN]	Selects days of the week on which you want to run the schedule.
[Power On]	Sets the time when the power supply will turn on.
[Input]	Select the target audio video input source.
[Power Off]	Sets the time when the power supply will turn off (standby mode). When you do not want to set the schedule of power supply off, do not check this item.
[Enable Schedule]	It enables / disables the current schedule.
[Reset All Schedules]	All schedules will be reset to factory default settings (no schedule).

Checking schedules

For checking schedules, press the [MENU] button located the remote control or the left side of LCD display, and display the [Scheduler] menu from the OSD menu screen.

Turning off the power supply before closing the [Scheduler] menu may cancel the scheduler settings.

Note

- Before setting a schedule, make sure to check the current date and time by using [Clock].
- Settings will be saved when the scheduler screen is closed.
- When two or more schedules are enabled, these schedules will run in accordance with the timer settings. When time range is overlapping between individual schedules, changing power supply off time to that of the schedule starting afterwards and closing the schedule executed in the end will turn off the power supply.
- When power supply on / off time of two or more schedules is same, power supply on / off time of the youngest programme number will be executed.
- Once a schedule is set, off timer will be disabled.
- Power supply on time and power supply off time cannot be set to the same time.
- Power supply off time cannot be set unless power supply on time is set.
- Even if the main power supply is turned off or the breaker has tripped because of power outage or other reasons, programme of the scheduler will be saved and it will run once the main power supply turns on. However, if the main power supply remains off for 168 hours (7 days) or more, system time will no longer remain accurate.

■ Menu screen of system information

System Information	
Model Name	TH-75BQE1
SW Version	1.00.00
Serial Number	-----

Menu screen of system information	
[Model Name]	Shows item number of the product.
[SW Version]	Shows the current version of software of the display.
[Serial Number]	Shows the serial number of the device.

Annex

■ **Table 1: Specifications of the supported formats (video)**

File extension	Container	Video codec	Maximum resolution	Maximum frame rate	Maximum bit rate	MPEG1 Audio Layer3 (MP3)	AC3	AAC HE-AAC	WMA	L-PCM
.ts .trp .to .m2ts	MPEG2-TS	H.264	1 080P	30 fps	20 Mbps	○	○	○		
.mp4	MP4	MPEG-4 AVC/ H.264	1 080P	30 fps	20 Mbps	○		○		
.mkv	MKV	H.264	1 080P	30 fps	20 Mbps	○	○	○		○
		MPEG-4 AVC	1 080P	30 fps	20 Mbps					
.avi	AVI	MPEG-4 AVC	1 080P	30 fps	20 Mbps	○	○	○		○
		H.264	1 080P	30 fps	20 Mbps					
.asf .wmv	ASF	MPEG-4 AVC	1 080P	30 fps	20 Mbps	○	○		○	○
		VC1	1 080P	30 fps	20 Mbps					
		WMV3	1 080P	30 fps	20 Mbps					

* The device may not be able to play some of the video files. Especially, the device may not be able to play MP4 video files depending on the encoder.

■ **Table 2: Specifications of the supported formats (audio)**

File extension	Audio codec	Bit rate	Sampling rate
.mp3	MPEG1 Audio Layer 3	32 Kbps - 320 Kbps	32 kHz - 48 kHz
N/A (Only video files are supported)	AC3	32 Kbps - 640 Kbps	32 kHz, 44.1 kHz, 48 kHz
.m4a .AAC	AAC, HEAAC	24 Kbps - 384 Kbps	8 kHz - 48 kHz
.wma .asf	WMA	128 Kbps - 320 Kbps	8 kHz - 48 kHz
N/A (Only video files are supported)	LPCM	64 Kbps - 1.5 Mbps	8 kHz - 48 kHz

■ **Table 3: Specifications of the supported formats (picture)**

File extension	Codec (Format)	Picture	Resolution
.jpg	JPEG	Baseline	15 360 x 8 640
		Progressive	1 024 x 768
.png	PNG	Non-interlaced	9 600 x 6 400
		Interlaced	1 200 x 800
.bmp	BMP	-	9 600 x 6 400

The device may not be able to play some pictures even if the container and codec are as described.

■ Table 4: Preset signal

Supported signals	Resolution (dots)	Scanning frequency		Dots Clock frequency (MHz)	Input		
		Horizontal (kHz)	Vertical (Hz)		PC	DVI-D	HDMI1 HDMI2
640 x 480 60Hz	640 x 480	31.47	59.94	25.18	○	○	○
640 x 480 75Hz	640 x 480	37.50	75.00	31.50	○	○	○
800 x 600 60Hz	800 x 600	37.88	60.32	40.00	○	○	○
800 x 600 72Hz	800 x 600	48.08	72.19	50.00	○	○	○
800 x 600 75Hz	800 x 600	46.88	75.00	49.50	○	○	○
1024 x 768 60Hz	1 024 x 768	48.36	60.00	65.00	○	○	○
1024 x 768 70Hz	1 024 x 768	56.48	70.07	75.00	○	○	○
1024 x 768 75Hz	1 024 x 768	60.02	75.03	78.75	○	○	○
1280 x 768 60Hz	1 280 x 768	47.40	59.99	68.25	○	○	○
1280 x 768 60Hz	1 280 x 768	47.78	59.87	79.50	○	○	○
1280 x 960 60Hz	1 280 x 960	60.00	60.00	108.00	○	○	○
1280 x 1024 60Hz	1 280 x 1 024	63.98	60.02	108.00	○	○	○
1360 x 768 60Hz	1 360 x 768	47.71	60.02	85.50	○	○	○
1600 x 1200 60Hz	1 600 x 1 200	75.00	60.00	162.00	○	○	○
1366 x 768 60Hz	1 366 x 768	47.71	59.70	85.50	○	○	○
1920 x 1080 60Hz	1 920 x 1 080	67.50	60.00	148.50	○		
1280 x 800 60Hz	1 280 x 800	49.70	59.81	83.50	○	○	○
640 x 480 60Hz	640 x 480	31.50	60.00	25.20		○	○
480p 60Hz	720 x 480	31.50	60.00	27.03		○	○
480p 60Hz	720 x 480	31.50	60.00	27.03		○	○
720p 60Hz	1 280 x 720	45.00	60.00	74.25		○	○
1080i 60Hz	1 920 x 540	33.75	60.00	74.25		○	○
480i 60Hz	720(1 440) x 480i	15.75	60.00	27.03			○
1080p 60Hz	1 920 x 1 080	67.50	60.00	148.50		○	○
576p 50Hz	720 x 576	31.25	50.00	27.00		○	○
576p 50Hz	720 x 576	31.25	50.00	27.00		○	○
720p 50Hz	1 280 x 720	37.50	50.00	74.25		○	○
1080i 50Hz	1 920 x 540	28.13	50.00	74.25		○	○
576i 50Hz	720(1 440) x 576i	15.63	50.00	27.00			○
1080p 24Hz	1 920 x 1 080	27.00	24.00	74.25		○	○
1080p 25Hz	1 920 x 1 080	28.13	25.00	74.25		○	○
1080p 30Hz	1 920 x 1 080	33.75	30.00	74.25			○
2160p 24Hz	3 840 x 2 160	54.00	24.00	297.00			○
2160p 25Hz	3 840 x 2 160	56.25	25.00	297.00			○
2160p 30Hz	3 840 x 2 160	67.50	30.00	297.00			○
2160p 50Hz	3 840 x 2 160	112.50	50.00	594.00			○
2160p 60Hz	3 840 x 2 160	135.00	60.00	594.00			○
4096 x 2160 24Hz	4 096 x 2 160	54.00	24.00	297.00			○
4096 x 2160 25Hz	4 096 x 2 160	56.25	25.00	297.00			○
4096 x 2160 30Hz	4 096 x 2 160	67.50	30.00	297.00			○
4096 x 2160 50Hz	4 096 x 2 160	112.50	50.00	594.00			○
4096 x 2160 60Hz	4 096 x 2 160	135.00	60.00	594.00			○

Troubleshooting

Check the following points once again.

Symptom	Check	Page
Some pixels on the screen do not light up.	<ul style="list-style-type: none"> LCD panels are made with very high precision technology. However, there may be missing pixels or bright spots in some parts of the screen, but this is not a malfunction. 	-
Power supply doesn't start.	<ul style="list-style-type: none"> Check if the power supply plug or the connector is removed from the power socket or the device. 	20
Power automatically turns off unexpectedly.	<ul style="list-style-type: none"> Check the settings of [Sleep Timer], [Power Management Setting] and [No Activity Power Off]. Any of them may be set to [On (Enable)]. 	27
Power indicator is blinding in red	<ul style="list-style-type: none"> There is a possibility of malfunction. Please contact your dealer. 	-
No remote control operations can be performed.	<ul style="list-style-type: none"> Check whether the batteries have discharged completely and, if they have not, whether they were inserted properly. Check whether the remote control sensor is exposed to an outdoor light or a strong fluorescent light. Check whether any obstacle is present between the remote control sensor and the remote control. 	- -
	<p>If the installation condition is normal, pull out the remote control sensor from the edge side of the main unit when using.</p> <ul style="list-style-type: none"> Check whether the remote control designed specifically for use with the unit is being used. (The unit cannot be operated by any other remote control.) Check if [Initial Setting] - [Remote Operation] is set to [Disable]. 	19 -
	<ul style="list-style-type: none"> The unit digitally processes the various signals in order to reproduce esthetically pleasing images. As such, it sometimes takes a few moments for the picture to appear when the power has been turned on, or when the input has been switched. 	45 -
It takes a while for the picture to appear.	<ul style="list-style-type: none"> The unit digitally processes the various signals in order to reproduce esthetically pleasing images. As such, it sometimes takes a few moments for the picture to appear when the power has been turned on, or when the input has been switched. 	-
Spots appear on the screen.	<ul style="list-style-type: none"> This may occur because of interference from automobiles, trains, high voltage lines, neon lights, etc. 	-
Colour is pale.	<ul style="list-style-type: none"> Check if the colour strength is adjusted properly. (Check the adjusted values of the picture.) 	41
Coloured pattern appears and then the colour fades.	<ul style="list-style-type: none"> Check if the unit is affected (interference) by another imaging device. This symptom may improve if the installation location of the unit is changed. 	-
The top or bottom of the picture on the screen is cut off.	<ul style="list-style-type: none"> The image position has been adjusted. Adjust the position of the picture on the screen. 	42
There are areas at the top and bottom of the screen where picture is not displayed.	<ul style="list-style-type: none"> When using a video software programme (such as a cinema size programme) with a screen wider than one in the 16:9 mode, blank areas separate from the images are formed at the top and bottom of the screen. 	-
The edges of the images flicker.	<ul style="list-style-type: none"> Due to the characteristics of the system used to drive the liquid crystal panel, the edges may appear to flicker in the fast-moving parts of the images. This is normal and not indicative of malfunctioning. 	-
The unit cannot be operated with the buttons provided in the unit.	<ul style="list-style-type: none"> Check if [Keypad Operation] is set to [Disable]. 	45
There is no picture displayed or sound output sometimes.	<ul style="list-style-type: none"> When HDMI or DVI signals are input to the display using a selector or distributor, sound or images may not be output in the normal fashion depending on the selector or distributor used. <p>The symptoms may be improved by turning the power off and on again, or by replacing the selector or distributor.</p>	-
Display is strange such as no picture, or the remote control stopped working suddenly.	<ul style="list-style-type: none"> Very advanced software is embedded in the unit. If you feel something is strange, for example "The remote control cannot be operated" or "The display is corrupted", remove the power supply plug from the power socket and insert the power supply plug once again after about 5 seconds and start the power supply. 	26
Serial control doesn't work.	<ul style="list-style-type: none"> Check if the connection is correct. 	37

Specifications

Main unit

Model No.	TH-75BQE1W
Type	Touch screen LCD display
Power source	110 – 240 V ~ (110 – 240 V alternating current), 50/60 Hz
Power consumption	370 W
	Power off with the Main power switch: approx. 0 W Power off with the remote control: approx. 0.5 W
LCD display panel	VA panel (Direct LED backlight)
	75-inch model (16:9 aspect ratio)
Screen size	1 650 mm (W) × 928 mm (H) × 1 893 mm (diagonal) / 64.9" (W) × 36.5" (H) × 74.5" (diagonal)
Number of pixels	8 294 400 pixels (3 840 (horizontal) × 2 160 (vertical))
Operating condition	Temperature: 0 °C – 40 °C (32 °F – 104 °F)*1 Humidity: 20 % – 80 % (no condensation)
Storing condition	Temperature: -20 °C – 60 °C (-4 °F – 140 °F) Humidity: 20 % – 80 % (no condensation)
HDMI input terminal HDMI 1 / HDMI 2	TYPE A Connector*2 × 2 Audio signal: Linear PCM (sampling frequencies - 48 kHz, 44.1 kHz, 32 kHz)
Digital RGB input terminal DVI-D IN	DVI-D 24 Pin × 1
PC input terminal PC IN	Mini D-sub 15 Pin (Compatible with DDC2B) × 1
	R/G/B 0.7 Vp-p (75 Ω) (without sync signal) HD/VD TTL
Audio input terminal AUDIO IN	Stereo mini jack (M3) × 1, 0.5 Vrms, shared with DVI-D IN and PC IN
Audio output terminal AUDIO OUT	Stereo mini jack (M3) × 1, 0.5 Vrms Output: Variable (-∞ – 0 dB) (1 kHz 0 dB input, 10 kΩ load)
Serial input terminal SERIAL IN	External Control Terminal
	D-sub 9 Pin × 1 RS-232C compatible
External speaker terminal EXT SP	8Ω, 20 W [10 W + 10 W] (10 % THD)
IR input terminal IR IN	Stereo mini jack (M3) × 1
USB flash drive terminal USB	TYPE A USB connector × 1 DC 5V / 1A (USB 3.0 is not supported.)
Outer dimensions (W × H × D)	1 710 mm × 989 mm × 102 mm / 67.3" × 39.0" × 4.02"
	1 710 mm × 1 072 mm × 102 mm / 67.3" × 42.3" × 4.02" (horizontal installation / when the speaker mounted) 989 mm × 1 793 mm × 102 mm / 39.0" × 70.6" × 4.02" (vertical installation / when the speaker mounted)
Mass	Approx. 66.0 kg / 145.5 lbs (Approx. 68.0 kg / 150.0 lbs when the speaker mounted.)
Cabinet material	Front: metal / Back cover: metal

Remote control

Power source	DC 3 V (battery (AA/R6/LR6 type) × 2)
Operating range	Approx. 5 m (from the front of the remote control sensor)
Mass	Approx. 113 g / 0.3 lbs (including batteries)
Outer dimensions (W × H × D)	160 mm × 50 mm × 20 mm / 6.3" × 2.0" × 0.8"

Speaker

Impedance	8 Ω
Rated input	20 W [10 W + 10 W]
Outer dimensions (W × H × D)	763 mm × 82 mm × 59 mm / 30.1" × 3.3" × 2.4"
Mass	Approx. 2.0 kg / 4.4 lbs
Cabinet material	Resin

*1 Environmental temperature to use this unit at high altitudes (1 400 m (4 593 ft) and higher and below 2 800 m (9 186 ft) above sea level); 0 °C to 35 °C (32 °F to 95 °F)

*2 VIERA LINK is not supported.

Disposal of Old Equipment and Batteries

Only for European Union and countries with recycling systems



These symbols on the products, packaging, and/or accompanying documents mean that used electrical and electronic products and batteries must not be mixed with general household waste. For proper treatment, recovery and recycling of old products and used batteries, please take them to applicable collection points in accordance with your national legislation. By disposing of them correctly, you will help to save valuable resources and prevent any potential negative effects on human health and the environment. For more information about collection and recycling, please contact your local municipality. Penalties may be applicable for incorrect disposal of this waste, in accordance with national legislation.



Note for the battery symbol (bottom symbol)

This symbol might be used in combination with a chemical symbol. In this case it complies with the requirement set by the Directive for the chemical involved.

Information on Disposal in other Countries outside the European Union

These symbols are only valid in the European Union.

If you wish to discard these items, please contact your local authorities or dealer and ask for the correct method of disposal.

Notice (U.S.A. only)

Disposal may be regulated in your community due to environmental considerations. For disposal or recycling information, please visit Panasonic website:

<http://www.panasonic.com/environmental>

or call 1-888-769-0149.

Customer's Record

The model number and serial number of this product may be found on its rear panel. You should note this serial number in the space provided below and retain this book, plus your purchase receipt, as a permanent record of your purchase to aid in identification in the event of theft or loss, and for Warranty Service purposes.

Model Number

Serial Number

Panasonic System Solutions Company of North America

Unit of Panasonic Corporation of North America

Executive Office :

Two Riverfront Plaza, Newark, New Jersey 07102

Panasonic Canada Inc.

5770 Ambler Drive

Mississauga, Ontario

L4W 2T3

Panasonic Testing Centre

Panasonic Service Europe, a division of Panasonic Marketing Europe GmbH

Winsbergring 15, 22525 Hamburg, F.R. Germany

Panasonic Corporation

Web Site: <http://panasonic.com>

English

DA0717TS1068 -PB