

**datavideo**

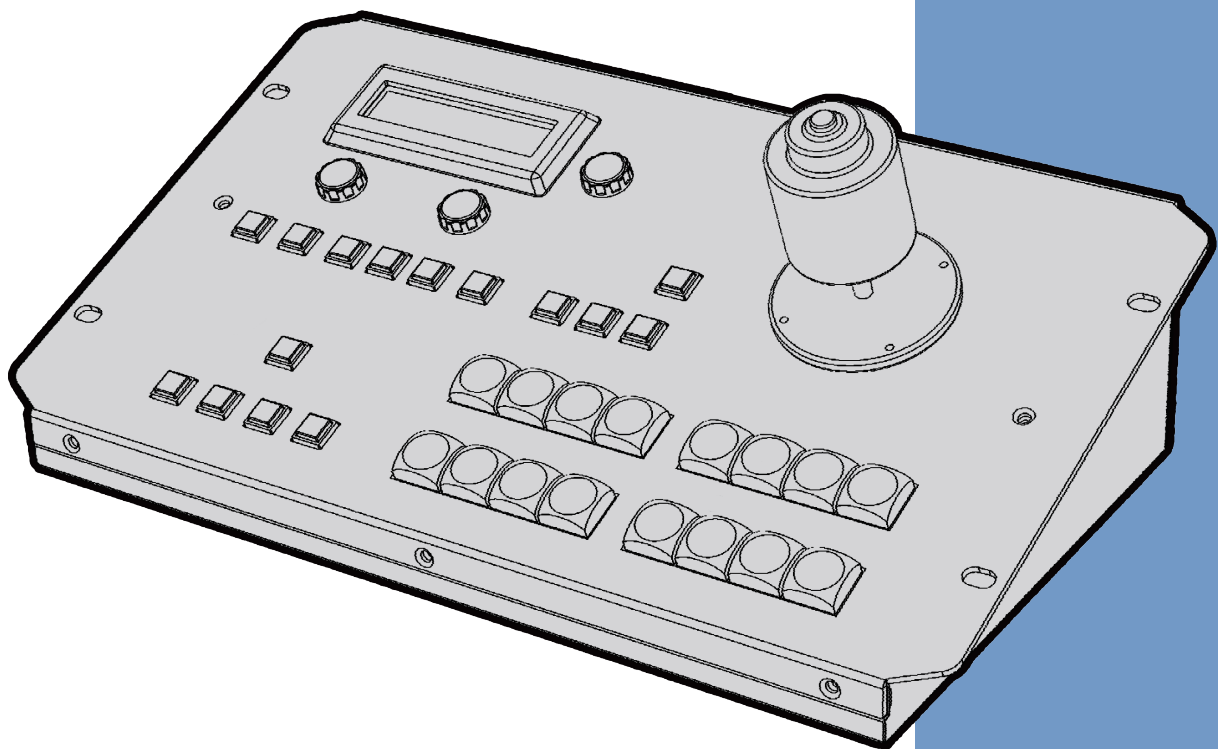

**KMU CONTROLLER  
RMC-185**  
**Instruction manual**

[www.datavideo.com](http://www.datavideo.com)

# Table of Contents

<b>FCC COMPLIANCE STATEMENT</b> .....	<b>4</b>
<b>WARNINGS AND PRECAUTIONS</b> .....	<b>4</b>
<b>WARRANTY</b> .....	<b>5</b>
STANDARD WARRANTY.....	5
THREE YEAR WARRANTY .....	5
<b>DISPOSAL</b> .....	<b>5</b>
<b>1. INTRODUCTION</b> .....	<b>6</b>
1.1 FEATURES .....	6
1.2 DEVICE SETUP .....	6
<b>2. CONNECTIONS AND CONTROLS</b> .....	<b>8</b>
2.1 FRONT PANEL – KEYBOARD .....	8
2.2 REAR PANEL - CONNECTIONS.....	12
<b>3. MENU SETUP</b> .....	<b>13</b>
FN1. EXITS THE MENU (EXIT).....	14
FN2. INPUT A SOURCE ASSIGNMENT (INPUT A SOURCE) .....	14
FN3. INPUT B SOURCE ASSIGNMENT (INPUT B SOURCE).....	14
FN4. OUTPUT FORMAT SELECTION (OUTPUT FORMAT) .....	14
FN5. AUDIO OUTPUT.....	15
FN6. GENLOCK SETTING (GENLOCK SET).....	15
FN7. GENLOCK STATUS DISPLAY (GENLOCK STATUS) .....	15
FN8. SELECTION OF SDI 3G TYPE (SDI 3G TYPE).....	15
FN9. OUTPUT ASSIGN.....	15
FN10. LIMIT.....	15
FN11. EXTERNAL MOTION TRIGGER SETTING (TRIGGER SET).....	15
FN12. KMU-100+ FIRMWARE VERSION DISPLAY (KMU-100+ VER.) .....	15
FN13. DISPLAY OF KMU-100+ FPGA AND PCB BOARD TEMPERATURES (KMU-100+ TEMP).....	15
FN14. RMC-185+ FIRMWARE VERSION DISPLAY (FIRMWARE VER.) .....	15
<b>4. STORING DIFFERENT DEVICE SETTINGS</b> .....	<b>16</b>
<b>5. FRAME MOTION CONFIGURATION</b> .....	<b>17</b>
<b>6. FIRMWARE UPGRADE PROCEDURE</b> .....	<b>19</b>
<b>7. FREQUENTLY-ASKED QUESTIONS</b> .....	<b>22</b>
<b>8. DIMENSIONS</b> .....	<b>23</b>
<b>9. SPECIFICATIONS</b> .....	<b>23</b>
<b>SERVICE AND SUPPORT</b> .....	<b>24</b>

## Disclaimer of Product and Services

The information offered in this instruction manual is intended as a guide only. At all times, Datavideo Technologies will try to give correct, complete and suitable information. However, Datavideo Technologies cannot exclude that some information in this manual, from time to time, may not be correct or may be incomplete. This manual may contain

typing errors, omissions or incorrect information. Datavideo Technologies always recommend that you double check the information in this document for accuracy before making any purchase decision or using the product. Datavideo Technologies is not responsible for any omissions or errors, or for any subsequent loss or damage caused by using the information contained within this manual. Further advice on the content of this manual or on the product can be obtained by contacting your local Datavideo Office or dealer.



## FCC Compliance Statement

This device complies with part 15 of the FCC rules. Operation is subject to the following two conditions:

1. This device may not cause harmful interference, and
2. This device must accept any interference received, including interference that may cause undesired operation.

## Warnings and Precautions



1. Read all of these warnings and save them for later reference.
2. Follow all warnings and instructions marked on this unit.
3. Unplug this unit from the wall outlet before cleaning. Do not use liquid or aerosol cleaners. Use a damp cloth for cleaning.
4. Do not use this unit in or near water.
5. Do not place this unit on an unstable cart, stand, or table. The unit may fall, causing serious damage.
6. Slots and openings on the cabinet top, back, and bottom are provided for ventilation. To ensure safe and reliable operation of this unit, and to protect it from overheating, do not block or cover these openings. Do not place this unit on a bed, sofa, rug, or similar surface, as the ventilation openings on the bottom of the cabinet will be blocked. This unit should never be placed near or over a heat register or radiator. This unit should not be placed in a built-in installation unless proper ventilation is provided.
7. This product should only be operated from the type of power source indicated on the marking label of the AC adapter. If you are not sure of the type of power available, consult your Datavideo dealer or your local power company.
8. Do not allow anything to rest on the power cord. Do not locate this unit where the power cord will be walked on, rolled over, or otherwise stressed.
9. If an extension cord must be used with this unit, make sure that the total of the ampere ratings on the products plugged into the extension cord do not exceed the extension cord rating.
10. Make sure that the total amperes of all the units that are plugged into a single wall outlet do not exceed 15 amperes.
11. Never push objects of any kind into this unit through the cabinet ventilation slots, as they may touch dangerous voltage points or short out parts that could result in risk of fire or electric shock. Never spill liquid of any kind onto or into this unit.
12. Except as specifically explained elsewhere in this manual, do not attempt to service this product yourself. Opening or removing covers that are marked "Do Not Remove" may expose you to dangerous voltage points or other risks, and will void your warranty. Refer all service issues to qualified service personnel.
13. Unplug this product from the wall outlet and refer to qualified service personnel under the following conditions:
  - a. When the power cord is damaged or frayed;
  - b. When liquid has spilled into the unit;
  - c. When the product has been exposed to rain or water;
  - d. When the product does not operate normally under normal operating conditions. Adjust only those controls that are covered by the operating instructions in this manual; improper adjustment of other controls may result in damage to the unit and may often require extensive work by a qualified technician to restore the unit to normal operation;
  - e. When the product has been dropped or the cabinet has been damaged;
  - f. When the product exhibits a distinct change in performance, indicating a need for service.

## Warranty

### Standard Warranty

- Datavideo equipment are guaranteed against any manufacturing defects for one year from the date of purchase.
- The original purchase invoice or other documentary evidence should be supplied at the time of any request for repair under warranty.
- The product warranty period begins on the purchase date. If the purchase date is unknown, the product warranty period begins on the thirtieth day after shipment from a Datavideo office.
- Damage caused by accident, misuse, unauthorized repairs, sand, grit or water is not covered under warranty.
- Viruses and malware infections on the computer systems are not covered under warranty.
- Any errors that are caused by unauthorized third-party software installations, which are not required by our computer systems, are not covered under warranty.
- All mail or transportation costs including insurance are at the expense of the owner.
- All other claims of any nature are not covered.
- Cables and batteries are not covered under warranty.
- Warranty only valid in the country or region of purchase.
- Your statutory rights are not affected.

### Three Year Warranty

- All Datavideo products purchased after July 1st, 2017 are qualified for a free two years extension to the standard warranty, providing the product is registered with Datavideo within 30 days of purchase.
- Certain parts with limited lifetime expectancy such as LCD panels, DVD drives, Hard Drive, Solid State Drive, SD Card, USB Thumb Drive, Lighting, Camera module, PCIe Card are covered for 1 year.
- The three-year warranty must be registered on Datavideo's official website or with your local Datavideo office or one of its authorized distributors within 30 days of purchase.

## Disposal



### For EU Customers only - WEEE Marking

This symbol on the product or on its packaging indicates that this product must not be disposed of with your other household waste. Instead, it is your responsibility to dispose of your waste equipment by handing it over to a designated collection point for the recycling of waste electrical and electronic equipment. The separate collection and recycling of your waste equipment at the time of disposal will help to conserve natural resources and ensure that it is recycled in a manner that protects human health and the environment. For more information about where you can drop off your waste equipment for recycling, please contact your local city office, your household waste disposal service or the shop where you purchased the product.



**CE Marking** is the symbol as shown on the left of this page. The letters "CE" are the abbreviation of French phrase "Conformité Européene" which literally means "European Conformity". The term initially used was "EC Mark" and it was officially replaced by "CE Marking" in the Directive 93/68/EEC in 1993. "CE Marking" is now used in all EU official documents.

## 1. Introduction

The RMC-185+ is a cost effective physical controller designed specifically for control of the KMU-100+ 4K Multi-Camera Processor. The RMC-185+ interfaces with the KMU-100+ via an RS-422 interface.

The RMC-185+ panel style design allows easy control of the KMU-100+ with the hard keys giving the user quick access to main functions of the KMU-100+. In addition, you can also use the joystick to move the selected frame view.

*That's Datavideo; sharing the value!*

### 1.1 Features

- Remote control of up to eight selected frame views.
- Pan, Tilt and Zoom with speed control by joystick.
- Storing multiple presets for frame view settings.
- Full remote control of the KMU-100+ via RS-422 connection.
- An LCD display showing setup menu options.
- Two Multiviewer modes (Switcher and KMU modes)
- Compact design for easy installation

### 1.2 Device Setup

The RMC-185+ is designed to control the KMU-100+. Therefore, before pairing the RMC-185+ with the KMU-100+, the user should first ensure that the two devices are installed of the two pieces of firmware as listed below:

- KMU-100+: V1.0.13932
- RMC-185+: V1.012

See [Firmware Upgrade Procedure](#) in this manual for instructions on how you can install firmware on RMC-185+. See the KMU-100+ manual for KMU-100+'s firmware upgrade procedure.

**Note: The RMC-185 cannot be used to control the KMU-100+.**

After the devices have been successfully upgraded to their corresponding firmware, connect the power to the RMC-185+ through a power cable. After that, the RMC-185+ (RJ-45) is connected to the KMU-100+ (DSub) using an RJ-45-to-DSub cable. Finally, turn ON the RMC-185+ device switch to start manipulating your KMU-100+. See the system diagram below for the overall system setup.

**Note: The communication protocol between the two devices is RS-422.**

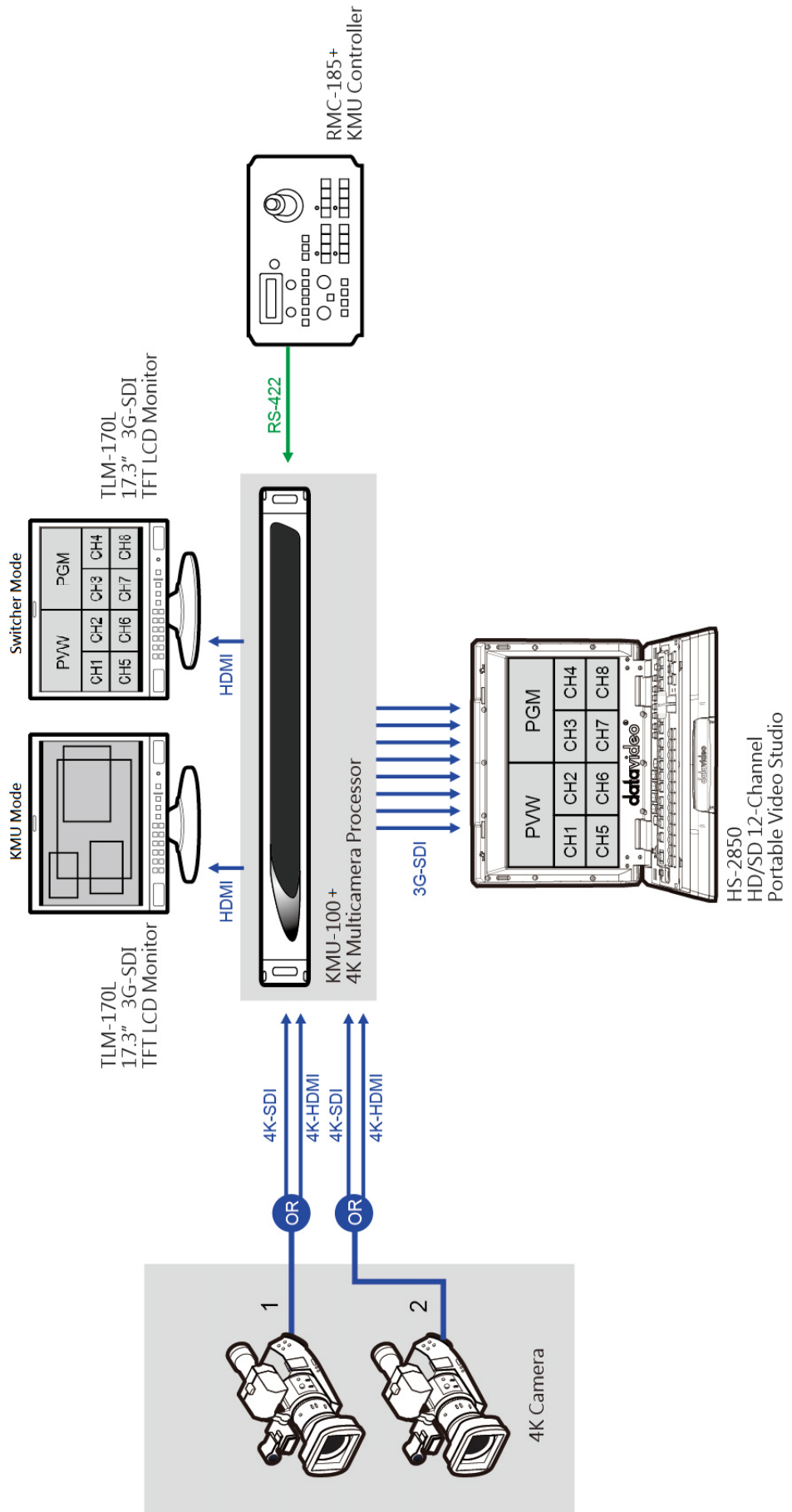

## 2. Connections and Controls

### 2.1 Front Panel – Keyboard

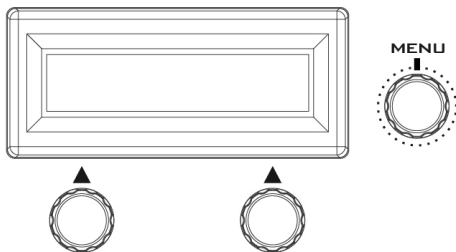
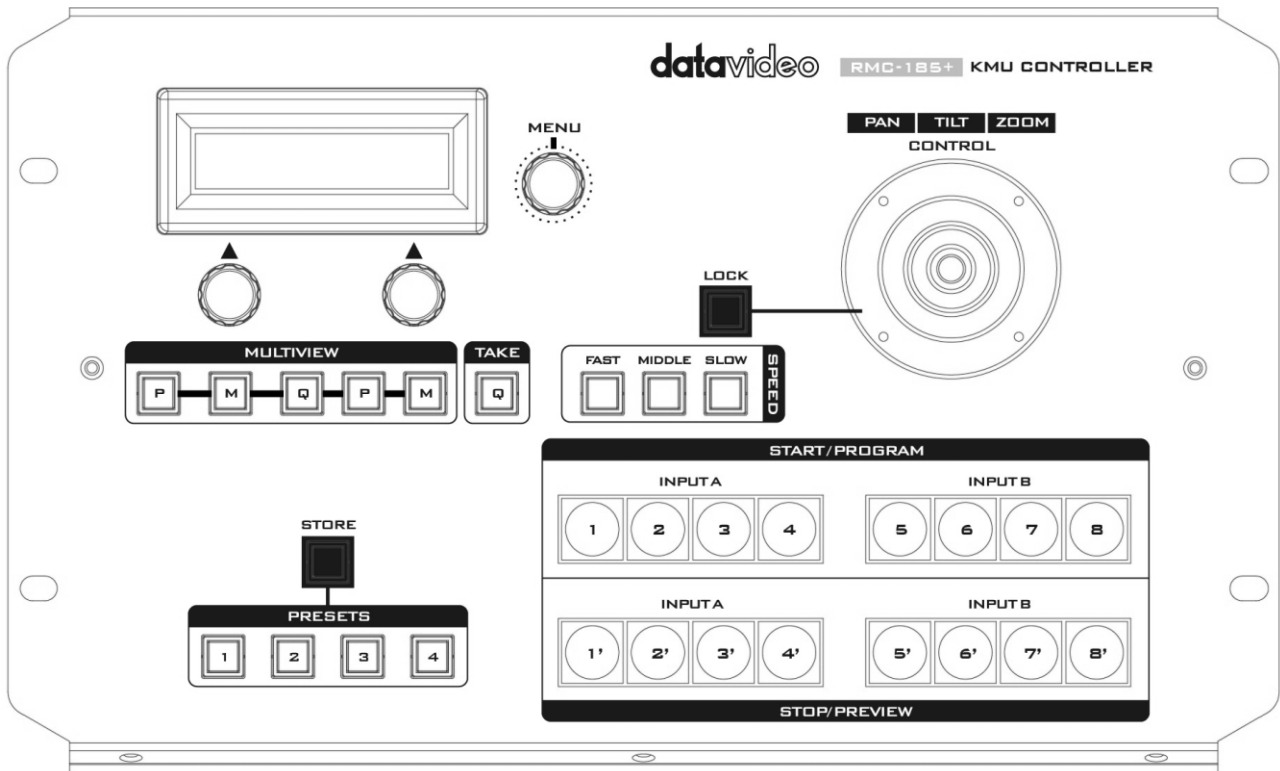

#### LCD Display

After the RMC-185+ is booted up, the **upper row of the LCD screen** should show “RMC-185 for KMU-100.”

The bottom left of the LCD screen shows the frame motion mode and by rotating the knob right below, you will be able to see the available options listed as follows:

- Single
- Loop
- PING
- TR LOOP
- TR PING
- TR PING+

Press the knob to select the mode.

The bottom right of the LCD screen shows the frame motion speed and by rotating the knob right below, you will be able to change the speed from 1 to 15. Press the knob to set the speed.



### Menu Control Knob

Push the **Menu Control Knob** to enter and browse the RMC-185+ configuration menu. Once in the menu, you can either push the menu knob to select a specific item or rotate to browse the selected menu option (or adjust the parameter value of the selected option).

Certain options of the menu will require the user to use the two knobs below the LCD screen to adjust the parameter values and these values can be set by pushing the corresponding knobs.

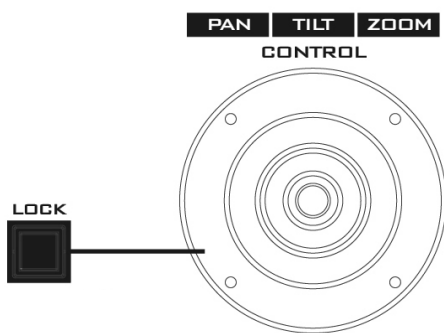

### PTZ Joystick Control

**Note:** Before attempting to use the joystick to PAN, TILT or ZOOM a selected frame, first make sure the LOCK button is not enabled.

**PAN** – Move the joystick left or right to pan the selected frame from left to right or vice versa.

**TILT** – Move the joystick up or down to tilt the selected frame up or down.

**ZOOM** – Twist the joystick clockwise (to the right) or anti-clockwise (to the left) to have the selected frame zoom in or out.

### LOCK Button

When enabled, the joystick will be in the lock state. To resume its functional status, simply press the button once to unlock the joystick.

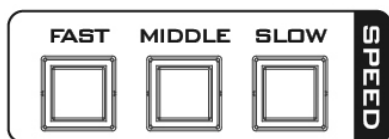

### Speed

The speed at which the selected frame moves can be chosen by pressing one of the three speed buttons.

## Multiviewer Mode Select

The Multiviewer buttons allow you to switch between different display modes.

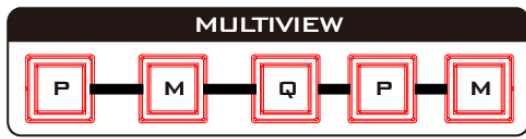

P/M

The second rightmost P button opens the multiviewer in **KMU Mode**, thus displaying current position of the selected frame.

The rightmost M button enables the Frame Motion function (playback of the motion from Start position to End position) of the selected frame in **KMU Mode**.

Q

The middle Q button opens the multiviewer in **Switcher Mode** as shown in the diagram below.

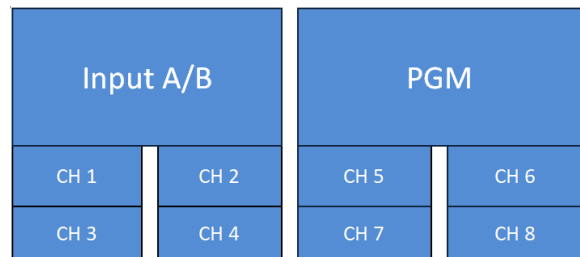

M

The second leftmost M button opens the multiviewer in **Switcher Mode** as shown in the diagram below.

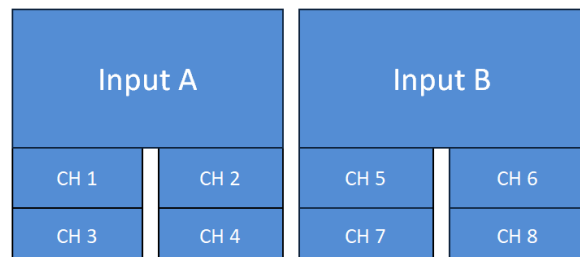

P

The leftmost P button opens the multiviewer in **Switcher Mode** as shown in the diagram below.

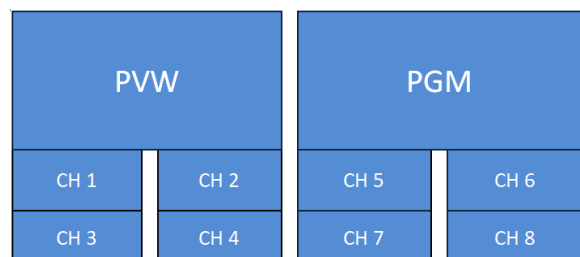



### Take

Press this **Q** button will take the preview image to air.



### STORE

Pressing this button enters the RMC-185+ into either the **STORE MODE** or **Motion Setting Mode**.



### Store Mode

When activated, this allows the current device setting to be stored in a chosen Preset Button by pressing the corresponding Preset Button. Press again to exit **STORE MODE**.

### Frame Motion Mode

Press the Store button to enter the **Motion Setting Mode** (button constantly lit). See [Section 5 Frame Motion Configuration](#) for details.

### PRESETS

The preset buttons may be used to store up to four device settings. Each button corresponds to one stored device preset. Simply press the button to recall the saved preset. Once activated, the button LED will be turned ON.

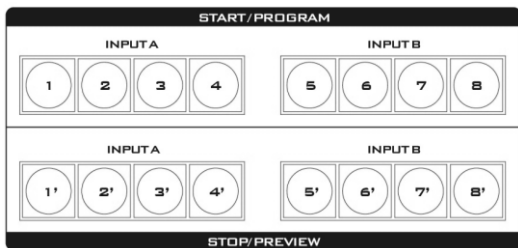

### Frame selection buttons (Top row)

Press one button (1-8) to select an active frame. After selecting an active frame, you can press the same button to switch between Start and End positions.

### Motion operation buttons (Bottom row)

Press one button to start motion of an active frame and the second button press pauses motion. Long pressing the same button for about 2 seconds will stop motion. Button LED flashes while the motion is in progress. When the motion is stopped, the button LED will stop flashing and turn to constant lit.

**Note:** See [Section 5](#) for **Frame Motion Configuration**.

## 2.2 Rear Panel - Connections

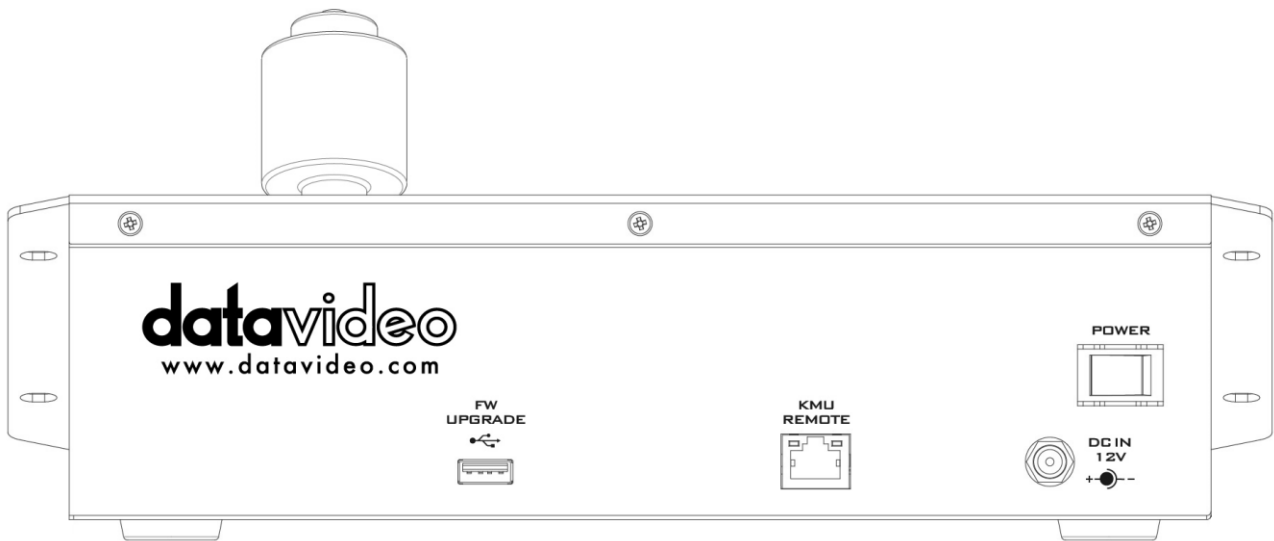

### Firmware Upgrade

USB type A port for connection to a computer during the firmware upgrade process.

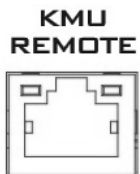

### RJ-45 port to connect the KMU-100+

The RJ-45 ports are provided on the RMC-185+ rear to connect the KMU-100+. The communication protocol is **RS-422**, so use an RJ-45-to-DSub cable to connect the RMC-185+ to the RS-422 port located on the KMU-100+ rear panel.



### DC In Socket

Connect the supplied 12V 0.5A PSU to this socket. The connection can be secured by screwing the outer fastening ring of the DC In plug to the socket.

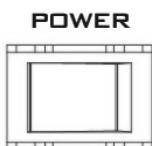

### Power On/Off Switch

Switches the device ON / OFF.

### 3. Menu Setup

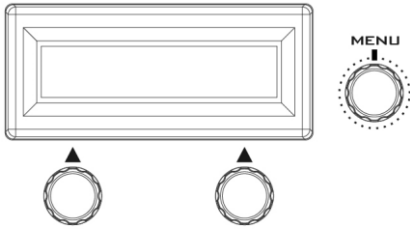

Press the **MENU** button to enter the **MENU**. The RMC-185+ status or the setup menu options are displayed on the LCD panel.

Press the dial to select a particular option and rotate the dial to browse through the option items.

<b>FN1</b>	Exit		
<b>FN2</b>	Input A Source	1 x SDI 4 x SDI HDMI Clone	
<b>FN3</b>	Input B Source	1 x SDI 4 x SDI HDMI Clone	
<b>FN4</b>	Output Format	PAL NTSC PAL 16:9 NTSC 16:9 720p 50 720p 59 720p 60 1080i 50 1080i 59 1080i 60 1080p 25 1080p 29 1080p 30 1080p 50 1080p 59 1080p 60	
<b>FN5</b>	Audio Output	Mix Follow	
<b>FN6</b>	Genlock Set	Genlock	Enable Disable
		Termination	Enable Disable
<b>FN7</b>	Genlock Status	Ref	Present Loose Lock Unlock
		Format	Detected video format Up to 1080p60

<b>FN8</b>	SDI 3G Type	Type A	
		Type B	
<b>FN9</b>	Output Assign	1~8, PVW, PGM	
		1~8, PVW, PGM	
<b>FN10</b>	Limit	720p	
		1080p	
		None	
<b>FN11</b>	Trigger Set	Motion No.	1 – 8
		Trigger Level	Rising edge
			Falling edge
<b>FN12</b>	KMU-100+ Ver.	FPGA / HARDWARE / NIOS / ARM	
<b>FN13</b>	KMU-100+ Temp	FPGA Temperature	
		PCB Board Temperature	
<b>FN14</b>	Firmware Ver.	RMC-185+ Firmware Version	

### **FN1. Exits the MENU (EXIT)**

Exits the setup menu mode.

### **FN2. Input A Source Assignment (Input A Source)**

In this option, you may select a source for input A image processing. The available interfaces are:

- 1xSDI – SDI video interface up to 12G (SD is not supported)
- 4xSDI – quad SDI video
- HDMI – HDMI 2.0
- Clone – Input B as a source

### **FN3. Input B Source Assignment (Input B Source)**

In this option, you may select a source for input B image processing. The available interfaces are:

- 1xSDI – SDI video interface up to 12G (SD is not supported)
- 4xSDI – quad SDI video
- HDMI – HDMI 2.0
- Clone – Input A as a source

### **FN4. Output Format Selection (Output Format)**

There are many video output formats available for selection. The available video output formats are listed as follows:

- PAL
- NTSC
- PAL 16:9
- NTSC 16:9
- 720p 50
- 720p 59
- 720p 60
- 1080i 50
- 1080i 59
- 1080i 60
- 1080p 25

- 1080p 29
- 1080p 30
- 1080p 50
- 1080p 59
- 1080p 60

## **FN5. Audio Output**

If **Audio Follow** is selected, audio settings are described below:

SDI Ch 1 / 2 / 3 / 4: **Input A audio**

SDI Ch 5 / 6 / 7 / 8: **Input B audio**

**Audio Mix: Input A audio** and **Input B audio** will be simultaneously on the **HDMI OUT2 (PGM)**.

**Note:** The Audio Mix option will be available only if **Mix HDMI OUT2 (PGM)** or **SDI OUT** is set to PVW / PGM.

## **FN6. Genlock Setting (Genlock Set)**

This option enables/disables the genlock functionality and turns ON/OFF internal 75 Ohm termination.

## **FN7. Genlock Status Display (Genlock Status)**

Display current genlock status by returning values detected from sync signal.

## **FN8. Selection of SDI 3G Type (SDI 3G Type)**

Enabling of 3G-SDI signal type on output ports (available modes are Type A and Type B).

## **FN9. Output Assign**

This option sets SDI Output 1-8 to either one of 1-8, PVW and PGM.

EX: All SDI Output 1-8 can be set to PGM view.

## **FN10. Limit**

This option limits the minimum size of the motion window.

**Note:** *LIMIT is available for 4K input only.*

## **FN11. External Motion Trigger Setting (Trigger Set)**

In this option, you will be able to configure the external motion trigger method. Motion 1-8 can be controlled by an external device using the level trigger method. You can either set the trigger method to low level trigger or high level trigger.

## **FN12. KMU-100+ Firmware Version Display (KMU-100+ Ver.)**

Upon entering the **KMU-100+ Ver.** Option, the KMU-100+ firmware version will be displayed.

## **FN13. Display of KMU-100+ FPGA and PCB Board Temperatures (KMU-100+ Temp)**

In the **KMU-100+ Temp** option, you will be able to check measured temperatures of the KMU-100+ FPGA and PCB boards.

## **FN14. RMC-185+ Firmware Version Display (Firmware Ver.)**

Upon entering the **Firmware Ver.** option, the RMC-185+ firmware version will be displayed.

## 4. Storing Different Device Settings

The RMC-185+ allows you to store up to four device settings. Follow the procedure below to store the current device setting to one of the preset buttons.

To store a device setting:

1. Adjust the frame positions using the joystick.
2. Push the **STORE** button and it will turn red.



3. Press a preset button to save the current device setting.



4. The selected preset button will remain ON for 2-3 seconds and the button LED will be turned OFF after the device setting is successfully saved.



## 5. Frame Motion Configuration

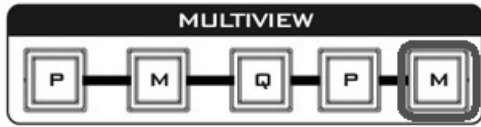

1. First enable the rightmost M button of the MULTIVIEW button row.

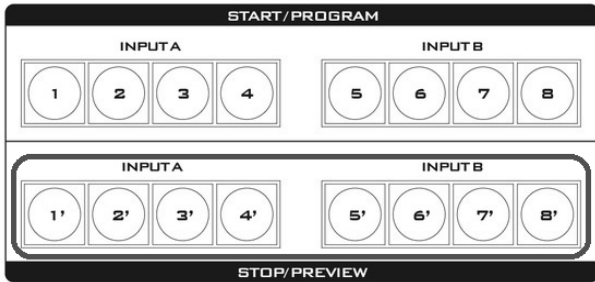

2. Press one of the STOP row buttons (buttons 1' to 8') to select a frame to adjust its motion setting.

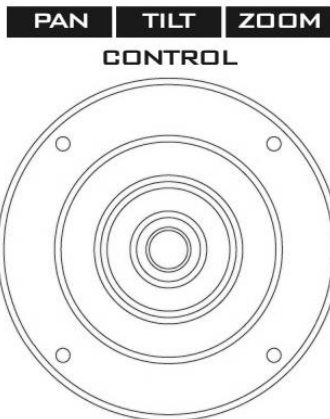

3. Use the joystick to zoom the frame and adjust its start position (fine border frame).

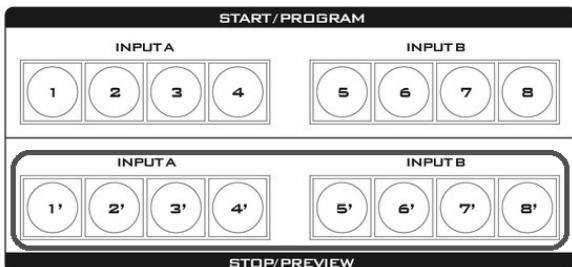

4. Press the button (one of the STOP row buttons 1' to 8') selected at Step 2 again.

PAN | TILT | ZOOM  
CONTROL

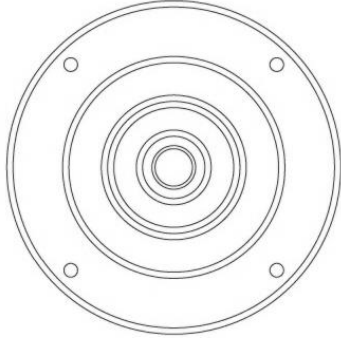

STORE

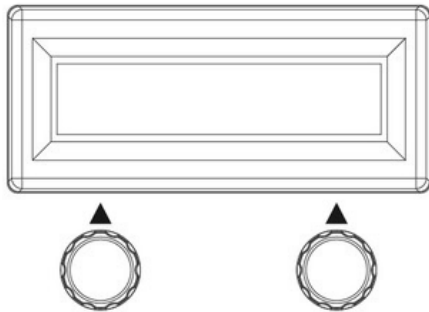

5. Use the joystick to zoom the frame and adjust its end position (thick border frame).

6. Press the STORE button (constantly lit).

7. Use the left knob below the LCD screen to set the Frame Motion Mode and the right knob to set the Frame Motion Speed.

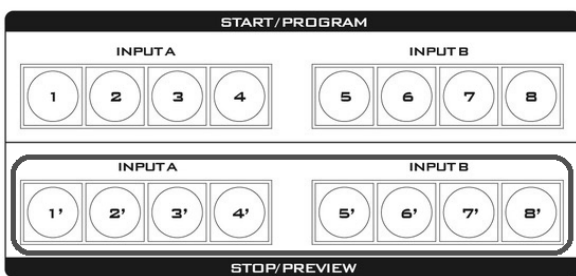

8. Press the button (one of the STOP row buttons 1' to 8') selected at Step 2 again to trigger the frame motion.

## 6. Firmware Upgrade Procedure

From time to time, Datavideo may release new firmware to either add new features or to fix reported bugs in the current RMC-185+ firmware. Customers can update the firmware themselves if they wish or they can contact their local dealer or reseller for assistance should they prefer this method.

This section describes the firmware update process and it should take **approximately few minutes to complete**. Once started, **the update process should not be interrupted in any way** as this could result in a non-responsive unit.

### Requirement

- Latest firmware update files (bootloader and application firmware)
- A USB A to USB A cable not longer than 2 meters
- A Windows PC with USB 2.0 ports or above

1. Power off the RMC-185+ and use a USB cable (USB A to USB A) to connect the USB firmware

upgrade port  on the RMC-185+ rear panel to a USB port on the PC.

2. Press and hold the four buttons indicated with  at the same time.

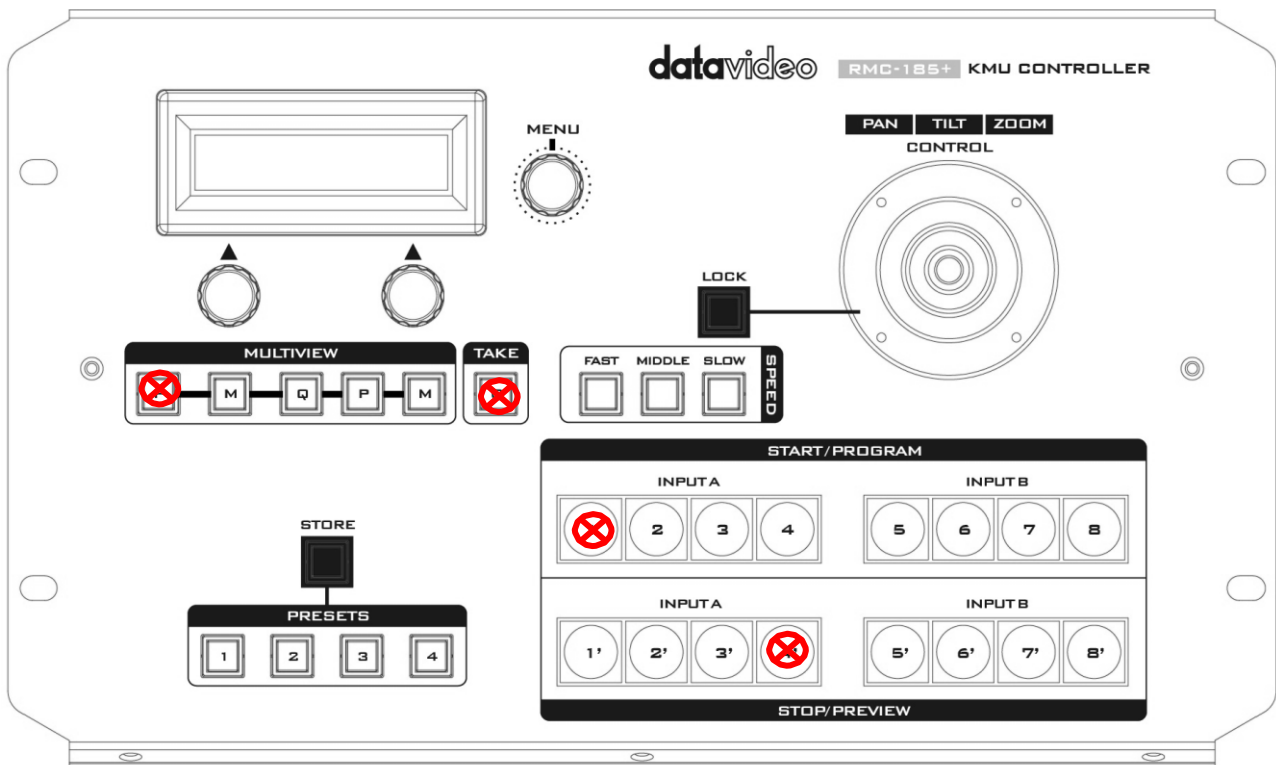

3. With an assistant's help, one person switches on the RMC-185+ device while another person presses and holds the buttons indicated with .

4. The user may release the buttons once the RMC-185+ LCD panel displays the following

information.

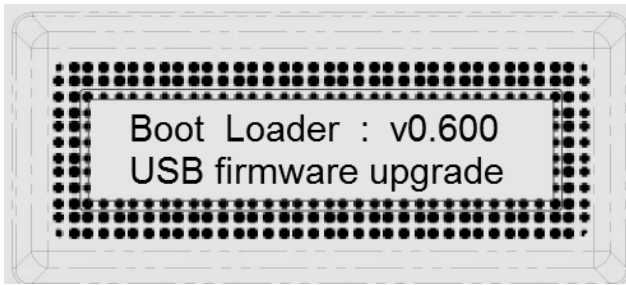

5. The RMC-185+ device (**RMC-185+\_U38**) will appear as a removable storage device on the PC as shown below.

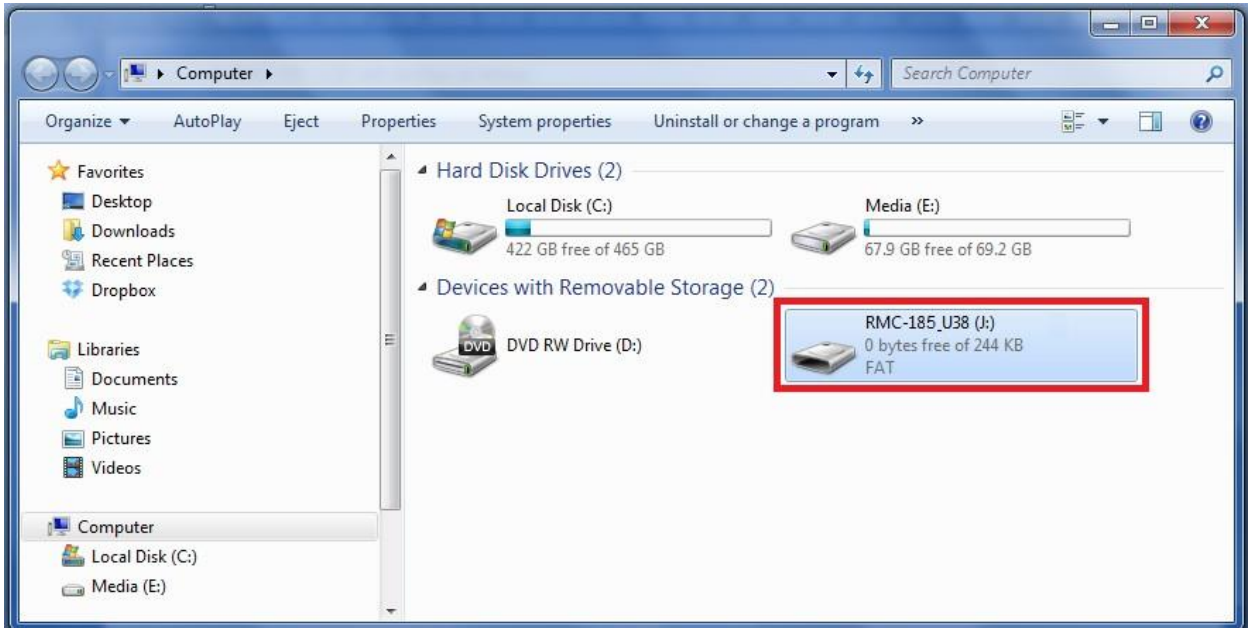

6. Double click the RMC-185\_U38 removable storage device and delete the "bootcode.bin" file.
7. Copy and paste the latest bootloader firmware file (bootcode.bin) into the RMC-185\_U38 removable storage device.
8. Reboot the RMC-185+ device until the LCD displays the following.

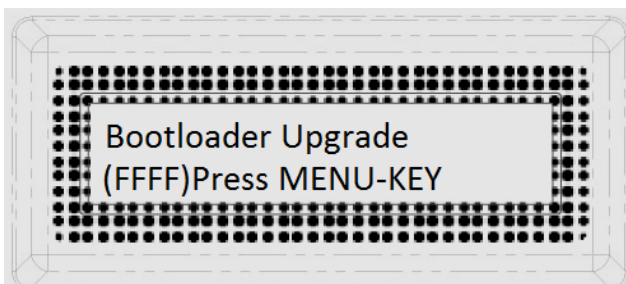

9. Press the MENU key to start the firmware upgrade and do not disconnect the power before the upgrade is complete.

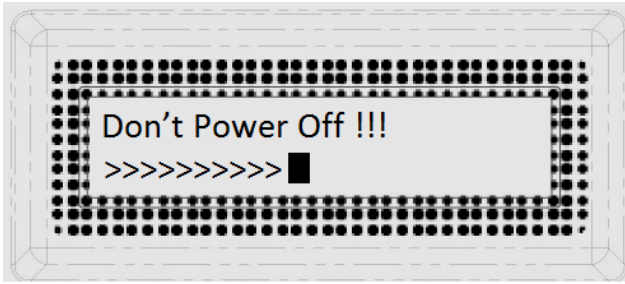

10. After the bootloader firmware upgrade is complete, the LCD display will show the following and the user may proceed to upgrading the application firmware.

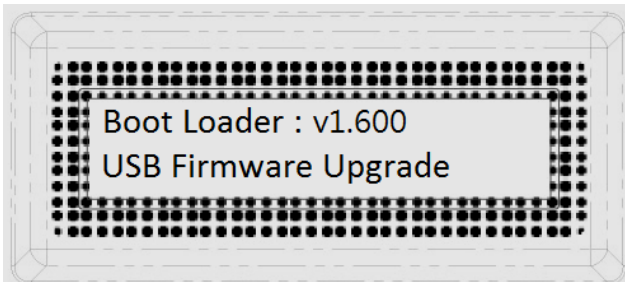

11. Remove bootcode.bin from the RMC-185+ device and copy and paste the application firmware into the RMC-185+ device.

Name	Date modified	Type	Size
 RMC185	2015/5/14	BIN	76 KB

12. Reboot the RMC-185+ device again and the LCD display will now show the following.

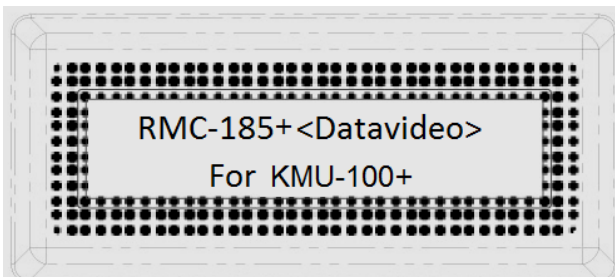

13. The RMC-185+ device is now ready for controlling the connected KMU device.

## 7. Frequently-Asked Questions

This section describes problems that you may encounter while using RMC-185+. If you have any questions, please refer to related sections and follow all suggested solutions. If problem still exists, please contact your distributor or the service center.

No.	Problems	Solutions
1.	What is the RJ-45 port used for?	It is used for connecting the RMC-185+ to the KMU-100+. Please use an RJ-45-to-DSub cable. The DSub end should be a male connector.

## 8. Dimensions

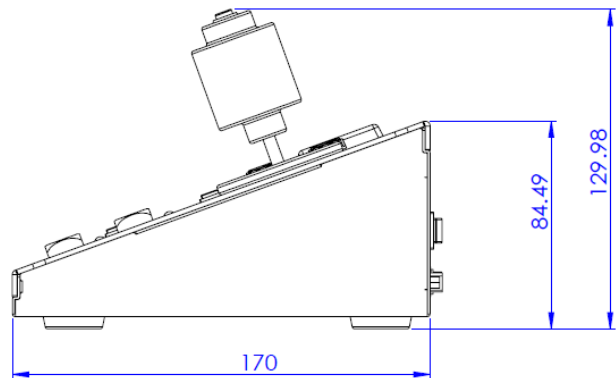
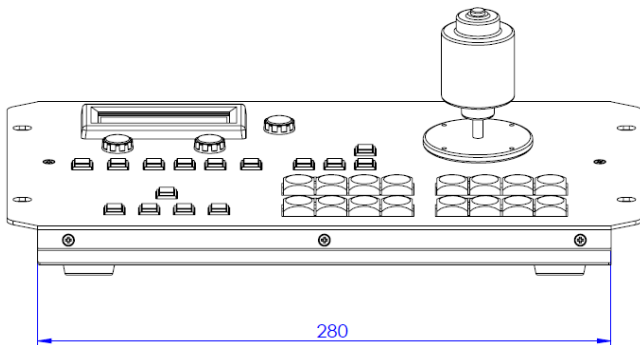
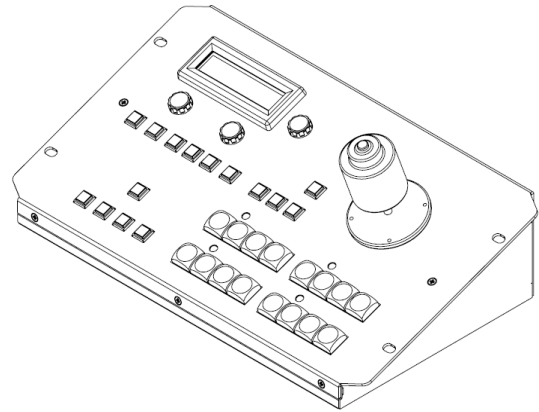
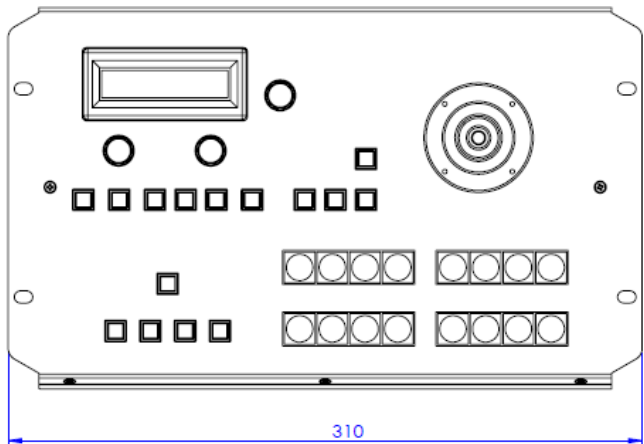

All measurements in millimeters (mm)

## 9. Specifications

RMC-185+ KMU Controller	
<b>Firmware Upgrade</b>	USB
<b>Power</b>	DC 12V 0.5A
<b>Dimensions (W x H x D)</b>	310 x 129.98 x 170 (mm)
<b>Net Weight</b>	1.5 Kg
<b>Gross Weight</b>	2.0 Kg
<b>Operating Temperature</b>	0°C to 50°C (32°F to 122°F)
<b>Humidity</b>	10% to 80%

# Service & Support

It is our goal to make owning and using Datavideo products a satisfying experience. Our support staff is available to assist you to set up and operate your system. Contact your local office for specific support requests. Plus, please visit [www.datavideo.com](http://www.datavideo.com) to access our FAQ section.

**China Shanghai**  
Datavideo Technologies China Co  
601, Building 10, No. 1228,  
Rd. Jiangchang,  
Jingan District, Shanghai  
Tel: +86 21-5603 6599  
Fax: +86 21-5603 6770  
E-mail: [service@datavideo.cn](mailto:service@datavideo.cn)

**China Beijing**  
Datavideo Technologies China Co  
No. 812, Building B, Wankai Center,  
No. 316, Wan Feng Road, Fengtai District,  
Beijing, China  
Tel: +86 10-8586 9034  
Fax: +86 10-8586 9074  
E-mail: [service@datavideo.cn](mailto:service@datavideo.cn)

**China Chengdu**  
Datavideo Technologies China Co  
B-823, Meinian square, No. 1388,  
Middle of Tianfu Avenue, Gaoxin District,  
Chengdu, Sichuan  
Tel: +86 28-8613 7786  
Fax: +86 28-8513 6486  
E-mail: [service@datavideo.cn](mailto:service@datavideo.cn)

**China Fuzhou**  
Datavideo Technologies China Co  
A1-2318-19 Room, No. 8, Aojiang Road,  
Taijiang District, Fuzhou, Fujian, China  
Tel: 0591-83211756 · 0591-83210187  
Fax: 0591-83211262  
E-mail: [service@datavideo.cn](mailto:service@datavideo.cn)

**China Jinan**  
Datavideo Technologies China Co  
902, No. 1 business building,  
Xiangtai Square, No. 129,  
Yingxiangshan Road, Shizhong District,  
Jinan City, Shandong Province, China  
Tel: +86 531-8607 8813  
E-mail: [service@datavideo.cn](mailto:service@datavideo.cn)

**Hong Kong**  
Datavideo Hong Kong Ltd  
G/F., 26 Cross Lane  
Wanchai, Hong Kong  
Tel: +852-2833-1981  
Fax: +852-2833-9916  
E-mail: [info@datavideo.com.hk](mailto:info@datavideo.com.hk)

**India Noida**  
Datavideo India Noida  
A-132, Sec-63, Noida-201307,  
India  
Tel: +91-0120-2427337  
Fax: +91-0120-2427338  
E-mail: [sales@datavideo.in](mailto:sales@datavideo.in)

**India Kochi**  
Datavideo India Kochi  
2nd Floor- North Wing, Govardhan Building,  
Opp. NCC Group Headquarters, Chittoor Road,  
Cochin- 682035  
Tel: +91 4844-025336  
Fax: +91 4844-047696  
E-mail: [sales@datavideo.in](mailto:sales@datavideo.in)

**Netherlands**  
Datavideo Technologies Europe BV  
Floridadreef 106  
3565 AM Utrecht,  
The Netherlands  
Tel: +31-30-261-96-56  
Fax: +31-30-261-96-57  
E-mail: [info@datavideo.nl](mailto:info@datavideo.nl)

**Singapore**  
Datavideo Visual Technology(S) Pte Ltd  
No. 178 Paya Lebar Road #06-07  
Singapore 409030  
Tel: +65-6749 6866  
Fax: +65-6749 3266  
E-mail: [info@datavideovirtualset.com](mailto:info@datavideovirtualset.com)

**Singapore**  
Datavideo Technologies (S) PTE Ltd  
No. 178 Paya Lebar Road #06-03  
Singapore 409030  
Tel: +65-6749 6866  
Fax: +65-6749 3266  
E-mail: [sales@datavideo.sg](mailto:sales@datavideo.sg)

**Taiwan**  
Datavideo Technologies Co. Ltd  
10F. No. 176, Jian 1st Rd., Chung Ho  
District, New Taipei City 235, Taiwan  
Tel: +886-2-8227-2888  
Fax: +886-2-8227-2777  
E-mail: [service@datavideo.com.tw](mailto:service@datavideo.com.tw)

**United States**  
Datavideo Corporation  
7048 Elmer Avenue.  
Whittier, CA 90602,  
U.S.A.  
Tel: +1-562-696 2324  
Fax: +1-562-698 6930  
E-mail: [sales@datavideo.com](mailto:sales@datavideo.com)

**United Kingdom**  
Datavideo UK Limited  
Brookfield House, Brookfield Industrial  
Estate, Peakdale Road, Glossop,  
Derbyshire, SK13 6LQ  
Tel: +44-1457 851 000  
Fax: +44-1457 850 964  
E-mail: [sales@datavideo.co.uk](mailto:sales@datavideo.co.uk)

**France**  
Datavideo France s.a.r.l.  
Cit  Descartes 1, rue Albert Einstein  
Champs sur Marne 774477 –  
Marne la Vall e cedex 2  
Tel: +33-1-60370246  
Fax: +33-1-60376732  
E-mail: [info@datavideo.fr](mailto:info@datavideo.fr)



Please visit our website for latest manual update.  
[www.datavideo.com/product/RMC-185](http://www.datavideo.com/product/RMC-185)

**datavideo**  
[www.datavideo.com](http://www.datavideo.com)