

datavideo

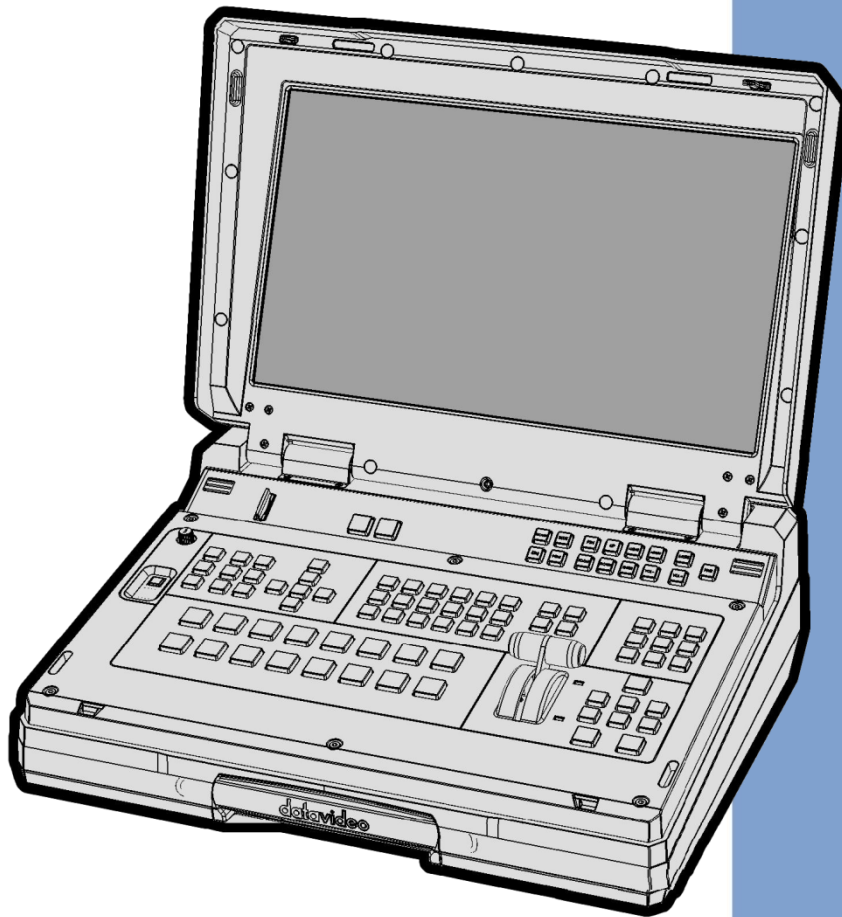

**HD 6 CHANNEL
PORTABLE VIDEO
STREAMING STUDIO**

HS-1300

Instruction manual

www.datavideo.com

Contents

FCC COMPLIANCE STATEMENT	4
WARNINGS AND PRECAUTIONS	4
WARRANTY	5
<i>STANDARD WARRANTY</i>	<i>5</i>
<i>THREE YEAR WARRANTY</i>	<i>5</i>
DISPOSAL	6
CHAPTER 1 INTRODUCTION.....	7
1.1 FEATURES	7
1.2 SYSTEM DIAGRAM.....	8
CHAPTER 2 CONNECTIONS AND CONTROLS.....	9
2.1 REAR PANEL CONNECTIONS.....	10
2.2 SWITCHER CONTROL PANEL	12
<i>User Memory and Function Keys</i>	<i>12</i>
<i>Menu Control.....</i>	<i>12</i>
<i>Keyer Selection</i>	<i>12</i>
<i>Keyer Source</i>	<i>13</i>
<i>PIP Effect.....</i>	<i>13</i>
<i>Background Transition & GRAB</i>	<i>13</i>
<i>Wipe Border Setting</i>	<i>13</i>
<i>Wipe Transition Selection.....</i>	<i>13</i>
<i>Program & Preview Source Row</i>	<i>14</i>
<i>Transition Effect.....</i>	<i>15</i>
<i>Audio Control.....</i>	<i>16</i>
2.3 MONITOR CONTROL PANEL.....	16
CHAPTER 3 NETWORK SETUP	19
3.1 SWITCHER SETUP WITH A WINDOWS COMPUTER	19
3.2 INSTALLING THE SWITCHER IMAGE IMPORT/EXPORT SOFTWARE TO A WINDOWS COMPUTER	20
<i>Router Based DHCP Setup</i>	<i>21</i>
<i>Setting the Target IP Address with the Switcher Image Import/Export Software</i>	<i>22</i>
CHAPTER 4 SWITCHER OSD MENU.....	24
4.1 OVERVIEW.....	24
4.2 FUNCTIONS.....	30
<i>Start</i>	<i>30</i>
<i>Keyer.....</i>	<i>31</i>
<i>Chroma</i>	<i>32</i>
<i>P-in-P</i>	<i>33</i>
<i>P-in-P Lite.....</i>	<i>34</i>
<i>Inputs.....</i>	<i>35</i>
<i>Outputs.....</i>	<i>36</i>
<i>Stills</i>	<i>37</i>
<i>User Mems.....</i>	<i>38</i>
<i>Setup.....</i>	<i>39</i>
CHAPTER 5 VIDEO STREAMING.....	41
5.1 NETWORK CONNECTION AND SETUP.....	41

<i>Finding the NVS-31's current IP address.....</i>	41
5.2 WEB USER INTERFACE	42
<i>Source.....</i>	43
<i>Encoder.....</i>	43
<i>Record.....</i>	46
<i>Streaming.....</i>	47
<i>System.....</i>	51
CHAPTER 6 ADVANCED OPERATIONS.....	54
6.1 STILL IMAGES	54
<i>Export/Import Still Images to/from the PC.....</i>	54
<i>Loading still images.....</i>	60
6.2 STINGER TRANSITION EFFECT	61
<i>Loading the existing Clip for Stinger Transition Effect.....</i>	61
<i>Importing the Clip for Stinger Transition Effect from the PC.....</i>	62
<i>How to Create the PNG Sequence for Stinger Transition Effect.....</i>	64
<i>Important things to note while creating Stinger Transition Effects.....</i>	69
6.3 CHROMAKEYER.....	70
6.4 DUAL CHROMAKEY.....	71
6.5 USER MEMORY	73
<i>Export/Import User Memory Preset to/from the PC.....</i>	73
<i>Loading User Memory Preset.....</i>	75
CHAPTER 7 MONITOR OSD MENU OPTIONS.....	76
7.1 MAIN ADJUST	77
7.2 COLOR.....	77
7.3 INFORMATION	77
7.4 SPECIAL FUNCTION.....	77
7.5 FACTORY RESET	78
APPENDICES.....	79
SWITCHER FIRMWARE UPDATE PROCEDURE	79
GPI CONNECTION.....	80
TALLY OUTPUTS.....	81
FREQUENTLY-ASKED QUESTIONS.....	82
DIMENSIONS.....	83
SPECIFICATIONS	84
SERVICE AND SUPPORT.....	87

Disclaimer of Product and Services

The information offered in this instruction manual is intended as a guide only. At all times, Datavideo Technologies will try to give correct, complete and suitable information. However, Datavideo Technologies cannot exclude that some information in this manual, from time to time, may not be correct or may be incomplete. This manual may contain typing errors, omissions or incorrect information. Datavideo Technologies always recommend that you double check the information in this document for accuracy before making any purchase decision or using the product. Datavideo Technologies is not responsible for any omissions or errors, or for any subsequent loss or damage caused by using the information contained within this manual. Further advice on the content of this manual or on the product can be obtained by contacting your local Datavideo Office or dealer.

FCC Compliance Statement

This device complies with part 15 of the FCC rules. Operation is subject to the following two conditions:

1. This device may not cause harmful interference, and
2. This device must accept any interference received, including interference that may cause undesired operation.

Warnings and Precautions

1. Read all of these warnings and save them for later reference.
2. Follow all warnings and instructions marked on this unit.
3. Unplug this unit from the wall outlet before cleaning. Do not use liquid or aerosol cleaners. Use a damp cloth for cleaning.
4. Do not use this unit in or near water.
5. Do not place this unit on an unstable cart, stand, or table. The unit may fall, causing serious damage.
6. Slots and openings on the cabinet top, back, and bottom are provided for ventilation. To ensure safe and reliable operation of this unit, and to protect it from overheating, do not block or cover these openings. Do not place this unit on a bed, sofa, rug, or similar surface, as the ventilation openings on the bottom of the cabinet will be blocked. This unit should never be placed near or over a heat register or radiator. This unit should not be placed in a built-in installation unless proper ventilation is provided.
7. This product should only be operated from the type of power source indicated on the marking label of the AC adapter. If you are not sure of the type of power available, consult your Datavideo dealer or your local power company.
8. Do not allow anything to rest on the power cord. Do not locate this unit where the power cord will be walked on, rolled over, or otherwise stressed.
9. If an extension cord must be used with this unit, make sure that the total of the ampere ratings on the products plugged into the extension cord do not exceed the extension cord's rating.
10. Make sure that the total amperes of all the units that are plugged into a single wall outlet do not exceed 15 amperes.
11. Never push objects of any kind into this unit through the cabinet ventilation slots, as they may touch dangerous voltage points or short out parts that could result in risk of fire or electric shock. Never spill liquid of any kind onto or into this unit.
12. Except as specifically explained elsewhere in this manual, do not attempt to service this product yourself. Opening or removing covers that are marked "Do Not Remove" may expose you to dangerous voltage points or other risks, and will void your warranty. Refer all service issues to qualified service personnel.
13. Unplug this product from the wall outlet and refer to qualified service personnel under the following conditions:
 - a. When the power cord is damaged or frayed;
 - b. When liquid has spilled into the unit;
 - c. When the product has been exposed to rain or water;
 - d. When the product does not operate normally under normal operating conditions. Adjust only those controls that are covered by the operating instructions in this manual; improper adjustment of other controls may result in damage to the unit and may often require extensive work by a qualified technician to restore the unit to normal operation;
 - e. When the product has been dropped or the cabinet has been damaged;
 - f. When the product exhibits a distinct change in performance, indicating a need for service.



Warranty

Standard Warranty

- Datavideo equipment are guaranteed against any manufacturing defects for one year from the date of purchase.
- The original purchase invoice or other documentary evidence should be supplied at the time of any request for repair under warranty.
- The product warranty period begins on the purchase date. If the purchase date is unknown, the product warranty period begins on the thirtieth day after shipment from a Datavideo office.
- All non-Datavideo manufactured products (product without Datavideo logo) have only one year warranty from the date of purchase.
- Damage caused by accident, misuse, unauthorized repairs, sand, grit or water is not covered under warranty.
- Viruses and malware infections on the computer systems are not covered under warranty.
- Any errors that are caused by unauthorized third-party software installations, which are not required by our computer systems, are not covered under warranty.
- All mail or transportation costs including insurance are at the expense of the owner.
- All other claims of any nature are not covered.
- All accessories including headphones, cables, and batteries are not covered under warranty.
- Warranty only valid in the country or region of purchase.
- Your statutory rights are not affected.

Three Year Warranty

- All Datavideo products purchased after July 1st, 2017 are qualified for a free two years extension to the standard warranty, providing the product is registered with Datavideo within 30 days of purchase.
- Certain parts with limited lifetime expectancy such as LCD panels, DVD drives, Hard Drive, Solid State Drive, SD Card, USB Thumb Drive, Lighting, Camera module, PCIe Card are covered for 1 year.
- The three-year warranty must be registered on Datavideo's official website or with your local Datavideo office or one of its authorized distributors within 30 days of purchase.



Disposal

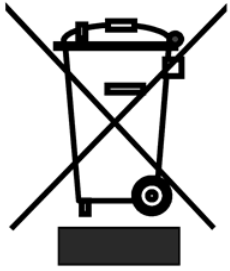

For EU Customers only - WEEE Marking

This symbol on the product or on its packaging indicates that this product must not be disposed of with your other household waste. Instead, it is your responsibility to dispose of your waste equipment by handing it over to a designated collection point for the recycling of waste electrical and electronic equipment. The separate collection and recycling of your waste equipment at the time of disposal will help to conserve natural resources and ensure that it is recycled in a manner that protects human health and the environment. For more information about where you can drop off your waste equipment for recycling, please contact your local city office, your household waste disposal service or the shop where you purchased the product.



CE Marking is the symbol as shown on the left of this page. The letters "CE" are the abbreviation of French phrase "Conformité Européene" which literally means "European Conformity". The term initially used was "EC Mark" and it was officially replaced by "CE Marking" in the Directive 93/68/EEC in 1993. "CE Marking" is now used in all EU official documents.

Chapter 1 Introduction

HS-1300 features an easy-to-use video streaming and recording appliance for professional video producers who need to simultaneously stream a live event and record the master quality version for post-editing.

The HS-1300 is a cost effective 6 channel broadcast-quality hand-carry mobile switcher, it is designed for live events and TV programs that need to mix a variety of video and audio sources. The HS-1300 is a lightweight, portable and powerful featured mobile studio solution.

Friendly and advanced features include a 17.3-inch video monitor, which displays the multi-view. The Multi-view includes all the input sources, as well as preview and program.

1.1 Features

- Simultaneous Live Streaming & Recording
- Broadcast quality HD / SD H.264 network streaming
- Support different bitrate for recording and streaming
- 6 video inputs (SDI x 4 + HDMI x 2)
- 5 Video Output: (SDI x 2 + HDMI x 3)
- 2 x XLR Analogue Audio Inputs
- Flexible Mix/Effects Processor with
 - 2 Upstream Keyers supporting Chroma Key & Linear/Luma Key
 - 2 DSK supporting Linear & Luma Key Modes
 - 1 PIP (assignable to any of the 4 keyers)
 - Wipe, Mix & Cut Transitions
 - Full M/E Preview function
- Any Input (1-6) can be used as a Frame store (Stills Store)
- XPT (Cross Point Assignment)
- Tally output
- GPI Output
- One 17.3-inch with a resolution of 1600x900 dots
- Easy to use On-screen Menu System for quick setting of parameters

1.2 System Diagram

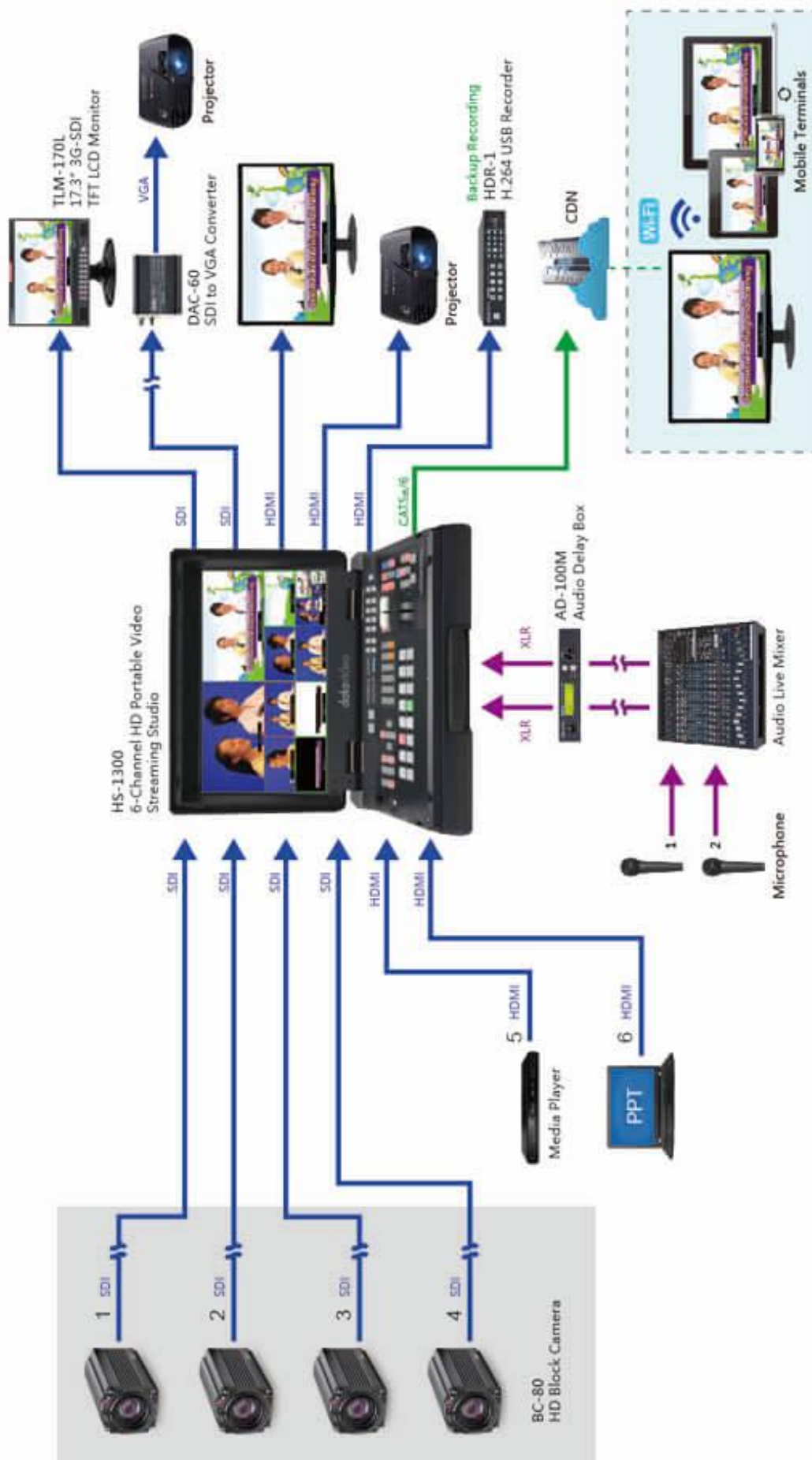

Chapter 2 Connections and Controls

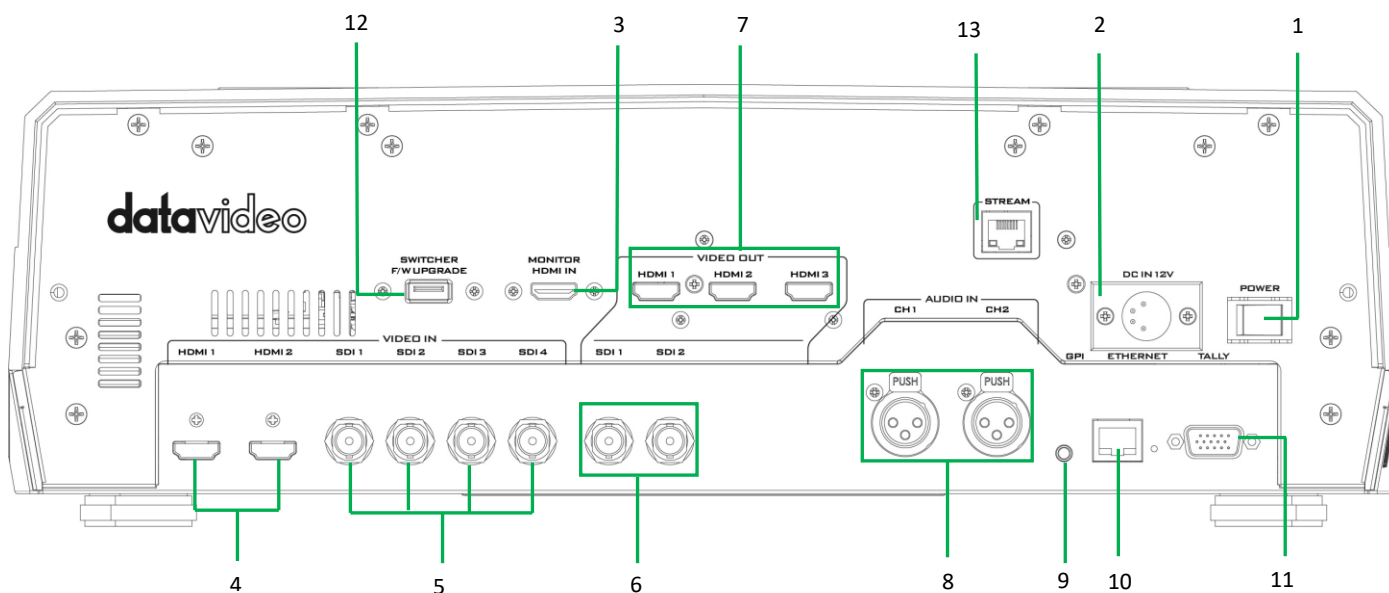

- | | |
|---|--------------------------------------|
| 1 Power Switch | 8 3 PIN XLR Audio Input 1 – 2 |
| 2 4 PIN XLR Power Input Connector | 9 GPI Output Connector |
| 3 Monitor HDMI IN (External Video Input) | 10 Ethernet Port |
| 4 HDMI Video Input 1 – 2 | 11 Tally Signal Output |
| 5 HD-SDI Video Input 1 – 4 | 12 USB Firmware Upgrade Port |
| 6 HD-SDI Video Output 1 – 2 | 13 Stream Port |
| 7 HDMI Video Output 1 – 3 | |

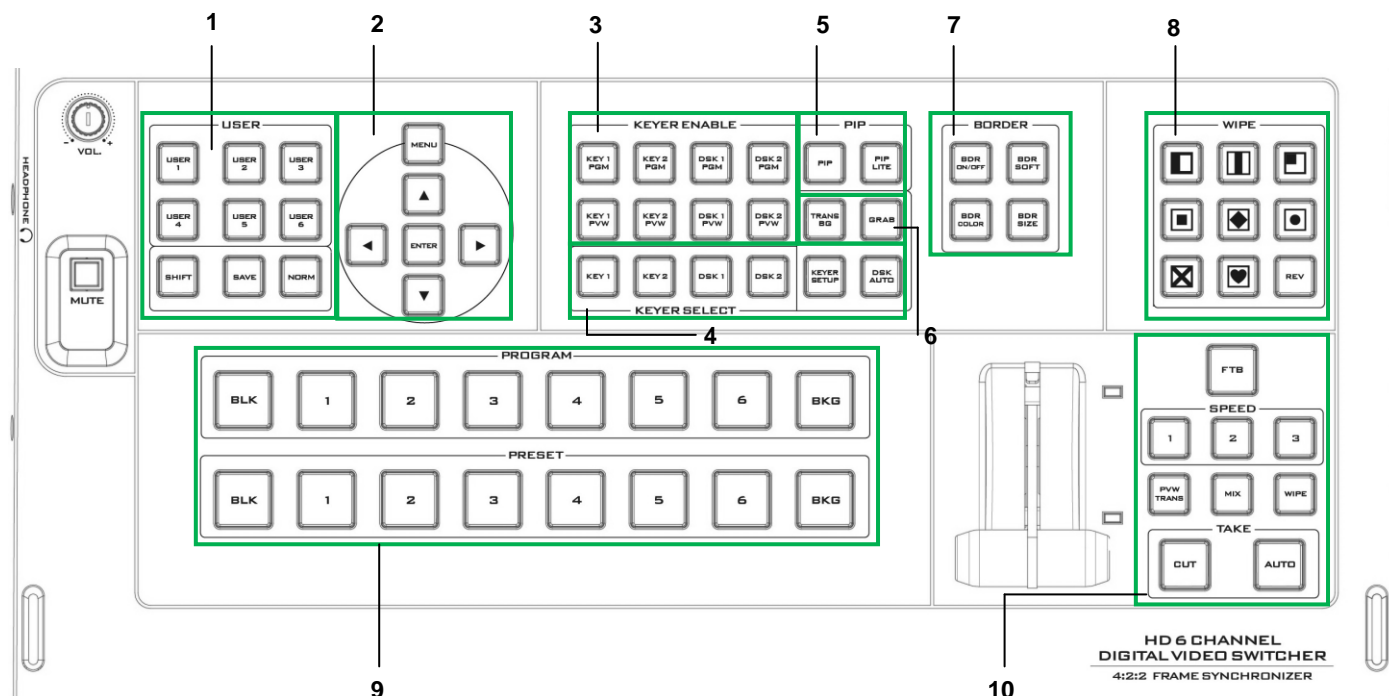

- | | |
|--------------------------------------|--|
| 1 User Memory & Function Keys | 6 Background Transition & GRAB |
| 2 Menu Control | 7 Wipe Border Setting |
| 3 Keyer Selection | 8 Wipe Transition Selection |
| 4 Keyer Source | 9 Program & Preview source rows |
| 5 PIP Effect | 10 Transition Effect |

2.1 Rear Panel Connections

POWER

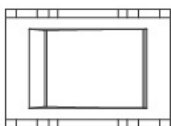

1. POWER SWITCH

Switches the power On / Off.

DC IN 12V

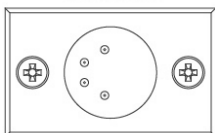

2. DC Power Input

Connect the supplied 12V 5A PSU to this 4 PIN XLR socket.

MONITOR HDMI IN



3. Monitor HDMI IN (External Video Input)

The HS-1300 provides a useful connection for confidence monitoring of HDMI sources on location.

Connect one external HDMI input source for monitoring the live show.

Video Input Modules: The HS-1300 is equipped with six video input channels. Connect the respective video sources to these video input channels.

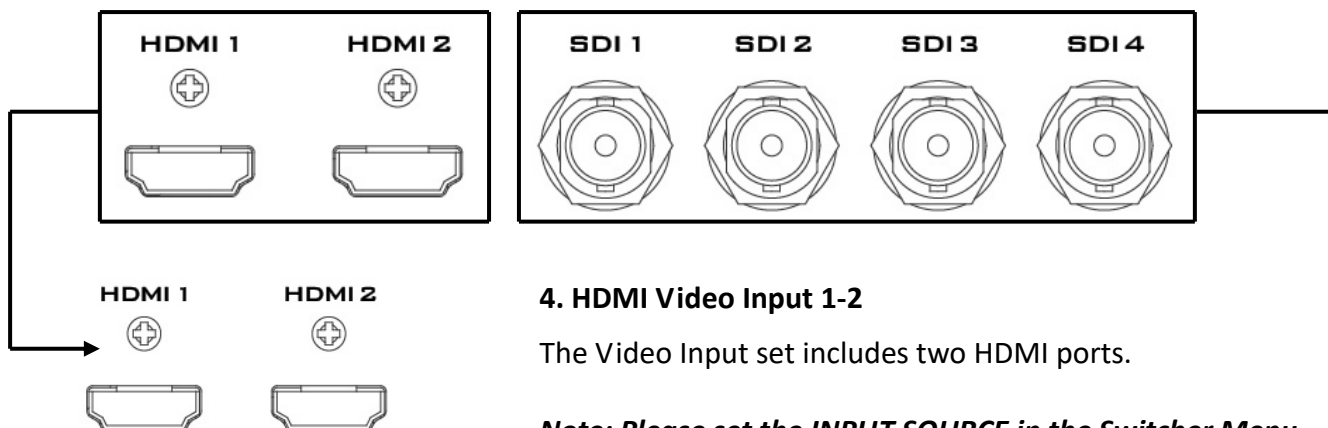

4. HDMI Video Input 1-2

The Video Input set includes two HDMI ports.

Note: Please set the INPUT SOURCE in the Switcher Menu.

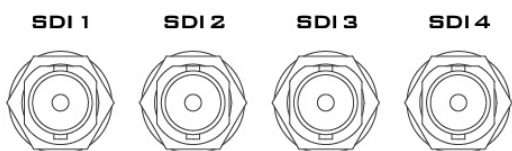

5. SDI Video Input 1-4

The Video Input set includes four SDI connectors.

Note: Please set the INPUT SOURCE in the Switcher Menu.

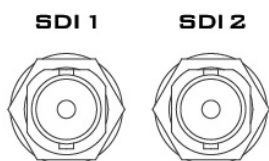

6. SDI Video Output 1-2

The BNC output connector is a user defined SDI output.

Note: Please set the OUTPUT SOURCE in the Switcher Menu.



7. HDMI Video Output

All three HDMI ports output Program video.

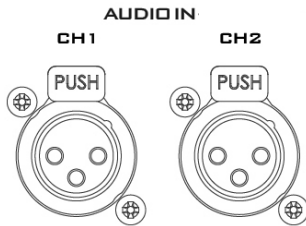

8. AUDIO Input 1-2

Supports two XLR Balanced Audio Input channels.

GPI



9. GPI Output

The GPI socket can be used for simple external control.

Note: Please configure GPI settings in the Switcher Menu.

ETHERNET

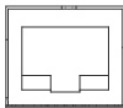

10. Ethernet Port

The Ethernet port allows the user to transfer files to and from the switcher on the PC remotely. See [Chapter 3](#) for details on how you can utilize this port or perform system setup using this port.

TALLY

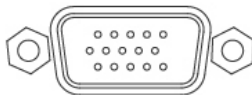

11. Tally Signal Output

Sends **Red**, and **Green** tally signals to each channel. **Red** indicates On-Air, and **Green** indicates next camera source.

SWITCHER F/W UPGRADE



12. USB Firmware Upgrade Port

Connect the USB drive containing the latest firmware files to this port and start the firmware upgrade process on the OSD MENU.

Note: Please refer to the section on [Firmware Update Procedure](#) for firmware upgrade details.

STREAM

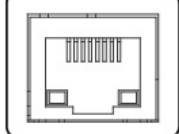

13. Stream Port

The Stream Port allows the user to connect the laptop to the HS-1300 directly to access the NVS-31 or connect the built-in NVS-31 to any IP network.

Note: Please refer to the [Video Streaming](#) section for device setup details.

2.2 Switcher Control Panel

User Memory and Function Keys

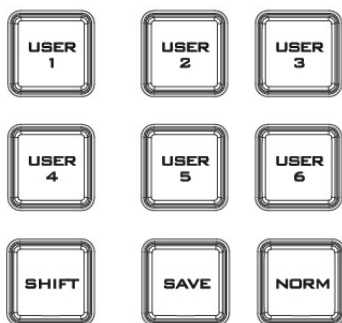

User Memory

User Memory buttons 1-6 allow the user to recall and load previously saved switcher settings.

SHIFT

There are 12 user memory locations. Under normal circumstances, Buttons USER 1 to 6 represent user memory locations 1 to 6. To load settings saved in locations 7 to 12 to buttons USER 1-6, simply press the **SHIFT** button.

SAVE: User Memory Save

The **SAVE** button saves the current switcher settings. To save, keep holding down this button and then select the User Memory number by pressing the corresponding User Memory button.

Normalise Button

The **NORM** button resets the currently opened menu item to the default values.

Menu Control

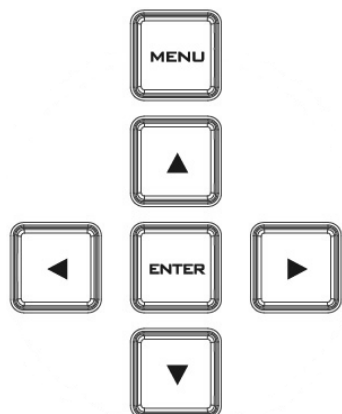

Menu Control

Press the **MENU** button in the HS-1300 function section to enter the System Configuration Menu. Press the **UP**, **DOWN**, **LEFT**, and **RIGHT** arrow buttons to browse the menu options and change values. Use the **ENTER** button to save and confirm any setting that has been changed. To Exit, simply press the **MENU** button again.

Keyer Selection



Key 1 PGM enables key 1 on the Multi view and PGM output

Key 2 PGM enables key 2 on the Multi view and PGM output

DSK 1 PGM enables DSK 1 on the Multi view and PGM output

DSK 2 PGM enables DSK 2 on the Multi view and PGM output

Key 1 PVW enables key 1 on the Multi view and PVW output

Key 2 PVW enables key 2 on the Multi view and PVW output

DSK 1 PVW enable DSK 1 on the Multi view and PVW output

DSK 2 PVW enable DSK 2 on the Multi view and PVW output

Keyer Source

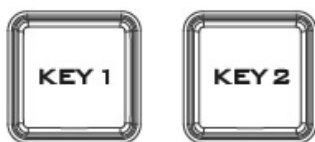

Selection of Keyer Source from Program / Preset Row

Keep holding down one of these buttons to enter key select mode and fill select mode. Select key source from the Program row and fill source from the Preset row.



The selected source button will flash.



KEYER SETUP

Press this button to open Keyer configuration menu on the Multi view output, and the opened configuration menu corresponds to the selected keyer (Key 1/Key 2/DSK 1/DSK 2).

DSK AUTO

Auto DSK transition function either transitions “DSK 1 or DSK 2 individually” or transitions “DSK 1 and DSK 2 simultaneously”

PIP Effect

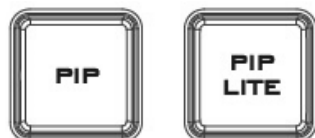

PIP enables the PIP key mode

PIP LITE enables the PIP LITE key mode

Background Transition & GRAB



TRANS BG enables Background Transition between Program / Preset

GRAB grabs the current Program video image to Input 6.

Wipe Border Setting

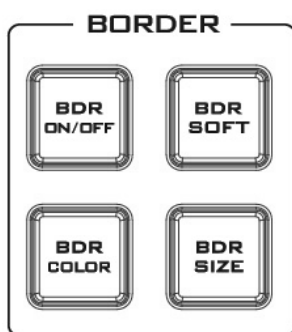

BDR ON/OFF turns the WIPE border function ON/OFF

BDR SOFT configures the WIPE border softness

BDR COLOR selects the WIPE border color

BDR SIZE adjusts the WIPE border thickness

Wipe Transition Selection

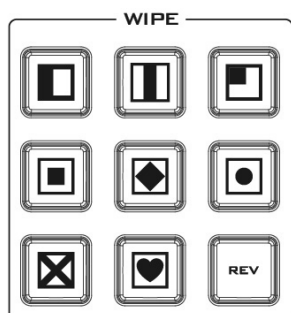

WIPE Transition Selection

The HS-1300 has 8 user defined wipe buttons that allow the user to select WIPE transition effect directly from the control panel.

The **REV** button reverses the direction of the selected WIPE.

All wipes can have an optional colour border applied. The wipe border width and colour are chosen within the menu system.

Transitions can be performed manually using the **T-Bar** or automatically by using the **SPEED** and **AUTO TAKE** buttons.



Vertical Wipe Left to Right



Vertical Wipes from Centre to Left and Right sides



Upper Left corner Wipe to Lower Right corner



Box Wipe from Centre to outside edges



Diamond Wipe from Centre to outside edges



Circle Wipe from Centre to outside edges



Cross Wipe from Centre to outside edges



Heart Wipe from Centre to outside edges

Program & Preview Source Row

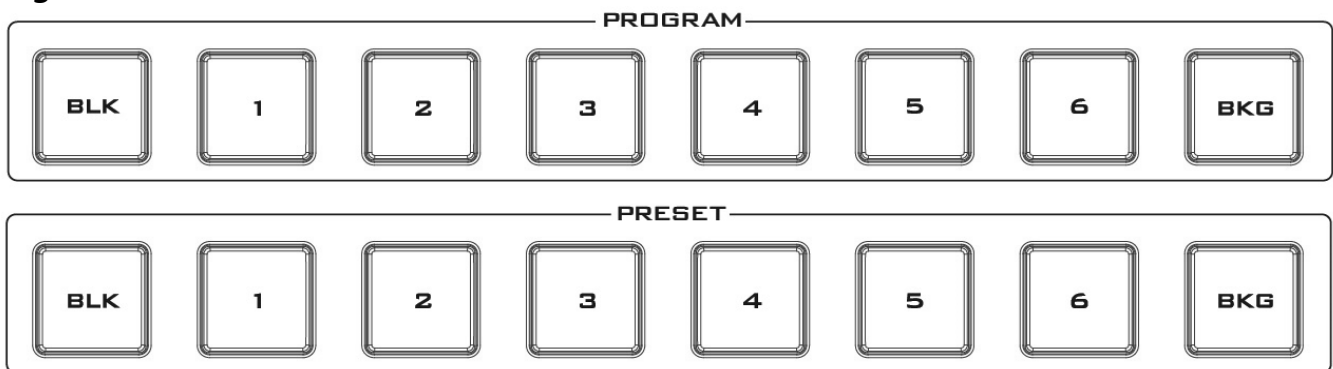

The Program row of buttons is the active channel, this is the live output. The active channel will appear as the Program Output. You can switch or CUT from one video source to another directly on the Program row. You will see the multi view Program output change as you press different keys along this top row of buttons.

The Preset row is the cued channel; this channel will appear in the Preview window. The Preset row selection decides which input will be transitioned next when using any of the transition controls.

Buttons 1, 2, 3, 4, 5 and 6 are video source buttons.



BLK

Black background – the black background, for use on the Program and Preset row.



BG

Background button – assigns a background colour or colour bars for use on the Program and Preset row.

Transition Effect



FTB

Fade To Black, this button fades the current video program source to black. When pressed again it acts in reverse from complete black to the currently selected program video source.

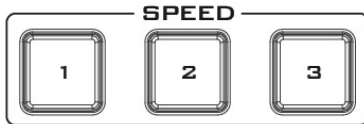

SPEED

There are three speed buttons which can be defined by the user. By pressing a speed button the user is choosing the rate of transition or time taken when using the AUTO TAKE button.

Transition Speed (1, 2 and 3):

Button 1= 12 frame duration, 2= 25 and 3= 50 at 1080i50

Button 1= 15 frame duration, 2= 30 and 3= 60 at 1080i60



PVW TRANS

Transition shown on PVW only.



MIX

This button enables MIX transition effect.



WIPE

This button enables WIPE transition effect. The WIPE button must be selected when a wipe effect transition between the selected Program and Preset sources is required. This WIPE effect is produced by moving the T-Bar manually or pressing the AUTO TRANS button.

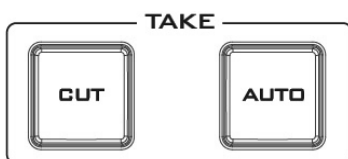

CUT

This performs a simple immediate switch from the current main source to the selected sub source. The selected transition wipe or MIX is not used.

AUTO TAKE

This performs an automated switch from the current program source to the selected Preview source. The selected transition wipe or MIX will also be used. The timing of the transition is set by the chosen Speed button.

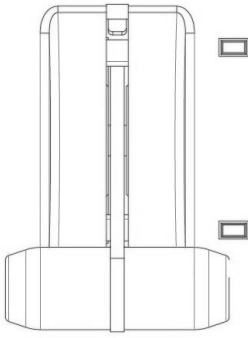

T-Bar

This performs a manually controlled transition from the current program source to the selected preset source. The selected transition wipe or dissolve will be used. When the T-Bar has travelled as far as it can go, the transition between sources is complete. The T-Bar has indicators next to it, which light when the transition is complete.

Audio Control

HEADPHONE 

Headphone Socket

1/4" / 6.3mm Stereo Headphone Socket for conventional headphones.

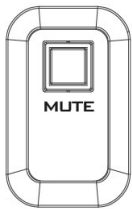

MUTE

This button mutes the headphone audio.



Headphone Volume Control

Controls Headphone or Headset volume level.

2.3 Monitor Control Panel

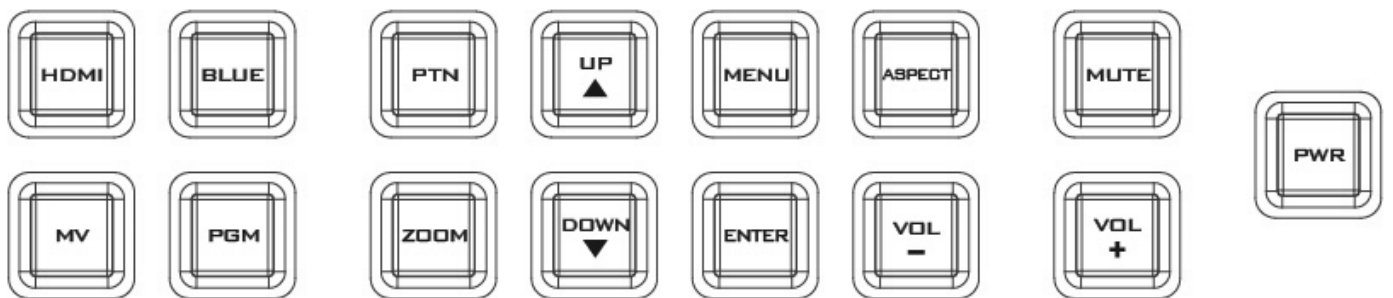

Power

Switches the HS-1300 Monitor Power ON / OFF

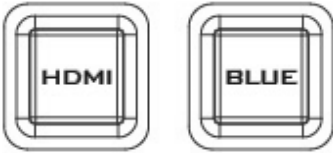

Source Select Buttons

Select the type of source you are using - HDMI, MV (multi-view), PGM (program).

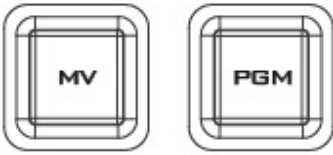

HDMI

Switch the 17.3" built-in monitor to display the video source plugged into the **MONITOR HDMI IN** port.

BLUE

Press this button to eliminate the red and green component of input signals. Only the blue component of an input is displayed on the screen.

MV

Press this button to set the Monitor to **MULTIVIEW** mode.

PGM

Press this button to set the Monitor to **PROGRAM** view.



PTN

When pressed displays internally generated SMPTE 75% Colour Bars. Press again to return to the previously selected video input.



ZOOM

This feature is designed for use with HD-SDI and HDMI sources above 720p resolution. Press this button to zoom in to the video on the display. This is strictly a zooming function and does not alter the native aspect ratio of the source pixels to fill the screen.

The **ZOOM** button allows you to toggle the Pixel Zoom feature between **zoom x1, x2, x4** and **x8**.

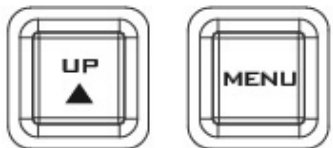

Menu Navigation Buttons

Display and navigate the set up menus - See [Monitor Menu Options](#) for more details.

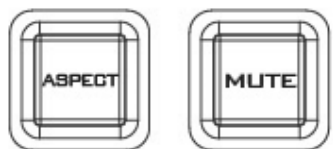
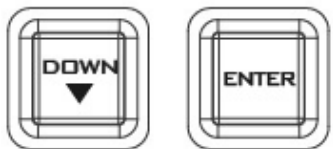

Aspect Ratio Button

Sets the Aspect Ratio to 16:9 / 4:3

Volume Control

Adjusts the speaker / headphone volume up / down.

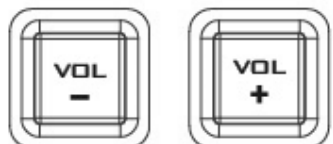

MUTE

Mutes the audio from the internal speakers or headphone socket.



RECORD

Press the RECORD button to start video recording.

STREAM

Press the STREAM button to start video streaming.



SD Card Slot

Insert an SD card into the SD card slot for video recording.

Note: Do not remove SD card while it is being written as doing so may result in corrupted video files.

Chapter 3 Network Setup

The Ethernet port on the back panel of the HS-1300 allows the user to import or export Stills/Clip files and User memory using the Switcher Image Import/Export software. The Switcher Image Import/Export software allows you to manipulate user memories, still pictures and clip files.

Section 3.1 discusses direct connection between the HS-1300 and your Windows computer. In Section 3.2, we will show you how you can remotely set up the Switcher Image Import/Export software with your switcher after it is installed on your Windows computer.

3.1 Switcher Setup with a Windows Computer

When new from the factory the HS-1300 will initially have a static IP address of 192.168.100.101. The unit can be directly connected to a Windows-based computer using an RJ-45 ethernet cable. The following set up should allow you to initially configure the unit before moving it to an existing DHCP / LAN network.

- An RJ-45 Ethernet cable.
- Windows 7/8/10 laptop or PC.
- The Datavideo Switcher Image Import/Export software.



Instructions

1. First connect the HS-1300 and the Windows computer together using an RJ-45 ethernet cable.
2. Turn on the Windows computer and set it to **static IP setup** within the **Windows Network and Sharing Centre**. In our example below the computer is given the following IP settings so that the computer matches the same IP range as the switcher.

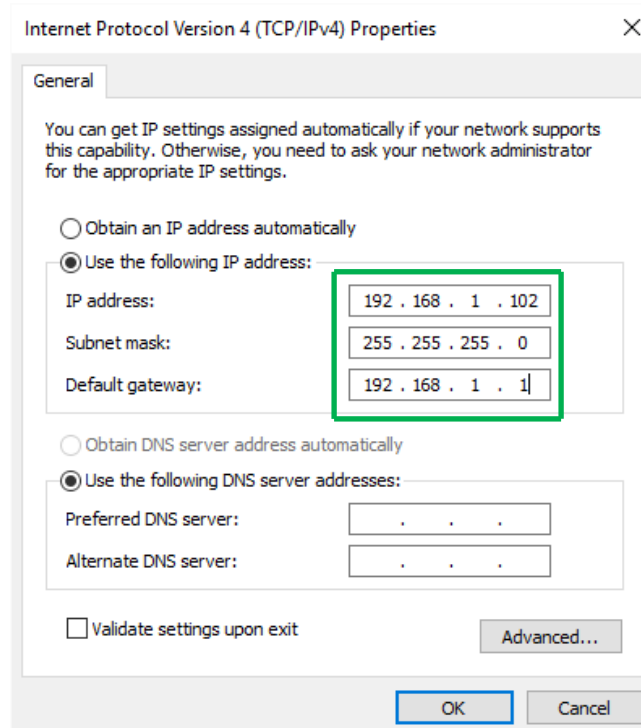

3. Now install the **Switcher Image Import/Export software** to the computer.

3.2 Installing the Switcher Image Import/Export software to a Windows Computer

The HS-1300 can be connected to a simple IP network and accessed using Windows-based software. If you have not already set up the HS-1300 with a computer then please follow the instructions in the previous section.



SwitcherImageImEx_v0975.msi

Please download the latest software from the Datavideo HS-1300 web page. See: www.datavideo.com

The install executable file [.msi] will be called **SwitcherImageImEx_vXXXX.msi**

The vXXXX represents the latest version number.

Double click this .msi file then **follow the on screen install wizard prompts.**

Once installed launch the **Switcher Image Import/Export software.**

The **Switcher Image Import/Export software** has a built-in IP finder, which is designed for PC with multiple Ethernet cards or DHCP network environment. Please note IP finder can only find devices that are on the same network domain as the PC. If you cannot remember your device IP, please press the **RESET** button to restore the default network settings. Upon launch of the **Switcher Image Import/Export software**, you will be prompted to select one Ethernet Interface Card.

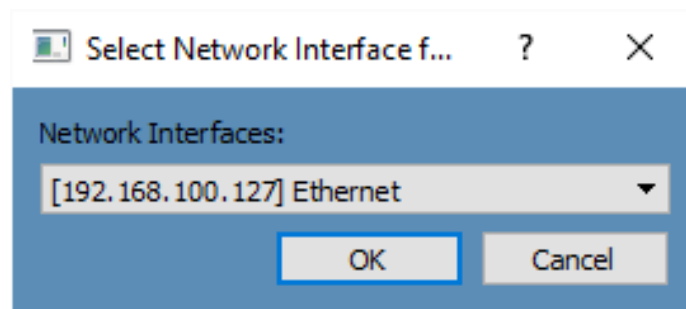

Once selected, click **OK** to start the scanning process.

Note: Please make sure the selected interface card is on the same network domain as the HS-1300 device.

Once the HS-1300 device is found, the software will connect with the switcher hardware over the IP set up described in the previous section. If the connection is successfully established, on the software user interface as shown in the diagram below, the **Connect Status** will show "**Connected**" (will display **Not Connected** if disconnected).

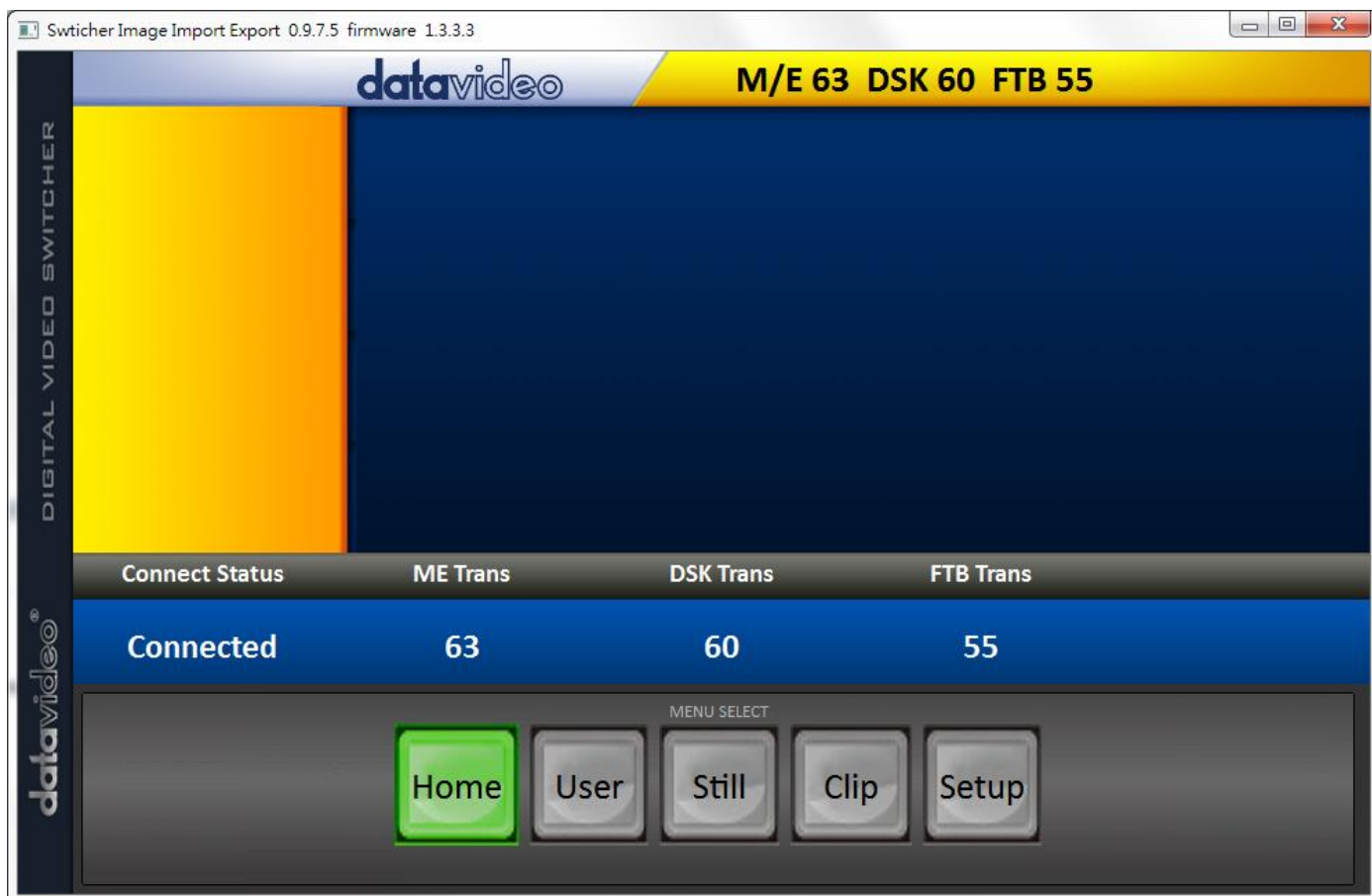

Router Based DHCP Setup

The computer software can also access the HS-1300 over an existing TCP/IP LAN type network. In order to initially set up the HS-1300, you may need the assistance of your local I.T. specialist to help with the network settings. To help guide you, we have included a simplified network setup example below, further advice may be available through your dealer locally or your Datavideo regional office.

To create this simple dedicated HS-1300 IP network you will need:

- An IP router which can assign/give IP addresses.
- Two RJ-45 patch leads.
- Windows 7/8/10 laptop or PC.
- The IP router Administrator login and password.
- The Datavideo Switcher Image Import/Export software.

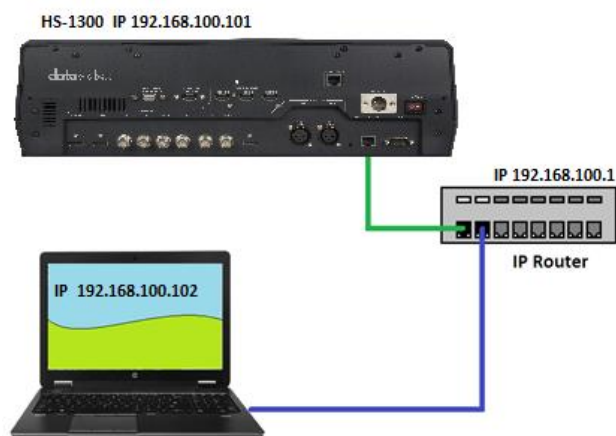
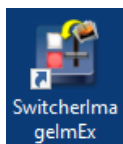

Instructions

1. First connect the router to the HS-1300 and the Windows computer using two RJ-45 patch leads.
2. Turn on the Windows computer and set it to **DHCP setup** within the **Windows Network and Sharing Centre**.
3. Now click the Windows start button and run the CMD prompt window.
4. At the command line > : _ type **IPCONFIG** and press enter.

5. The **DEFAULT GATEWAY** number displayed should be the router's current IP address.
6. Enter the **DEFAULT GATEWAY IP address** into the address bar of the computer's web browser.
7. The web browser should display the login window for the router. Enter the router's login and/or password.
The login details may be written on a sticker on the router itself or noted in the manual for the router.
8. Once logged into the router we need to change the router to supply IP addresses in the **192.168.100.xxx** range. Use the router's **LAN Setup** or **Configure LAN** option to set the router's IP address as **192.168.100.1** and click **save / apply**.
9. Now reboot the router and power ON the HS-1300.
10. Log into the router again using the web browser and the router's new IP address **192.168.100.1**
11. Use the router's **LAN Setup** or **Configure LAN** option again, within this option there should be another option called **Address Reservation** or **Client List**.
12. The two devices connected to the router should be listed here, the computer and the HS-1300.
13. The computer, because it is set for DHCP, will already have an IP address automatically assigned to it in this list.
14. The HS-1300 will also be listed with its default IP address of **192.168.100.101** if it is not changed.
15. Click **save / apply** then reboot the router again.
16. Close the web browser and CMD windows.
17. Now install the **Switcher Image Import/Export software** to the computer.

Setting the Target IP Address with the Switcher Image Import/Export Software

Click **Setup** button in the **MENU SELECT** pane and the current IP Network settings are shown alongside the software version.



If the network settings are wrong then you may not be able to access the HS-1300. Always keep a note of the last IP settings used and change these settings carefully to avoid problems.

Target IP address – This IP address is the location on the local network, or the internet, where the software can talk to the HS-1300. By clicking the **Target IP address** you can enter a new address, once entered click **Save Setup**. The next time the Image Import/Export Software is opened, it will try to contact the switcher on this new Target IP address.

Network – This option in the yellow menu column allows you to change the network options on the HS-1300. When delivered from the factory **the default static IP settings should be:**

Addr Mode: Static (a manually set IP address that does not change even after power cycling the HS-1300 unit)

Target IP address: 192.168.100.101

Network Mask: 255.255.255.0

Gateway: 192.168.100.1

DHCP Setup - If the IP set up method is changed to DHCP then each time the HS-1300 is started, it may be given a different IP address by the network. Only use this method if you know how to find the HS-1300 on the internal IP network. A device on the network (usually a router or server) will automatically assign an IP address to the HS-1300. The other settings such as IP address, Subnet Mask and Gateway may appear blank within the **Switcher Image Import/Export software** as these would be automatically set by network router/DHCP server.

Chapter 4 Switcher OSD MENU

4.1 Overview

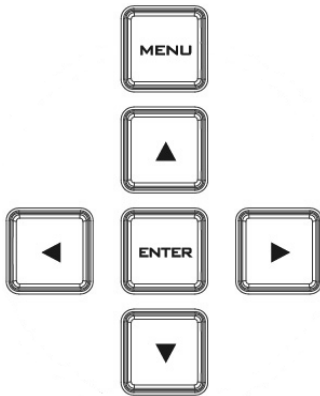

When the **MENU** button is pressed the Main Menu list is displayed on the HS-1300 monitor.

This section covers the Menu options in the order that they appear on the HS-1300 monitor. These settings may also appear in more detail elsewhere in this instruction manual. Options may vary depending on the firmware version in use.

Once the chosen setting has been confirmed with the **ENTER** button, it is stored within the switcher’s non-volatile memory.

Main Options	Sub-Options	Parameters	
Start	Transition (Duration)	M/E	Mix Effect
		DSK	Downstream Key Effect
		FTB	Fade-to-Black Effect
	Type	Clip	
		Wipe	
		Mix	
	Wipe Effects	Wipe	Wipe Effect Presets
		Soft	Border Softness
		Width	Border Width
	Border	Luma	Border Color Luma
		Sat	Border Color Saturation
		Hue	Border Color Hue
	Position	X	Horizontal Position
		Y	Vertical Position
Matte	Luma	Background Matte Luma	
	Sat	Background Matte Saturation	
	Hue	Background Matte Hue	
Keyer	Keyer	DSK 2 DSK 1 Key 2 Key 1	Keyer Selection
		Chroma Luma Linear	Type of Keyer
		P-in-P Lite P-in-P	P-in-P lite window enable P-in-P window enable
		Priority	Optional and only available when Key 1 and Key 2 are selected. Bot – Set to bottom layer Top – Set to top layer
	Keyer Ctrl	Lift	Parameter for dark/black areas of the overall foreground key image, ranging from -100% to +100%.
		Gain	Parameter for light/white areas of the overall foreground key image, ranging from 0 to 16.0

		Opac	Parameter for transparency of the overall foreground key image, ranging from 0% to 100%.
	Key Source	Bars Matte Input 6 Input 5 Input 4 Input 3 Input 2 Input 1 Black	Key Source Selections
		Fill	Fill Source Selection from Bars /Matte /Input 6 /Input 5 /Input 4 /Input 3 /Input 2 /Input 1 /Black
	Mask	Left	Left sets the left edge of the keyer mask
		Right	Right sets the right edge of the keyer mask
		Top	Top sets the top edge of the keyer mask
		Bottom	Bottom sets the bottom edge of the keyer mask
	Chroma	Keyer	DSK 2 (N/A) DSK 1 (N/A) Key 2 Key 1
Key Source		Bars Matte Input 6 Input 5 Input 4 Input 3 Input 2 Input 1 Black	Key Source Selections
		CK Setup	CK Auto
Hue			Parameter for color of the chroma key, ranging from 0 to 355.
Luma			Parameter for luma of the chroma key, ranging from 0 to 100%.
K Range			Setting the range of colors that match the background color to be keyed, ranging from 0 to 360.
K Fgnd			Adjusts the performance of the chroma key in dark or black areas, ranging from -100% to 100%.
K Bgnd			Adjusts the performance of the chroma key in light or white areas, ranging from K Fgnd value (min = 0) to 100%.
Hi-Light			Boosts the foreground key in high luminance area, ranging from 0 to 100%.
Lo-Light			Boosts the foreground key in low luminance area, ranging from 0 to 100%.
Bg-Supp			Bg-Supp turns ON/OFF background suppress
Mask		Left	Left sets the left edge of the keyer mask
		Right	Right sets the right edge of the keyer mask
		Top	Top sets the top edge of the keyer mask
		Bottom	Bottom sets the bottom edge of the keyer mask
P-in-P	P-in-P Src	Key 1 / Key 2	Select either Key 1 or Key 2 in the "Keyer" Option and enable P-in-P
	Position	X	Horizontal PIP Position

		Y	Vertical PIP Position	
		Size	PIP Size	
	Border	Luma	PIP Border Luma	
		Sat	PIP Border Color Saturation	
		Hue	PIP Border Color Hue	
		Width	PIP Border Width	
	Crop	Left	Left Edge of the Crop	
		Right	Right Edge of the Crop	
		Size	Size of the Crop	
		Top	Top Edge of the Crop	
		Bot	Bottom Edge of the Crop	
	P-in-P	Fine	Fine tune of parameters X/Y/Size with step size 0.1	
		Normal	Adjustment of parameters X/Y/Size with step size 1	
P-in-P Lite	P-in-P Keyer	Key 1 / Key 2	Select either Key 1 or Key 2 in the “Keyer” Option and enable P-in-P Lite	
	Position	X	Horizontal PIP Position	
	Border	Luma	PIP Border Luma	
		Sat	PIP Border Color Saturation	
		Hue	PIP Border Color Hue	
		Width	PIP Border Width	
	Crop	Left	Left Edge of the Crop	
		Right	Right Edge of the Crop	
		Size	Size of the Crop	
		Top	Top Edge of the Crop	
		Bot	Bottom Edge of the Crop	
	P-in-P Lite	Fine Normal	Fine tune of parameter X with step size 0.1 Adjustment of parameter X with step size 1	
	Inputs	Input 1	Black	Black Level
White			White Level	
Chrom			Chroma Level	
Input 2		Black	Black Level	
		White	White Level	
		Chrom	Chroma Level	
Input 3		Black	Black Level	
		White	White Level	
		Chrom	Chroma Level	
Input 4		Black	Black Level	
		White	White Level	
		Chrom	Chroma Level	
Freeze		1		Still Freeze Live
				Still Freeze Live
		2		Still Freeze Live
				Still Freeze Live
		3		Still Freeze Live
				Still Freeze Live
4		Still Freeze Live		
		Still Freeze Live		
5		Still Freeze Live		
		Still Freeze Live		
6		Still		

			Freeze Live
	Crosspoint	1	Input 6 Input 5 Input 4 Input 3 Input 2 Input 1 OFF
		2	Input 6 Input 5 Input 4 Input 3 Input 2 Input 1 OFF
		3	Input 6 Input 5 Input 4 Input 3 Input 2 Input 1 OFF
		4	Input 6 Input 5 Input 4 Input 3 Input 2 Input 1 OFF
		5	Input 6 Input 5 Input 4 Input 3 Input 2 Input 1 OFF
		6	Input 6 Input 5 Input 4 Input 3 Input 2 Input 1 OFF
Outputs	Output	SDI1/ SDI2	Input 6 Input 5 Input 4 Input 3 Input 2 Input 1 CLN PVW (Clean PVW) CLN PGM (Clean PGM) PG + DSK PVW PGM

			MultiV (Multi view)	
		HDMI (17.3" Built-in Monitor Resolution)	1080i 1080p	
	Audio	Mode		ON/OFF
		Src		Input 6 Input 5 Input 4 Input 3 Input 2 Input 1 Follow External
		SDI 1		SDI 1 Audio Enable (ON)/Disable (OFF)
		SDI 2		SDI 2 Audio Enable (ON)/Disable (OFF)
		HDMI (17.3" Built-in Monitor)		HDMI Audio Enable (ON)/Disable (OFF)
		Tally Mode	Audio Mixer	
	Normal			
	GPI Out			GPI Enable/Disable
		Mode		Level/Pulse
		Width		Pulse width
		Input 1-6		GPI-out assignment
		Delay		0-99
	Multiviewer	AutoNum		Auto number input labels (ON/OFF)
		Label Inf		Input label is followed by information which describes the input as still, live or frozen image (ON/OFF)
		Trns Lab		Turn the background of the label from a solid colour to transparent (ON/OFF)
	Stills	Load Still	Load	Pressing this button loads the selected still picture source
			Still Memory Location	0-500
			Destination	Input6 Input5 Input4 Input3 Input2 Input1
Thumbnail Picture - 1			Preview of the previous image	
Thumbnail Picture			Preview of the image to be loaded	
Thumbnail Picture + 1			Preview of the next image	
Save Still			Save	
		Source		Input6 Input5 Input4 Input3 Input2 Input1
		Still Memory Location		0-500
Grab Still		Grab		Press this button to grab the current program view
		Grab Destination		Input6 Input5 Input4 Input3 Input2 Input1

	Freeze	1	Sets the Frame store mode of Input 1 to Clip / Still / Freeze / Live
		2	Sets the Frame store mode of Input 2 to Clip / Still / Freeze / Live
		3	Sets the Frame store mode of Input 3 to Clip / Still / Freeze / Live
		4	Sets the Frame store mode of Input 4 to Clip / Still / Freeze / Live
		5	Sets the Frame store mode of Input 5 to Clip / Still / Freeze / Live
		6	Sets the Frame store mode of Input 6 to Clip / Still / Freeze / Live
User Mem	Load Mem	Memory	Memory Selection from 1 to 999
		Load	Selection of this button loads the selected memory
	Save Mem	Memory	Memory Selection from 1 to 999
		Save	Selection of this button saves to the selected memory
	Load Clip	Load	Selection of this button loads the selected clip
		Clip Memory Location	Memory locations from 0 to 999
		Thumbnail Clip - 1	Preview of the previous clip
		Thumbnail Clip	Preview of the clip to be loaded
Thumbnail Clip + 1		Preview of the next clip	
Clear Clip		Clear the loaded clip	
	Delete Clip	Remove the clip from the memory location	
Setup	Standard	1080i/50	Resolution Selections from 1080i/50/59.94/60 720p/60/59.94/50
		Save Setup	Saves the selected resolution
	Audio	Level	EBU SMPTE AUTO
	Menu Mode	Advanced	Full
		Basic	Reduced
	Menu Pref	Blue / Grey	Selection of menu color
		Transp	Menu transparency level of 0/1/2
		Size	Menu size of Normal/Small/Large
	Menu Pos	Bottom Right Left Top Centre	This option sets the menu position
	Auto Save	ON / OFF	Automatically saves the last settings before the machine is shut down; once turned ON auto save also occurs upon every Still Load.
	Factory Def	Reset	Factory Default Reset loads the default configuration from memory point 0 for all configuration options except for the Setup.
		Reset Names	Resets the Multiviewer labels to the default settings
		Network Default	Resets the network settings
	Language	English Traditional Chinese Simplified Chinese	
	Software	Upgrade	This starts the FW upgrade process Please refer to the Firmware Upgrade section for the USB firmware update process.

4.2 Functions

The HS-1300 HD 6-Channel Portable Video Studio offers the user an OSD menu to perform several image effect configurations, such as Picture-in-Picture, keyers, downstream keys, still pictures and etc. The user can also configure the I/O by selecting the Inputs and Outputs options. In addition, under the setup options, the user is allowed to set the menu color, size, position and language.

The OSD Menu also gives the user the flexibility to switch between basic and advanced modes. The basic mode is generally a condensed version of the advanced menu mode. The following sections will show you the options available in these two modes.

Start

The “**Start**” option generally allows the user to set the Transition duration, the Transition type, and various WIPE effect parameters. The OSD menu display is illustrated in the table below.

Advanced Mode

Start	Transition	M/E	60	DSK	60	FTB	60
	Type	Wipe					
	Wipe Effects	Wipe	1	Soft	0%	Width	0%
	Border	Luma	100%	Sat	80%	Hue	178
	Position	X	0%	Y	0%		
	Matte	Luma	100%	Sat	80%	Hue	0
Ip Addr: 192.168.100.101							

Basic Mode

Start	Transition	M/E	60	DSK	60	FTB	60
	Wipe Effects	Wipe	1	Soft	0%	Width	0%

Transition

The transition option allows the user to set the transition duration, in frames, for switching to the PGM view when using the **AUTO**, **DSK** and **FTB** buttons. The sub-options are (AUTO) Mix Effect (**M/E**), Downstream Key (**DSK**) and Fade-To-Black (**FTB**). If the M/E is set to a value of 50 then the transition will take effect over a period of 50 frames or roughly 2 seconds. When the **AUTO button** is pressed, the transition will take the current M/E value.

Wipe Effects

This sub-option allows the user to select the desired Wipe Transition Effect and configure the wipe’s border softness and width.

- **Wipe** – Wipe Effect Selection.
- **Soft** – A low value results in a solid edge border and a high value gives a soft diffused border.
- **Width** – A low value results in a thin border and a high value gives a wide border.

Border

After selecting this sub-option, the user will then be allowed to fine-tune the border color by adjusting the Luma, Saturation and Hue values, i.e. Luma, Sat and Hue.

Position

Position allows the user to adjust the centre position of some wipes (e.g Circle & Ellipse). X represents the horizontal position and Y represents the vertical position.

X	Y
Positive value: position the wipe centre to the right	Positive value: move the wipe centre up
Negative value: position the wipe centre to the left	Negative value: move the wipe centre down
Zero value: Position the wipe centre at the screen centre	Zero value: Position the wipe centre at the screen centre

Matte

The user can configure the Matte Luma, Saturation and Hue under this sub-option.

IP Address

The displayed IP address allows the user to connect to the switcher from a remote location where network connection is available.

Keyer

In this option, the user is able to configure four keyers, which are **Key 1**, **Key 2**, **DSK 1** and **DSK 2**.

Advanced Mode = Basic Mode

Keyer	Keyer	Key 1			
	Keyer Ctrl	Chroma	P-in-P	Priority	Bot
		Lift 0%	Gain 1.0	Opac	100%
	Key Source	Input 1	Fill Input 3		
	Mask	Left 0%	Right 0%		
		Top 0%	Bot 0%		

Keyer Control

There are three keying modes available: **Linear**, **Luma**, and **Chroma**.

After the keying mode is chosen, if only one source is enabled for the keyer, select the source in **Key Source**. If two sources are enabled for the keyer, select the respective sources in **Key** and **Fill Sources**. You may also select **P-in-P** or **P-in-P Lite** to apply the keying effect to the P-in-P window.

Please note:

If Luma is selected, fine tune the Luma Keyer parameters (Lift, Gain and Opac) in the Keyer option.

If Chroma is selected, fine tune the Chroma Keyer parameters in the Chroma option.

If P-in-P is selected, fine tune its parameters in the P-in-P option.

If P-in-P Lite is selected, fine tune its parameters in the P-in-P Lite option.

For example, if the user selects **Key 1** → **Chroma** → **P-in-P**, you will be performing chromakeying of the P-in-P image after the relevant chroma keyer parameters are adjusted in the **Chroma** option.

Priority sets the key image to either the top layer or bottom layer and is only available if **Key 1** or **Key 2** is selected.

The Keyer Control also allows the user to adjust lift, gain and opacity of the key image.

Lift adjusts the dark/black areas of the key image.

Gain adjusts the light/white areas of the key image.

Opacity adjusts the transparency of the overall foreground key image.

Key Source

This sub-option allows the user to assign the key source; various options are listed below:

Bars	Matte	Input6	Input5	Input4	Input3	Input2	Input1	Black
------	-------	--------	--------	--------	--------	--------	--------	-------

Fill Source

This sub-option allows the user to assign the fill source if **Split** is selected; various options are listed below:

Bars	Matte	Input6	Input5	Input4	Input3	Input2	Input1	Black
------	-------	--------	--------	--------	--------	--------	--------	-------

Mask

The Mask feature allows the user to configure the Mask in chroma, luma or linear mode.

- **Left** – Left sets the left edge of the keyer mask.
- **Right** – Right sets the right edge of the keyer mask.
- **Top** – Top sets the top edge of the keyer mask.
- **Bottom** – Bottom sets the bottom edge of the keyer mask.

Chroma

In this option, the user will be able to find all the parameters needed to perform chromakeying of the green backdrop.

Advanced Mode = Basic Mode

Chroma	Keyer	Key 1					
	Key Source	Input 5					
	CK Setup	CK Auto	Hue	120	Luma	100%	
		KRange	170	K Fgnd	15%	K Bgnd	67%
		Hi-Light	0%	Lo-Light	0%	Bg-Supp	On
	Mask	Left	0%	Right	0%		
		Top	0%	Bot	0%		

Keyer

First of all, select the **Keyer** that you would like to enable for the chromakeyer (**Key 1**, or **Key 2**) and then select one Key Source from all available **Key Sources** listed in the table below.

Bars	Matte	Input6	Input5	Input4	Input3	Input2	Input1	Black
------	-------	--------	--------	--------	--------	--------	--------	-------

CK Setup

In this sub-option, the user will be able to fine tune various chroma keyer parameters.

CK Auto: This function calculates the best Hue & Luma values for the current Key Source.

Hue: This parameter adjusts the color of the chroma key. A typical green screen value will be around 120. Blue screen value will be around 240.

Luma: This parameter adjusts the luma value of the chroma key

Key Range (KRange): Key Range sets the range of hues or colors (0 – 360 degrees) that closely match the background color to be keyed. The user can start with a value of 120 degrees and this value can be fine-tuned up or down depending on the setup of the green or blue screen studio.

Key Foreground (K Fgnd): Key Background adjusts the performance of the chroma key in light or white areas. Increase the value if the light areas are becoming too transparent.

Key Background (K Bgnd): Key Foreground adjusts the performance of the chroma key in dark or black areas. Increase the value if the dark areas are becoming too transparent.

Hi-Light: Hi-light boosts the foreground key in high luminance area.

Lo-Light: Lo-light boosts the foreground key in low luminance area.

Bg-Supp: Background Suppress removes the Luma (Brightness) of the background from the final image. Bg-Supp turns ON/OFF background suppression.

Mask

The Mask feature allows the user to configure the Mask in chroma mode.

- **Left** – Left sets the left edge of the Chroma keyer mask.
- **Right** – Right sets the right edge of the Chroma keyer mask.
- **Top** – Top sets the top edge of the Chroma keyer mask.
- **Bottom** – Bottom sets the bottom edge of the Chroma keyer mask.

P-in-P

P-in-P option allows the user to adjust all related P-in-P parameters. Enter this option if the user selects **P-in-P** in the **Keyer Ctrl** sub-option of the **Keyer** option. “**P-in-P Scr**” sub-option indicates the keyer enabled for P-in-P. In our example below, the **Key 1** keying effect will be applied to the P-in-P window.

Please note that the “**P-in-P Scr**” sub-option can only be changed in the **Keyer** option.

Advanced Mode = Basic Mode

P-in-P	P-in-P Src	Key 1					
	Position	X	20%	Y	10%	Size	50%
	Border	Luma	0%	Sat	0%	Hue	0
		Width	0%				
	Crop	Left	0%	Right	0%	Size	0%
		Top	0%	Bot	0%		
	P-in-P	Fine					

Position

The user can adjust the P-in-P window position by adjusting values of **X**, **Y** and **SIZE**, where X is the horizontal position, Y is the vertical position and Size is the P-in-P window size.

- X-Value**
- Positive value: position the P-in-P window to the right.
 - Negative value: position the P-in-P window to the left.
 - Zero value: Position the P-in-P window at the center.

Y-Value Positive value: move the P-in-P window up.
 Negative value: move the P-in-P window down.
 Zero value: Position the P-in-P window at the center.

Size Ranges from 0 to 100 with 1% being the smallest and 100 being the largest. So 50% would represent a P-in-P window which is half the size of the background image. 100% would see the PIP image totally cover the background image unless offset to one side.

Border

P-in-P window border color can be set by adjusting the **Luma**, **Saturation** and **Hue** values. **Luma** and **Saturation** have a range between 0-100% and **Hue** lies between 0-355.

Border Width

The “**Width**” sub-option adjusts the border width. A width of zero (0) will turn the P-in-P window border off.

Crop

The P-in-P window crop can be adjusted by modifying the following parameters:

- **Left** – Adjusts the position of the left edge of the P-in-P window.
- **Right** – Adjusts the position of the right edge of the P-in-P window.
- **Size** – Adjusts the P-in-P window crop size.
- **Top** – Adjusts the position of the top edge of the P-in-P window.
- **Bot** – Adjusts the position of the bottom edge of the P-in-P window.

P-in-P

In this sub-option, the user is allowed to switch between **FINE** and **NORMAL** modes. In FINE mode, the parameters X, Y and Size can be finely tuned with step size 0.1. In NORMAL mode, the parameters X, Y and Size are adjusted with step size 1.

P-in-P Lite

P-in-P Lite option allows the user to adjust related P-in-P parameters **EXCEPT** its vertical position and the **P-in-P** window size. Enter this option if the user selects **P-in-P Lite** in the **Keyer** option. “**P-in-P Keyer**” sub-option will indicate the keyer enabled for P-in-P Lite. In our example below, the **Key 1** keying effect will be applied to the P-in-P Lite window.

Please note that the “**P-in-P Keyer**” sub-option can only be changed in the **Keyer** option.

Advanced Mode = Basic Mode

P-in-P Lite	P-in-P Keyer	Key 1			
	Position	X	-22%		
	Border	Luma	100%	Sat	80%
		Width	2%		Hue 0
	Crop	Left	32%	Right	22%
		Top	2%	Bot	24%
	P-in-P Lite	Fine			

Position

The user can adjust the horizontal position of the P-in-P window by adjusting the **X** value.

- Positive X value positions the P-in-P window to the right.
- Negative X value positions the P-in-P window to the left.
- Zero X value positions the P-in-P window at the center.

Border

P-in-P window border color can be set by adjusting the **Luma**, **Saturation** and **Hue** values. Luma and Saturation range from 0-100%, whereas Hue ranges from 0-355. The “**Width**” sub-option adjusts the border width. A width of zero (0) will turn the P-in-P window border off.

Crop

The P-in-P window crop can be adjusted by modifying the following parameters:

- **Left** – Adjusts the position of the left edge of the P-in-P window.
- **Right** – Adjusts the position of the right edge of the P-in-P window.
- **Size** – Adjusts the P-in-P window crop size.
- **Top** – Adjusts the position of the top edge of the P-in-P window.
- **Bot** – Adjusts the position of the bottom edge of the P-in-P window.

P-in-P Lite

In this sub-option, the user is allowed to switch between **FINE** and **NORMAL** modes. In FINE mode, the parameters X can be finely tuned with step size 0.1. In NORMAL mode, the parameters X is adjusted with step size 1.

Inputs

This feature allows the user to configure the color of the Inputs 1-4. In addition, the user can shuffle the contents of Inputs 1-6 without changing the hardware connections at the back of the machine. The user can also select the input source from Clip, Still, Freeze and Live.

Advanced Mode

Inputs	Input 1	Black	0%	White	100%	Chrom	1.0
	Input 2	Black	0%	White	100%	Chrom	1.0
	Input 3	Black	0%	White	100%	Chrom	1.0
	Input 4	Black	0%	White	100%	Chrom	1.0
	Freeze	1	Still	2	Live	3	Still
		4	Still	5	Still	6	Live
	Crosspoint	1	Input 1	2	Input 2	3	Input 3
		4	Input 4	5	Input 5	6	Input 6

Basic Mode

Inputs	Freeze	1	Still	2	Live	3	Still
		4	Still	5	Still	6	Live
	Crosspoint	1	Input 1	2	Input 2	3	Input 3
		4	Input 4	5	Input 5	6	Input 6

Input 1-4

By selecting the corresponding input (Inputs 1-4), the user will then be allowed to configure the colour of the inputs 1-4 by adjusting its Black Level, White Clip and Chroma Gain parameters.

Freeze

“Freeze” allows the user to load an image to **Inputs 1-6** from one of the four sources listed as follows:

- Still
- Freeze
- Live

Crosspoint

In this sub-option, the user can shuffle the contents of Inputs 1-6 without changing the hardware connections at the back of the machine, or even assign multiple inputs to the same source. For example, the user is allowed to assign the input 2 video source to input 1, after which the input 2 video will also be displayed on the input 1 window.

Outputs

This option allows the user to configure various output settings such as video output, audio output, and GPI Out.

Advanced Mode

Outputs	Output	Sdi 1	Pgm	Sdi 2	Input 2	HDMI	1080P
	Audio	Mode	On	Src	Follow		
		Sdi 1	On	Sdi 2	On	HDMI	On
	Tally Mode	Audio Mixer					
	GPI Out		Off	Mode	Pulse	Width	1
			Input 1	Delay	0		
	MultiViewer	AutoNum	Off	Label Inf	Off	Trns Lab	Off

Basic Mode

Outputs	Output	Sdi 1	Pgm	Sdi 2	Input 2	HDMI	1080P
	Audio	Mode	On	Src	Follow		
		Sdi 1	On	Sdi 2	On	HDMI	On

Outputs

In general, the two SDI output ports (**SDI 1 and SDI 2**) located on the rear panel as well as the 17.3” built-in monitor (**HDMI**) can be configured to output one of the following:

- Input 6
- Input 5
- Input 4
- Input 3
- Input 2
- Input 1
- CLN PVW (Clean PVW)
- CLN PGM (Clean PGM)
- PG + DSK
- PVW
- PGM
- MultiV (Multi view)

In addition to selecting your output source, you are also allowed to set two different resolutions for the **17.3” built-in monitor**. The two available resolutions are 1080i and 1080p.

Audio

The Audio sub-option for the SDI and HDMI outputs allows the user to individually turn ON/OFF the embedded audio component for the **17.3" built-in monitor (HDMI)** and at the **SDI1 and SDI2 output ports (Sdi1 / Sdi 2)**.

Mode (On/Off): The HS-1300 can only accept external audio using the analogue XLR inputs on the rear panel. Ideally a master audio mixer would be used alongside the HS-1300. A Datavideo AM-100 or AD-200 could be considered. By changing the Audio sub option from ON to OFF will mute the incoming XLR audio from the external master audio mixer.

Level (EBU/SMPTE/AUTO): There are two different audio standards available for selection. The user can either select the EBU or SMPTE standard. By selecting AUTO allows the device to automatically detect the audio standard.

Tally Mode

In this sub-option, the user will be allowed to switch to either the **Audio Mixer** or the regular tally light connection (**Normal**).

GPI Out

This allows the user to perform GPI configuration. After turning on the GPI, select the GPI **mode**, which is either level or pulse. The pulse width can also be configured in the sub-option **Width (1-9)**. GPI out can then be assigned to one of Inputs 1-6 and the **delay** can be set to between 0 and 99. This feature could be used to trigger playback from an external playback device such as Datavideo's NVP-20 or HRS-30 unit.

Multiviewer

AutoNum: The Multiview windows can be automatically numbered, and this sub-option turns ON/OFF automatic numbering.

Label Inf: This sub-option turns ON/OFF Label information. Input label is followed by information which describes the input as still, live or frozen image.

Trns Lab: This sub-option turns ON/OFF Label Transparency. Once enabled, the background of the label is then turned from a solid colour to transparent.

Stills

Still allows the user to load images from the memory, save images to the memory, and save the images captured.

Advanced Mode

Stills	Load Still	Load	Still Num	13	Input 5
		Thumbnail Picture - 1	Thumbnail Picture		Thumbnail Picture + 1
	Save Still	Save	Input 5	Still Num	13
	Grab Still	Grab	Input 3		
	Freeze	1 Still	2 Live	3 Still	
		4 Still	5 Still	6 Live	

Basic Mode

Stills	Load Still	Load	Still Num	13	Input 5
		Thumbnail Picture - 1	Thumbnail Picture		Thumbnail Picture + 1
	Save Still	Save	Input 5	Still Num	13

Load Still

Upon selecting “Load Still”, the user can then choose the memory location from which the still image is loaded. The following are the destinations to which the still image can be loaded:

- **Input 6**
- **Input 5**
- **Input 4**
- **Input 3**
- **Input 2**
- **Input 1**

Select “Load” to load the still image to the determined destination.

Image Preview is available below the “Load Still” row. “**Image Preview – 1**” allows the user to preview the previous image, “**Image Preview**” displays the image that will be loaded when “**Load**” is selected, and “**Image Preview + 1**” shows the next image.

Save Still

“**Save Still**” allows the user to save the still image to a specific memory location. The user should determine the source of the still image first. The available sources are listed below:

- **Input 6**
- **Input 5**
- **Input 4**
- **Input 3**
- **Input 2**
- **Input 1**

To complete the save, the user can simply select “**Save**” after determining the memory location.

Grab Still

In this sub-option, select “**Grab**” to capture the current program view and save it to Grab Destination (Input 1 to Input 6).

Freeze

“Freeze” allows the user to load an image to **Inputs 1-6** from one of the four sources listed as follows:

- **Clip**
- **Still**
- **Freeze**
- **Live**

User Mems

In this option, the user is allowed to **load** previously saved settings and **save** the currently configured settings.

Advanced Mode = Basic Mode

User Mems	Load Mem	Memory	1	Load	
	Save Mem	Memory	1	Save	
	Load Clip	Load	Clip	1	
		Thumbnail Clip – 1	Thumbnail Clip	Thumbnail Clip	Thumbnail Clip + 1
		Clear Clip		Delete Clip	

Load Memory

Use the up/down arrow to scroll to the desired memory location (1-999) and load the saved setting by selecting “Load”. The user can also press one of the USER memory shortcut buttons (1-6) on the control panel as a quick way of loading those previously saved User configurations.

Save Memory

Use the up/down arrow to scroll to the desired memory location and save the current setting by selecting “Save”

Load Clip

Before loading the clip, the user should first choose the clip location where the video clip is saved. The following are the buffer destinations to which the video clip can be loaded:

- **Input 6**
- **Input 5**
- **Input 4**
- **Input 3**
- **Input 2**
- **Input 1**

Select “Load” to load the selected video clip to the configured destination.

Clip Preview is available below the “Load Clip” row. “Thumbnail Clip – 1” allows the user to preview the previous clip, “Thumbnail Clip” displays the clip that will be loaded when “Load” is selected, and “Thumbnail Clip + 1” shows the next clip.

To clear the loaded clip from the buffer, simply select “Clear Clip.” To remove clip from a memory location, select “Delete Clip.”

Setup

In the “Setup” menu, the user can change the **resolution**, switch between full and simplified menu versions, adjust the **menu preferences**, enable/disable **Auto Save**, reset the machine to its **Factory Default** settings, choose the preferred OSD menu **language**, **upgrade firmware** and view the **current firmware versions** (Interface, Mainboard and Keyboard).

Setup	Standard	1080i/59.94	Save Setup	
	Audio	Level Auto		
	Menu Mode	Advanced		
	Menu Pref	Blue	Transp 1	Size Normal
	Menu Pos	Centre		
	Auto Save	On		
	Factory Def	Restore	Restr Names	Network Def
	Language	English		
	HS-1300	S/W: v1.4.0.1	F/W: 2017-08-14	KBD: v2.27

Audio Level (EBU/SMPTE/AUTO)

There are two different audio standards available for the user to select. The user can either select the EBU or SMPTE standard. By selecting AUTO, the device will be allowed to automatically detect the audio standard.

Menu Preference

In menu preference, the user is allowed to set the menu color, menu transparency level, menu size and the display position.

Menu color: the available colors are blue and grey

Options of **Menu Transparency** are listed below:

0: No Transparency

1: Background 50% Transparent (buttons not Transparent)

2: All Menu 50% Transparent

Menu Size

The menu size options are:

1. Normal

2. Small (1080i Mode)

3. Large (720p Mode)

Menu Position

Menu Position gives the user ability to select several positions for the Menu area on the Screen. The current options are Centre, Top, Left, Right and Bottom.

Standard

This option allows the user to choose the appropriate output resolution such as 1080i/50. Once done, simply select “**Save Setup**” to confirm the selected output resolution. The available resolutions are 1080i/50/59.94/60, 720p/60/59.94/50.

Menu Mode

The user is allowed to switch between full and simplified menu versions. Select “Advanced” for full menu display or “Basic” to display a simplified version of the OSD menu.

Auto Save

When enabled, your last settings will be automatically saved before the machine is shut down. At the next boot, the machine will automatically load the last saved settings. In addition, a Still Load will cause the auto save to occur.

Factory Default

Reset: This option resets the machine to the factory default settings by loading the default configuration from memory point 0 for all configuration options except for the **Setup**.

Reset Names

This resets the Multiviewer labels (Inputs 1-6) to their default settings.

Network Default

Network Default resets the device’s network settings.

Language

The available languages for OSD menu are English, Traditional Chinese and Simplified Chinese.

Software

This option is only available when the USB storage device containing the latest firmware file is inserted. Select Upgrade to start the firmware upgrade process. Refer to the [FIRMWARE UPDATE](#) section for more details.

At the bottom of the menu, you will be able to view the version number of the latest firmware installed.

Chapter 5 Video Streaming

The HS-1300 Portable Video Studio includes a built-in Video Streaming Server (NVS-31) allowing the user to stream and record your program at the same time. From any HDMI input source, the Datavideo NVS-31 generates an H.264 encoded stream compliant with RTSP or RTMP protocols. While encoding the video at bit rates appropriate for live streaming, the Datavideo NVS-31 concurrently records a high-quality MP4 file to an SD card.

5.1 Network Connection and Setup

This section details how to connect the NVS-31 to a network with or without a DHCP server, and describes how to acquire the NVS-31 IP address.

Finding the NVS-31's current IP address



You must first know your NVS-31 device's IP address to access the Web User Interface. Datavideo provides a free Windows based utility called IP Finder to search for devices connected on the same network.

On the computer connected to the NVS-31, first download the utility from the product page of HS-1300. Once downloaded, locate and double click the icon on the left to open the utility shown in the diagram below.

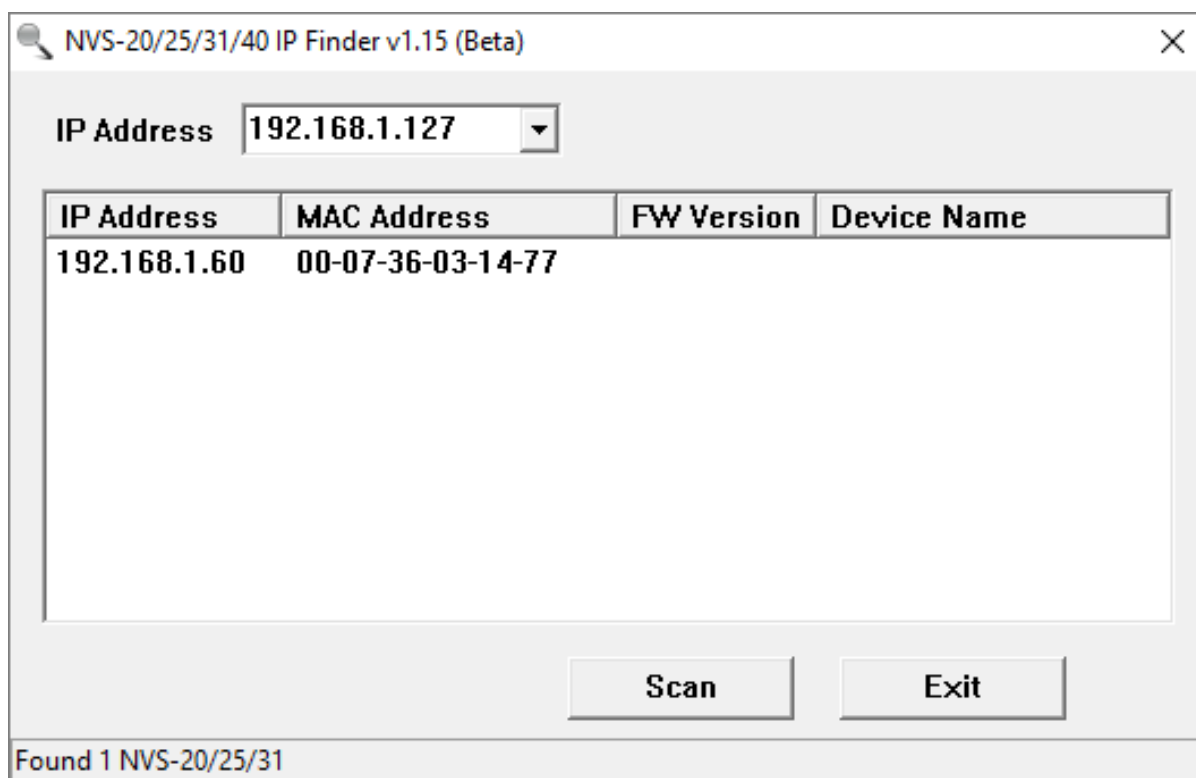

Please note that in order for your computer to communicate with the NVS-31, your computer's IP address must be in the same network range as your NVS-31's IP address. In the above example, change your computer's IP address and subnet mask to the following:

IP address 192.168.1.X

Subnet mask 255.255.0.0

There are basically two ways to establish connection between the NVS-31 and your computer:

- Connect an Ethernet cable from the NVS-31's LAN port directly to your computer's Ethernet port.
- Connect an Ethernet cable from the NVS-31's LAN port to the same network switch as your computer.

Note: If the first method is chosen, make sure to manually assign an IP address to your PC before making attempts to connect to the NVS-31.

5.2 Web User Interface

By now, we have obtained the IP addresses of the computer and the NVS-31. Type the NVS-31's IP address into the address bar of a browser and then hit the **ENTER** button. Login by entering the user name as well as the password into a pop-up dialogue box as shown below.

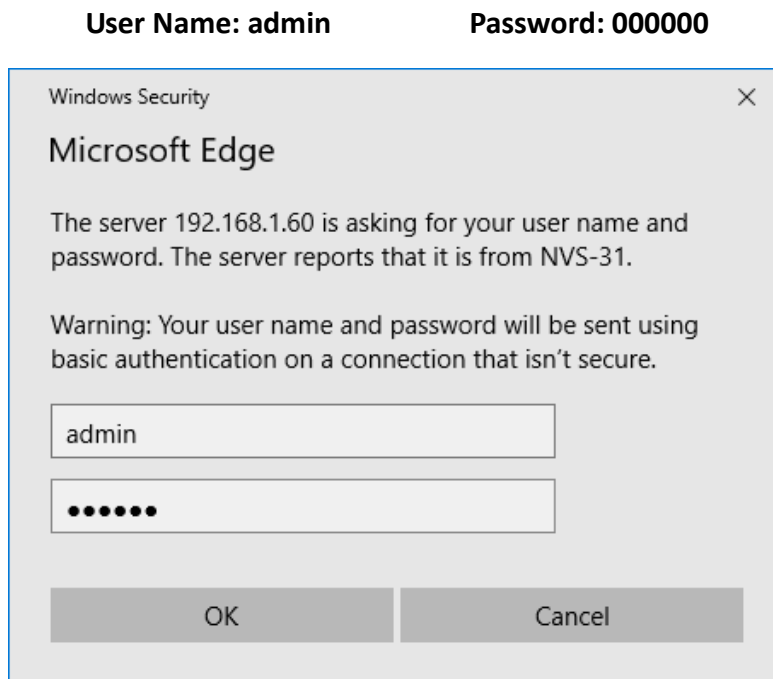

Click **OK** button to login and you will be directed to the **Source** Page as shown below.

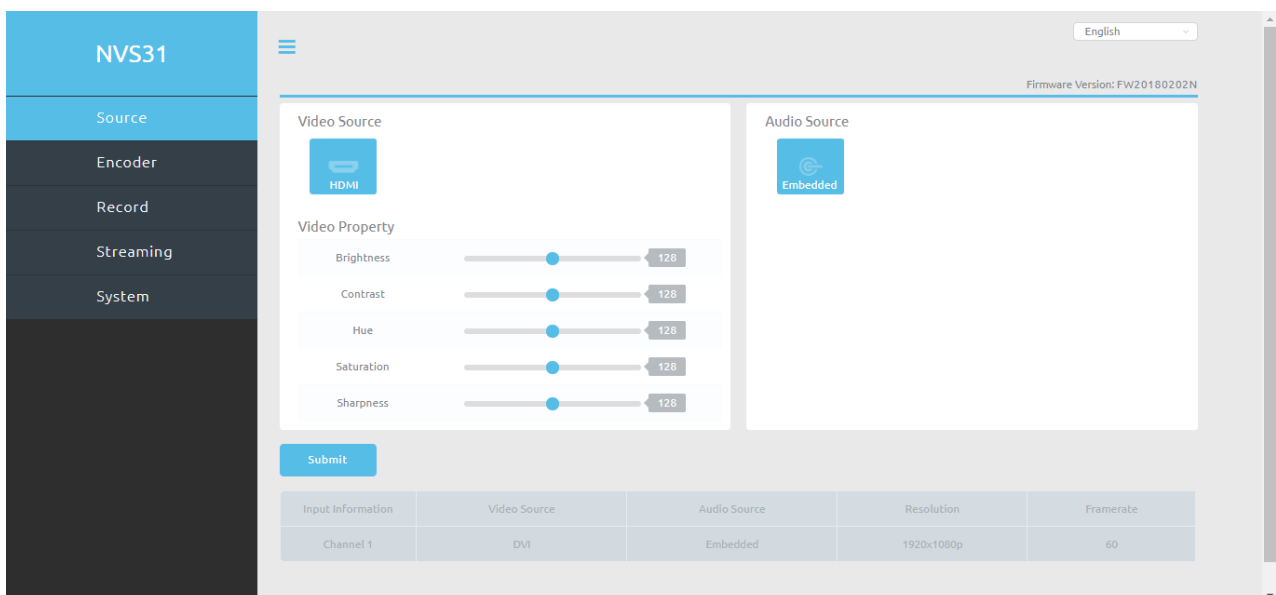

Source

The video source is fixed onto PGM View only. In the **Video Source** column, you will be allowed to adjust video properties such as **Brightness**, **Contrast**, **Hue**, **Saturation** and **Sharpness**. These parameters range from **0** to **255**.

The **Audio Source** column currently indicates that the audio is embedded into HDMI video and is **NOT** reserved for future development.

The **SOURCE** information (Channel No., Video Source, Audio Source, Resolution and Frame Rate) will be displayed in a table at the bottom of the page.

Firmware Version: FW20180202N

Video Source



HDMI

Video Property

Brightness	<input type="range"/>	128
Contrast	<input type="range"/>	128
Hue	<input type="range"/>	128
Saturation	<input type="range"/>	128
Sharpness	<input type="range"/>	128

Audio Source



Embedded

Input Information	Video Source	Audio Source	Resolution	Framerate
Channel 1	DVI	Embedded	1920x1080p	60

Encoder

The NVS-31 provides the user with two encoders so that you can stream and record videos with different encode settings. The Main Encoder and Sub Encoder can be applied to the recorder and the streaming server in four different combinations as shown in the table below:

Recorder	Streaming Server
Main Encoder	Main Encoder
Main Encoder	Sub Encoder
Sub Encoder	Main Encoder
Sub Encoder	Sub Encoder

Clicking the Encoder tab in the left column will open the Encoder Configuration page on the right.

Main Encoder		Sub Encoder	
Resolution	Same as Input	Resolution	Same as Input
Framerate	30.00	Framerate	Same as Input
Profile	High	Profile	Main
Video Bitrate (bps)	16 M	Video Bitrate (bps)	16 M
Audio Bitrate (bps)	128 K	Audio Bitrate (bps)	128 K
GOP	60	GOP	60
Cropping	X: 0 Y: 0	Cropping	X: 0 Y: 0
Cropping	W: 0 H: 0	Cropping	W: 0 H: 0

The encoder parameters are described below:

Resolution

The first step of encoder setup is to adjust the image size. The NVS-31 allows you to select a resolution from the list below.

- 1920 x 1080
- 1280 x 720
- 960 x 540
- 720 x 576
- 720 x 480
- 640 x 480
- 320 x 240
- 160 x 128

Frame Rate

Select the Frame Rate after the resolution is selected.

- Same as Input
- 60.00
- 50.00
- 30.00
- 25.00
- 20.00
- 15.00
- 10.00
- 5.00
- 1.00

Profile

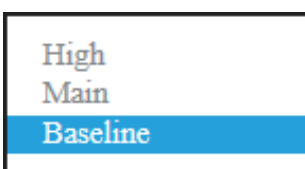

Profile sets the H.264 encoding profile for your stream. The available options are **Baseline**, **Main**, and **High**. Typically, **High** profile provides the best image quality and is suitable in most instances. However, depending on the decoder used when viewing the stream, such as with mobile devices, a Main or Baseline profile may be required.

be required.

Video Bitrate (bps)

The bitrate of the video specifies the amount of information stored in the video. The higher the bitrate is, the clearer the video is.

The bitrate ranges from 256K to 16M as shown in the table below.

- 16 M
- 12 M
- 8 M
- 6 M
- 4 M
- 3 M
- 2.5 M
- 2 M
- 1.5 M
- 1 M
- 512 K
- 256 K

For example, SD video may appear acceptable at 1000 Kbps (1M) but HD video is unacceptable at 1000 Kbps. Recommendations of the video bitrate settings are outlined as follows:

- When NVS-31 is in record-only mode, the recommended video bitrate is 16 Mbps.
- When NVS-31 is in stream-only mode, the recommended video bitrate is 10 Mbps.
- When NVS-31 streams and records simultaneously, sum of the stream and record video bitrates should not exceed 12Mbps.

When streaming, the NVS-31 converts video into data, which are sent across an IP network. High bitrates consume more bandwidth across the IP network. In a gigabit office LAN, high bitrate may not be a concern and Speed/Bandwidth is therefore not the limitation in a NVS-31 application environment.

Audio Bitrate (bps)

Select the bit rate at which you want to stream or record the audio.

- 384 K
- 256 K
- 128 K
- 64 K
- 32 K

GOP

GOP pattern with longer GOP length encodes video very efficiently. Shorter GOP lengths usually work better with video that has quick movements, but they do not compress the data rate as much. On the NVS-31, there are 16 GOP sizes available for the user, ranging from 1 to 180.

- 180
- 160
- 140
- 120
- 100
- 60
- 50
- 30

- 25
- 20
- 15
- 10
- 5
- 3
- 2
- 1

Cropping

The cropping feature allows the user to select a confined area of the camera video. X and Y parameters select the center of the video crop. After that, the user can then set W and H values to select the size of the crop.

Record

The **Record Settings** page of the Web User Interface allows you to set the record settings for the NVS-31 device.

The parameters on the **Record** page are described as follows:

Main Record Column

Encoder Source

Select the encoder for your recorder; there are MAIN and SUB encoders.

File Name

In the text bar, enter the file name of the recorded video.

File Size

Select the maximum record file size

Loop Recording

Loop recording allows the user record continuously to the disk. Select YES to enable loop recording and NO to disable.

Recording File

This text box displays the recording file name.

Storage Information Column

In this column, the user will be able to view the USB drive information such as the **Vendor Name, Product Type, Disk Capacity** and **Disk Format Type**.

Note: The SD Card will be formatted immediately as soon as the Format USB Disk button is clicked.

Storage Content

Disk contents are displayed here, **providing** an overview of different directories and files.

Storage Content

Name	Last Modified	Size	Type
Parent Directory/	-	-	Directory
RECORD_0001.mp4	2018-Mar-13 09:54:40	52.0M	application/octet-stream
RECORD_0002.mp4	2018-Mar-13 09:55:10	12.5M	application/octet-stream
sub_record_0001.mp4	2018-Mar-13 10:55:04	3.8G	application/octet-stream
sub_record_0002.mp4	2018-Mar-13 11:54:56	3.8G	application/octet-stream
sub_record_0003.mp4	2018-Mar-13 12:37:02	3.8G	application/octet-stream
sub_record_0004.mp4	2018-Mar-13 13:02:54	2.9G	application/octet-stream
sub_record_0005.mp4	2018-Mar-13 13:03:35	0.0K	application/octet-stream

lighttpd/1.4.34

Streaming

The NVS-31 provides RTSP and RTMP streaming protocols for use on Adobe Media Servers, Wowza Media Servers, software video players such as QuickTime and VLC, or any of the popular Content Delivery Networks (CDNs), such as YouTube Live and Ustream.

RTSP Mode

In RTSP mode, the NVS-31 acts as a streaming server to which clients can connect via a media server, software video player, or CDN that supports the RTSP streaming protocol. If you want to stream to more than a handful of clients, we recommend using a dedicated media server to send streams to clients.

To configure the RTSP stream server, select the **Encoder Source** first and then enter the respective port numbers. To start streaming, simply click the **“Start Stream”** button after the server is configured.

Main Streaming

Stream Type
RTSP

Encoder Source
Sub Encoder

RTSP Port
554

RTSP HTTP Port
8000

RTSP Account

RTSP Password

Start Stream Stop Stream

As soon as the stream is started successfully, you will be able to see the RTSP view link (**Play URL**) displayed as shown in the diagram below. To view the stream, open the **Play URL** in VLC Video Player.

Main Streaming

Stream Type
RTSP

Encoder Source
Sub Encoder

RTSP Port
554

RTSP HTTP Port
8000

RTSP Account

RTSP Password

Play URL
rtsp://192.168.1.151:554/live2

Play URL
rtsp://192.168.1.151:8000/live2

Start Stream Stop Stream

Open VLC Media Player and click “**Open Network Stream.**”

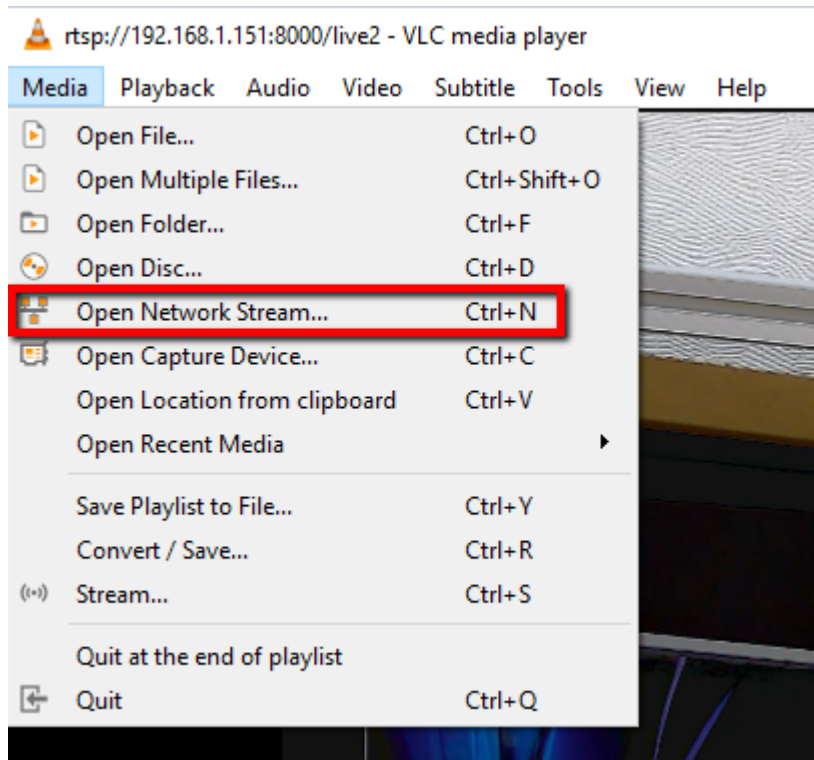

On the Open Media window, enter the Play URL “rtsp://192.168.1.151:8000/live” and then click the **Play** button to open the view window.

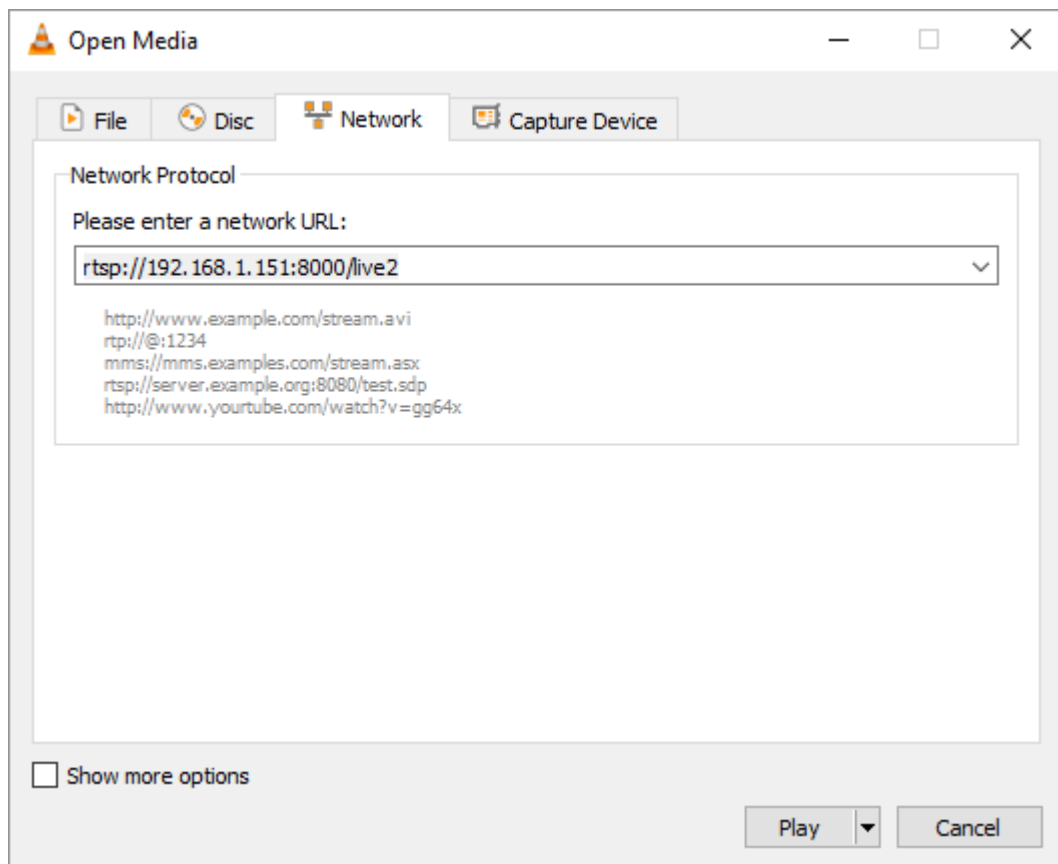

RTMP Mode

In RTMP mode, the NVS-31 can only send one data stream to one CDN or media server that supports the RTMP streaming protocol. On the streaming setup page, select the **Encoder Source** first and then enter the

respective RTMP stream information. To start streaming, simply click the “**Start Stream**” button after the **RTMP mode** is configured.

The screenshot shows a web interface titled "Main Streaming". It contains the following fields and controls:

- Stream Type:** A dropdown menu with "RTMP" selected.
- Encoder Source:** A dropdown menu with "Main Encoder" selected.
- RTMP URL 1:** A text input field containing "rtmp://a.rtmp.youtube.com/live2".
- StreamName 1:** A text input field containing "r40c-gj3r-yqf6-08kq".
- Account 1:** An empty text input field.
- Password 1:** An empty text input field.

At the bottom of the form, there are two buttons: "Start Stream" (light blue) and "Stop Stream" (dark blue).

TS Mode

In MPEG transport stream mode, the NVS-31 can send stream data directly to the viewer. On the streaming setup page, select the **Encoder Source** first and then enter the TS IP address and the TS port number. To start streaming, simply click the “**Start Stream**” button after the **TS mode** is configured.

The screenshot shows a web interface titled "Main Streaming". It contains the following fields and controls:

- Stream Type:** A dropdown menu with "TS" selected.
- Encoder Source:** A dropdown menu with "Main Encoder" selected.
- TS IP:** A text input field containing "239.100.100.100".
- TS Port:** A text input field containing "12345".

At the bottom of the form, there are two buttons: "Start Stream" (light blue) and "Stop Stream" (dark blue).

System

The NVS-31 also allows the user to configure the system's network settings, set account login credentials, update the device firmware, select the time, restore the factory defaults and reboot the system.

The screenshot displays the system configuration interface with the following sections:

- Network Setting:** DHCP is set to 'Enable'. Static IP is 192.168.1.60, Subnet Mask is 255.255.255.0, Default Gateway is 192.168.1.254, Primary DNS is 192.168.1.1, Secondary DNS is 8.8.8.8, and MAC ADDRESS is 00:07:36:03:C0:0A.
- Time Setting:** NTP is time.windows.com, Date is 2018-03-14, and Time is 14:04:22.
- Firmware Update:** File Path is empty. Two red warning messages are present: 'Please Stop Recording For Firmware Update!' and 'Please Stop Streaming For Firmware Update!'.
- Account Setup:** Original Account and Original Password fields are empty.
- System Related:** Buttons for 'Restore to Default' and 'System Reboot' are visible.

Network Setting

You are allowed to connect the NVS-31 to a network in DHCP or Static IP mode. Disable DHCP server if you want to connect to the NVS-31 on a fixed IP. An example of Static IP mode configuration is provided below:

The screenshot shows the Network Setting configuration form with the following values:

- DHCP: Disable
- Static IP: 192.168.1.60
- Subnet Mask: 255.255.255.0
- Default Gateway: 192.168.1.254
- Primary DNS: 192.168.1.1
- Secondary DNS: 8.8.8.8
- MAC ADDRESS: 00:07:36:03:C0:0A

- Static IP: 192.168.1.60
- Subnet Mask: 255.255.255.0
- Default Gateway: 192.168.1.254
- Primary DNS: 192.168.1.1
- Secondary DNS: 8.8.8.8

Note: If you do not remember the IP address assigned to the device, follow the steps below to reset the network settings:

- Turn off the machine.
- Press the **RECORD** and **STREAM** buttons simultaneously and switch ON the device.
- Wait for 5 seconds approximately and release the button push as soon as the two buttons light up.
- The default IP address is **192.168.1.60**.

Account Setup

Change the password in the Account Setup.

Account Setup

Original Account

Original Password

Submit

Firmware Update

From time to time Datavideo may release new firmware to either add new features or to fix reported bugs in the current NVS-31 firmware. To update the firmware, you must first click the Browse button to search for the firmware file on the disk.

Firmware Update

File Path

Browse Update

Please note that if the device is recording or streaming, you have to turn the features off in order to perform the firmware update.

File Path

Please Stop Recording for Firmware Update!

Please Stop Streaming for Firmware Update!

Once the firmware file is selected, you will see the prompt display as shown below indicating that the file is being uploaded.

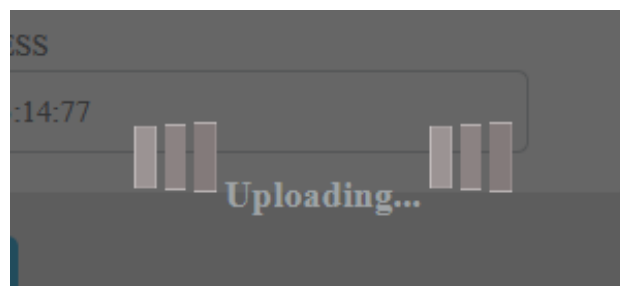

You will see the message shown below after the file upload is complete.

File uploading success, Please click update!

Once the file is uploaded successfully, click the **Update** button to start the update.

Firmware Update

File Path

Browse

Update

The device will reboot itself after the firmware is successfully updated.

Preparing for Rebooting!

48 Secs

Time Setting

Enter the device's time setting for recording purpose. Specify your time server in the **NTP** field.

Time Setting

NTP

Date

Time

Submit

System Related

Click the **Restore to Default** button to reset the NVS-31 to factory defaults. To reboot the NVS-31, simply click the **System Reboot** button.

System Related

Restore to Default

System Reboot

Chapter 6 Advanced Operations

6.1 Still Images

This section will show you how to import still images from the PC to the switcher and load the imported file to the switcher. You are also allowed to export still images from the switcher to the PC for file editing.

Export/Import Still Images to/from the PC

The switcher's Image Import/Export software (**SwitcherImageImEx_vx.x.x.msi**) allows the user to import still pictures from the PC to the designated Still number of the switcher and vice versa. **The software installation package can be downloaded from the product page.** Features of the Import/Export software are listed as follows:

- Supported file formats are BMP, JPG, PNG, and PIC.
- Minimum resolution is 1280 x 720.
- Independent exported still pictures in BMP format.

Please follow the steps below to set up the system before installing the software.

- First connect the HS-1300 to a Windows computer using an RJ-45 Ethernet cable.
- Since the HS-1300 has a default IP address of 192.168.100.101 so the computer should be given the IP settings that match the same IP range as the switcher.
- Turn on the Windows computer and manually set the IP to 192.168.100.X within the **Windows Network and Sharing Centre**.

After the connection is successfully established, the system setup is complete. Now install the **Switcher Image Import/Export utility** on the computer.

Installation

1. Download SwitcherImageImEx_vx.x.x.msi from the product page and save it on the local disk.
2. Click the installation file icon to start the Setup Wizard.
3. Click "**Next**"

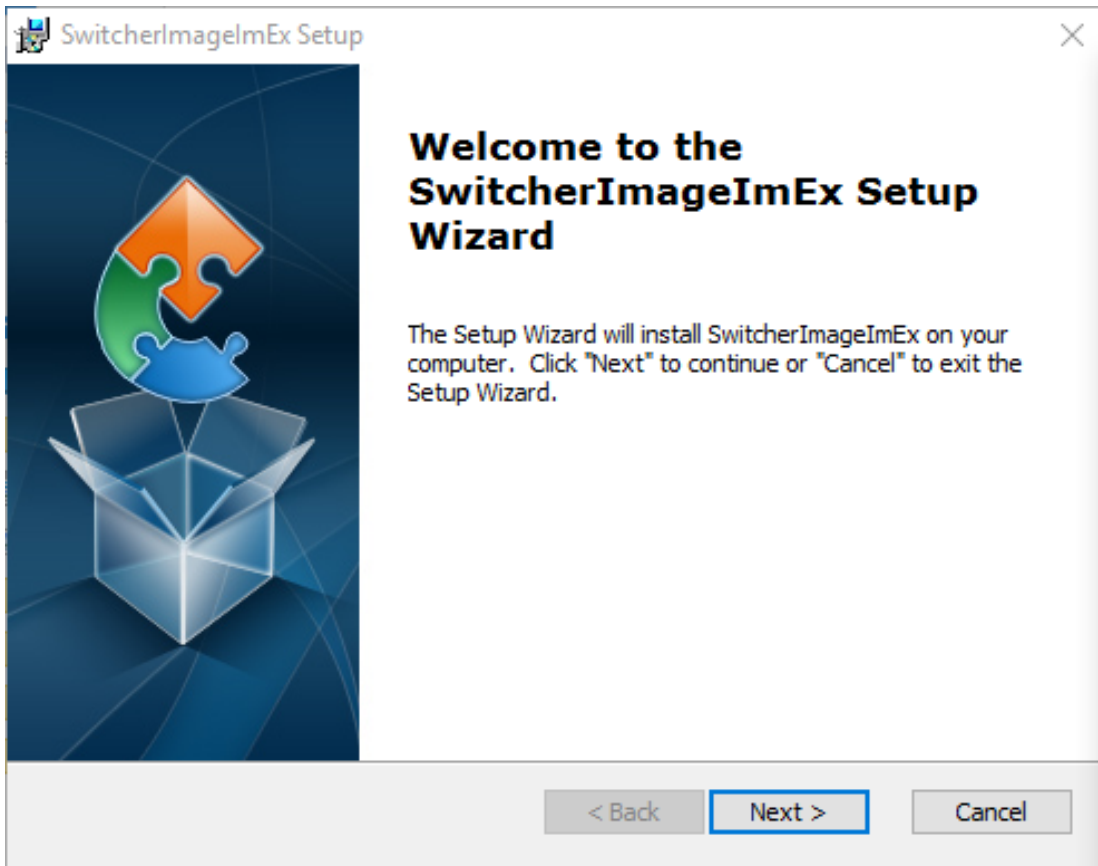

4. Click "Install"

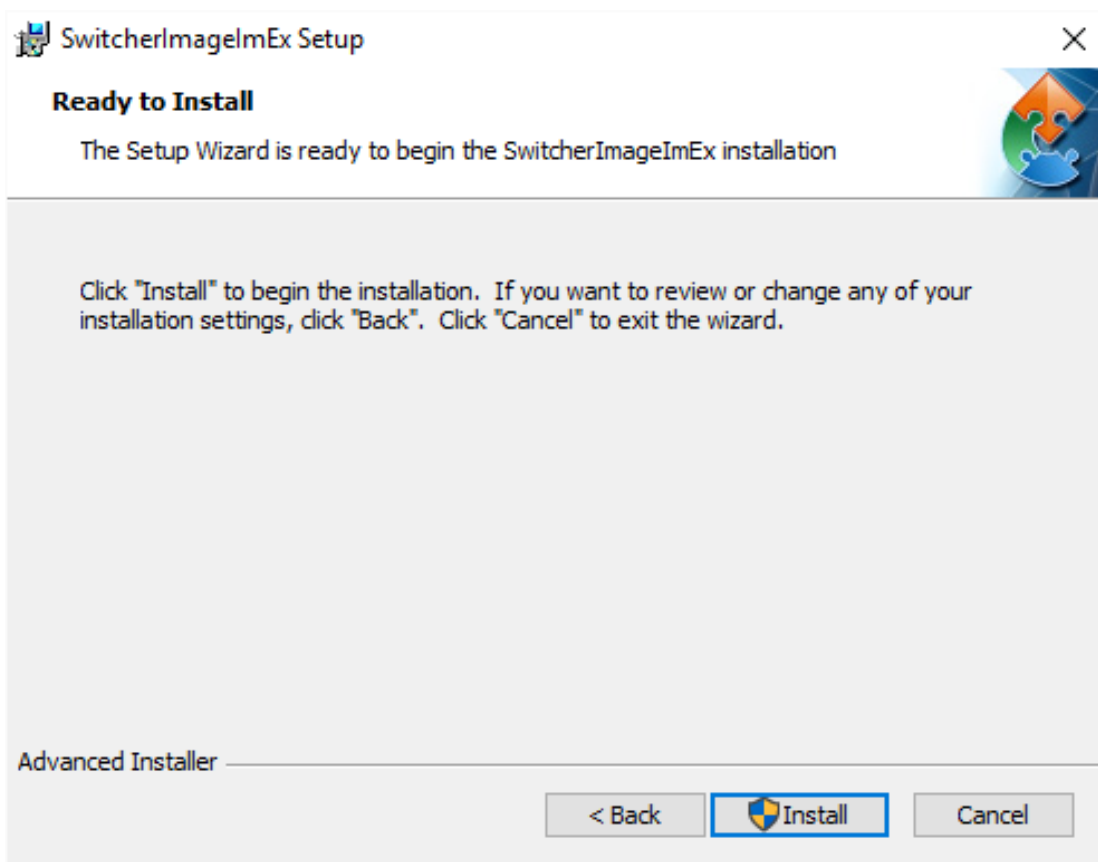

5. When you see the safety warning requesting for permission to allow an unknown publisher to make changes to the PC, please click "Yes" to continue.

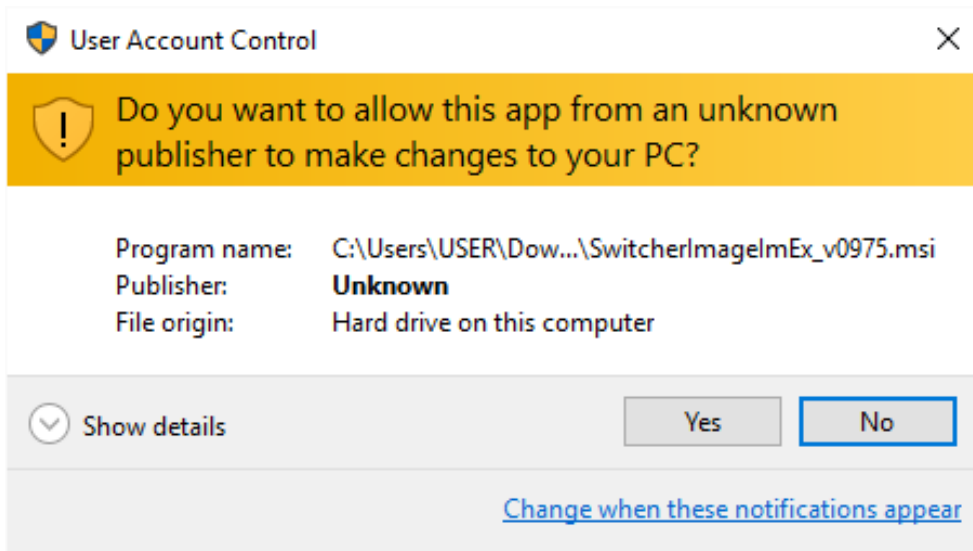

6. Wait for the installation to finish.

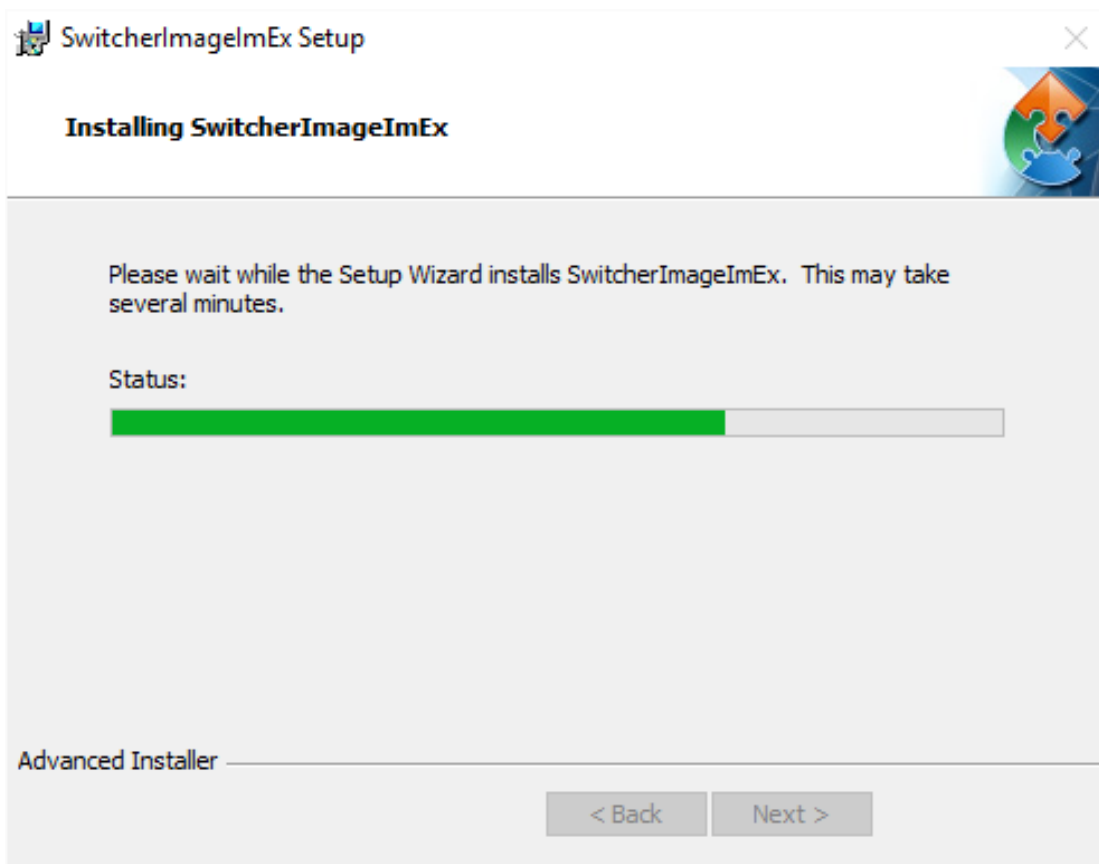

7. After the setup is complete, you will see the following window; click "Finish" to launch SwitcherImageImEx immediately.

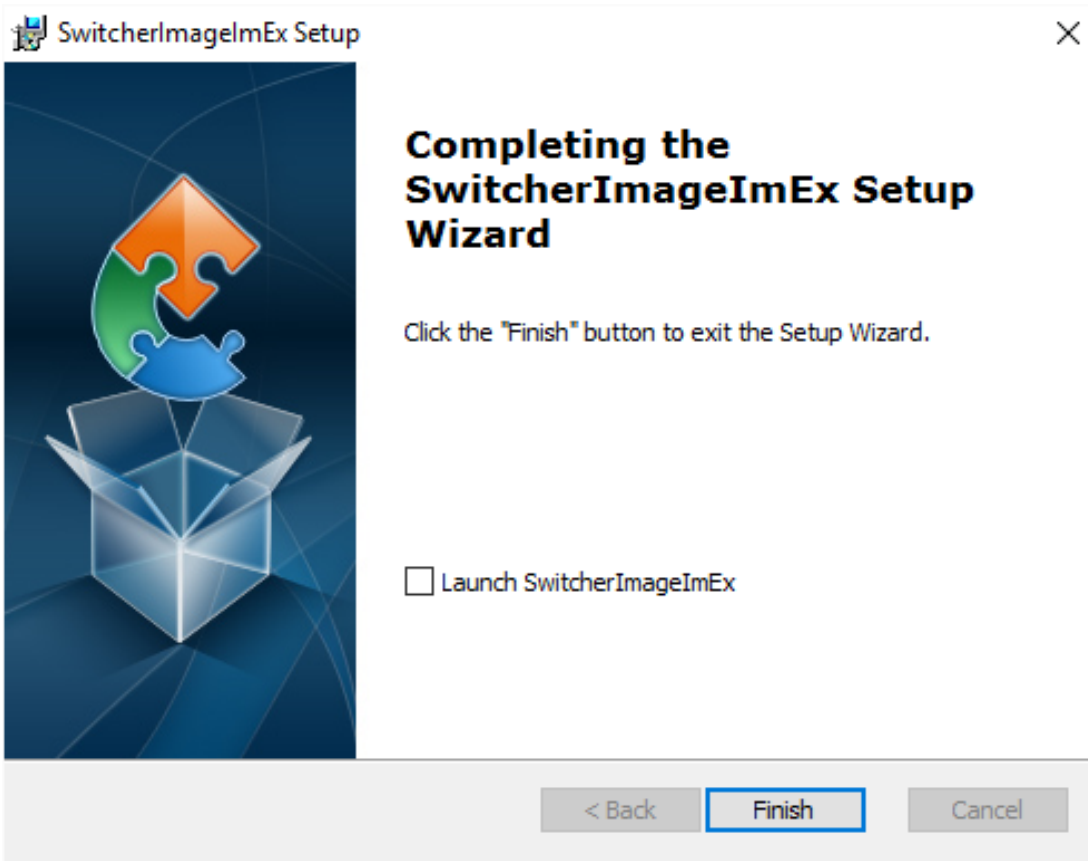

8. After the setup is finished, a shortcut will be created in Start Menu > Programs > datavideo > tools > SwitcherImageImEx

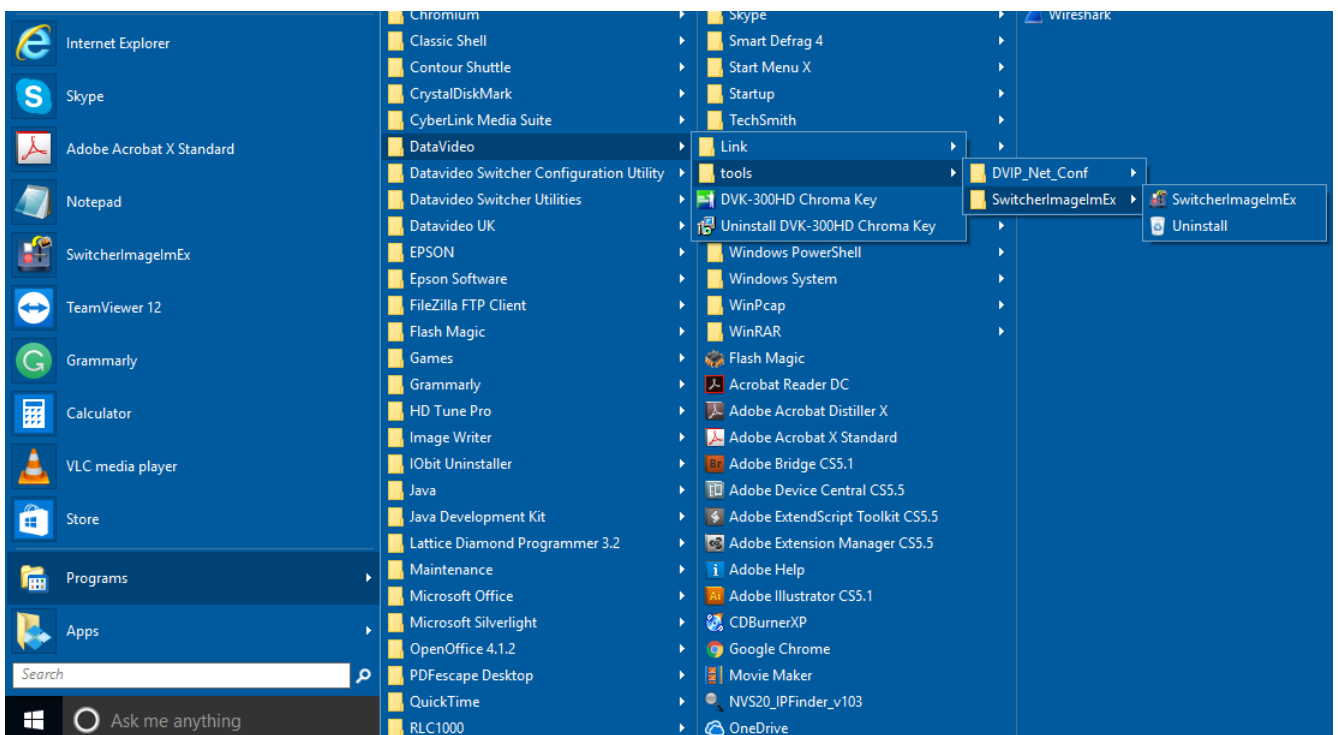

9. Click SwitcherImageImEx to open the program.

How to use

1. When the program is executed for the first time, it will automatically scan the network and if multiple network interface cards are found, please select the card that is on the same network as the device.

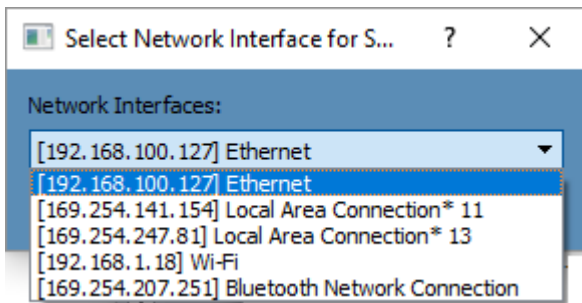

2. If the available device is scanned and found, the connection will be automatically established. After the connection is successfully established, the **Connect Status** will show “**Connected**” (will display **Not Connected** if disconnected).

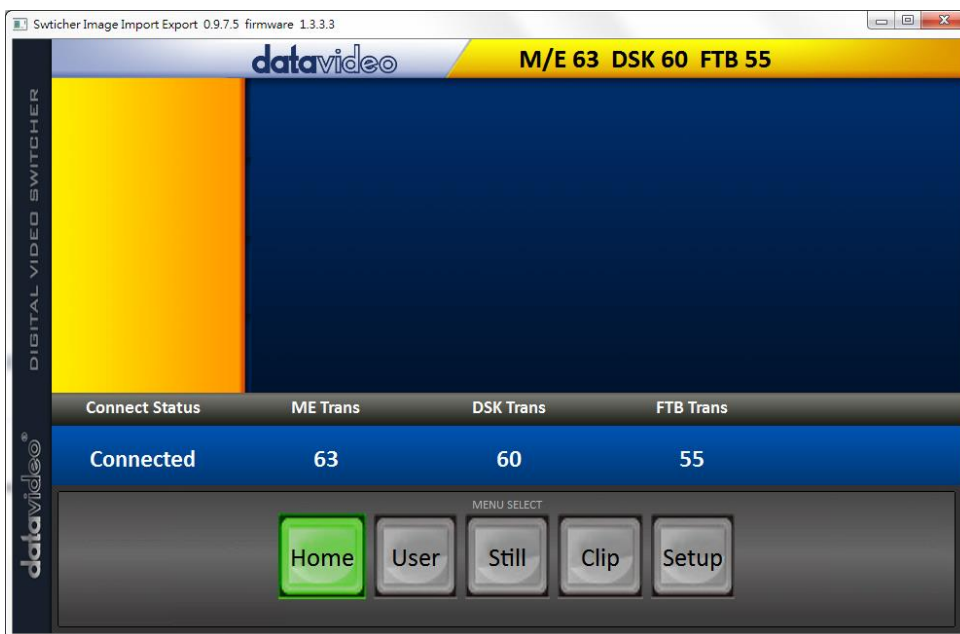

3. After clicking the **Setup** button, the network information will be displayed in the blue area (identical to the SE-1200 MU user control interface).



4. After clicking **Import-Export**, you will be able to see four options which are **Import Still**, **Import User**, **Import Clip** and **Export**.
5. When in Import Still, click a Still number first and enter a location for storing the still. Then click Import Still again, the interface for selecting picture files will appear. If the selected picture is not 1920x1080 or 1280x720, the following interface will be displayed to allow you to crop or enlarge the picture.

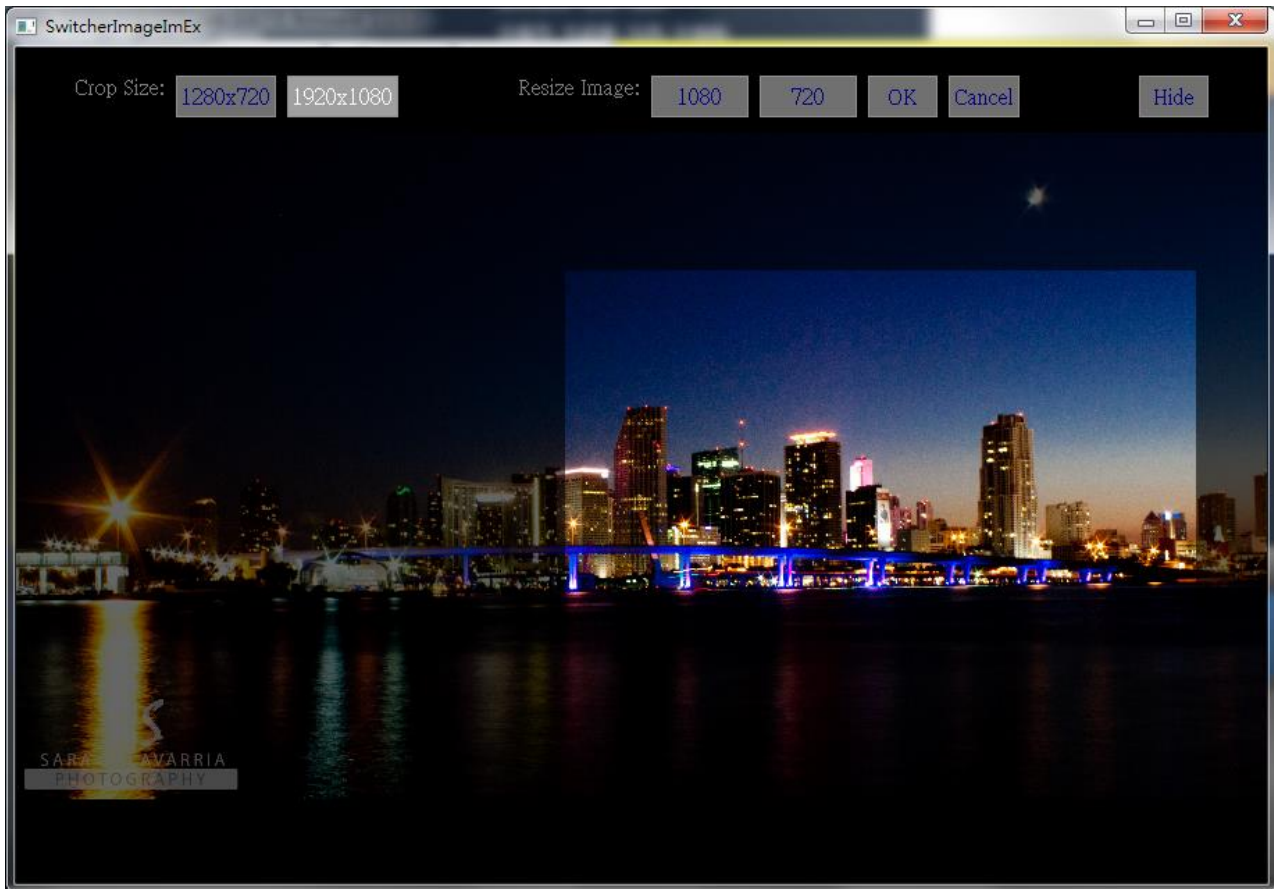

Crop Size: Select the right crop

Resize Image: You will be allowed to select two sizes, large (1080) or small (720), and zoom the picture to 1920 x 1080 or 1280 x 720.

OK: Confirm the setting and apply in the switcher.

Cancel: Cancel the selection

Hide: Hide the interface

6. After the right crop is selected or the resolution is correctly configured, the new settings will be automatically applied to the switcher. To confirm, click the **Still** button on the **MENU SELECT** pane to view the thumbnails.

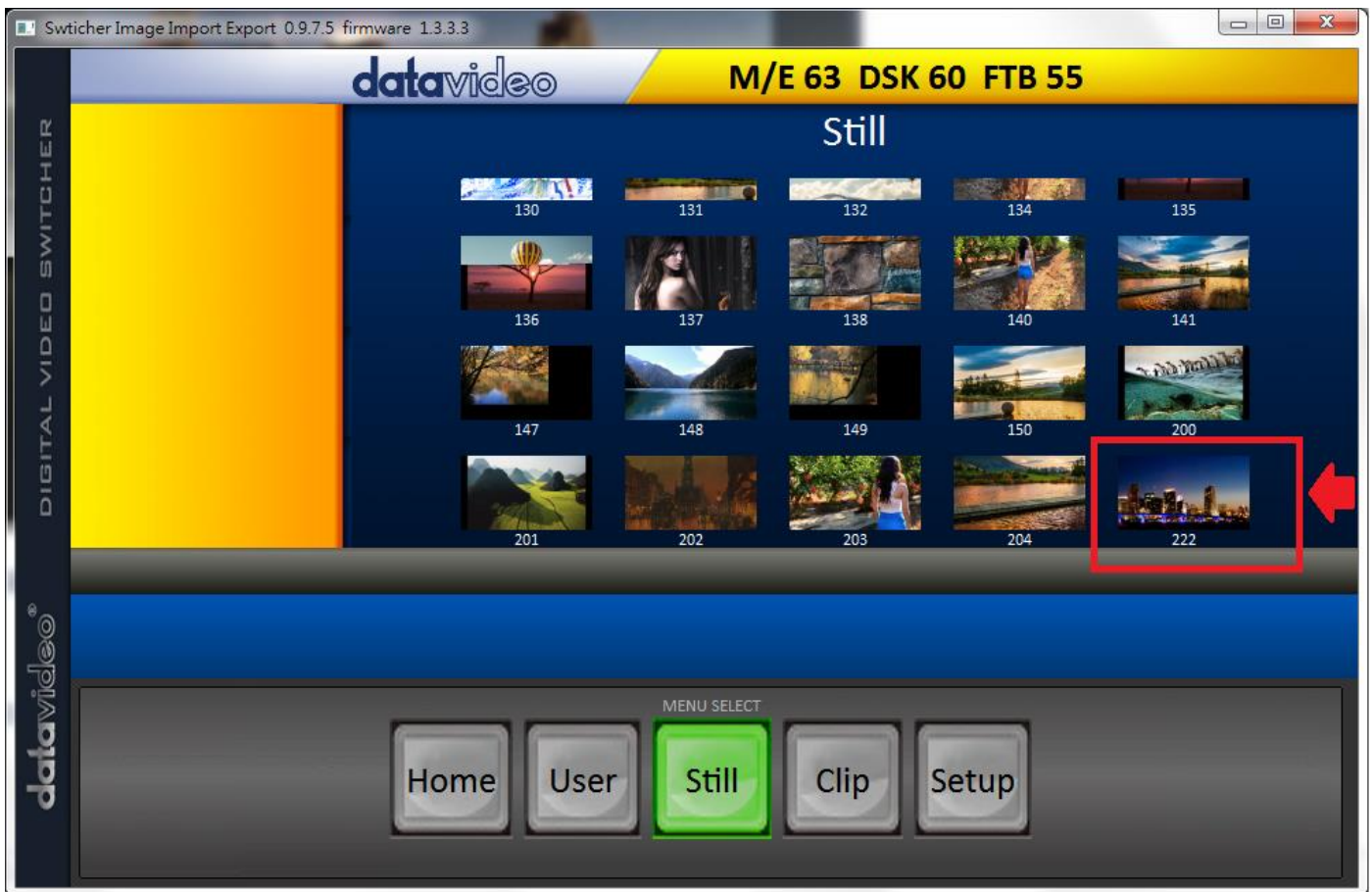

In addition to still picture import and export, the user is also allowed to import and export user memory slots to and from the PC. The **Import User** has the identical steps; select .mem file to import. The **Import Clip** allows the user to import the clip sequential files from the PC. The sequential files are numbered using the last five characters. Select one file and the system will automatically grab the file and the rest after that. The supported clip file formats are **BMP, JPG, PNG and PIC** and the optimal resolution is 1920 x 1080.

The software supports multiple languages which are English, Traditional Chinese and Simplified Chinese.

Note: The latest software version can be downloaded from the product page. To update the software, it is recommended to remove the existing program first. Click **“Start Menu > Programs > datavideo > tools > Uninstall”** to remove the program. If the program is not removed, the user will be prompted that the PC already contains the same program during the reinstallation process. Click **“Remove”** to remove **SwitcherImageImEx** from your computer.

Loading still images

The HS-1300 allows the user to load still images saved on the machine to the Multiview screen. Please follow the steps outlined below to load the still picture.

1. Press the **MENU** button to open the OSD menu on the Multiview display.
2. Open the **Stills** menu option as shown below.

Stills	Load Still	Load	Still Num 10	Still 1
		Thumbnail Picture - 1	Thumbnail Picture	Thumbnail Picture + 1
	Save Still	Save	Still 1	Still Num 10

	Grab Still	Grab	Still 1	
	Freeze	1 Live	2 Live	3 Live
		4 Live		

- In the **Load Still** sub-option, first select the still picture that you would like to load (**Still Num**). The still picture preview is shown in the row right below the **Load Still** row.
- Select **Load** to load the still picture to one of the following destinations:
 - Still 1
 - Still 2
 - Input 4
 - Input 3
 - Input 2
 - Input 1

6.2 Stinger Transition Effect

The Stinger Transition Effect is basically an animated effect added during transition of two video sources. The animated effect is generated by a clip file which consists of a series of sequential files in **bmp/jpg/png/pic** formats. In this section, you will be shown how you can load the existing clip on the switcher, and import the clip to the switcher from the PC.

Loading the existing Clip for Stinger Transition Effect

The HS-1300 allows you to generate the stinger transition effect. To do this, the user should first load the clip saved on the machine to the **CH6 window** of the Multiview screen first. Please follow the steps outlined below to load the clip.

- Press the **MENU** button to open the OSD menu on the Multiview display.
- Move to the **User Mem**s menu option as shown below.

User Mem s	Load Mem	Memory 13	Load	
	Save Mem	Memory 13	Save	
	Load Clip	Load	Clip 0	
		Thumbnail Clip - 1	Thumbnail Clip	Thumbnail Clip + 1
		Clear Clip	Delete Clip	

- In the **Load Clip** sub-option, first select the clip that you would like to load. The **Clip Preview** is shown in the row right below the Load Clip row.
- Select **Load** to load the clip to the **CH6 window**. The load progress prompt "**Loading Clip XX/XX ...**" will appear. Once loaded, the previously displayed video or image will be replaced.

Note: The load process can take up to tens of seconds.

- To enable the Clip or Stinger transition mode, please press the **MIX** and **WIPE** buttons at the same time.

Restoring CH6 window for Live or Still mode

If the Clip transition is no longer needed, you may free up the CH6 window for other modes of use such as Still and Live. Follow the steps outlined below to re-configure the CH6 source.

1. Press the **MENU** button to open the OSD menu on the Multiview display.
2. Open the **User Mems** sub menu as shown below.

User Mems	Load Mem	Memory 13	Load	
	Save Mem	Memory 13	Save	
	Load Clip	Load	Clip 0	
		Thumbnail Clip - 1	Thumbnail Clip	Thumbnail Clip + 1
		Clear Clip	Delete Clip	

3. Select **Delete Clip** to clear the clip buffer (CH6).
4. Exit the **User Mems** sub menu.
5. Enter the **Inputs** sub menu as shown below.

Inputs	Input 1	Black 0%	White 100%	Chrom 1.0
	Input 2	Black 0%	White 100%	Chrom 1.0
	Input 3	Black 0%	White 100%	Chrom 1.0
	Input 4	Black 0%	White 100%	Chrom 1.0
	Freeze	1 Still	2 Live	3 Still
		4 Still	5 Still	6 Live
	Crosspoint	1 Input 1	2 Input 2	3 Input 3
		4 Input 4	5 Input 5	6 Input 6

6. Move to the Freeze option and set CH6 to Live or Still.

Importing the Clip for Stinger Transition Effect from the PC

On the HS-1300, you will be able to add a clip between sources. Besides using the existing clips on the machine, you are also allowed to import your own clip (a series of **bmp/png/jpg/pic** files) to the HS-1300 from the PC using the **Switcher Image Import/Export utility**, which can be downloaded from the HS-1300 product page.

- First connect the HS-1300 to a Windows computer using an RJ-45 Ethernet cable.
- Since the HS-1300 has a default IP address of 192.168.100.101 so the computer should be given the IP settings that match the same IP range as the switcher.
- Turn on the Windows computer and manually set the IP to 192.168.100.X within the **Windows Network and Sharing Centre**.
- Now install the **Switcher Image Import/Export utility** on the computer.
- After the utility is installed, click and open the user interface as shown below.

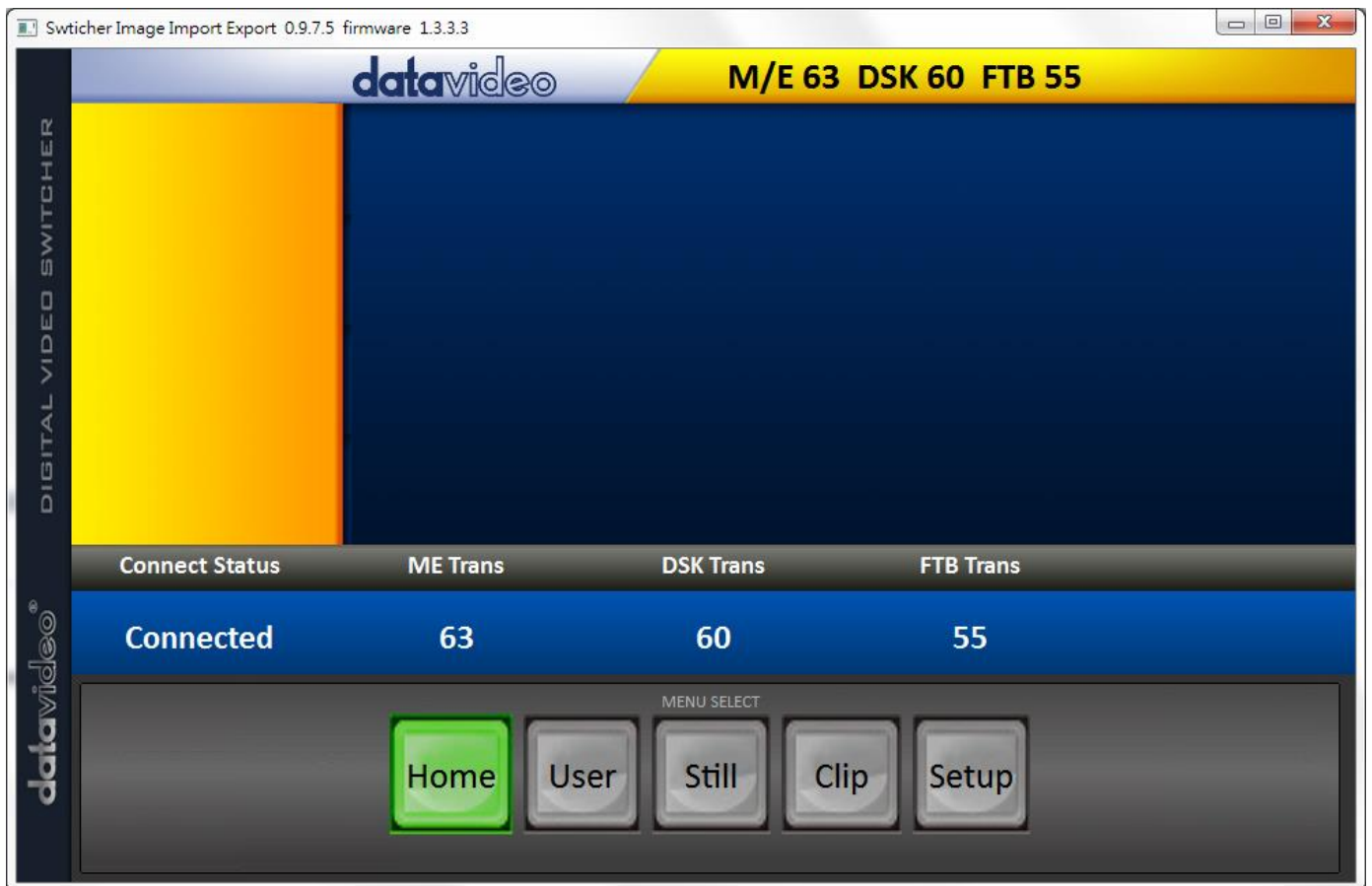

Click **Setup** on the **MENU SELECT** pane and if the connection between the HS-1300 and the PC has been successfully established, you will be able to see the network information of your switcher. Select **Import-Export** from the yellow menu options.



The clip number allows you to select a location where you can save the clip. To import a clip from the computer into the HS-1300, select **Import Clip**.

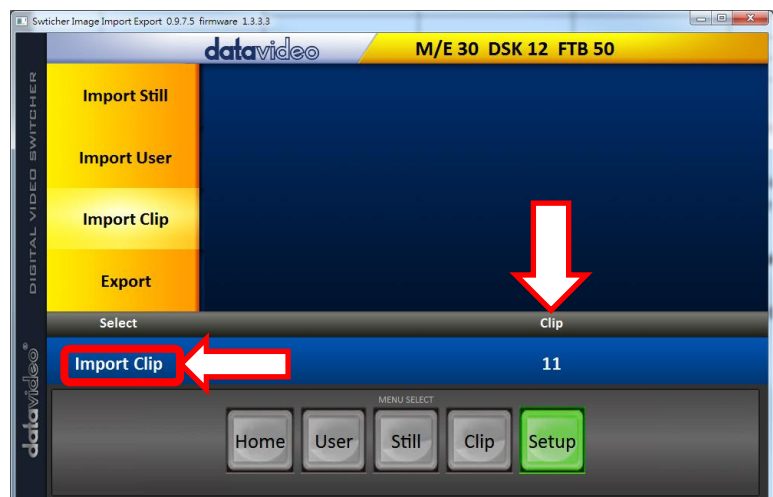

Note: The **Switcher Image Import/Export utility** does the conversion from bmp/png/jpg to the .pic file format. All you need is to give the utility a starting file location and it will give the utility an idea where to start linking all images up into a sequential animation file.

Importing Clips

Select **“Import Clip”** will open a file browser window. Browse to the directory where your clip files are saved and then select the file at the zeroth location, in our example on the right, the file name is ***frame-000.png***.

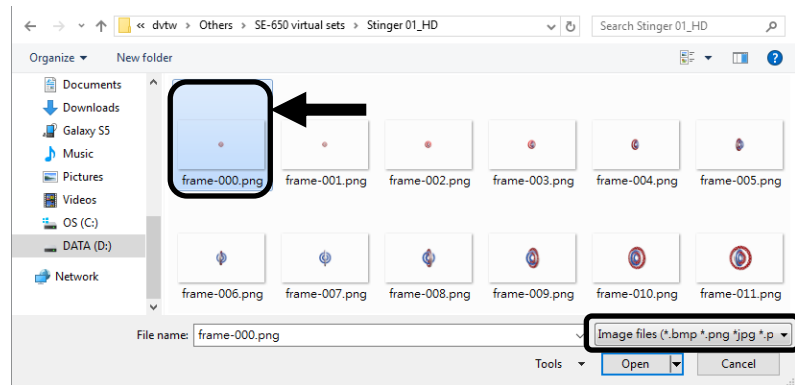

Click **Open** to start the clip import. If your files are not the .pic format, they will be automatically converted to .pic format by the **Switcher Image Import/Export utility** first.

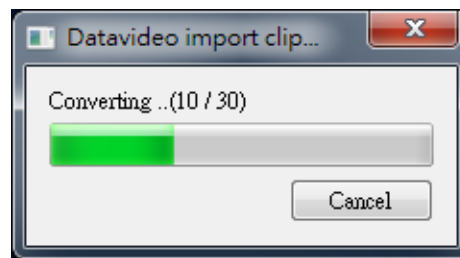

After the file conversion, the clip import will then start. After the import is complete, the progress dialog will be automatically closed.

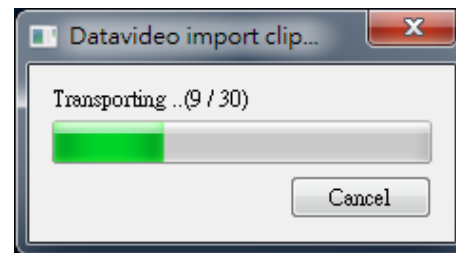

Note: Clip Conversion and Clip Import have progress dialogs that show progress & number of frames done. These dialogs also have a cancel button which allows the user to cancel the import at any stage. If the import is cancelled, then the partially imported data will be deleted.

How to Create the PNG Sequence for Stinger Transition Effect

Adobe After Effects is a motion graphics application that can be used for creating the clip file for stinger transition effect. After the clip file is created, there are two ways to convert the file to the PNG sequence format readable by the HS-1300 switcher in Adobe After Effects. In this section, we will show you how you can create the PNG sequence for the Stinger transition effect.

Adobe After Effects

1. Click **File** → **Export** → **Add to Render Queue** (or alternatively, you can also click **Composition** → **Add to Render Queue**).



2. The Render Queue will be displayed in the bottom pane.

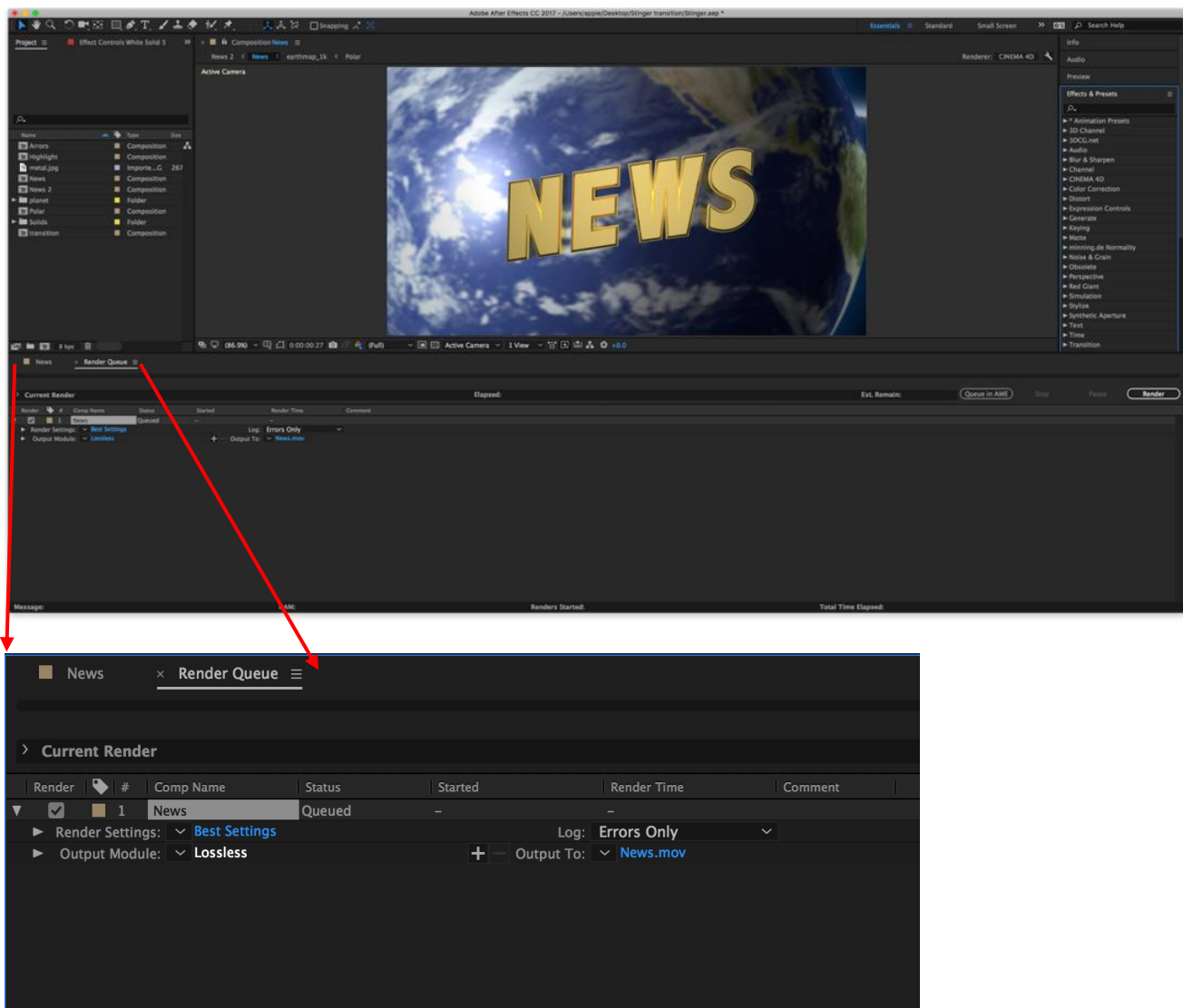

3. Click **Output Module** and on the **Main Options** window, click the **Format** dropdown list and select **PNG Sequence**.

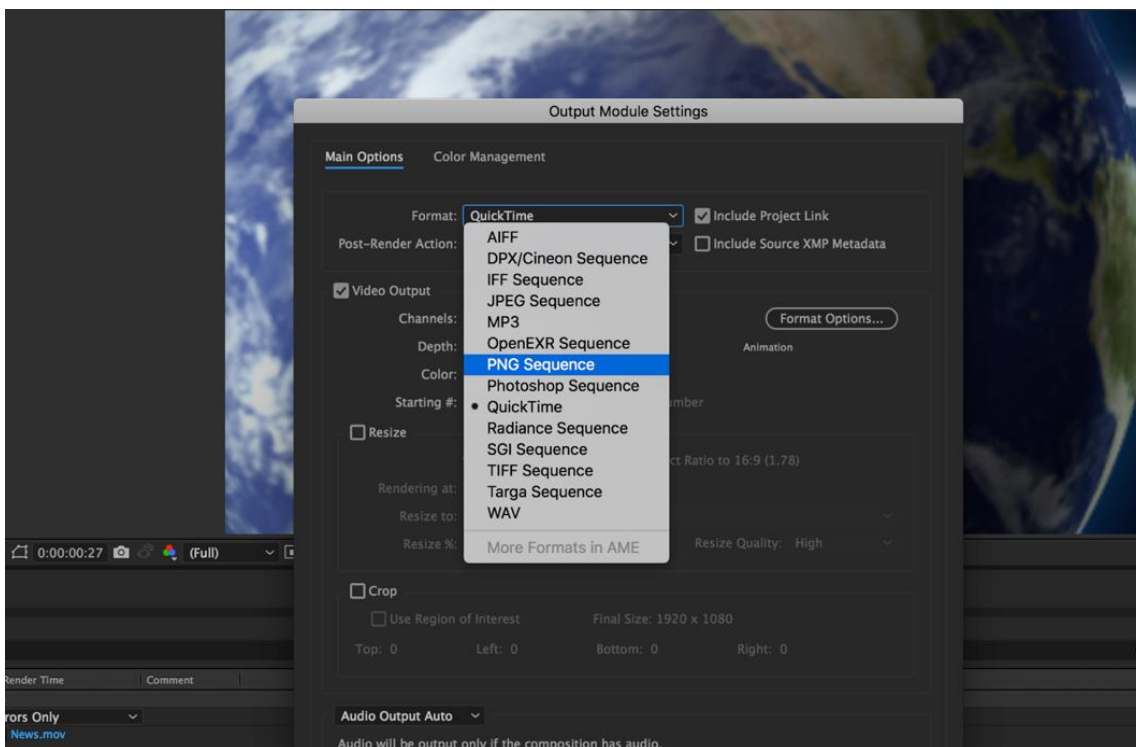

4. Click the **Channels** dropdown list and select the “**RGB + Alpha**” option.

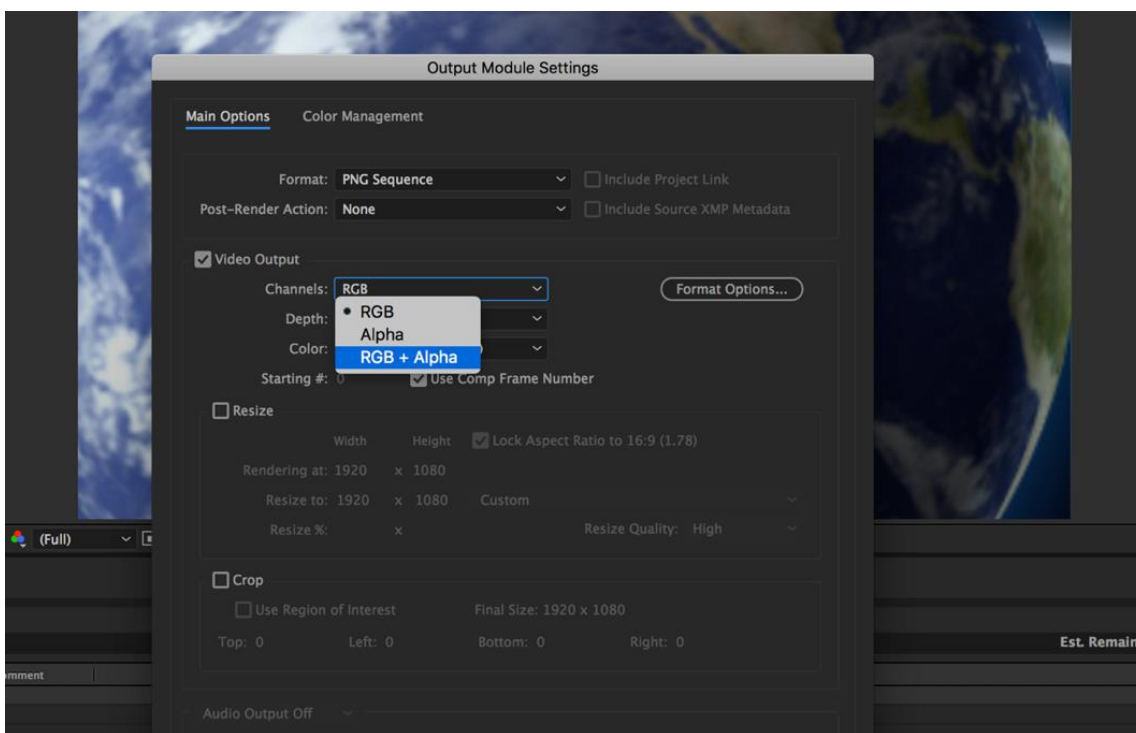

5. Click “**Output To**” and then change the location where your files are rendered. Click **Render** after that.

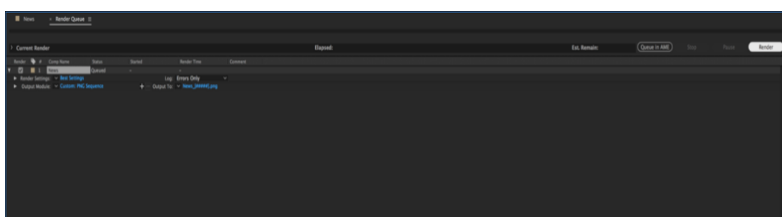

The next section outlines the file conversion procedure using the **Media Encoder CC**.

Media Encoder CC

1. Click **Composition** → **Add to Media Encoder Queue** (or alternatively, you can also click **File** → **Export** → **Add to Media Encoder Queue**).



2. Click blue fonts in **Format/Preset** fields to open the “**Export Settings**” window.

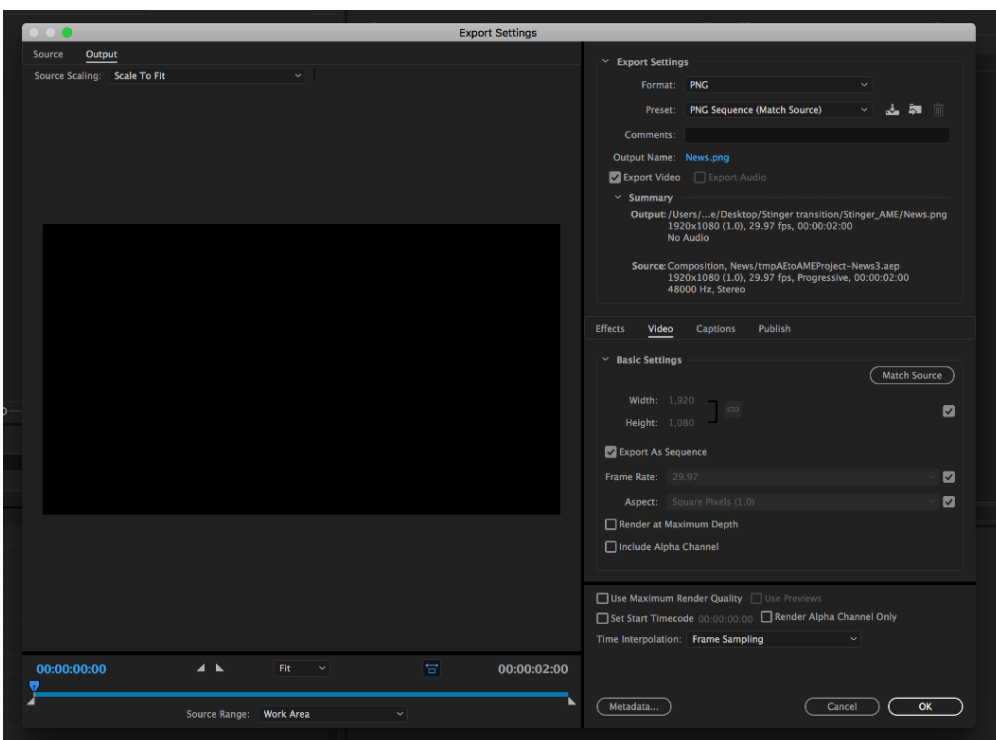
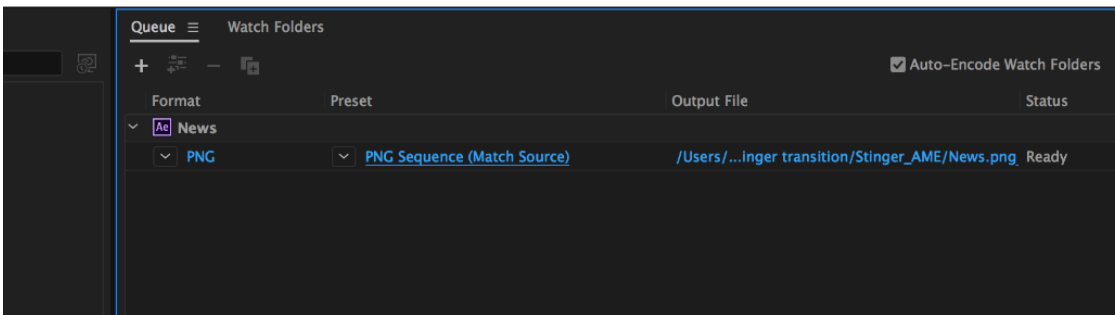

3. Click the **Format** dropdown list and then select **PNG**.

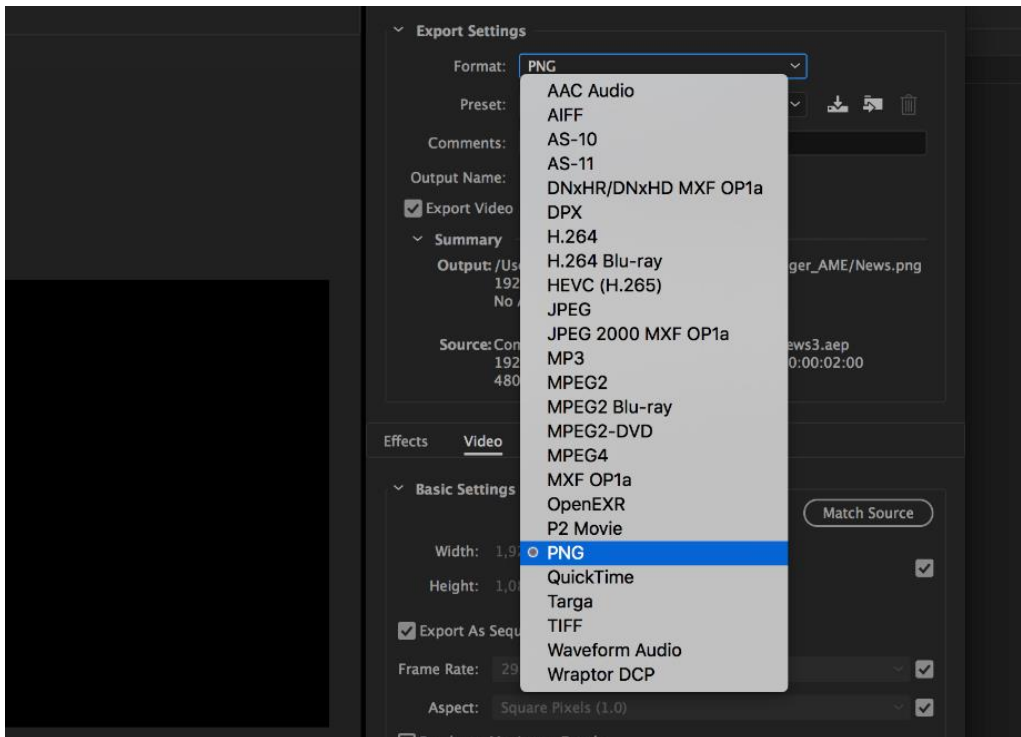

4. Click the **Preset** dropdown list and select **“PNG Sequence with Alpha.”**

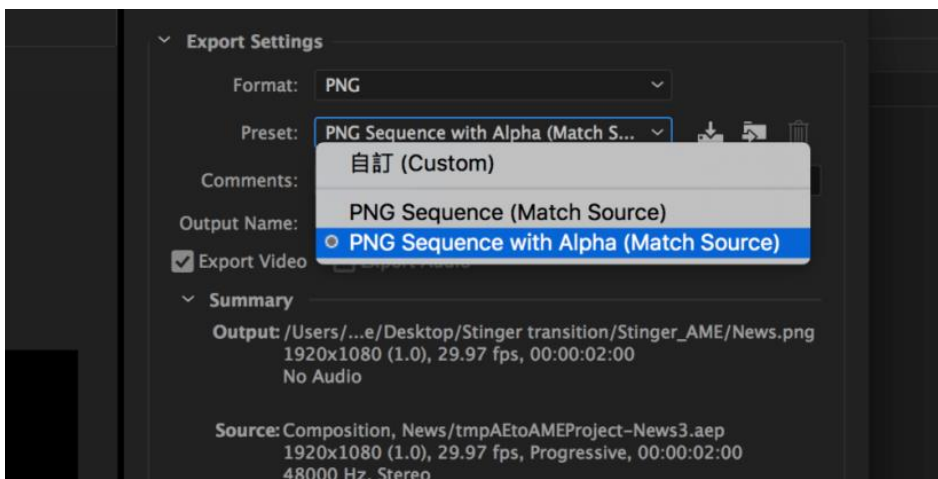

5. Make sure **“Export As Sequence”** and **“Include Alpha Channel”** are checked and then click **OK**.

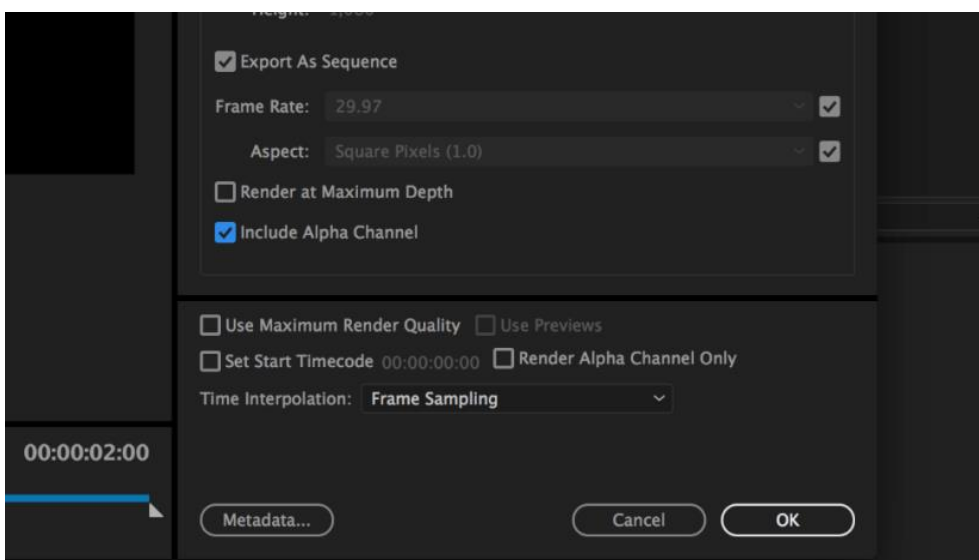

6. Select “**Output File**” to choose the render files destination. Click the green button to render.

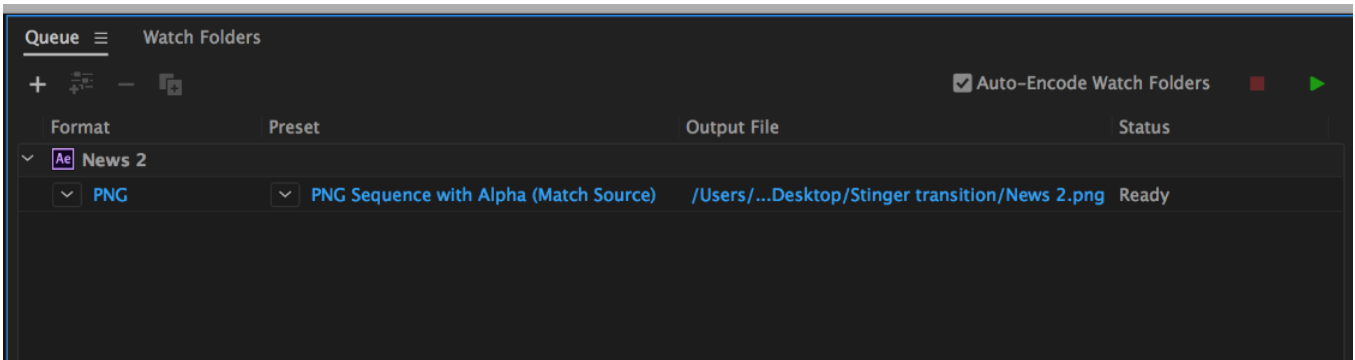

7. Once completed, the status will display “**Done.**”

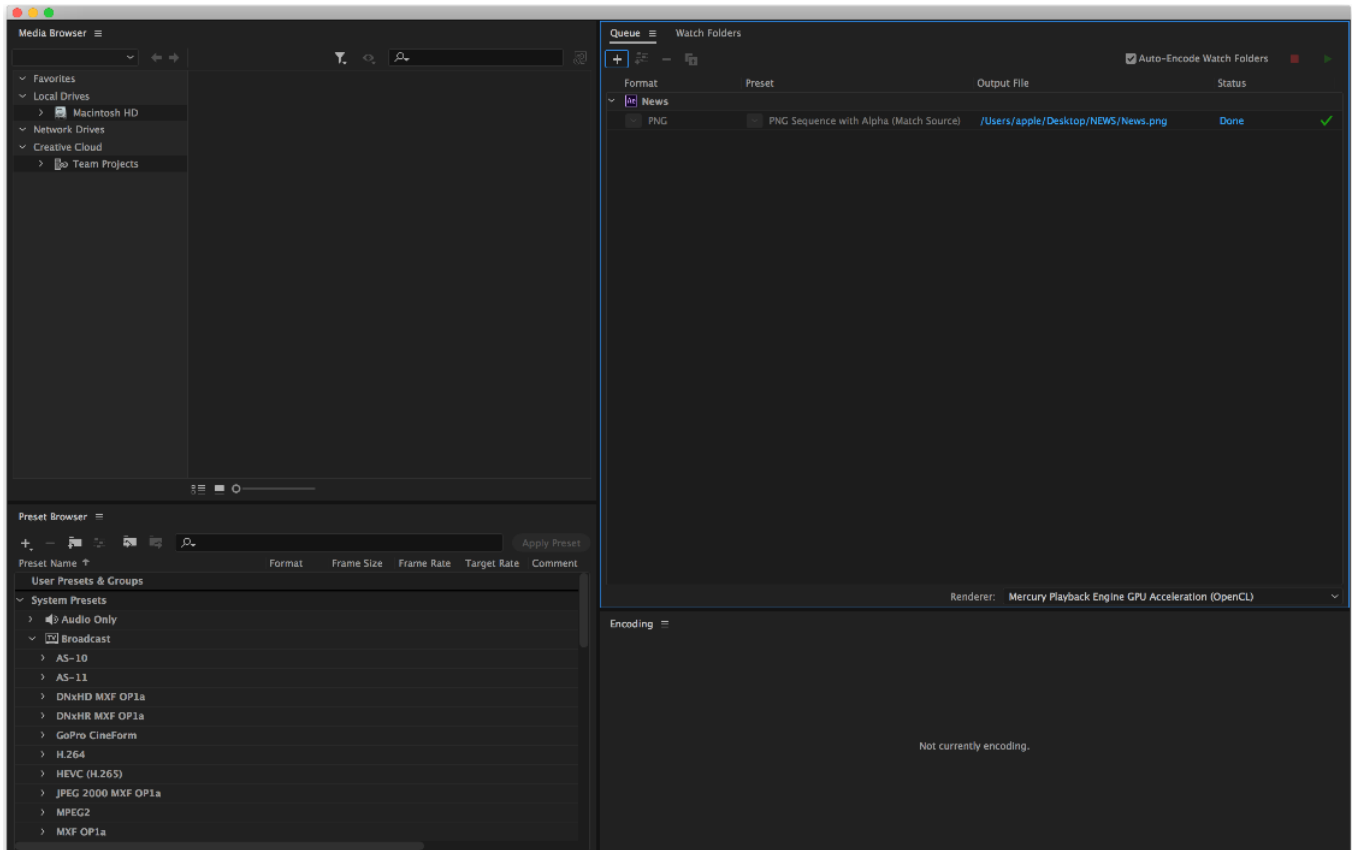

After the sequential files are created and ready, see section 5.4.2 to import the Clip file to the switcher.

Important things to note while creating Stinger Transition Effects

When using Datavideo’s HS-1300 Multi-Channel Switcher to design and create the Stinger Transition Effects, in addition to being creative, there are a few things that you need to take into account of.

1. Length limit of the stinger transition animation

The length of a good stinger transition animation should be approximately 0.5 to 2 seconds.

2. The HS-1300 allows a maximum of 200 image files in an animation sequence

The number of image files will determine the length of stinger transition time.

3. While designing the animation, it is best to have an image that fills up the entire frame to create a satisfactory visual effect (please see the images below).

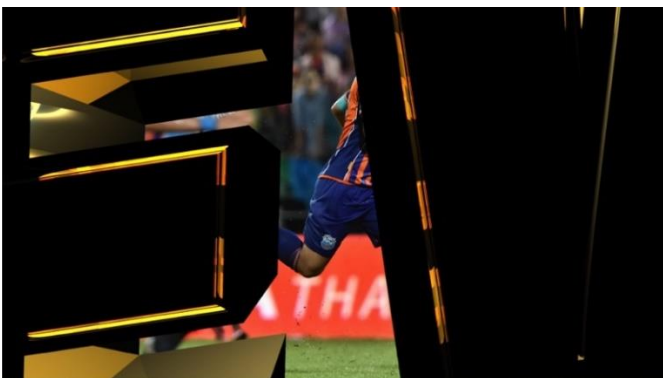

6.3 Chromakeyer

Performing the configuration steps below will allow you to preview the keyer effect on the Multiview by simply pressing **KEYER PGM** or **KEYER PVW** buttons.

1. Set up studio equipment including lights and the backdrop (Green/Blue).
2. Press the **"MENU"** button to open the Keyer Setting Menu.

Keyer	Keyer	Chroma	Self	Priority	Top
	Keyer Ctrl	Lift 0%	Gain 1.0	Opac	100%
	Key Source	Input 1	Fill Black		
	CK Setup	CK Auto	Hue 140	Luma	101%
		K 160	K Fgnd 10%	K Bgnd	90%
		Range			
		Hi-Light 0%	Lo-Light 0%	Bg-Supp	OFF
	Mask	Left 0%	Right 0%		
		Top 0%	Bot 0%		

3. Select “**Chroma**” and “**Split**” under the “**Keyer**” sub-option.
4. Select the camera signal to be chromakeyed under the “**Key Source**” sub-option.
5. Adjust the left, right, top and bottom values of the “**Mask**” sub-option to set the chroma key range based on the green or blue backdrop size.
6. CK Setup
 - Key Range defines a color range close to the color (blue/green) of the studio backdrop.
 - Key Foreground adjusts the opaqueness and transparency.
 - Key Background adjusts the chromakey performance to achieve perfect chromakeying.
 - Hi-Light and Lo-Light adjust luma value of the chroma key.
 - Bg-Supp removes foreground and background luma (brightness) from the final image.
7. Chroma Key setting is complete.

Remarks: The HS-1300 is equipped with auto chromakeying function so if after following the above steps, a clean chromakeying effect cannot be achieved, you may first use the CK Auto function under the CK Setup sub-option and then fine-tune other parameters to achieve perfect chromakeying.

6.4 Dual Chromakey

Dual-Chromakey is a function designed to allow you to apply chromakey effect to two camera images at the same time and overlay the results on Preview and Program displays.

Follow the steps below to set up the environment for dual chromakey.

1. Set up studio equipment including lights and the backdrop (Green).
2. Connect two cameras to switcher’s input 1 and 2. Note that the studio background must be green and the foreground can be a talent or an object. Connect background images to switcher’s input 3 and 4.
3. Press the “**MENU**” button to open the **Keyer** page as shown below:

Keyer	Keyer	Key 1			
	Keyer Ctrl	Chroma	P-in-P	Priority	Bot
		Lift 0%	Gain 1.0	Opac	100%
	Key Source	Input 1	Fill Input 3		
	Mask	Left 0%	Right 0%		
		Top 0%	Bot 0%		

4. Select “**Key 1**” under the “**Keyer**” sub-option.
5. Select the camera image to be chromakeyed under the “**Key Source**” sub-option. In this example, the source is “**Input 1,**” which is **Channel 1**.
6. Adjust the left, right, top and bottom values of the “**Mask**” sub-option to set the chroma key range, which is the green backdrop size.
7. Open the **Chroma** page as shown below:

Chroma		Keyer		Key 1					
		Key Source		Input 5					
		CK Setup		CK Auto		Hue	120	Luma	100%
				KRange	170	K Fgnd	15%	K Bgnd	67%
				Hi-Light	0%	Lo-Light	0%	Bg-Supp	On
		Mask		Left	0%	Right	0%		
				Top	0%	Bot	0%		

8. Adjust the following parameters under “**CK Setup.**”
 - Key Range defines a color range close to the color (green) of the studio backdrop.
 - Key Foreground adjusts the opaqueness and transparency.
 - Key Background adjusts the chromakey performance to achieve perfect chromakeying.
 - Hi-Light and Lo-Light adjust luma value of the chroma key.
 - Bg-Supp removes foreground and background luma (brightness) from the final image.
9. Chroma Key setting is done.
10. Repeat steps 1 – 9 to configure **Key 2**, which is the image captured by camera 2.
11. After dual chromakey is configured, enable Channel 3 on the Program BUS and Channel 4 on the Preset BUS.

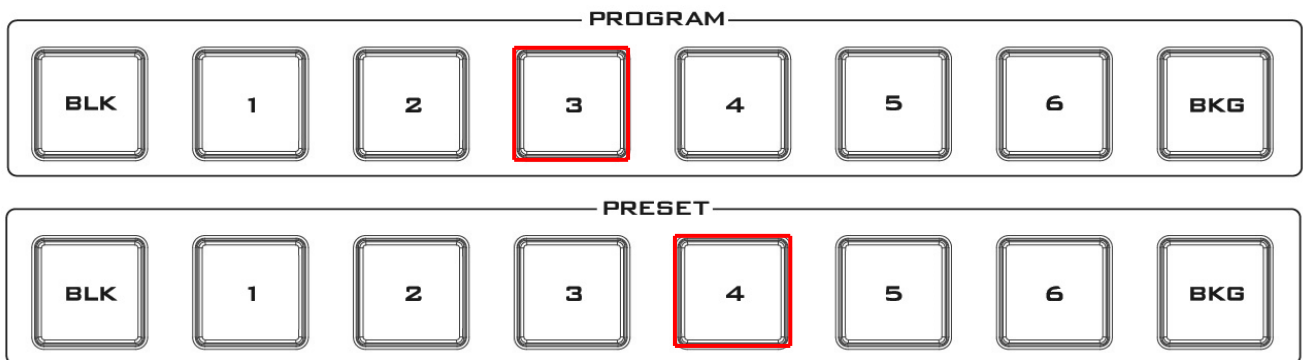

12. Press **Key 1 PGM** and **Key 2 PVW** buttons to enable views of Camera 1 and Camera 2 on Program and Preview display respectively. To trigger transition, simply move the **T-bar** manually or press the **AUTO** button.

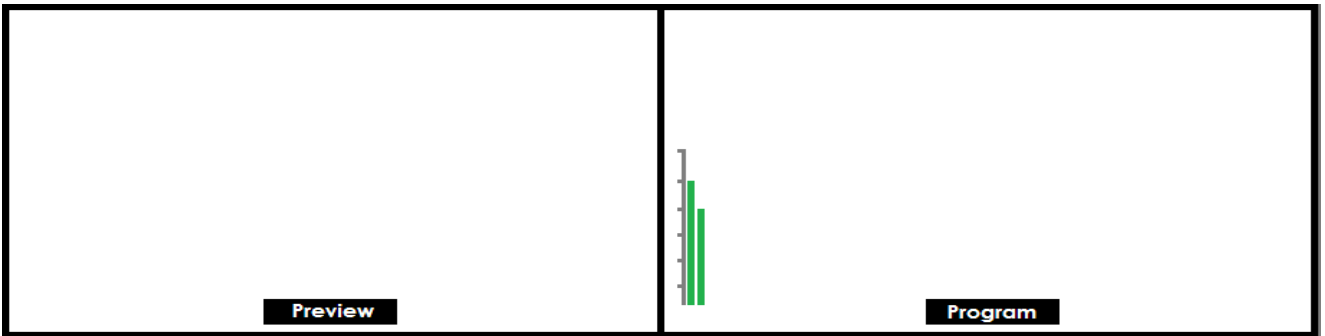

6.5 User Memory

The user memory allows the user to save the current switcher settings to different presets. You will be able to import/export these memory presets from/to the PC. In this section, we will show you how you can import and export these user memory presets step by step.

Export/Import User Memory Preset to/from the PC

1. On the **Switcher Image Import/Export** interface, click **Import-Export**.



2. After entering **the Import-Export** option, first select a preset number in the **User** option and then click **“Import User.”**

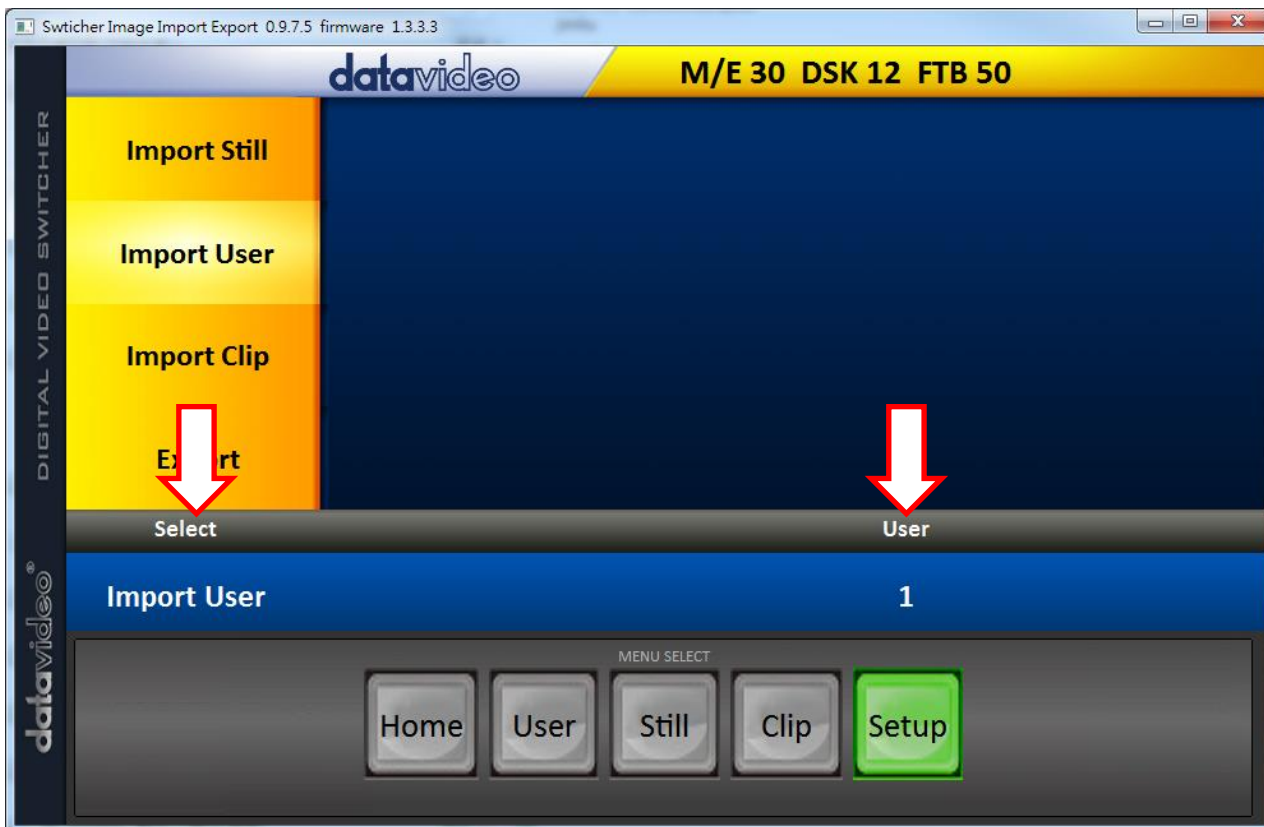

3. As soon as “Import User” is clicked, the PC hard disk browser window will open; select a .mem file to import a user settings file.

4. To export, simply click “Export” and the following window will open; select a preset number to export the user settings to the PC in .mem file. Click “Export User” to open the file browser window.

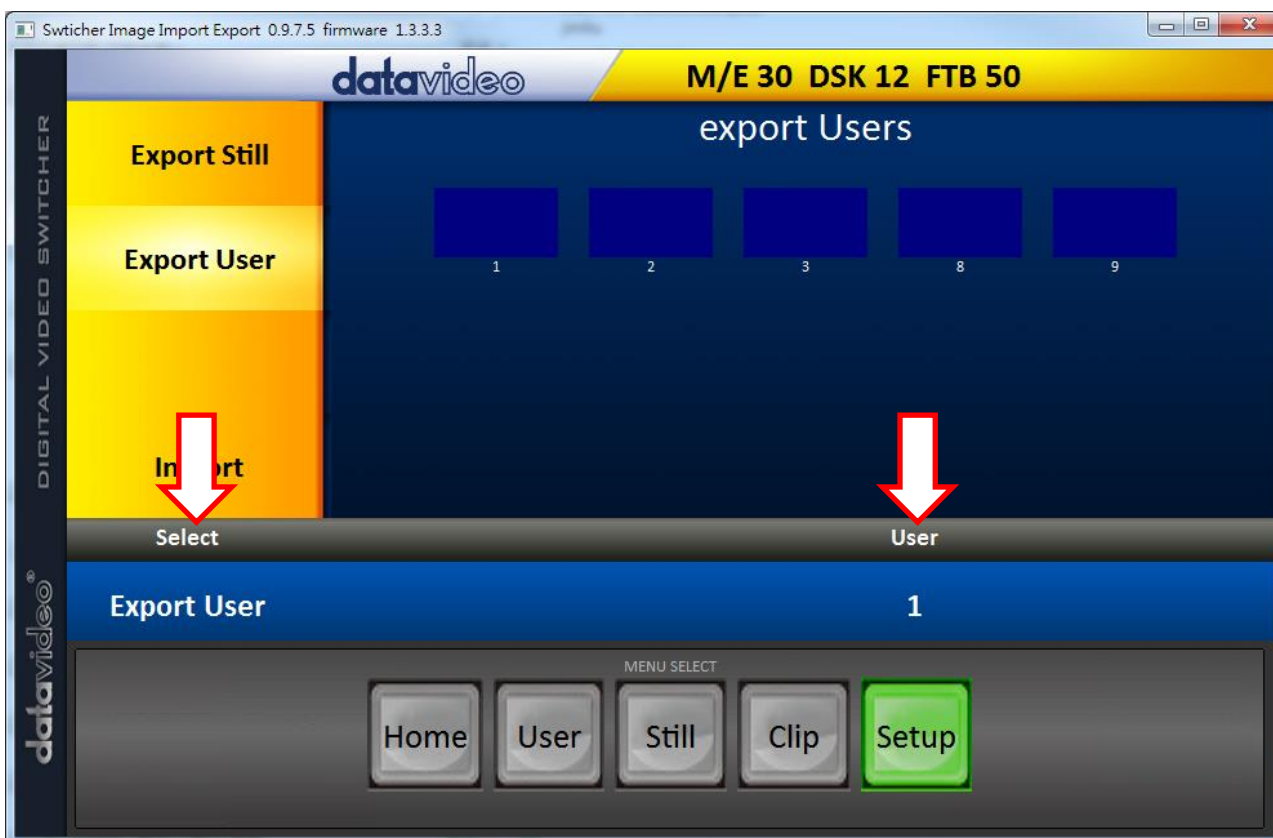

5. On the PC hard disk browser window, select a directory in which the .mem file can be saved.

Loading User Memory Preset

The HS-1300 allows the user to load user memory presets saved on the machine to the Multiview screen. Please follow the steps outlined below to load the user memory preset.

1. Press the **MENU** button to open the OSD menu on the Multiview display.
2. Open the **User Mems** menu option as shown below.

User Mems	Load Mem	Memory 13	Load	
	Save Mem	Memory 13	Save	
	Load Clip	Load	Clip 0	
		Thumbnail Picture - 1	Thumbnail Picture	Thumbnail Picture + 1

3. In the **Load Mem** sub-option, first select the **Memory Preset** that you would like to load (**Memory**).
4. Select **Load** to load the preset settings to the machine.

Chapter 7 Monitor OSD MENU Options

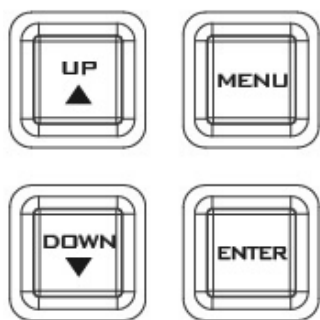

The HS-1300 Monitor can be configured via an on screen menu. When the **MENU** button is pressed the Main Menu list is displayed on the monitor.

This section covers the Menu options in the order that they appear on the monitor. These settings may also appear in more detail elsewhere in this instruction manual. Options may vary depending on the firmware version in use.

Once the chosen setting has been confirmed with the **ENTER** button, it is stored within the switcher's non-volatile memory.

Main Options	Sub Options	Parameters	Parameters
MAIN ADJUST	BRIGHTNESS	0~100	
	CONTRAST	0~100	
	SHARPNESS	0~100	
	SATURATION	0~100	
	TINT	0~100	
	BACK LIGHT	0~100	
	NR	HIGH / MID / LOW / OFF	
	MPEG NR	HIGH / LOW / OFF	
	VOLUME	0~100	
	EXIT		
COLOR	6500		
	9300		
	7500		
	USER COLOR	RED	0~100
		GREEN	0~100
		BLUE	0~100
EXIT			
SCAN SETTING	UNDER SCAN	full image	
	OVER SCAN	cropped image	
INFORMATION	H. FREQUENCY		
	V. FREQUENCY		
	RESOLUTION		
	VER.		
LANGUAGE	English [default]		
	Francis		
	Deutsch		
	Español		
	Italiano		
	Dutch		
	Português		
	Russian		
EXIT			
SPECIAL FUNCTION	OSD TIMOUT	5-120 SEC	
	FRAME RATIO	80 / 90 / OFF	
	4:3 MARK LINE	ON / OFF	
	CENTRAL MARK	ON / OFF	
	CINEMA ZONE MARK	ON / OFF	
	EXIT		
FACTORY RESET			
EXIT			

7.1 Main Adjust

The first menu option is the **MAIN ADJUST**.

To access the MAIN ADJUST sub-menu, press enter and the Brightness sub-option will be highlighted.

To adjust **BRIGHTNESS** press Enter again. Use the Up / Down buttons to change the setting and then press Enter to store the new value and return to the main menu.

Use the Up / Down buttons to select a different setting (Brightness, Contrast, Saturation, Sharpness, TINT and etc). Follow the same procedure to set other values.

7.2 Color

Press the MENU button to access the menu and use the Up / Down buttons to move to the **COLOR** option so that it is highlighted. Press the **ENTER** button to open the COLOR sub-menu.

To access the selected color setting, press **ENTER** again.

Use the Up / Down buttons to navigate the available color settings.

You can choose:

7500
9300
6500
USER COLOR

7.3 Information

The **System Information** Menu displays Horizontal Frequency, Vertical Frequency, Resolution and the monitor's version of firmware.

Once selected, the information will be displayed as follows:

You will see:	H. FREQUENCY	33.7KHZ
	V. FREQUENCY	60.0HZ
	RESOLUTION	1920X1080I
	VER.	0.11

7.4 Special Function

The Special Function Sub-Menu has settings for the **OSD TIMEOUT**, **Frame Ratio**, **4:3 MARK LINE**, **Central Mark**, and **Cinema Zone Mark**.

To access the selected setting press the **ENTER** button.

Use the Up / Down buttons to navigate the available options.

You can choose:	OSD TIMEOUT	5-120 SEC
	FRAME RATIO	90 / 80 / OFF
	4:3 MARK LINE	ON / OFF
	CENTRAL MARK	ON / OFF
	CINEMA ZONE MARK	ON / OFF

7.5 Factory Reset

The monitor menu offers a Factory Reset option, which will return all the settings of the monitor to the factory defaults

To reset the monitor press the MENU button and then use the UP / Down button to navigate to **FACTORY RESET** option. Press **ENTER** again to reset the monitor. After a few seconds the monitor will be reset.

Appendices

Switcher Firmware Update Procedure

From time to time Datavideo may release new firmware to either add new features or to fix reported bugs in the current HS-1300 firmware. Customers can update the firmware themselves if they wish or they can contact their local dealer or reseller for assistance should they prefer this method.

This page describes the firmware update process and it should take *approximately few minutes to complete*.

A working HS-1300 requires the following:

- The latest firmware update for the **HS-1300** (This firmware file can be obtained from your local Datavideo office or dealer).
- HS-1300 x 1
- 12V Power adapter x 1
- USB thumb drive x 1
- USB A connector cable x 1

Once started *the update process should not be interrupted in any way* as this could result in a non-responsive unit.

1. Locate the FW Upgrade USB port on the front panel of the HS-1300.



2. Insert the USB stick containing the latest firmware to the FW upgrade port.
3. Power on the device and the device should automatically detect the connected USB storage device.
4. Press the **"MENU"** button on the control panel to open the menu on the monitor screen.
5. Press the **"down arrow"** button to scroll to the **"Setup"** Option.
6. Press the **"ENTER"** button to enter the **"Setup"** menu.
7. Press the **"down arrow"** button to scroll to **"Software"** and then press the **"ENTER"** button to select the **"Software"** option.
8. As soon as **"Software"** is selected, you will be prompted whether to start the Software Upgrade. Select **YES** if you would like to start the software upgrade.
9. Reboot the device after the upgrade process is complete.

GPI Connection

The HS-1300 can control external recorder/playback devices via simple contact closure GPI switch.

The GPI interface is a 3.5mm Jack Socket which is situated on the rear panel of the HS-1300. Contact closure between the Outer and Inner contacts on the jack plug will trigger a user selected event. Power is supplied by the HS-1300 and is less than 5V DC.

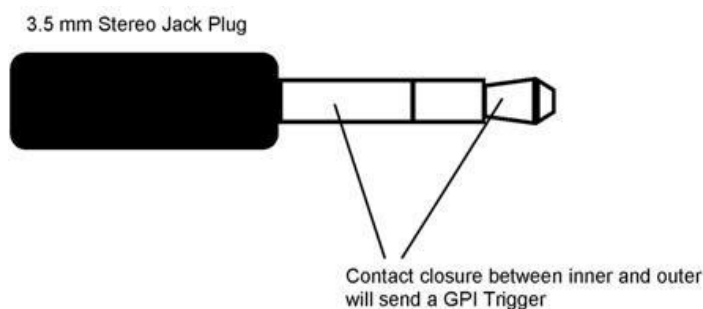

This GPI socket can also be used as a socket to trigger record or playback events with other equipment such as the Datavideo HDR-70 recorder.

SAFETY FIRST The cabling required needs to be designed specifically to connect the HS-1300 to the chosen record or playback device as they are not all the same. The cabling required can be made by yourself or a competent technician. Please speak with your Dealer or local Datavideo office to get further help and advice.

Tally Outputs

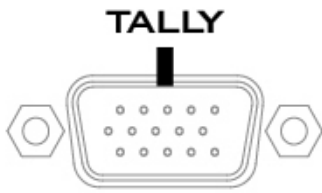

The HS-1300 has a D-sub 15 pin female tally output port. These connections provide bi-colour tally information to a number of other Datavideo products, such as the ITC-100 eight channel talkback system and the TLM range of LCD Monitors.

The ports are open collector ports and as such do not provide power to tally light circuits.

The pin outputs are defined as follows:

PIN No.	Signal Name	Input/Output	Description of Signal
1	Program 1	Open collector output	Tally output of input video Program 1
2	Program 5	Open collector output	Tally output of input video Program 5
3	Preview 1	Open collector output	Tally output of input video Preview 1
4	RCOM (GND)	Ground	Ground
5	Program 4	Open collector output	Tally output of input video Program 4
6	Program 2	Open collector output	Tally output of input video Program 2
7	Program 6	Open collector output	Tally output of input video Program 6
8	Preview 2	Open collector output	Tally output of input video Preview 2
9	GND	Ground	Ground
10	Preview 5	Open collector output	Tally output of input video Preview 5
11	Program 3	Open collector output	Tally output of input video Program 3
12	Preview 6	Open collector output	Tally output of input video Preview 6
13	Preview 3	Open collector output	Tally output of input video Preview 3
14	YCOM (GND)	Ground	Ground
15	Preview 4	Open collector output	Tally output of input video Preview 4

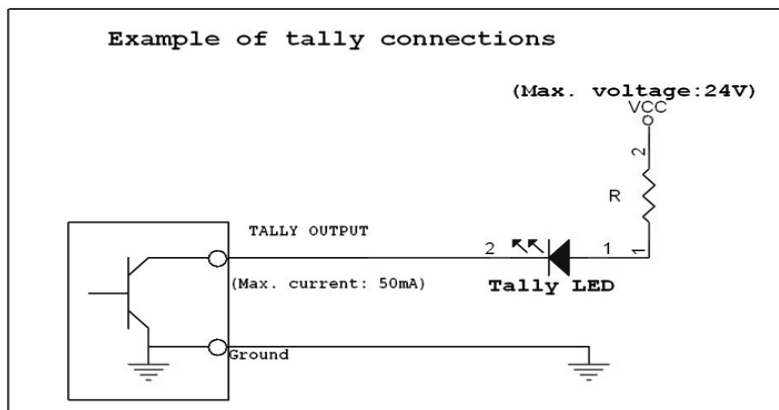

Frequently-Asked Questions

This section describes problems that you may encounter while using HS-1300. If you have any questions, please refer to related sections and follow all suggested solutions. If problem still exists, please contact your distributor or the service center.

No.	Problems	Solutions
1.	What is the maximum bit rate of the HS-1300?	Depending on the purpose of use, the device's maximum bit rate varies: Record-Only: 16 Mbps Stream-Only: 10 Mbps Stream and Record: sum of the two video bitrates should not exceed 12Mbps
2.	What are the appropriate SD card classes?	Use any of the SD Card Classes C10/U1/V10.
3.	a. Why am I still seeing lag delay in the video recorded on SD Card Class C10?	a. This could be due to unoptimized disk formatting. Format your disk on the NVS-31 or using the tool downloaded from the SD association's official website (https://www.sdcard.org/cht/downloads/formatter_4/index.html).
	b. In this case, why doesn't the system issue any error messages as soon as video recording is started?	b. The system detects and sets the write speed as soon as the video recording is started and insufficient write speed is experienced while the video is being recorded.
4.	Why am I seeing blurry images while the video is being streamed over the RTSP protocol?	1. The maximum streaming resolution offered on the NVS-31 is 1080p60 so try viewing the streamed video on another computer. 2. Change your video source to 1080i (the switcher output) and lower the bitrate. 3. This could be due to insufficient network capacity. Use a Gigabit switch or router.
5.	The recorded video file cannot be played if recording is stopped due to system crash or power failure.	This is the limitation of MP4 files, which cannot be played as long as the recording is stopped incorrectly. It is recommended to use other video formats to record or repair the file using certain software tools.
6	How to retrieve the device IP if I do not remember the network settings or the network settings are lost?	If you do not remember the IP address assigned to the device, follow the steps below to reset the network settings: <ul style="list-style-type: none"> • Turn off the machine. • Press the RECORD and STREAM buttons simultaneously and switch ON the device. • Wait for 5 seconds approximately and release the button push as soon as the two buttons light up. • The default IP address is 192.168.1.60.
7	How to remove the clip stored in the CH6 buffer after the Clip transition is disabled?	You should first clear the clip buffer using the Delete Clip option in the User Mems sub menu, and then set CH6 to live or still in the Inputs sub menu.

Dimensions

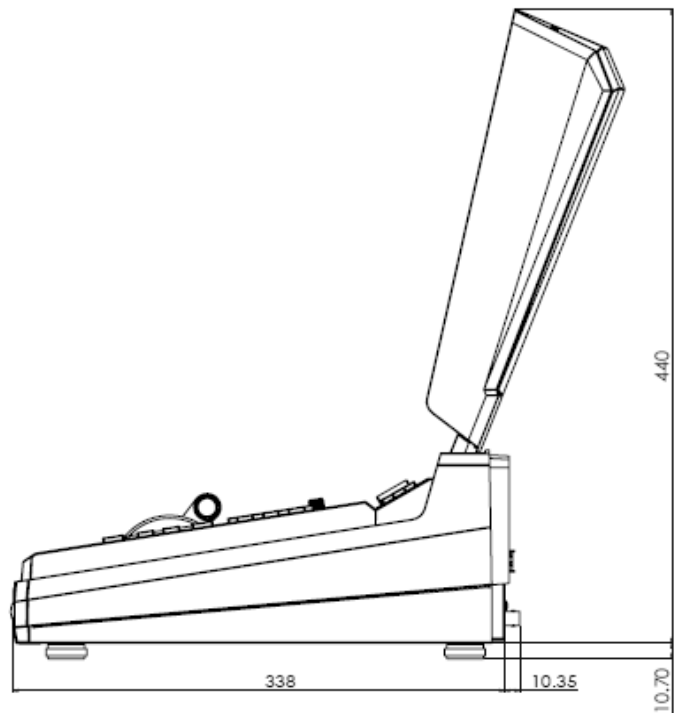
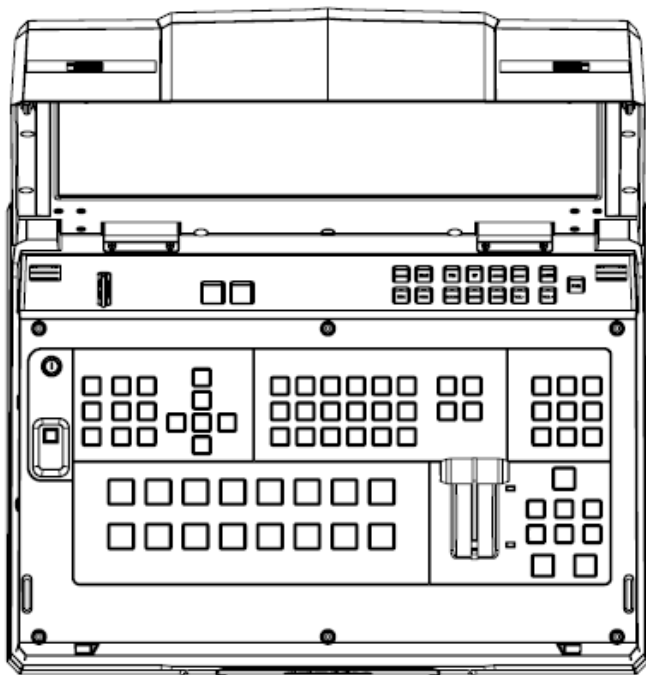
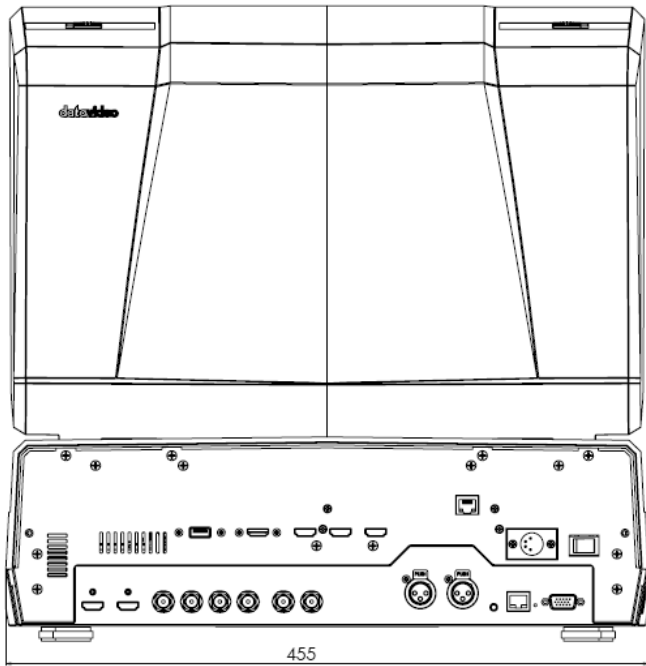

All measurements in millimetres (mm)

Specifications

Connections	
Total Video Inputs	Total 6 inputs 2 HDMI (RGB/YVU, 1080P/1080I/720P) 4 SDI (1080I/720P)
Monitor External Input	1 HDMI
Total Outputs	3 HDMI + 2 SDI
SDI Audio Output (PGM output)	2CH
Audio Input	2 x XLR (2 x Analogue)
Internal Frame Synchronizers	All 6 Inputs
PGM Out	HDMI / SDI
Multi view Out	HDMI (720P -> 720P ; 1080i->1080P) SDI (720P -> 720P ; 1080i->1080i)
SDI Output	Select any from the following input sources PROGRAM (w/ DSK 1 & 2) PROGRAM (w/ DSK 1) Clean PROGRAM PREVIEW (w/o DSK) MULTISCREEN Input 1~6
HDMI OUT	HDMI OUT 1/2/3 are fixed to PGM
Audio Indicator on Multi view	Y (output 2CH)
Streaming	1 x RJ-45 (100/1000M Ethernet)
Storage	1x SD Card Slot Supports SD, SDHC and SDXC card (UHS-I) (Class 10 highly recommended).
Computer Output	Ethernet (Motion JPEG Out)
Tally Out	Y
GPI	Two mode: Level /Pulse trigger selectable
Speaker Volume Control	Control Knob
Switcher Software Updates	USB Port (Rear)
Monitor	
LCD Display	17.3" TFT LCD
Resolution	RGB 1600 x 900 pixel
Aspect Ratio	4:3 and 16:9 selectable
LED Life time	15,000 hrs. (approx.)
Brightness (Luminance)	220 cd/m ²
Contrast Ratio	650:1
View Angle	Top : 20 deg / Bottom : 45 deg Left : 45 deg / Right : 45 deg
Video System	NTSC / PAL auto recognition
Colour Adjustment	Brightness, Contrast, Color Saturation

Standards	
Format Support	1080i 50/ 59.94/ 60Hz, 720p 50/ 59.94/ 60Hz,
SDI Compliance	SMPTE 292M (SDI output /PGM out)
Video Sampling	4:2:2 10 bit
Color Precision	4:2:2 10 bit
Color Space	4:2:2 YUV
HDMI Input Resolutions for Computers	1280 x 720 59.94Hz 50Hz (720P) and 1920 x 1080 59.94Hz 50Hz (1080p & 1080i)
Processing	
Colorspace Conversion	Hardware based real time
Processing Delay	< 1 frame
Audio Mixer	Selectable audio follow video Master gain control
HD Down Conversion	N/A
Extras	
Upstream Keyers	2 (M/E Keyer & PIP)
Downstream Keyers	2
Linear/Luma Keyers	4
Chroma Keyers	2 (M/E Keyer & PIP)
Pattern Generators	Color Bar
PIP	1
XPT	Y
Frame store	Any Input can be used as Frame store. 8 Still frames stored in local frame buffers for instant access.
Control Panel Compatibility	Use PC via Ethernet; Control Panel
Input Voltage	8V~17V
Multi View Monitoring	
Number of Windows	2 (PGM, PVW) +6 (Inputs 1-6) +2 Output windows (SDI1, SDI2)
Routable Windows	Y (Follow XPT)
Tally	Y
Windows Source Labels	Y
Streaming Function	
Video Encode	<ul style="list-style-type: none"> • H.264 / AVC, Main/ High Profile • Configurable Bit-rate up to 10Mbps
Audio Encode	<ul style="list-style-type: none"> • AAC-LC • Configurable bit rate range from 32Kbps to 384Kbps • Sample rate: 48KHz, 16bit

Streaming Protocol	<ul style="list-style-type: none"> • TS over TCP/UDP (unicast & multicast) • RTSP over HTTP/TCP/UDP (RTSP Elementary Streaming) • RTMP (Publish)
Control	<p>Web browser UI for configuration and control</p> <p>Socket commands</p>
Recording File System	<p>FAT</p> <p>exFAT</p>
Recording File Format	MP4
Setting Control	Web UI for system configuration and control
Applications	<ul style="list-style-type: none"> • Youtube • Live House • UStream • Akamai • Facebook • Twitch • Wowza • Adobe Media Server

Service & Support

It is our goal to make owning and using Datavideo products a satisfying experience. Our support staff is available to assist you to set up and operate your system. Contact your local office for specific support requests. Plus, please visit www.datavideo.com to access our FAQ section.

China Shanghai
Datavideo Technologies China Co
601, Building 10, No. 1228,
Rd. Jiangchang,
Jingan District, Shanghai
Tel: +86 21-5603 6599
Fax: +86 21-5603 6770
E-mail: service@datavideo.cn

China Beijing
Datavideo Technologies China Co
No. 812, Building B, Wankai Center,
No. 316, Wan Feng Road, Fengtai District,
Beijing, China
Tel: +86 10-8586 9034
Fax: +86 10-8586 9074
E-mail: service@datavideo.cn

China Chengdu
Datavideo Technologies China Co
B-823, Meinian square, No. 1388,
Middle of Tianfu Avenue, Gaoxin District,
Chengdu, Sichuan
Tel: +86 28-8613 7786
Fax: +86 28-8513 6486
E-mail: service@datavideo.cn

China Fuzhou
Datavideo Technologies China Co
A1-2318-19 Room, No. 8, Aojiang Road,
Taijiang District, Fuzhou, Fujian, China
Tel: 0591-83211756 · 0591-83210187
Fax: 0591-83211262
E-mail: service@datavideo.cn

China Jinan
Datavideo Technologies China Co
902, No. 1 business building,
Xiangtai Square, No. 129,
Yingxiongshan Road, Shizhong District,
Jinan City, Shandong Province, China
Tel: +86 531-8607 8813
E-mail: service@datavideo.cn

Hong Kong
Datavideo Hong Kong Ltd
G/F., 26 Cross Lane
Wanchai, Hong Kong
Tel: +852-2833-1981
Fax: +852-2833-9916
E-mail: info@datavideo.com.hk

India Noida
Datavideo India Noida
A-132, Sec-63, Noida-201307,
India
Tel: +91-0120-2427337
Fax: +91-0120-2427338
E-mail: sales@datavideo.in

India Kochi
Datavideo India Kochi
2nd Floor- North Wing, Govardhan Building,
Opp. NCC Group Headquarters, Chittoor Road,
Cochin- 682035
Tel: +91 4844-025336
Fax: +91 4844-047696
E-mail: sales@datavideo.in

Netherlands
Datavideo Technologies Europe BV
Floridadreef 106
3565 AM Utrecht,
The Netherlands
Tel: +31-30-261-96-56
Fax: +31-30-261-96-57
E-mail: info@datavideo.nl

Singapore
Datavideo Visual Technology(S) Pte Ltd
No. 178 Paya Lebar Road #06-07
Singapore 409030
Tel: +65-6749 6866
Fax: +65-6749 3266
E-mail: info@datavideovirtualset.com

Singapore
Datavideo Technologies (S) PTE Ltd
No. 178 Paya Lebar Road #06-03
Singapore 409030
Tel: +65-6749 6866
Fax: +65-6749 3266
E-mail: sales@datavideo.sg

Taiwan
Datavideo Technologies Co. Ltd
10F. No. 176, Jian 1st Rd., Chung Ho
District, New Taipei City 235, Taiwan
Tel: +886-2-8227-2888
Fax: +886-2-8227-2777
E-mail: service@datavideo.com.tw

United States
Datavideo Corporation
7048 Elmer Avenue,
Whittier, CA 90602,
U.S.A.
Tel: +1-562-696 2324
Fax: +1-562-698 6930
E-mail: sales@datavideo.com

United Kingdom
Datavideo UK Limited
Brookfield House, Brookfield Industrial
Estate, Peakdale Road, Glossop,
Derbyshire, SK13 6LQ
Tel: +44-1457 851 000
Fax: +44-1457 850 964
E-mail: sales@datavideo.co.uk

France
Datavideo France s.a.r.l.
Cit  Descartes 1, rue Albert Einstein
Champs sur Marne 774477 –
Marne la Vall e cedex 2
Tel: +33-1-60370246
Fax: +33-1-60376732
E-mail: info@datavideo.fr



Please visit our website for latest manual update.

http://www.resource.datavideo.com/manuals/Datavideo_HS-1300.pdf

datavideo
www.datavideo.com