



AX-Edge

Owner's Manual



About the AX-Edge's manuals

Owner's Manual  (This document),  (The latest version of the PDF is available on the web.)

Read this first. It explains the basic things you need to know in order to use the AX-Edge.

Parameter Guide 
This explains all parameters of the AX-Edge.

Sound List 
This is a list of the sounds built into the AX-Edge.

MIDI Implementation 
This is detailed information about MIDI messages.

To obtain the PDF manual

- 1 Access <https://www.roland.com/support/>
- 2 In the Support menu, choose "Owner's Manual"
- 3 Choose "AX-Edge"

Before using this unit, carefully read "USING THE UNIT SAFELY" and "IMPORTANT NOTES" (the leaflet "USING THE UNIT SAFELY" and the Owner's Manual (p. 22)). After reading, keep the document(s) where it will be available for immediate reference.

Contents

Introduction	3	Using Other Performance Functions	13
◇ Overview of the AX-Edge	3	◇ Performing Along with an Audio File from a USB Flash Drive (Song Player)	13
Panel Descriptions	4	◇ Playing Arpeggios (Arpeggio)	13
◇ Top Panel	4	◇ Using the Vocoder (Vocoder)	14
◇ Bottom Panel	5	Editing the Vocoder Settings	14
Installing the Batteries	5	Adjusting the Mic Sensitivity	14
◇ Rear Panel	6	◇ Using the AX-Edge as a Master Keyboard	15
Connecting External Equipment	7	Editing the Sound	16
◇ Turning the AX-Edge On	8	◇ Editing the System Effects	16
Turning Off the Power	8	◇ Editing a Program	16
◇ Adjusting the Overall Volume (Master Volume)	8	Saving a Program (Program Write)	16
◇ Making the Power Automatically Turn Off After a Time (Auto Off)	8	Connecting External Equipment	17
◇ Replacing the Blade Panel	8	◇ Connecting a MIDI Device (MIDI IN/OUT Connectors)	17
Playing	9	◇ Connecting a Computer (USB COMPUTER Port)	17
◇ Selecting a Sound (Program)	9	Attaching the Ferrite Core	17
◇ Registering Frequently-Used Sounds to Buttons (FAVORITE)	9	◇ Connecting a Bluetooth® Device	17
Registering a Favorite	9	Other Functions	18
Recalling a Favorite	9	◇ Checking the Remaining Battery Charge	18
Switching the Favorite Bank	9	◇ Convenient Functions (UTILITY)	18
Using the Performance Functions	10	◇ Returning to the Factory Settings (FACTORY RESET)	18
◇ Using the Buttons and Controllers	10	◇ Backing Up Data to USB Flash Drive (BACKUP)	19
Raising/Lowering the Key Range (Octave Shift)	10	◇ Restoring Backup Data (RESTORE)	19
Smoothly Changing the Pitch (Portamento)	10	◇ Formatting a USB Flash Drive (FORMAT USB MEMORY)	20
Sustaining the Notes (Hold)	10	◇ Editing the System Settings (SYSTEM)	20
Layering the Same Tone to Thicken the Sound (Unison)	11	Saving the System Settings (System Write)	20
Preventing the Sound from Changing During Performance (Lock)	11	Viewing the Program Version (VERSION INFO)	20
◇ Modifying the Sound While You Perform	11	Main Specifications	21
Using the MODULATION BAR	11	USING THE UNIT SAFELY	22
Using the RIBBON CONTROLLER	11	IMPORTANT NOTES	22
Using the Control Buttons and Knob ([S1]–[S7] Buttons / [ASSIGNABLE CONTROL] Knob)	12		
Using a Pedal	12		
Modifying the Sound by Applying Further Pressure to the Key (Aftertouch)	12		
◇ Assigning the Function of Each Controller	12		

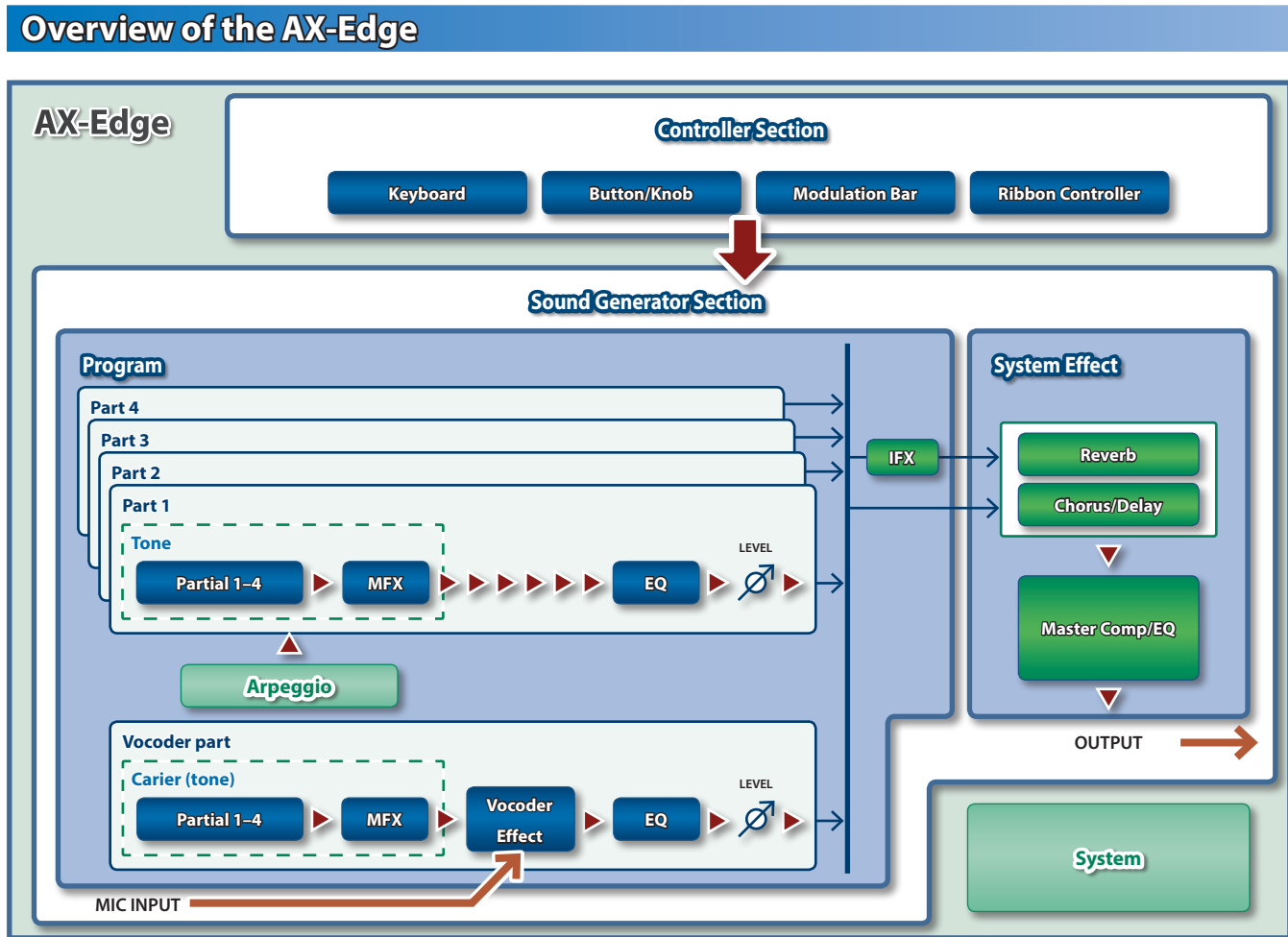

Controller Section

The controller section is what you use for performing.

When you press or release the keyboard or press the modulation lever, the controller section sends performance data to the sound generator section.

The controller section of the AX-Edge consists of the keyboard, the **MODULATION BAR**, the **RIBBON CONTROLLER**, and the panel buttons and knobs.

Sound Generator Section

The sound generator section creates the sound.

It receives performance data sent from the controller section, and produces sound.

Program

On the AX-Edge, "**programs**" are the units by which you switch sounds.

A program consists of four parts and a vocoder part, and also contains arpeggio and effect settings for that program.

Tone

You can select one tone (sound) for each part.

A tone consists of four elements of sound (partials), and you can specify a multi-effect (MXF) for each tone.

You can also edit tones by using an editor app (AX-Edge Editor) on your smartphone.

Effect

The AX-Edge is equipped with a multi-effect for each tone (MXF), a multi-effect that can be specified for each program (IFX), and reverb, chorus/delay, compressor, and EQ effects that are applied to the final output (system effects).

Reverb and chorus/delay can also be specified and selected for each program.

System

System memory contains system parameter settings that specify how the AX-Edge is to operate.

➔ "**Editing the System Settings (SYSTEM)**" (p. 20)

Panel Descriptions

Top Panel



1 Display

Bank/number display

A three-digit display that shows the bank and number of the currently selected sound.

LCD display

Shows various information for the operation.

2 Basic operation buttons

Cursor [◀] [▶] buttons

Move the cursor left/right.

These also switch screens.

[–] [+] buttons

Modify values.

If you keep on holding down one button while pressing the other, the value change accelerates.

[EXIT] button

Returns you to the previous screen.

In some screens, this cancels the operation currently being executed.

[ENTER] button

Press this to confirm a value or execute an operation.

[SHIFT] button

Used together with other buttons to execute various functions.

[MENU/WRITE] button

The MENU screen appears.

Use this together with the **[SHIFT] button** to save sounds or system settings (p. 12, p. 20).

3 FAVORITE

page 9

FAVORITE [ON] button

Turns the FAVORITE function on/off.

FAVORITE [BANK] button

Selects the bank of FAVORITE memories (p. 9) in which you can register your favorite sounds (programs).

4 PROGRAM buttons

page 4

[EDGE LEAD]–[VOCODER/VOICE] buttons [0]–[9] buttons

Select the category of sounds (programs).

When the **[FAVORITE] button** or the **[BANK] button** is lit, these function as **[0]–[9] buttons**.

5 SONG PLAYER

page 13

SONG PLAYER [LIST] button

Displays the song list.

SONG PLAYER [▶/■] button

Plays/stops the selected song.

6 ARPEGGIO/LOCK

page 13

[ARPEGGIO] button

Turns the arpeggio function on/off.

[LOCK] button

page 11

Long-press this button to turn panel lock on/off (a function that disables panel operations).

7 Neck control section (Top Panel)

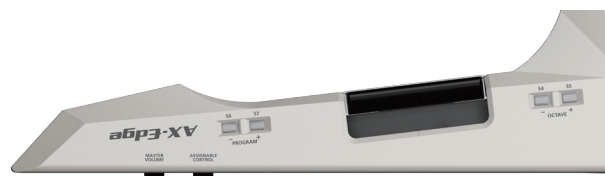

[MASTER VOLUME] knob

Adjusts the overall volume.

[ASSIGNABLE CONTROL] knob

Controls the parameter that's assigned to the knob.

PROGRAM [–] [+] buttons ([S6], [S7] buttons)

page 9

Each time you press a button, the sound (program) is switched consecutively.

If the Favorite function is on, you'll switch consecutively through the sounds that are registered as Favorites.

MODULATION BAR

page 11

Press the **MODULATION BAR** to add modulation to the notes you are playing.

RIBBON CONTROLLER

page 11

Slide your finger towards the left or right on this ribbon to change the pitch of the notes.

You can modify the sound by pressing the controller with your finger.

OCTAVE [–] [+] buttons ([S4], [S5] buttons)

page 10

These buttons are used to transpose the AX-Edge's keyboard in steps of one octave.

Bottom Panel

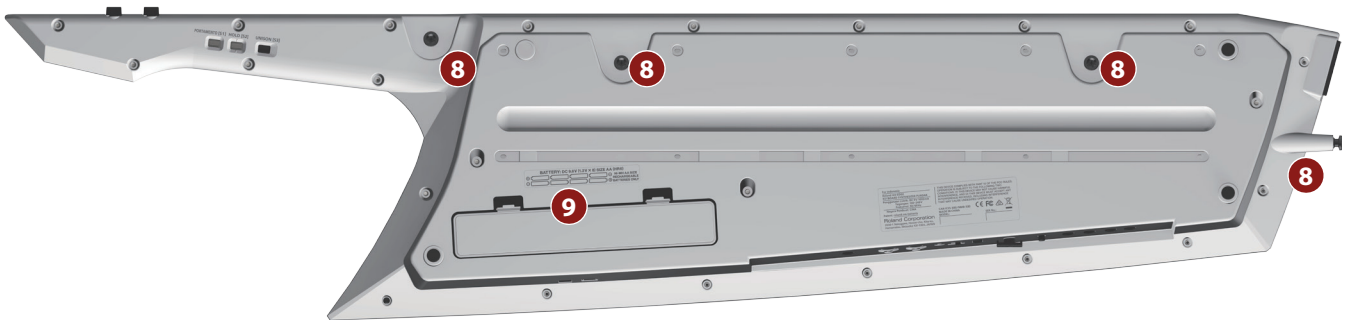

8 Strap pins

Attach the included strap here.
Choose two pin locations as appropriate for your performing style.

9 Battery compartment

Install eight AA nickel-metal hydride batteries.
→ **"Installing the Batteries"** (p. 5)

10 Neck control section (Bottom panel)

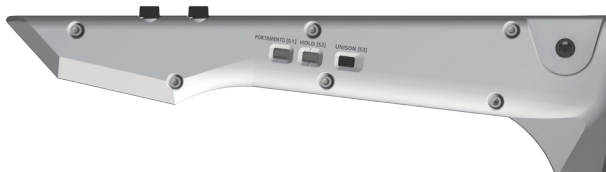

[PORTAMENTO] button ([S1] button)

page 10

Turns portamento on/off.
This produces a smooth change to the next pitch.

[HOLD] button ([S2] button)

page 10

Turns hold on/off.
This sustains the notes you play.

[UNISON] button ([S3] button)

page 11

Turns unison on/off.
This makes the sound richer by layering the same tone.

* You can change the parameters that are controlled by the [S1]–[S7] buttons, MODULATION BAR, RIBBON CONTROLLER, control knob, and pedal.
For details, refer to **"Assigning the Function of Each Controller"** (p. 12).

Installing the Batteries

Eight AA batteries are required to run the AX-Edge on battery power. We recommend the use of rechargeable AA-type Ni-MH batteries. With these batteries you can expect about four hours of continuous operation, although this depends on how the AX-Edge is being used.

- * When turning the unit over, be careful so as to protect the buttons and knobs from damage. Also, handle the unit carefully; do not drop it.
- * If you handle batteries improperly, you risk explosion and fluid leakage. Make sure that you carefully observe all of the items related to batteries that are listed in **"USING THE UNIT SAFELY"** and **"IMPORTANT NOTES"** (leaflet **"USING THE UNIT SAFELY"** and Owner's manual (p. 22)).

1. Turn off the power of the AX-Edge (p. 8).
2. While pressing inward on the tabs of the bottom panel battery compartment cover, remove the cover.

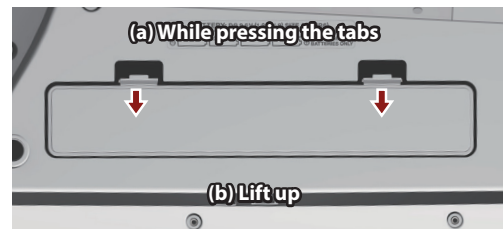

3. Insert the batteries into the battery compartment, taking care to observe the "+" and "-" polarity.

Be sure that the "+" and "-" markings on the batteries are oriented correctly.

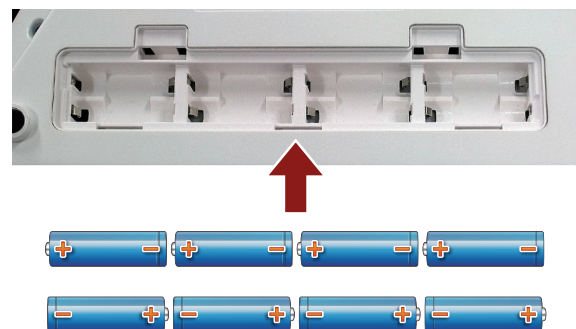

4. Close the battery compartment cover.

Rear Panel

* To prevent malfunction and equipment failure, always turn down the volume, and turn off all the units before making any connections.

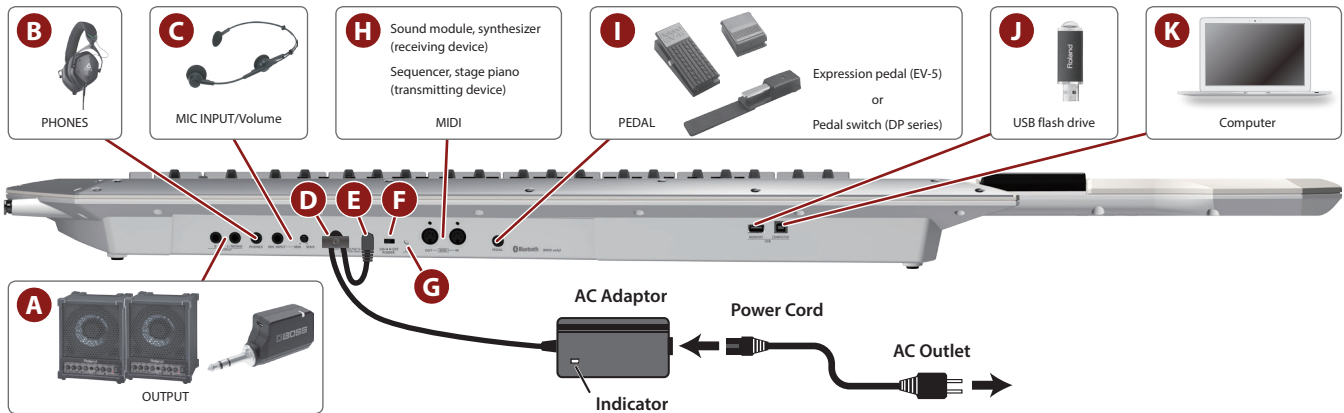

A OUTPUT (L/MONO, R) jacks

These are output jacks for audio signals. Connect them to your amp or wireless transmitter.
Use the L/MONO jack if you're outputting in mono.

B PHONES jack

You can connect a set of headphones here.

C MIC INPUT

MIC INPUT jack

Connect a dynamic microphone here.

[MIC INPUT Volume] knob

Adjusts the volume of the mic input.

D Cord hook

If the included AC adaptor is connected to the DC IN jack, secure the cord to this hook to prevent it from being accidentally disconnected.

* Use the cord hook to secure the cord of the AC adaptor as shown in the illustration.

E DC IN jack

Connect the included AC adaptor here.

* Place the AC adaptor so the side with the indicator (see illustration) faces upwards and the side with textual information faces downwards. The indicator will light when you plug the AC adaptor into an AC outlet.

* Use only the included AC adaptor. Using any other adaptor may result in malfunctions or electric shock.

* We recommend that you keep batteries installed in the unit even though you'll be powering it with the AC adaptor. That way, you'll be able to continue a performance even if the cord of the AC adaptor gets accidentally disconnected from the unit.

* If you won't be using the unit for an extended period of time, disconnect the AC adaptor from the AC outlet.

F [POWER] switch

This turns the power on/off.

* Before turning the unit on/off, always be sure to turn the volume down. Even with the volume turned down, you might hear some sound when switching the unit on/off. However, this is normal and does not indicate a malfunction.

G Ground terminal

Depending on the circumstances of a particular setup, you may experience a discomforting sensation, or perceive that the surface feels gritty to the touch when you touch this device, microphones connected to it, or the metal portions of other objects, such as guitars. This is due to an infinitesimal electrical charge, which is absolutely harmless. However, if you are concerned about this, connect the ground terminal (see figure) with an external ground. When the unit is grounded, a slight hum may occur, depending on the particulars of your installation. If you are unsure of the connection method, contact the nearest Roland Service Center, or an authorized Roland distributor, as listed on the "Information" page.

Unsuitable places for connection

- Water pipes (may result in shock or electrocution)
- Gas pipes (may result in fire or explosion)
- Telephone-line ground or lightning rod (may be dangerous in the event of lightning)

H MIDI (IN/OUT) port

Used for connecting external MIDI devices and for transmission of MIDI messages.

I PEDAL jack

Connect a separately sold Roland DP series or EV-5 pedal.

* Use only the specified expression pedal. By connecting any other expression pedals, you risk causing malfunction and/or damage to the unit.

J USB MEMORY port

You can connect a USB flash drive here.

Connect or disconnect the USB flash drive while the AX-Edge is powered-off.

* Use a commercially available USB flash drive or a USB flash drive sold by Roland. However, we cannot guarantee that all commercially available USB flash drives will work with this unit.

K USB COMPUTER port

Use a USB cable to connect this port to a USB port of your computer.

This allows the AX-Edge to operate as a USB MIDI device. There's no need to install a driver.

Connecting External Equipment

Connecting to an amp or mixer

The AX-Edge does not have an internal amp or speakers. In order to produce sound, you'll need to connect it to an audio device such as a keyboard amp, monitor speakers, or a stereo set, or use headphones.

1. Connect the rear panel OUTPUT jacks to the input jacks of your external device.

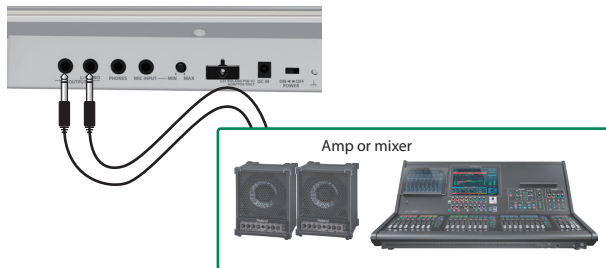

Make connections using a 1/4" unbalanced (mono) cable. Use a cable that has the appropriate type of plug for connecting to the input jack of your device.

- * If you're using a mono audio device, connect the cable to the L/MONO OUTPUT jack.

If you're using headphones, connect them to the PHONES jack. In this case there's no need to connect any other audio device.

Connecting via a wireless system to an amp, etc.

If you use a commercially available wireless system and operate the AX-Edge on batteries, you'll be able to perform while moving around on stage free of any cables.

- * Be sure to use a wireless transmitter that complies with the wireless regulations that are applicable in your area.

1. Connect the wireless transmitter to the rear panel OUTPUT jacks.

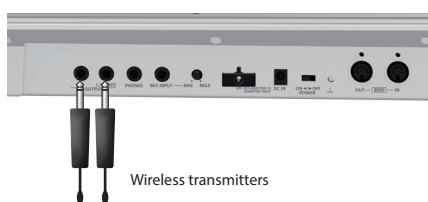

- * The shape of the connector depends on the wireless transmitter that you're using.
- * If the amp that you're using has only a mono channel, connect only one transmitter to the L/MONO jack of the AX-Edge.

2. Connect the audio output of the wireless receiver to your mixer or amp.

Controlling a MIDI sound module

1. Connect the AX-Edge's MIDI OUT connector to the MIDI IN connector of the sound module or synthesizer that you want to control.

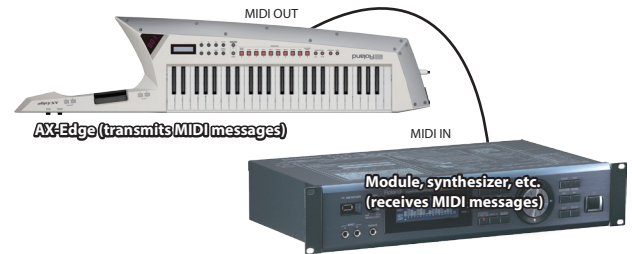

- * As needed, connect the sound module or synthesizer to your amp or speaker. For details, refer to the owner's manual of the sound module or synthesizer that you're using.

Controlling the AX-Edge from an external MIDI device

The AX-Edge can receive MIDI messages and produce sound using the program that's selected on its sound generator.

1. Connect the MIDI OUT connector of your controlling device to the AX-Edge's MIDI IN connector.

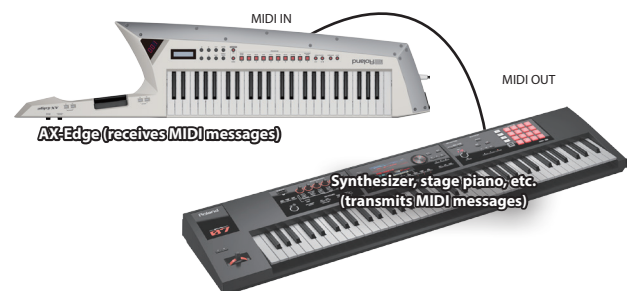

MEMO

To specify the MIDI transmit/receive channels, edit the system parameters Basic Channel and Program Control Channel. If you're using the master keyboard function, edit the program parameters to specify the MIDI transmit channel of each part.

For details, refer to "Parameter Guide" (PDF).

Connecting a computer or sequencer

If you want to connect the AX-Edge to a computer in which you've installed sequencer software or a software sound module, and use the AX-Edge as a master keyboard to record or perform, make connections as follows.

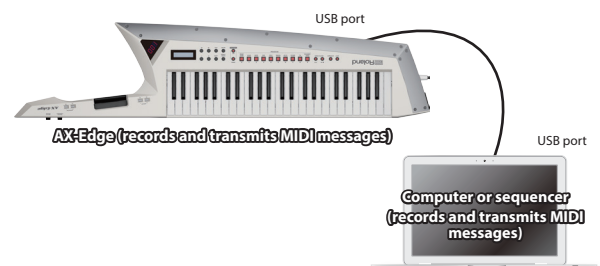

Turning the AX-Edge On

1. Power-on the equipment in the order of AX-Edge → connected devices.

* In order to protect its circuitry, the AX-Edge waits for a while after being powered-on before it begins operating.

2. Switch on power to the connected equipment, and raise the volume to an appropriate level.

* The power to this unit will be turned off automatically after a predetermined amount of time has passed since it was last used for playing music, or its buttons or controls were operated (Auto Off function).

If you do not want the power to be turned off automatically, disengage the Auto Off function.

→ **"Making the Power Automatically Turn Off After a Time (Auto Off)"** (p. 8)

- Unsaved data is lost when the power turns off. Before turning the power off, save the data that you want to keep.
- To restore power, turn the power on again.

Turning Off the Power

1. Power-off the equipment in the order of the connected devices → AX-Edge.

Adjusting the Overall Volume (Master Volume)

Adjusts the overall volume.

1. Adjust the **[MASTER VOLUME]** knob located in the neck control section.

Making the Power Automatically Turn Off After a Time (Auto Off)

1. Press the **[MENU/WRITE]** button.
2. Use the cursor [**◀**] [**▶**] buttons to select **"SYSTEM,"** and then press the **[ENTER]** button.
3. Use the cursor [**◀**] [**▶**] buttons to select **"Auto Off,"** and use the [**-**] [**+**] buttons to change the setting.

If you don't want the unit to turn off automatically, choose **"OFF"** setting.

Parameter	Value
Cursor [◀] [▶]	[-] [+]
Auto Off	OFF, 30min, 240min

4. To save the setting, hold down the **[SHIFT]** button and press the **[MENU/WRITE]** button.

A confirmation message appears.

```
Write System ?
[Exit]:N [Ent]:Y
```

* Save the system settings while the system setting screen is displayed. You can't write the system settings unless you're in the system setting screen.

5. To execute, press the **[ENTER]** button.

If you decide to cancel, press the **[EXIT]** button.

Replacing the Blade Panel

The AX-Edge comes with one replacement blade panel.

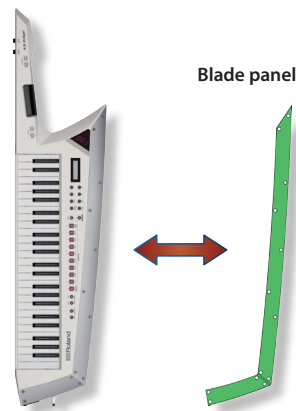

1. Use the included hex key to remove the screws.
2. Exchange the blade panel.
3. Attach the screws.

NOTE

Tightening the screws excessively could damage the panel or the AX-Edge itself. Take care not to tighten the screws excessively.

Playing

English

日本語

Deutsch

Français

Italiano

Español

Português

Nederlands

Selecting a Sound (Program)

The sounds (programs) of the AX-Edge are organized into ten category, with 32 programs in each category.

1. Press the [EDGE LEAD]–[VOCODER/VOICE] buttons to select the category.

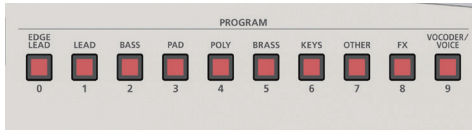

2. Use the [-] [+] buttons to switch programs.

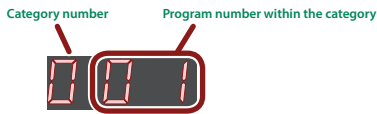

MEMO

- If you keep on holding down one button while pressing the other, the value change accelerates.
- You can also switch categories by holding down the [SHIFT] button and using the [-] [+] buttons.
- You can switch programs by using the PROGRAM [-] [+] buttons located in the neck control section.

Registering Frequently-Used Sounds to Buttons (FAVORITE)

“Favorite” is a function that lets you register frequently-used sounds (programs) so that they can be recalled by a single button. The Favorite registers the number of the program.

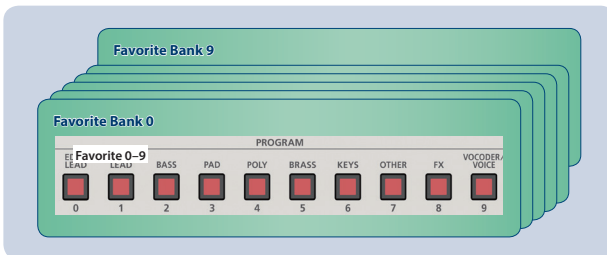

MEMO

- With Favorites 0–9 as one set, you can register a total of ten sets in the Favorite banks.
- Use the ten buttons [0]–[9] to recall or register programs.

NOTE

If you're editing a program, save that program first before you register it as a Favorite.

Registering a Favorite

1. Select the program that you want to register.
2. Press the FAVORITE [BANK] button to make it light.
3. Press a [0]–[9] button to select the registration-destination bank.
4. Hold down the FAVORITE [ON] button and press the [0]–[9] button in which you want to register the program.

The currently selected program is registered to that button.

Recalling a Favorite

1. Press the FAVORITE [ON] button to make it light.

The [0]–[9] buttons act as Favorite select buttons.

When the FAVORITE function is on, the bank/number display shows the following.

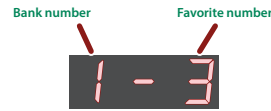

2. Press a [0]–[9] button to select a Favorite.

If you press a button in which a Favorite has not yet been registered, the screen indicates “Not Registered!”

Switching the Favorite Bank

1. Press the FAVORITE [BANK] button to make it light.

The button ([0]–[9]) corresponding to the currently selected bank blinks.

2. Press a [0]–[9] button to select a bank.

MEMO

If only the bank number is shown in the display, use the [0]–[9] buttons to select a favorite.

Using the Performance Functions

The AX-Edge provides numerous functions that you can use to make your performance more expressive, shift the pitch, etc.

Using the Buttons and Controllers

Raising/Lowering the Key Range (Octave Shift)

Here's how to shift the pitch range of the keyboard in units of an octave.

1. Press the **OCTAVE [-] or [+] button.**

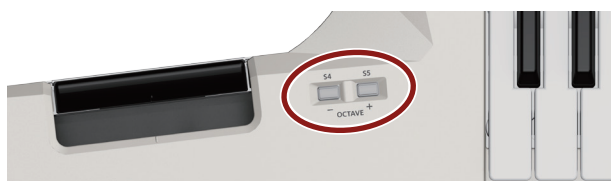

MEMO

- You can shift the pitch a maximum of ± 3 octaves. If the octave is shifted, the **OCTAVE [-] button** or **[+] button** is lit.
- To return to the original key range, press the **OCTAVE [-] button** and **[+] button** simultaneously.

Shifting the key range only while the button is held

Here's how to change the setting so that the pitch range of the keyboard is shifted one octave up or down only while you hold down the **OCTAVE [-] [+] button**. When you release the button, the keyboard returns to its normal pitch range.

- Press the **[MENU/WRITE] button**.
- Use the **cursor [◀] [▶] buttons** to select "**SYSTEM,**" and then press the **[ENTER] button**.
- Use the **cursor [◀] [▶] buttons** to select "**S4 (M),**" and use the **[-] [+] buttons** to change the value to "**MOMENTARY.**"
- Next, use the **cursor [◀] [▶] buttons** to select "**S5 (M),**" and use the **[-] [+] buttons** to change the value to "**MOMENTARY.**"

Menu	Parameter Cursor [◀] [▶]	Value [-] [+]
CTRL BUTTON	S4 (M)	MOMENTARY: The octave is shifted up/down only while you hold down the button.
	S5 (M)	LATCH: The octave is shifted up/down each time you press the button (maximum of ± 3 octaves).

5. If you want to save the setting, execute the System Write operation.

➔ "**Saving the System Settings (System Write)**" (p. 20)

- * You can assign a function other than **OCTAVE [-] [+]** to these buttons. For details on how to assign a function to these buttons, refer to "**Assigning the Function of Each Controller**" (p. 12).

Smoothly Changing the Pitch (Portamento)

Portamento is a function that smoothly changes the pitch from that of the first-played key to that of the next-played key.

Portamento turns on/off each time you press the **[PORTAMENTO] button**.

MEMO

The way in which portamento is applied differs depending on the settings of the selected tone.

Applying portamento only while you hold down the button

Here's how to make portamento turn on only while the **[PORTAMENTO] button** is held down. When you release the button, portamento turns off.

- Press the **[MENU/WRITE] button**.
- Use the **cursor [◀] [▶] button** to select "**SYSTEM,**" and then press the **[ENTER] button**.
- Use the **cursor [◀] [▶] buttons** to select "**S1 (M),**" and use the **[-] [+] buttons** to change the value to "**MOMENTARY.**"

Menu	Parameter Cursor [◀] [▶]	Value [-] [+]
CTRL BUTTON	S1 (M)	MOMENTARY: Portamento is on only while you hold down the button. LATCH: Portamento turns on/off each time you press the button.

4. If you want to save the setting, execute the System Write operation.

➔ "**Saving the System Settings (System Write)**" (p. 20)

- * You can assign a function other than **[PORTAMENTO]** to this button. For details on how to assign a function to this button, refer to "**Assigning the Function of Each Controller**" (p. 12).

Sustaining the Notes (Hold)

This function sustains the notes you play on the keyboard, just like the damper pedal of an acoustic piano.

Hold is on while you hold down the **[HOLD] button**. When you play a note and press the **[HOLD] button**, the notes are sustained.

Using the button to switch hold on/off

Here's how to make Hold switch on/off each time you press the **[HOLD] button**.

- Press the **[MENU/WRITE] button**.
- Use the **cursor [◀] [▶] buttons** to select "**SYSTEM,**" and then press the **[ENTER] button**.
- Use the **cursor [◀] [▶] buttons** to select "**S2 (M),**" and use the **[-] [+] buttons** to change the value to "**LATCH.**"

Menu	Parameter Cursor [◀] [▶]	Value [-] [+]
CTRL BUTTON	S2 (M)	MOMENTARY: The hold function is on only while you hold down the button. LATCH: The hold function turns on/off each time you press the button.

4. If you want to save the setting, execute the System Write operation.

➔ **"Saving the System Settings (System Write)"** (p. 20)

* You can assign a function other than [HOLD] to this button. For details on how to assign a function to this button, refer to **"Assigning the Function of Each Controller"** (p. 12).

Layering the Same Tone to Thicken the Sound (Unison)

If you turn **"Unison"** on, the sound is thickened by layering an identical but slightly pitch-shifted tone onto the tone of part 1. Unison turns on/off each time you press the [UNISON] button.

MEMO

- The depth of the effect differs depending on the settings of the tone that's selected.

Turning unison on only while you hold down the button

Here's how to make the unison function turn on only while you hold down the [UNISON] button. When you release the button, unison turns off.

1. Press the [MENU/WRITE] button.
2. Use the cursor [◀] [▶] buttons to select **"SYSTEM,"** and then press the [ENTER] button.
3. Use the cursor [◀] [▶] buttons to select **"S3 (M),"** and use the [-] [+] buttons to change the value to **"MOMENTARY."**
4. If you want to save the setting, execute the System Write operation.
 - ➔ **"Saving the System Settings (System Write)"** (p. 20)
 - * You can assign a function other than [UNISON] to this button. For details on how to assign a function to this button, refer to **"Assigning the Function of Each Controller"** (p. 12).

Preventing the Sound from Changing During Performance (Lock)

You can disable some of the AX-Edge's buttons to prevent the sound from being inadvertently switched if you press a button accidentally.

1. Hold down the [LOCK] button until it is lit.

The lock function turns on, and the buttons other than in the neck control section are disabled.

To return to the normal state, once again hold down the [LOCK] button until it is unlit.

MEMO

- The lock function does not apply to the buttons of the neck control section.
- The lock function is valid only in the top screen (the program select screen).

Modifying the Sound While You Perform

The AX-Edge lets you use various controllers to modify the sound while you perform.

Using the MODULATION BAR

Press the **MODULATION BAR** to apply modulation.

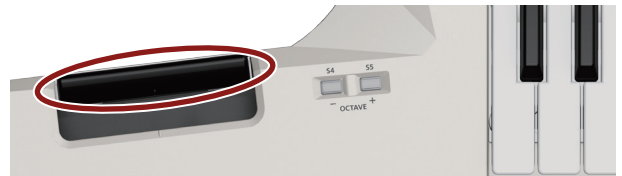

* The effect applied by the **MODULATION BAR** differs depending on the setting. Normally, pressing the **MODULATION BAR** applies a vibrato effect. To change the setting, refer to **"Assigning the Function of Each Controller"** (p. 12).

Using the RIBBON CONTROLLER

You can modify the sound by pressing your finger on the **RIBBON CONTROLLER** and moving it to left or right. For this controller, the sound also changes according to the pressure of your finger.

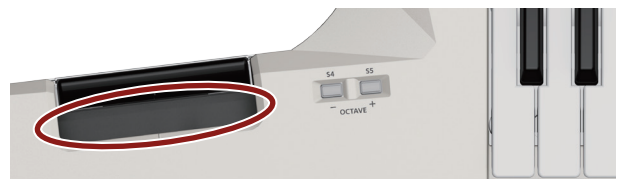

* The effect applied by the **RIBBON CONTROLLER** differs depending on the setting. Normally, left/right motion operates as pitch bend to change the pitch. Pressure on the controller applies a vibrato-type effect. To change the setting, refer to **"Assigning the Function of Each Controller"** (p. 12).

Disabling the RIBBON CONTROLLER

You can disable the AX-Edge's **RIBBON CONTROLLER** operations if you like. This is convenient when you want to apply an effect only in response to left/right movement or only in response to pressure.

1. Press the [MENU/WRITE] button.
2. Use the cursor [◀] [▶] buttons to select **"SYSTEM,"** and then press the [ENTER] button.
3. Use the cursor [◀] [▶] buttons to select a parameter, and use the [-] [+] buttons to change the value.

Menu	Parameter	Value
[SHIFT] + cursor [◀] [▶]	Cursor [◀] [▶]	[-] [+]
CTRL RIBBON	Posi (Position)	OFF: Left/right operation is disabled.
	Pres (Pressure)	OFF: Pressure operation is disabled.

Various other settings are also available. For details, refer to **"Parameter Guide"** (PDF).

MEMO

- If you want to save the setting, execute the System Write operation.
 - ➔ **"Saving the System Settings (System Write)"** (p. 20)
- Depending on the settings of the program, operation might not be disabled even if you change the system settings. For details, refer to the parameter guide.

Using the Control Buttons and Knob ([S1]–[S7] Buttons / [ASSIGNABLE CONTROL] Knob)

You can assign various parameters to the control buttons ([S1]–[S7] buttons) and the [ASSIGNABLE CONTROL] knob of the neck control section, and use them to modify the sound.

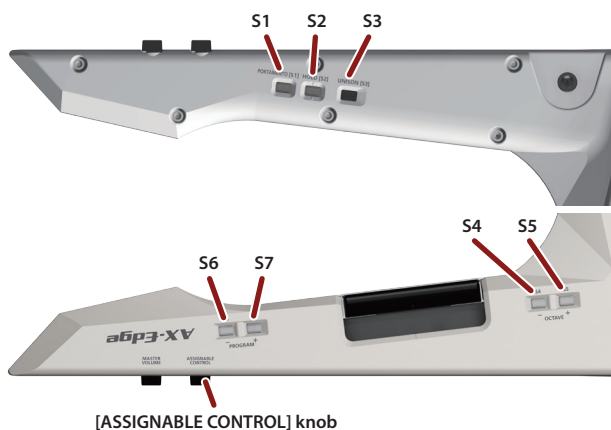

For each control button and knob, you can specify what happens when the controller is operated. For details, refer to “Assigning the Function of Each Controller” (p. 12).

MEMO

The knob value does not automatically return to its original state, so if you don't want to apply the effect, return the knob to “0.”

Using a Pedal

You can assign various parameters to a pedal switch or expression pedal connected to the PEDAL jack, and use the switch or pedal to modify the sound or control a function.

The effect controlled by the pedal differs depending on the setting. You can specify the effect of operating a pedal switch or expression pedal. For details, refer to “Assigning the Function of Each Controller” (p. 12).

Modifying the Sound by Applying Further Pressure to the Key (Aftertouch)

The keyboard of the AX-Edge is equipped with an aftertouch sensor. You can modify the sound by applying pressure to the keyboard.

The effect applied by aftertouch differs depending on the tone parameter setting.

This needs to be specified using the “AX-Edge Editor” software.

For details, refer to “AX-Edge Editor’s manual.”

Assigning the Function of Each Controller

You can change the parameters that are controlled by the [S1]–[S7] buttons, MODULATION BAR, RIBBON CONTROLLER, control knob, and pedal.

1. Press the [MENU/WRITE] button.
2. Use the cursor [◀] [▶] button to select “SYSTEM,” and then press the [ENTER] button.
3. Use the cursor [◀] [▶] buttons to select a parameter, and use the [-] [+] buttons to change its value.

Menu	Parameter Cursor [◀] [▶]	Value [-] [+]
CTRL BUTTON	S1 (F) –S7 (F)	Specify the parameters that are assigned to the [S1]–[S7] buttons.
	S1 (M) –S7 (M)	Specify the operating mode of the [S1]–[S7] buttons. MOMENTARY: The function is on only while you hold down the button. LATCH: The function turns on/off each time you press the button.
CTRL KNOB	Func	Specifies the parameter that is assigned to the [ASSIGNABLE CONTROL] knob.
CTRL PEDAL	Func	Specifies the parameter that is assigned to the pedal.
	Pole	Specifies the polarity of the pedal.
CTRL RIBBON	Posi	Specifies the parameter that is assigned to the RIBBON CONTROLLER (left/right direction).
	Pres	Specifies the parameter that is assigned to the RIBBON CONTROLLER (pressure).
CTRL MOD BAR	Func	Specifies the parameter that is assigned to the MODULATION BAR.

For details, refer to “Parameter Guide (English)” (PDF).

4. If you want to save the setting, execute the System Write operation.

➔ “Saving the System Settings (System Write)” (p. 20)

MEMO

The settings of these controllers can be specified and remembered individually for each program. This is convenient when you want to switch the controller assignments for each sound (program). In the program control parameters, change each controller's Source (Src) from System (SYS) to Program (PRG).

For details, refer to “Parameter Guide” (PDF).

Using Other Performance Functions

English

日本語

Deutsch

Français

Italiano

Español

Português

Nederlands

Performing Along with an Audio File from a USB Flash Drive (Song Player)

You can copy an audio file (MP3 or WAV) from your computer to a USB flash drive, and perform on the AX-Edge while that audio file plays back.

1. Format your USB flash drive on the AX-Edge.

- ➔ **“Formatting a USB Flash Drive (FORMAT USB MEMORY)”** (p. 20)

MEMO

- Use a commercially available USB flash drive or a USB flash drive sold by Roland. However, we cannot guarantee operation with all commercially available flash drives.
- We recommend that you use single-byte alphanumeric characters for the file name. If you use double-byte characters, the file name will not be shown correctly in the display.

2. Copy the audio file into the “SONG LIST” folder.

Audio files that can be played

MP3	
Format	MPEG-1 audio layer 3
Sampling Frequency	48 kHz
Bit rate	32/40/48/56/64/80/96/112/128/160/192/224/ 256/320 kbps, VBR (Variable Bit Rate)
WAV	
Sampling Frequency	48 kHz
Bit Depth	16/24-bit

* For both MP3 and WAV, the only sampling frequency supported is 48 kHz.

If your file has a sampling frequency of other than 48 kHz, use software on your computer to convert it to 48 kHz beforehand.

3. Connect the USB flash drive to the USB MEMORY port of the AX-Edge.

4. Press the SONG PLAYER [LIST] button.

The LCD display shows the audio files.

5. Use the cursor [◀] [▶] buttons to select a song.

NOTE

If the name of the audio file contains double-byte characters, it is not shown correctly in the LCD display.

6. Press the SONG PLAYER [▶/■] button to play.

Press the SONG PLAYER [▶/■] button once again to stop.

MEMO

- Use the [-] [+] buttons to adjust the volume of the song.
- If you want to save the volume setting, execute the System Write operation.

- ➔ **“Saving the System Settings (System Write)”** (p. 20)

Playing Arpeggios (Arpeggio)

To turn on the arpeggio function, press the [ARPEGGIO] button to make it light.

An **“arpeggio”** is a performance technique in which the notes of a chord are played at different times.

1. Press the [ARPEGGIO] button to make it light.

2. Hold down keys on the keyboard.

An arpeggio plays.

Editing the arpeggio

Arpeggio settings are saved individually for each program.

1. Hold down the [SHIFT] button and press the [ARPEGGIO] button.

MEMO

You can also access the same screen by pressing the [MENU/WRITE] button and selecting **“ARPEGGIO.”**

2. Use the cursor [◀] [▶] buttons to select the item that you want to edit.

3. Use the [-] [+] buttons to edit the value.

For details on the parameters, refer to **“Parameter Guide (English)”** (PDF).

4. If you want to save the setting, execute the Program Write operation.

- ➔ **“Saving a Program (Program Write)”** (p. 16)

5. Press the [EXIT] button several times to return to the top screen.

MEMO

To change the tempo of the arpeggio, change the tempo of the program. You can also specify that the tempo does not change even if you switch programs. For details, refer to **“Parameter Guide (English)”** (PDF).

Using the Vocoder (Vocoder)

The **"Vocoder"** adds effects to a human voice. If you run your voice through the vocoder, you can give it a toneless, robotic tone. Control the pitch by playing the keyboard.

- * Acoustic feedback could be produced depending on the location of microphones relative to speakers. This can be remedied by:
 - Changing the orientation of the microphone(s).
 - Relocating microphone(s) at a greater distance from speakers.
 - Lowering volume levels.

1. Connect a microphone to the rear panel MIC INPUT jack.

NOTE

The AX-Edge supports only dynamic microphones. It does not support condenser microphones.

2. Use the rear panel [MIC INPUT Volume] knob to adjust the volume.

Make detailed adjustments to the MIC INPUT volume after you select the sound (program).

Initially, set the knob to approximately the center position.

3. Press the [VOCODER/VOICE] button.

4. Use the [-] [+] buttons to select a sound (program).

Programs whose name starts with **"Voc:"** have their parameters set to use the vocoder.

5. While playing the keyboard, vocalize into the microphone.

Use the MIC INPUT volume to make fine adjustments to the volume.

Editing the Vocoder Settings

1. Press the [MENU/WRITE] button.

2. Use the cursor [◀] [▶] buttons to select "VOCODER," and then press the [ENTER] button.

3. Use the cursor [◀] [▶] buttons to select a parameter, and use the cursor [-] [+] buttons to edit the value.

For details on the parameters, refer to **"Parameter Guide (English)"** (PDF).

4. If you want to save the setting, execute the Program Write operation.

Vocoder settings are saved individually for each program.

➔ **"Saving a Program (Program Write)"** (p. 16)

5. Press the [EXIT] button several times to return to the top screen.

Adjusting the Mic Sensitivity

Depending on the environment in which you're performing, noise from the surroundings might be picked up by the mic, causing the vocoder to not work as you intend.

In this case, adjust the microphone sensitivity so that it is less likely to pickup noise.

1. Press the [MENU/WRITE] button.

2. Use the cursor [◀] [▶] buttons to select "SYSTEM," and then press the [ENTER] button.

3. Use the cursor [◀] [▶] buttons to select a parameter, and use the [-] [+] buttons to edit the value.

Menu [SHIFT] + cursor [◀] [▶]	Parameter Cursor [◀] [▶]	Value [-] [+]
MIC	NS Sw	OFF, ON: Noise suppressor on/off (suppresses noise during times of silence)
	NS Thrs	0-127: Volume at which noise suppression begins
	NS Rls	0-127: Time from when noise suppression begins until the volume reaches 0

4. If you want to save the setting, execute the System Write operation.

➔ **"Saving the System Settings (System Write)"** (p. 20)

Using the AX-Edge as a Master Keyboard

For each part within a program, you can make settings for controlling an external MIDI sound module.

This lets you use a single AX-Edge to independently control the unit itself and an external sound module.

1. Press the [MENU/WRITE] button.
2. Use the cursor [◀] [▶] buttons to select "PROGRAM CTRL," and then press the [ENTER] button.
3. Use the cursor [◀] [▶] buttons to select "TxMode" and use the [-] [+] buttons to change the setting.

Menu [SHIFT] + cursor [◀] [▶]	Parameter Cursor [◀] [▶]	Value [-] [+]
MIDI OUT	TxMode	<p>ON: This is the usual setting. The same MIDI messages are transmitted to the internal sound generator of the AX-Edge and to the external MIDI device.</p> <p>Tone selection and switching messages (bank select and program change) are the settings of the tone that is selected for that part.</p> <p>OFF: Choose this setting if you don't want a specific part to transmit MIDI messages to an external MIDI device.</p> <p>MKB: Choose this setting if you want to use the AX-Edge as a master keyboard that controls an external MIDI device.</p>

You can make this setting individually for each part.

4. To switch parts, press a [1]–[4] button.

When part 1 is selected, the upper right of the LCD display shows "P1." When part 2 is selected, the display shows "P2."

Specifying Parameters to Control an External MIDI Device

Within PROGRAM CTRL, you can specify the following parameters to control an external MIDI device.

Parameter Cursor [◀] [▶]	Value [-] [+]	Explanation
MkbCH (MKB MIDI Channel)	OFF, 1–16	Specifies the MIDI channel for transmission.
MSB (Bank Select MSB)	OFF, 0–127	Enter numeric values for the program number and bank select MSB/LSB to switch sounds on the external MIDI device.
LSB (Bank Select LSB)	OFF, 0–127	
PC (Program Change)	OFF, 1–128	
MkbVOL (Volume)	OFF, 0–127	Adjusts the volume of the external MIDI device.

5. If you want to save the setting, execute the Program Write operation.

Master keyboard settings are saved individually for each program.

➔ "Saving a Program (Program Write)" (p. 16)

Editing the Sound

The AX-Edge has three types of sound-related editing.

Program edit

Here you can edit parameters for a program. These parameters include the on/off setting and level adjustment of each part, effect settings for each program, and vocoder settings.

System effect edit

Here you can edit settings for the effects that apply to the overall output sound (system effects).

The system effects provide chorus/delay, reverb, EQ, and compressor.

Tone edit

Here you can edit tone-related parameters.

Tone edit is not possible on the AX-Edge itself. Use the dedicated smartphone app “AX-Edge Editor” to edit these parameters.

For details, refer to “AX-Edge Editor.”

NOTE

The edited settings will disappear unless you save (write) them. If you want to keep the settings, save them as follows.

To save tone edit settings, use AX-Edge Editor.

Editing the System Effects

1. Press the [MENU/WRITE] button.
2. Use the cursor [◀] [▶] buttons to select “SYSTEM EFFECT,” and then press the [ENTER] button.
3. Use the cursor [◀] [▶] buttons to select a parameter, and use the [-] [+] buttons to edit the value.

For details, refer to “Parameter Guide (English)” (PDF).

4. To save the changes, hold down the [SHIFT] button and press the [MENU/WRITE] button.

The SYSTEM WRITE confirmation screen appears.

```
Write System ?  
[Exit]:N [Ent]:Y
```

5. To execute, press the [ENTER] button.

If you decide to cancel, press the [EXIT] button.

MEMO

To save the system effect settings, execute the Write operation while you're in the system effect setting screen. You can't save system effect settings from other screens.

Editing a Program

1. Press the [MENU/WRITE] button.
2. Use the cursor [◀] [▶] buttons to select “PROGRAM SOUND” or “PROGRAM CTRL,” and press the [ENTER] button.
3. Use the cursor [◀] [▶] buttons to select a parameter, and use the [-] [+] buttons to edit the value.

For details, refer to “Parameter Guide (English)” (PDF).

Saving a Program (Program Write)

4. To save the changes, hold down the [SHIFT] button and press the [MENU/WRITE] button.

The program name input screen appears.

```
PROG NAME [Ent]  
InitProg
```

5. Use the cursor [◀] [▶] buttons to move the cursor, and use the [-] [+] buttons to change the character.

6. When you finish specifying the name, press the [ENTER] button.

A screen appears where you can select the save-destination program.

7. Use the [-] [+] buttons to select the save-destination program.

The lower line of the screen shows the program name of the save-destination.

When you save, the program is overwritten and the previous data is lost.

8. Press the [ENTER] button.

A confirmation message appears.

9. To execute, press the [ENTER] button.

If you decide to cancel, press the [EXIT] button.

NOTE

Changes you make to the program you're editing are lost if you turn off the power while editing or select another program. If you want to keep your settings, save the program.

Connecting External Equipment

Connecting a MIDI Device (MIDI IN/OUT Connectors)

If the AX-Edge is connected to an external MIDI device, performance data (MIDI message) can be transmitted and received so that the devices can control each other.



- ➔ For details on the settings that specify how performance data is transmitted and received, refer to **"Parameter Guide"** (PDF).
- ➔ For details on the MIDI messages that can be transmitted and received, refer to **"MIDI Implementation"** (PDF).
- ➔ If you want to control an external device via MIDI, refer to **"Using the AX-Edge as a Master Keyboard"** (p. 15).

Connecting a Computer (USB COMPUTER Port)

MIDI messages can be exchanged with a computer via the AX-Edge's USB port. When connecting the AX-Edge to a computer, there's no need to install a driver.

MEMO

- The AX-Edge does not support USB audio.
- For details on operating requirements and supported operating systems, refer to the Roland website.



- ➔ For details on the MIDI messages that can be transmitted and received, refer to **"MIDI Implementation"** (PDF).
- ➔ If you want to control an external device via MIDI, refer to **"Using the AX-Edge as a Master Keyboard"** (p. 15).

Attaching the Ferrite Core

If you use a USB cable to connect the AX-Edge to your computer, you must attach the included ferrite core. This is for the purpose of preventing electromagnetic interference; do not remove it.

1. Attach the ferrite core to the USB cable.

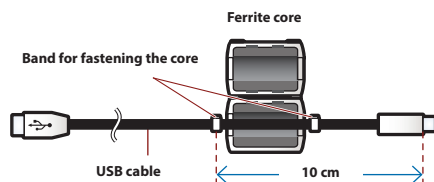

2. Press the halves together until they click shut.



- * Be careful not to pinch your fingers when attaching the ferrite core.
- * Do not damage the cable by pinching it excessively with the ferrite core.

Connecting a Bluetooth® Device

The AX-Edge's Bluetooth capability lets it connect wirelessly to a mobile device such as a smartphone or tablet (subsequently called a **"mobile device"**) so that MIDI data can be exchanged.

You can use the dedicated smartphone AX-Edge Editor app (Android version/iOS version) to edit the AX-Edge's settings.

In addition to AX-Edge Editor, you can also connect apps that support Bluetooth MIDI.

MEMO

The AX-Edge does not support Bluetooth audio.

Turning on the Bluetooth function

To connect the AX-Edge with your mobile device, turn on the AX-Edge's Bluetooth function.

1. Press the **[MENU/WRITE]** button.
2. Use the cursor [**◀**] [**▶**] buttons to select **"SYSTEM,"** and then press the **[ENTER]** button.
3. Use the cursor [**◀**] [**▶**] buttons to select **"Bluetooth,"** and use the [**-**] [**+**] buttons to change the value to **"ON."**
4. If you want to save the setting, execute the System Write operation.
 - ➔ **"Saving the System Settings (System Write)"** (p. 20)
5. Press the **[EXIT]** button several times to return to the top screen.

The Bluetooth symbol (📶) appears in the upper right of the top screen.

Connecting with the mobile device

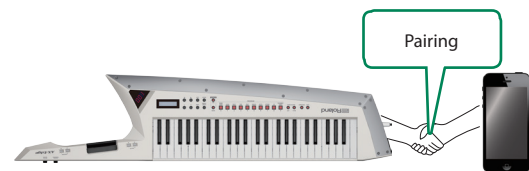

1. Locate the AX-Edge near the mobile device that you want to connect.

MEMO

If you have more than one AX-Edge unit, power-on only the unit that you want to pair (turn off the power of the other AX-Edge units).

2. Turn on the Bluetooth function of your mobile device.
3. Using the settings in your mobile device's app (e.g., **AX-Edge Editor**), connect (pair) it with the AX-Edge.

When pairing is complete, the Bluetooth symbol in the upper right of the AX-Edge's top screen is highlighted (📶 → 📶).

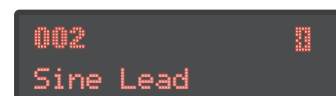

NOTE

Do not tap **"AX-Edge"** that appears in the Bluetooth settings of your mobile device. The connection will be made from within the app that you use. For details, refer to the owner's manual of the app that you're using.

Other Functions

Checking the Remaining Battery Charge

Remaining battery charge indication

Here's how to check the remaining battery charge.

1. Hold down the [SHIFT] button and press the FAVORITE [BANK] button.

The **bank/number display** shows the remaining battery charge as 0–100 (%), and the **LCD display** shows the BATTERY INFO screen.

2. Once again, hold down the [SHIFT] button and press the FAVORITE [BANK] button.

Return to the previous screen.

MEMO

You can also access the BATTERY INFO screen from the MENU.

- * The battery charge indication is only an approximation.
- * While the AC adaptor is connected, the displayed value will always be "100."

Low battery indication

When the battery charge runs low while the AX-Edge is operating on batteries, the decimal point in the lower right of the **bank/number display** is lit. Replace the batteries as soon as possible.



If you continue use, the decimal point changes from lit to flashing, and the display indicates "**Charge Battery.**" Stop using the AX-Edge, and replace the batteries.

NOTE

If you continue use after the decimal point starts flashing, the display indicates "**Battery Low!**" (the **bank/number display** indicates "**Lo**"). Further operation will be impossible, and the power turns off automatically.

- * The batteries cannot be charged while you're using the AX-Edge.
- * The remaining battery charge indication is only an approximation.

Convenient Functions (UTILITY)

Here you can back up the AX-Edge's data to a USB flash drive, or restore data from a USB flash drive back into the AX-Edge. You can also use the "**UTILITY**" functions to return the AX-Edge to its factory-set condition, or format a USB flash drive.

1. Press the [MENU/WRITE] button.
2. Use the cursor [◀] [▶] buttons to select "**UTILITY**," and then press the [ENTER] button.
3. Use the cursor [◀] [▶] buttons to select the item that you want to edit and press the [ENTER] button.

Menu	Explanation
Cursor [◀] [▶]	
BACKUP	Backs-up user data to a USB flash drive. This creates system/user settings (.SVD).
RESTORE	Restores backup data from a USB flash drive into the AX-Edge.
FACTORY RESET	Resets the AX-Edge's settings to their factory-set condition.
FORMAT USB MEMORY	Initializes a USB flash drive.

4. Select the item that you want to execute, and press the [ENTER] button.

Returning to the Factory Settings (FACTORY RESET)

Here's how the settings that you edited and saved on the AX-Edge can be returned to their factory-set condition.

- * When you execute this operation, all the settings that you modified after purchasing the AX-Edge, including the sound parameters, are lost.
- * If you will later need the current settings, be sure to use the backup function p. 19) to save the current settings before you restore the factory settings.

1. Press the [MENU/WRITE] button.
2. Use the cursor [◀] [▶] buttons to select "**UTILITY**," and then press the [ENTER] button.
3. Use the cursor [◀] [▶] buttons to select "**FACTORY RESET**," and then press the [ENTER] button.

A confirmation message appears.

If you decide to cancel, press the [EXIT] button.

4. Press the [ENTER] button.
A confirmation message appears once again.
5. To execute, press the [ENTER] button once again.
6. When the LCD display indicates "**Completed**," turn the AX-Edge's power off and on again.

Backing Up Data to USB Flash Drive (BACKUP)

Here's how to back up user data to a USB flash drive.

Data that is backed up

- All program data (including vocoder and arpeggio settings)
- User tone data
- Favorites
- System settings (including system effects)

NOTE

Never turn off the power or remove the USB flash drives while the screen indicates "Executing...."

1. Press the [MENU/WRITE] button.
2. Use the cursor [◀] [▶] buttons to select "UTILITY," and then press the [ENTER] button.
3. Use the cursor [◀] [▶] buttons to select "BACKUP," and then press the [ENTER] button.
The BACKUP NAME screen appears.
4. Use the cursor [◀] [▶] buttons to move the cursor, and use the [-] [+] buttons to select characters.
5. When you've specified the file name, press the [ENTER] button.
A confirmation message appears.
If you decide to cancel, press the [EXIT] button.
6. To execute, press the [ENTER] button.
When the backup is finished, the screen indicates "Completed!"
If a file of the same name exists, a confirmation screen (Overwrite?) asks whether you want to overwrite the existing file.

Restoring Backup Data (RESTORE)

Here's how user data that you backed-up on a USB flash drive can be returned to the AX-Edge. This operation is called "restore."

NOTE

- All user data are rewritten when you execute the restore operation. If your AX-Edge contains important data, assign it a different name and back it up to an USB flash drive before you restore.
- Never turn off the power or remove the USB flash drives while the screen indicates "Executing...."

1. Press the [MENU/WRITE] button.
2. Use the cursor [◀] [▶] buttons to select "UTILITY," and then press the [ENTER] button.
3. Use the cursor [◀] [▶] buttons to select "RESTORE," and then press the [ENTER] button.
4. Use the [-] [+] buttons to select the file that you want to restore.
5. Press the [ENTER] button.
A confirmation message appears.
If you decide to cancel, press the [EXIT] button.
6. To execute, press the [ENTER] button.
When the restore operation is finished, the screen indicates "Completed. Turn off power."
7. Turn the power of the AX-Edge off and then on again.

Formatting a USB Flash Drive (FORMAT USB MEMORY)

NOTE

- If the USB flash drive contains important data, be aware that this operation erases all data from the drive.
- Never turn off the power or remove the USB flash drives while the screen indicates “Executing....”

1. Press the [MENU/WRITE] button.
2. Use the cursor [◀] [▶] buttons to select “UTILITY,” and then press the [ENTER] button.
3. Use the cursor [◀] [▶] buttons to select “USB MEM FORMAT,” and then press the [ENTER] button.

A confirmation message appears.

If you decide to cancel, press the [EXIT] button.

4. To execute, press the [ENTER] button.
A confirmation screen appears once again.
5. Press the [ENTER] button once again.
When formatting is complete, the screen indicates “Completed!”

The folder structure of a USB flash drive

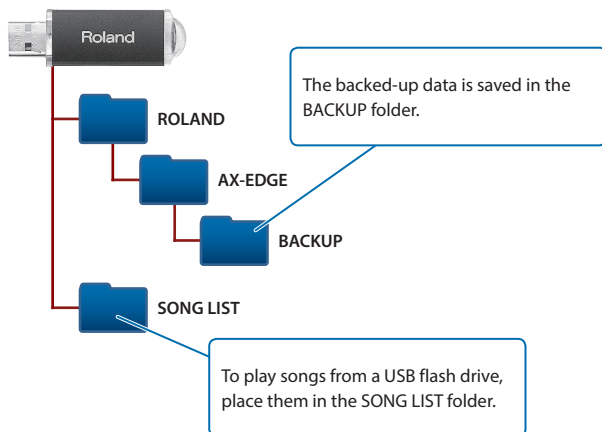

Editing the System Settings (SYSTEM)

Here's how to edit system parameters.

1. Press the [MENU/WRITE] button.
2. Use the cursor [◀] [▶] buttons to select “SYSTEM,” and then press the [ENTER] button.
3. Use the cursor [◀] [▶] buttons to select the parameter that you want to edit, and use the [-] [+] buttons to edit the value.

For details, refer to “Parameter Guide (English)” (PDF).

Saving the System Settings (System Write)

1. In the SYSTEM screen, hold down the [SHIFT] button and press the [MENU/WRITE] button.
A confirmation message appears.
If you decide to cancel, press the [EXIT] button.
2. To save, press the [ENTER] button.

Viewing the Program Version (VERSION INFO)

Here's how to view the version of the AX-Edge's system program.

1. Press the [MENU/WRITE] button.
2. Use the cursor [◀] [▶] buttons to select “VERSION INFO,” and then press the [ENTER] button.

Roland AX-Edge: Digital Keyboard

Keyboard	49 keys (with velocity and channel aftertouch)
Power Supply	DC 9 V AC adaptor, AA-type rechargeable Ni-MH batteries (sold separately) x 8
Current Draw	1,000 mA * Expected battery life under continuous use: Rechargeable nickel metal hydride batteries: approximately 5 hours (When using batteries having a capacity of 1900 mAh.) (approximately 4 hours if USB flash drive is connected) These figures will vary depending on the actual conditions of use. * Carbon-zinc or alkaline batteries cannot be used
Dimensions	1,252 (W) x 291 (D) x 85 (H) mm 49-5/16 (W) x 11-1/2 (D) x 3-3/8 (H) inches
Weight (without batteries and strap)	4.2 kg/ 9 lbs 5 oz
Accessories	Owner's Manual, Leaflet "USING THE UNIT SAFELY" , AC Adaptor, Power cord, Strap, Blade panel (including Hex key, screws), Ferrite core (including Band for fastening the core)
Options	Stand for AX-Edge (ST-AX2), Pedal switch: DP series, Expression pedal (EV-5)

* This document explains the specifications of the product at the time that the document was issued. For the latest information, refer to the Roland website.

English

日本語

Deutsch

Français

Italiano

Español

Português

Nederlands

USING THE UNIT SAFELY

WARNING

Concerning the Auto Off function

The power to this unit will be turned off automatically after a predetermined amount of time has passed since it was last used for playing music, or its buttons or controls were operated (Auto Off function). If you do not want the power to be turned off automatically, disengage the Auto Off function (p. 8).



Use only the supplied AC adaptor and the correct voltage

Be sure to use only the AC adaptor supplied with the unit. Also, make sure the line voltage at the installation matches the input voltage specified on the AC adaptor's body. Other AC adaptors may use a different polarity, or be designed for a different voltage, so their use could result in damage, malfunction, or electric shock.



WARNING

Use only the supplied power cord

Use only the attached power cord. Also, the supplied power cord must not be used with any other device.



CAUTION

Keep small items out of the reach of children

To prevent accidental ingestion of the parts listed below, always keep them out of the reach of small children.



- Included Parts
Hex key, screws (p. 8)
- Removable Parts
Screws (p. 8)

CAUTION

Handle the ground terminal carefully

If you remove the screw from the ground terminal, be sure to replace it; don't leave it lying around where it could accidentally be swallowed by small children. When refastening the screw, make that it is firmly fastened, so it won't come loose.



Handle the blade panel carefully

The tip of the blade panel is sharp; handle it carefully to avoid injury.



IMPORTANT NOTES

Power Supply: Use of Batteries

- If operating this unit on batteries, please use rechargeable Ni-MH batteries.

Placement

- Do not allow objects to remain on top of the keyboard. This can be the cause of malfunction, such as keys ceasing to produce sound.
- Depending on the material and temperature of the surface on which you place the unit, its rubber feet may discolor or mar the surface.
- Do not lean this product against a wall or similar object. It may fall over and be damaged, causing malfunctions.

Repairs and Data

- Before sending the unit away for repairs, be sure to make a backup of the data stored within it; or you may prefer to write down the needed information. Although we will do our utmost to preserve the data stored in your unit when we carry out repairs, in some cases, such as when the memory section is physically damaged, restoration of the stored content may be impossible. Roland assumes no liability concerning the restoration of any stored content that has been lost.

Additional Precautions

- Any data stored within the unit can be lost as the result of equipment failure, incorrect operation, etc. To protect yourself against the irretrievable loss of data, try to make a habit of creating regular backups of the data you've stored in the unit.
- Roland assumes no liability concerning the restoration of any stored content that has been lost.
- Never strike or apply strong pressure to the display.
- Use only the specified expression pedal. By connecting any other expression pedals, you risk causing malfunction and/or damage to the unit.

Using External Memories

- Please observe the following precautions when handling external memory devices. Also, make sure to carefully observe all the precautions that were supplied with the external memory device.
 - Do not remove the device while reading/writing is in progress.
 - To prevent damage from static electricity, discharge all static electricity from your person before handling the device.

Caution Regarding Radio Frequency Emissions

- The following actions may subject you to penalty of law.
 - Disassembling or modifying this device.
 - Removing the certification label affixed to the back of this device.

Intellectual Property Right

- The copyright of content in this product (the sound waveform data, style data, accompaniment patterns, phrase data, audio loops and image data) is reserved by Roland Corporation.
- Purchasers of this product are permitted to utilize said content (except song data such as Demo Songs) for the creating, performing, recording and distributing original musical works.
- Purchasers of this product are NOT permitted to extract said content in original or modified form, for the purpose of distributing recorded medium of said content or making them available on a computer network.
- This product contains eParts integrated software platform of eSOL Co., Ltd. eParts is a trademark of eSOL Co., Ltd. in Japan.
- The Bluetooth® word mark and logos are registered trademarks owned by Bluetooth SIG, Inc. and any use of such marks by Roland is under license.
- This Product uses the Source Code of µT-Kernel under T-License 2.0 granted by the T-Engine Forum (www.tron.org).
- Roland, BOSS are either registered trademarks or trademarks of Roland Corporation in the United States and/or other countries.
- Company names and product names appearing in this document are registered trademarks or trademarks of their respective owners.