

# ROSCO



**CubeConnect™**  
DESIGNED BY THE BLACK TANK

USER'S MANUAL



# Table of Contents

## Your CubeConnect™ Transceiver

Product Description.....	5
Transceiver Modes.....	6
What's In the Box.....	7
CubeConnect™ Transceiver Interface.....	8
CubeConnect Compression Propagation.....	9

## CubeConnect™ Transceiver Modes

Basic Operation.....	11
Normal Input Mode.....	12
Locked Mode.....	13
DB9 Serial In Mode.....	15
Bluetooth In Mode.....	17
DMX In Mode.....	20
Wireless In Mode.....	21

## CubeConnect™ Transceiver Configurations

Antenna Mounting Options.....	22
Using Multiple Transceivers.....	23
Dongle Pairing.....	26

# Table of Contents

## **Your CubeConnect™ Dongle**

Product Description.....	27
What's In the Box.....	28
CubeConnect™ Dongle Interface.....	29

## **CubeConnect™ Dongle Modes**

Basic Operation.....	30
Network Operation.....	32

## **CubeConnect™ Dongle Support**

FCC Warning.....	35
------------------	----

### **CubeConnect™ Transceiver**

The Transceiver provides a way of sending wireless lighting control information to CubeConnect™ Dongles or wireless fixtures with antennas. It can also serve as a receiver itself and act as a wireless in, DMX out endpoint.

The Transceiver accepts lighting control commands (input) from DMX512, BlueTooth Limited Energy (BLE)\*, or a Serial DB9 connection, and sends the data back out on either the wireless antenna or on the DMX output.

The Transceiver also has a locking function that can hold the last sent lighting intensity values. This provides the capability of remembering and holding a static scene indefinitely without the need of a permanently connected source.

# Transceiver Modes

**NOTE:** When using DMX Out of a Transceiver you can use any DMX Capable Device.

## Wireless In

DMX Out

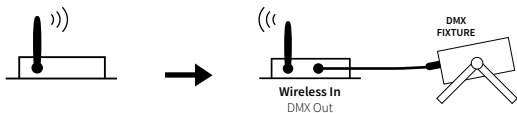

## Bluetooth In\*

Wireless/DMX Out

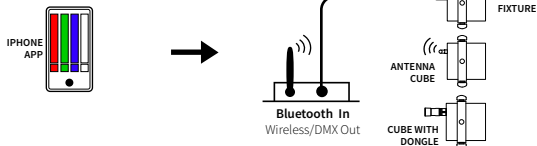

\*Bluetooth Technology Coming Soon

## DMX In

Wireless Out

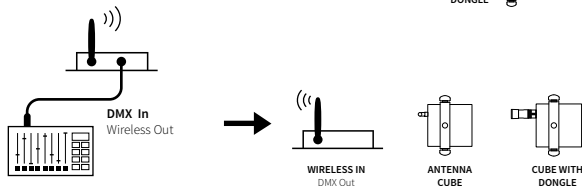

## Serial In

Wireless/DMX Out

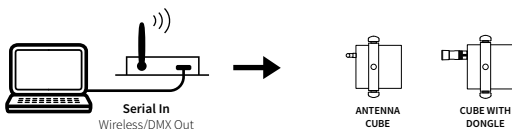

## What's In the Box

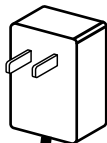

Power Supply

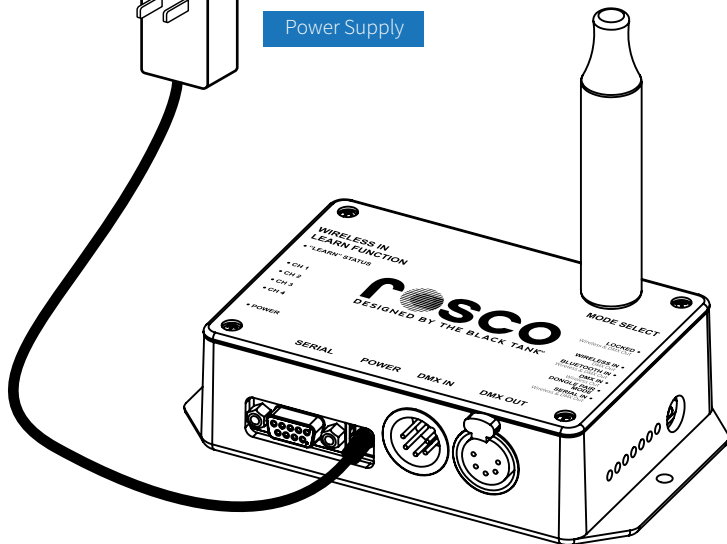

CubeConnect™ Transceiver

# CubeConnect™ Transceiver Interface

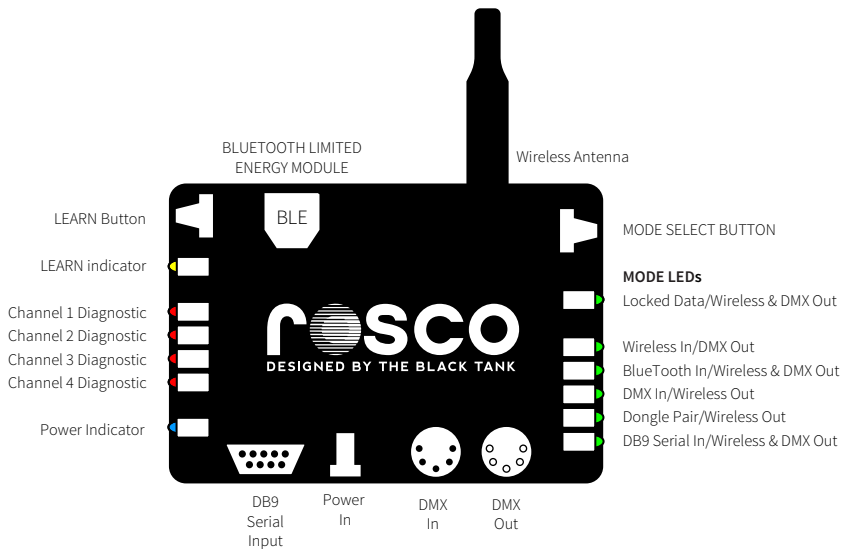



## CubeConnect Compression Propagation

The CubeConnect system was designed for applications which can not support expensive 3rd party full-speed wireless DMX hardware, but require dynamic or static effects. The patented CubeConnect algorithm automatically compresses the incoming DMX data to maximize throughput to the dongles by only sending DMX channels which changed from the previous frame.

Creative techniques can be implemented to maximize the CubeConnect performance when many fixtures are being controlled:

Doubling up fixtures addresses will help minimize propagation delay. Shows can also be composed with the compression method in mind. For example, instead of a normal cross fade from red to green, a "streak" effect could be applied - this is a common effect used by programmers and can be used here to creatively optimize the performance of the entire system (as only 1 address is changing at any point in time).

See chart on the next page for a detailed prediction of the propagation delay.

## CubeConnect Compression Propagation

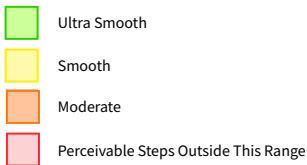
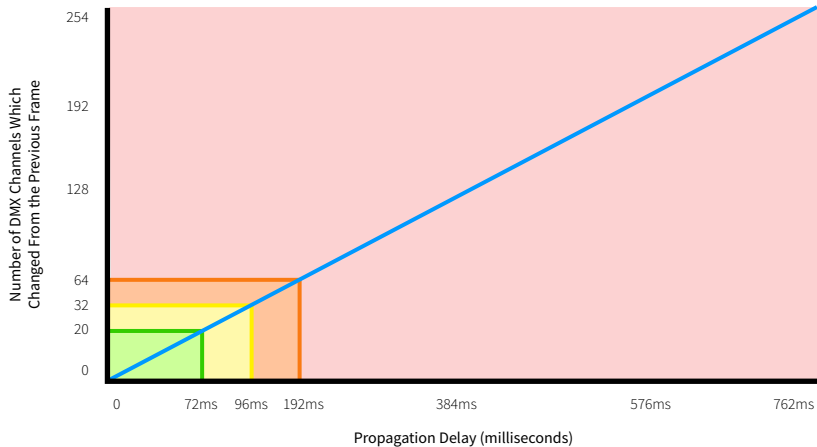

## Basic Operation

Apply power (5VDC) to CubeConnect™ Transceiver (the Blue Power Indicator will illuminate). Select desired mode using **MODE SELECT BUTTON**. The current Mode will be shown on the mode LEDs. Connect a lighting control device to the DMX IN, Bluetooth\*, or DB9 Serial input, depending on the mode selected. Put the wireless lights being controlled into "SERIAL" mode and set up their "Serial Address" (1-254 allowed). Begin sending data from the source device to control the wireless lights. Data sent to the DMX input must conform to the DMX512 protocol. Data sent to the BlueTooth Module or DB9 Serial input must conform to the "MINI-SSC" protocol which is sent out at the standard 9600 baud rate. Make sure you are sending data to the same channel numbers that the wireless lights are programmed for.

In the modes LOCKED, BLUETOOTH IN\*, and DB9 SERIAL IN, the unit outputs the lighting data to both the DMX OUTPUT and to the wireless antenna. In the WIRELESS IN mode, data is sent out only on DMX OUT. In the DMX IN mode, data is sent out only on the wireless antenna.

The four channels of diagnostic indicators on the left side of the unit respond to channels 1, 2, 3, and 4 input data. This allows some troubleshooting capability to see if the data input is working.

**\*Bluetooth Technology Coming Soon**

## Normal Input Mode Operation

When an input mode is selected (DMX, BLUETOOTH\*, or DB9 SERIAL), intensity (channel) data is received and put onto the "Input Buffer" based on its channel number. The data is then sent out to the fixture using the Radio Antenna and the DMX out connector, unless in DMX input mode.

### NORMAL INPUT MODE OPERATION

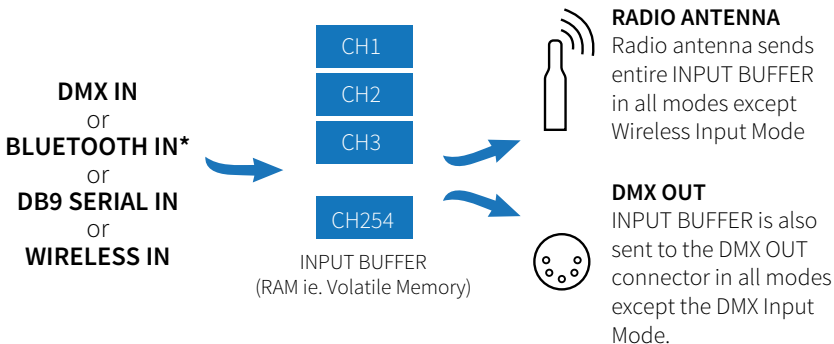

\*Bluetooth Technology Coming Soon

## Locked Mode Operation

The microprocessor continuously sends a copy of the INPUT BUFFER data to either the wireless radio antenna or to the DMX OUT connector (or both), depending on the mode selected.

The INPUT BUFFER is in RAM, which is volatile memory. Thus if you leave the Transceiver in an INPUT MODE and power cycle it, all the channel data in the BUFFER will be lost and would need to be re-sent to be valid again.

### LOCKED MODE OPERATION

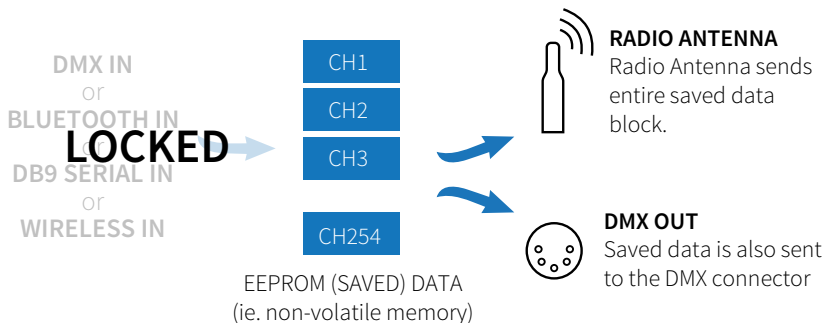

## Locked Mode Operation

To solve this problem, a **LOCKED MODE** is available. To access the LOCKED MODE, simply push the MODE SELECT BUTTON until the LOCKED MODE LED illuminates. Upon entry into the LOCKED MODE, the entire INPUT BUFFER is written into EEPROM, which is non-volatile memory. While operating in the LOCKED MODE, all data sent out to the wireless antenna and the DMX OUT connector is based on the data saved in the EEPROM. Additionally, none of the data input sources are actively receiving new data into the unit.

The MINI-SSC Command to put the Transceiver into the LOCKED MODE:

CHARACTER 1

**[255]**

(Sync Marker)

CHARACTER 2

**[0]**

(Channel #)

CHARACTER 3

**[1]**

(Intensity Setting)

The MINI-SSC Command to take the Transceiver out of the LOCKED MODE:

CHARACTER 1

**[255]**

(Sync Marker)

CHARACTER 2

**[0]**

(Channel #)

CHARACTER 3

**[0]**

(Intensity Setting)

## DB9 Serial In/Wireless & DMX Out Operation

When **DB9 Serial IN / WIRELESS & DMX OUT** is selected, the microprocessor takes ASCII characters in from the DB9 Serial Connector on the unit.

The application sending data to the Transceiver must send the characters so that they conform to the MINI-SSC Protocol which is sent out at the standard 9600 baud rate.

The Transceiver is programmed to listen for channels 1 through 254, for a total of 254 individual controllable channels. Channel 0 is reserved for commands which can put the Transceiver into the LOCKED MODE, or take it out of the LOCKED MODE.

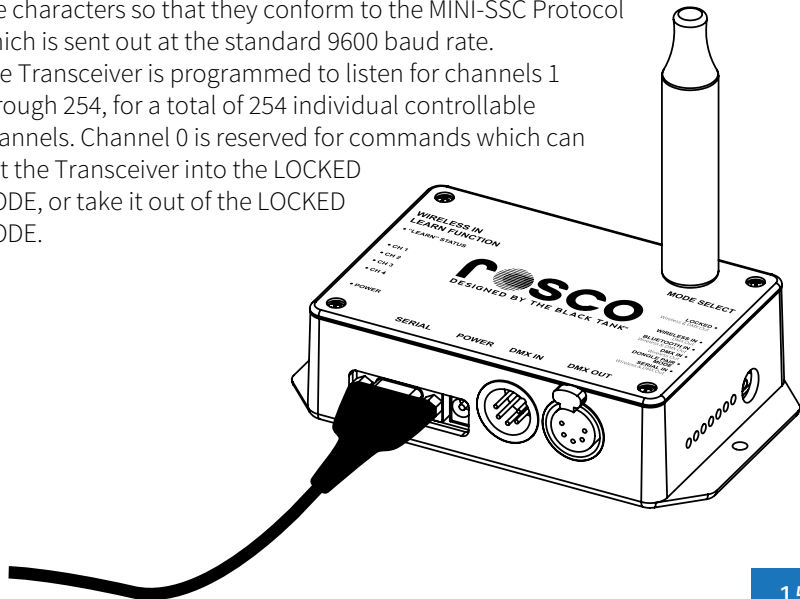

## DB9 Serial In/Wireless & DMX Out Operation

### How It Works

If a wireless light is put into SERIAL Mode, and set to Serial Address #1, the MINI-SSC Command to put the Red LEDs (channel #1) of that light to full on (100% on) would be:

CHARACTER 1

**[255]**

(Sync Marker)

CHARACTER 2

**[1]**

(Channel #)

CHARACTER 3

**[254]**

(Intensity Setting)

The MINI-SSC Command to turn the Green LEDs (channel #2) of the same fixture to 50% intensity would be:

CHARACTER 1

**[255]**

(Sync Marker)

CHARACTER 2

**[2]**

(Channel #)

CHARACTER 3

**[127]**

(Intensity Setting)

**NOTE:** When sending MINI-SSC commands, the maximum intensity that can be sent is 254.



## Bluetooth In/Wireless & DMX Out Operation

This Mode works exactly the same as the DB9 Serial Mode (MINI-SSC commands & Simple Serial commands). The only difference is that the data comes into the unit wirelessly using our Bluetooth Application\*. As with the DB9 Serial Mode, DMX data is generated when the MINI-SSC commands are used, and the LOCKED MODE can be commanded "on" and "off" with the application.

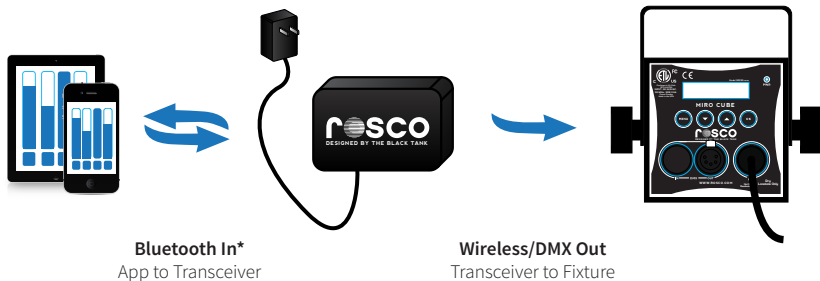

**\*Bluetooth Technology Coming Soon**

### Troubleshooting

In addition to the MINI-SSC Commands, the Transceiver is programmed to respond to simple serial commands which use printable ASCII characters. This allows for troubleshooting using the Laird Technologies BL600 iPhone app called *Laird Serial*. (The Android version is called "Laird Toolbox").\*

#### **The simple serial commands consist of a string of printable ASCII characters, made up of three parts:**

The first part of the string is a single character that denotes the color (channel number) that is being adjusted. It must be lower case and can only be a "r", "g", "b", or "w" which corresponds to channels 1, 2, 3 and 4.

The second part of the string must be from one to three numeric characters of intensity, and must be between 0 and 255 sent as separate ASCII numeric characters. "0" = off, "127"=50%, "255"=100%.

The third and final character in the string must be either a "space" or a "carriage return". This is a delimiter and indicates all the characters of the string have been received.

**\*Bluetooth Technology Coming Soon**

## Bluetooth In/Wireless & DMX Out Operation

For example, the string "r127 " is made up of the five ASCII characters 114 49 50 55 32, and will turn the red LEDs on half brightness.

**NOTE:** Any wireless light set to Serial Mode will respond to these simple serial commands regardless of which Serial Address they are set to.

If the simple serial commands are used, and any of the four color channels (r,g,b,w) are set to non-zero intensity setting using these commands, the MINI-SSC data being sent out of the Transceiver is temporarily disabled. When this happens, to re-enable the MINI-SSC commands, reset the four color channels to zero by using the simple serial commands, or power cycle the Transceiver. Power cycling the Transceiver sets the four color channels controlled by the simple serial commands to zero.

When using the simple serial commands to control lights, the resulting commanded color settings are also output on the DMX OUT connector. Since there are no channel numbers associated with the simple serial commands, all red channels in the half universe will be affected by the "r255" command. Likewise, all blue channels are affected by the "b255" command, and greens and whites act accordingly as well.

## DMX In/Wireless Out

When the **DMX In Mode** is selected, the unit takes half a universe (channels 1-254) of full speed DMX in, converts each channel to the MINI-SSC protocol, and then sends the MINI-SSC data out on the wireless antenna. This allows the Transceiver to act as a bridge between a DMX512 source and wireless lights.

The wireless MINI-SSC data out is sent at the standard 9600 baud 8N1 serial data settings. At these settings, the MINI-SSC output method cannot transmit the 254 channels at the same data rate as they come in on the DMX512 input. The microprocessor utilizes a compression algorithm to reduce the number of bytes being sent and to keep the data latency to a minimum.

One static scene of DMX IN data can be saved by putting the unit into the LOCKED MODE by pushing the MODE SELECT BUTTON until the SAVE MODE LED is illuminated. There is currently not a way to automatically enter the LOCKED MODE from the DMX IN MODE.

## Wireless In/DMX Out

When **Wireless In Mode** is selected, the 1/2 universe (channels 1-254) of MINI-SSC data coming in on the wireless antenna is converted and sent out as full speed DMX data on the DMX OUT connector.

This is similar to the BLUETOOTH Mode and the DB9 SERIAL Mode in that MINI-SSC data coming into the unit is converted and sent back out on the DMX OUT connector. The only difference is that the input data in this case is on the wireless antenna.

When a Transceiver is used as a DMX End Point (i.e. Wireless IN/DMX Out Mode), it should be paired to the sending Transceiver using the "LEARN" Button. A single push of the LEARN Button on the receiving Transceiver will result in 3 quick flashes of the Learn Status LED indicating the learning has taken place. Holding in the LEARN BUTTON for 12 seconds will cause all learned address to be forgotten, and is indicated by an extended amount of flashing on the Learn Status LED.

## Antenna Mounting Options

To move the antenna, remove the cover, unplug the antenna connector from the PCB, unscrew the antenna and move the antenna to the new location. Plug in connector and re-install cover.

**The wireless antenna can be mounted in two locations on the enclosure:**

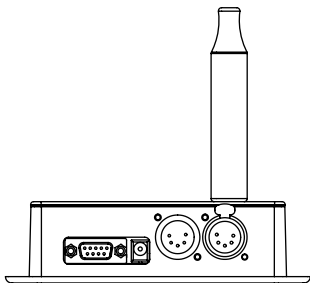

1) On the cover for desktop operations

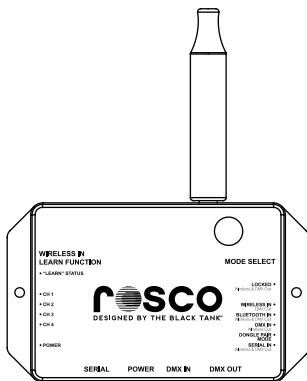

2) On the upper edge for wall mount operation

## Multiple Wireless Transceivers

There are special settings available when in the **DMX IN / WIRELESS OUT MODE** that allow up to three Transceivers to all transmit within range of each other, and not corrupt each others' transmissions. The way this is done is to establish one of the Transceivers as a Master and the others as Slaves, and to set a delay time for the Master based on how many Slaves are present.

If there are two Transceivers present, the Master transmits first, the Slave listens for Master to be done transmitting and then the Slave transmits. The Master's built in delay is set for one Slave and insures that the Slave will be done transmitting before the Master transmits again. This process continues with neither link transmitting while the other is transmitting.

### Master & Slave Indicators

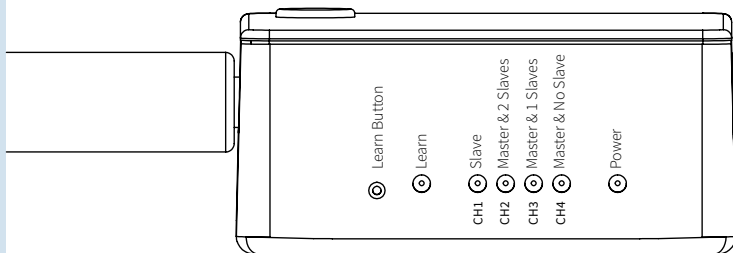

## Multiple Wireless Transceivers

If there are three Transceivers present, the Master starts the transmitting, the 1st Slave listens to the Master and begins transmitting when the Master is done, the 2nd Slave listens to the 1st Slave, and begins transmitting when the first Slave is done. The Master's built in delay is set to accommodate the time for both Slaves to finish before allowing the Master to transmit again.

To access Master/Slave settings, the Transceiver must be hard powered from off to on while the **MODE SELECT BUTTON** is held in. When you do this, two things will happen:

- 1) The top two MODE LEDS will illuminate indicating you are in the Master/Slave setup mode
- 2) The diagnostic indicators show the current Master/Slave setting (See pg.20)

You can now use the **MODE SELECT BUTTON** to select the Master/Slave setting that's desired. Turn the Transceiver off & back on to discontinue Master/Slave setup and resume normal operation.

**NOTE:** The current Master/Slave settings are briefly shown on the diagnostic LEDS during the Transceiver boot-up sequence



## Multiple Wireless Transceivers

When using multiple wireless Transceivers, the Slave Transceivers must be paired to the Transceivers they're listening for. For example, if there are two Transceivers present, the single Slave must be paired to the Master. If there are three Transceivers present, the 1st Slave must be paired to the Master, but the 2nd Slave must be paired to the 1st Slave.

Use the **LEARN BUTTON** to pair this Slave unit to the Transceiver it's listening for with the following procedure:

- 1) Put the Slave (the Transceiver that you are going to "learn") into Wireless IN/DMX Out mode.
- 2) Put the unit the Slave will be listening to into **DONGLE PAIR** mode.
- 3) Make sure these are the only two Transceivers powered up.
- 4) Push and hold the **LEARN BUTTON** on this unit for 12 seconds then release and verify **LEARN INDICATOR** flashes 15-20 times (this forces the unit to clear any "Learned" units from its memory).
- 5) Push and release the **LEARN BUTTON** again, then verify **LEARN INDICATOR** flashes 3-4 times (this teaches the unit to only listen to the "other" Transceiver).
- 6) Put this Slave unit back into **DMX IN/WIRELESS OUT** mode to use it as a multiple wireless slave Transceiver.

## Dongle Pairing

Selecting **Dongle Pairing Mode** allows a Wireless Dongle to be plugged directly into a Transceiver, and paired to it. Pairing is necessary if there are multiple Transceivers in an installation, otherwise Dongles will try to listen and be controlled by multiple Transceivers, and data reception will be unreliable.

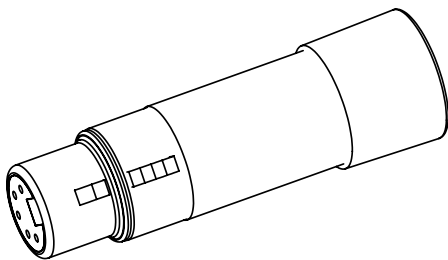

**NOTE:** When pairing a Dongle to a Transceiver, be sure to have only the Transceiver being used for pairing turned on; any other Transceivers in the vicinity must be turned off!

Another way to pair Dongles is to put the Transceivers into the **DMX In/Wireless Out Mode**. In either case you can find detailed pairing instructions for Dongles in the Dongle User Manual.

## Product Description

### **CubeConnect™ Dongle**

The CubeConnect™ Dongle is a 2.4Ghz radio receiver which plugs right into the back of a MIRO Cube™ or BRAQ Cube™, and accepts wireless lighting control data from a CubeConnect™ Transceiver.

The Dongle scavenges power from the MIRO Cube™ or BRAQ Cube™ DMX IN connector, and as a result, no power adapter is necessary. The radio technology used is not compatible with other wireless DMX products as it uses a proprietary wireless serial scheme. Line of sight range from Black Box to Dongle is between 1000-1500ft.

**NOTE:** CubeConnect™ Dongles will only receive data from CubeConnect™ Transceivers and only function when plugged into MIRO or BRAQ Cubes™.

## What's In the Box

CubeConnect™ Wireless Dongle

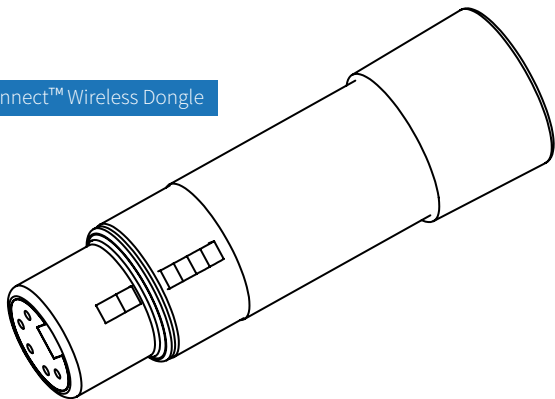

## CubeConnect™ Dongle Interface

### Pin Layout

- Pin 1 = ground
- Pin 2 = D1- (Power for Dongle)
- Pin 3 = D1+ (Power for Dongle)
- Pin 4 = D2- (Data from Dongle)
- Pin 5 = D2+ (Data from Dongle)

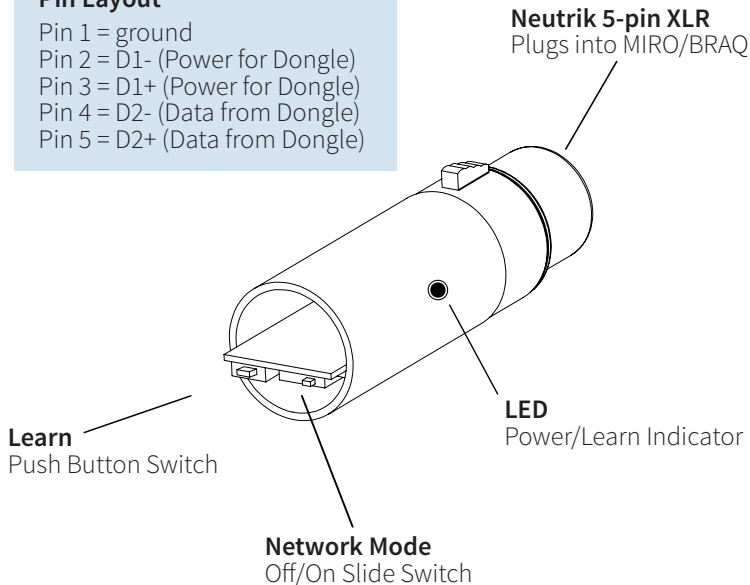

**NOTE:** Dongle shown with no end cap

## Basic Operation

### (Non-Networked - Network Slide Switch Set to Off)

Apply power to the MIRO/BRAQ Cube™ you will be using with the Dongle, and put it into **Serial Mode** via the Change Operate Mode menu choice. If “Serial Mode” does not come up as a choice, it needs to be enabled. (To enable “Serial Mode” select the Factory Setup menu choice and enter the password **3270**. Use the **MENU** key to go to the “Enable Serial Mode” screen, and push **OK**. Use **MENU** key to Exit Factory Setup, and “Serial Mode” should now be accessible in the Change Operate Mode menu choice. Put the MIRO/BRAQ into Serial Mode.)

Set the “Serial Address” to the desired fixture address. Addressing in Serial Mode is similar to addressing in DMX mode. With a 4C fixture, the selected address will be the Red Channel, with subsequent channels controlling Green, Blue, and White. For simplicity, set the Serial Address = 001 for now. With a WNC fixture, the selected address will be the Warm channel with subsequent channels controlling Neutral and Cool. With the Dongle unplugged from the MIRO/BRAQ Cube™, remove the End Cap and set the Network Mode Switch to the **OFF** position. With the MIRO/BRAQ Cube™ powered up, plug the Dongle into the DMX IN XLR connector and the blue Power/Learn Indicator on the Dongle should illuminate.

## Basic Operation

Apply power to a single Transceiver and put it into the DMX IN/Wireless Out mode. Begin sending DMX commands to channels 1, 2, 3, and 4. The MIRO/BRAQ Cube™ with the Dongle should respond to the DMX being sent to the Transceiver accordingly. When power is first applied it may take a few seconds for all the wireless controlled lights to become synchronized to the Transceiver.

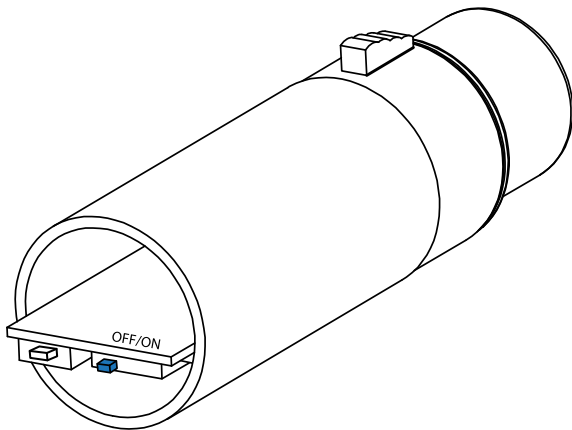

## Network Operation

### (Network Slide Switch Set to On)

In cases where the now wireless MIRO/BRAQ is blocked by a structure, or is physically too far away from the Transceiver for reliable data transmission, a second (or even a third) Transceiver can be used in an installation. Care must be used when using multiple CubeConnect™ Transceivers because they will interfere with each other if not set up properly. Only use multiple Transceivers when necessary.

If multiple Transceivers are necessary, there are setup functions built into the Transceivers to insure that they won't interfere with each other. See the users guide for Transceivers for more information on using multiple wireless Transceivers.

When using more than one Transceiver in an installation, the dongles must be "paired" (learned) to the Transceiver intended for it. To pair a Dongle to a Transceiver, use the following procedure:

- 1)** Make sure the Transceiver you are pairing to is turned on and is in the "Dongle Pair" mode. Also make sure there is not another Transceiver nearby that is turned on.
- 2)** Remove the Dongle from the MIRO/BRAQ



## Network Operation

**3)** Remove the End Cap from the Dongle and move the Network Slide Switch to the "ON" position.

**4)** Insert the Dongle back into MIRO/BRAQ or into the Transceiver being used. (If you insert into a MIRO/BRAQ it will need to be in "Serial Mode" for the Dongle to work)

**Steps 5&6 will clear the Dongles memory from all previous pairings. This is Necessary if the dongle had been previously paired to a different Transceiver that is still in use and within range of the dongle.**

**5)** Push and hold the **LEARN PUSH BUTTON** for a full 12 seconds. The Dongle power LED will turn off while the switch is held.

**6)** Release the **LEARN SWITCH** after 12 seconds. Verify that the Dongle Power/Learn LED quickly flashes on/off many times (20 or so) over a 5 second time frame, after which the LED stays solid on.

**7)** Push and release the **LEARN PUSH BUTTON**. Verify the Power/Learn LED flashes at a slower normal speed, after which it stays solid on.

**8)** Replace the End Cap.

**9)** The Dongle is now paired to the Transceiver that was turned on and transmitting in Dongle Pair Mode.

## Network Operation

- 10) Put the Transceiver back into the desired mode (the mode it was in before moving it to "Dongle Pair" mode)
- 11) The Dongle will only listen to a paired Transceiver and will ignore all other data. Care must be taken because Dongles do not automatically clear previous pair settings when a new pairing is established. Dongles must be manually cleared if they were previously paired using steps 5 & 6 above.

**NOTE:** Dongle should be inserted into the DMX IN connector.

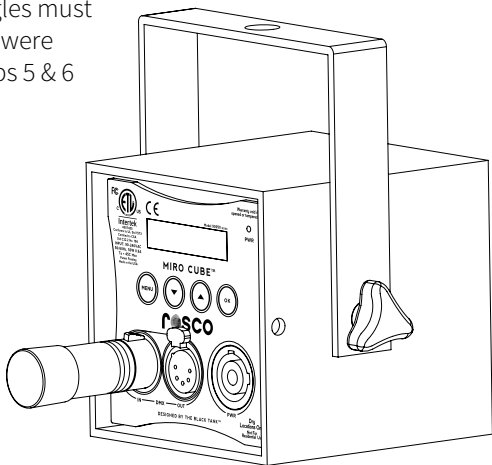

## FCC Warning

This equipment has been tested and found to comply with the regulations for a Class A digital device, pursuant to Part 15 of the FCC Rules. These limits are designed to provide reasonable protection against harmful interference when the equipment is operated in a commercial environment. This equipment generates, uses, and can radiate radio frequency energy and, if not installed and used in accordance with this user's guide, may cause harmful interference to radio communications. Operation of this equipment in a residential area is likely to cause harmful interference, in which case the user will be required to correct the interference at his own expense.



**ROSCO**

**CubeConnect™**  
DESIGNED BY THE BLACK TANK