

Line Dancer

User Manual

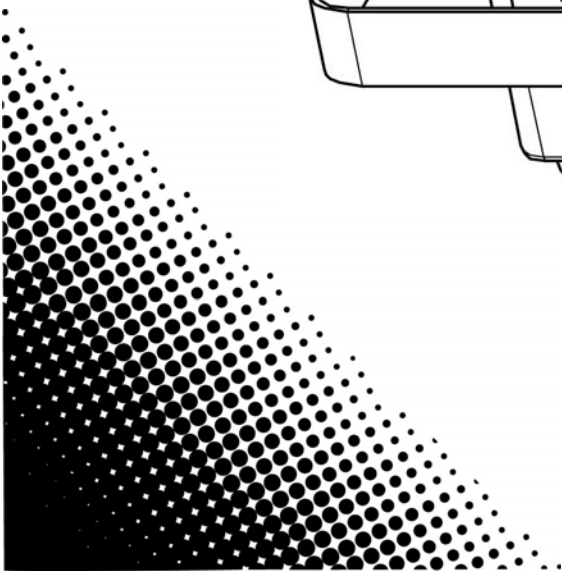
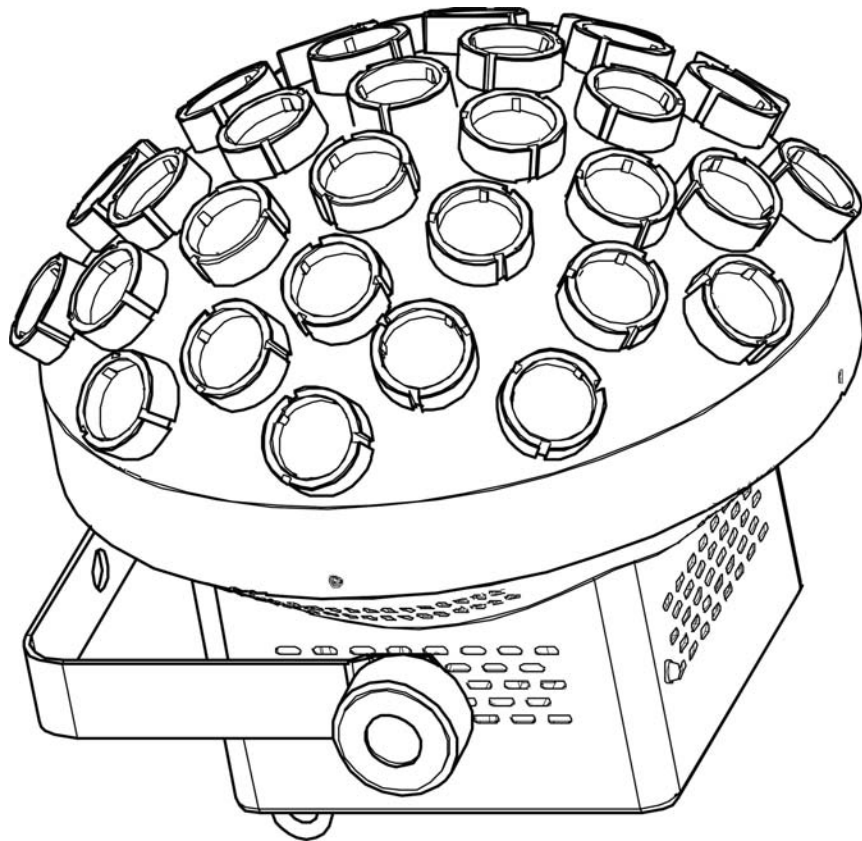

CHAUVET

TABLE OF CONTENTS

1. Before You Begin	1
What Is Included	1
Unpacking Instructions.....	1
Claims	1
Text Conventions	1
Symbols	1
Disclaimer	1
Product at a Glance	2
Safety Notes.....	2
2. Introduction	3
Product Overview.....	3
Product Dimensions.....	3
3. Setup	4
AC Power	4
Fuse Replacement.....	4
Power Linking.....	4
Mounting	5
Orientation.....	5
Rigging	5
4. Operation	6
Control Panel Operation.....	6
Menu Map	6
Configuration (DMX)	6
Starting Address.....	6
DMX Channel Assignments and Values	7
6Ch.....	7
3Ch.....	8
Configuration (Standalone)	8
Automatic Programs.....	8
Auto-Program Speed	8
Motor Speed.....	8
Sound-Active Mode	9
Preset Color Mode	9
IRC-6 Infrared Remote Control	9
IRC-6 Operation	9
Master/Slave Mode	10
5. Maintenance	11
Product Maintenance	11
6. Technical Specifications	12
Returns	13
Contact Us	14

1. Before You Begin

What Is Included

- Line Dancer
- Power Cord
- Warranty Card
- Quick Reference Guide

Unpacking Instructions

Carefully unpack the product immediately and check the container to make sure all the parts are in the package and are in good condition.

Claims





If the box or the contents (the product and included accessories) appear damaged from shipping, or show signs of mishandling, notify the carrier immediately, not Chauvet. Failure to report damage to the carrier immediately may invalidate your claim. In addition, keep the box and contents for inspection.

For other issues, such as missing components or parts, damage not related to shipping, or concealed damage, file a claim with Chauvet within 7 days of delivery.

Text Conventions

Convention	Meaning
1–512	A range of values
50/60	A set of values of which only one can be chosen
Settings	A menu option not to be modified
<ENTER>	A key to be pressed on the product's control panel
ON	A value to be entered or selected

Symbols

Symbol	Meaning
	Electrical warning. Not following these instructions may cause electrical damage to the product, accessories, or the user.
	Critical installation, configuration, or operation information. Not following these instructions may make the product not work, cause damage to the product, or cause harm to the operator.
	Important installation or configuration information. The product may not function correctly if this information is not used.
	Useful information.

Disclaimer

Chauvet believes that the information contained in this manual is accurate in all respects. However, Chauvet assumes no responsibility and specifically disclaims any and all liability to any party for any loss, damage or disruption caused by any errors or omissions in this document, whether such errors or omissions result from negligence, accident or any other cause. Chauvet reserves the right to revise the content of this document without any obligation to notify any person or company of such revision, however, Chauvet has no obligation to make, and does not commit to make, any such revisions. Download the latest version from www.chauvetdj.com.









The works of authorship contained in this manual, including, but not limited to, all design, text and images are owned by Chauvet.

© Copyright 2017 Chauvet & Sons, LLC. All rights reserved.

Electronically published by Chauvet in the United States of America.

CHAUVET, the Chauvet logo, and Line Dancer are registered trademarks or trademarks of Chauvet & Sons LLC (d/b/a Chauvet and Chauvet Lighting) in the United States and other countries. Other company and product names and logos referred to herein may be trademarks of their respective companies.

Product at a Glance

Use on Dimmer		Auto Programs	
Outdoor Use		Auto-ranging Power Supply	
Sound-Active		Replaceable Fuse	
DMX		User-Serviceable	
Master/Slave			

Safety Notes



- Always connect the product to a grounded circuit to avoid the risk of electrocution.
 - Always disconnect the product from the power source before cleaning or replacing the fuse.
 - Avoid direct eye exposure to the light source while the product is on.
 - Make sure the power cord is not crimped or damaged.
 - Never disconnect the product from power cord by pulling or tugging on the cord.
 - If mounting the product overhead, always secure to a fastening device using a safety cable.
 - Make sure there are no flammable materials close to the product when operating.
 - Do not touch the product's housing when operating because it may be very hot.
-
- Always make sure that the voltage of the outlet to which you are connecting the product is within the range stated on the decal or rear panel of the product.
 - The product is for indoor use only! (IP20) To prevent risk of fire or shock, do not expose the product to rain or moisture.
 - Always install the product in a location with adequate ventilation, at least 20 in (50 cm) from adjacent surfaces.
 - Be sure that no ventilation slots on the product's housing are blocked.
 - Never connect the product to a dimmer.
 - Make sure to replace the fuse with another of the same type and rating.
 - Never carry the product from the power cord or any moving part. Always use the hanging/mounting bracket.
 - The maximum ambient temperature (Ta) is 104 °F (40 °C). Do not operate the product at higher temperatures.
 - In the event of a serious operating problem, stop using the product immediately.
 - Never try to repair the product. Repairs carried out by unskilled people can lead to damage or malfunction. Please contact the nearest authorized technical assistance center.
 - To eliminate unnecessary wear and improve its lifespan, during periods of non-use completely disconnect the product from power via breaker or by unplugging it.



Keep this User Manual for future use. If you sell the product to someone else, be sure that they also receive this document.

2. Introduction

Product Overview

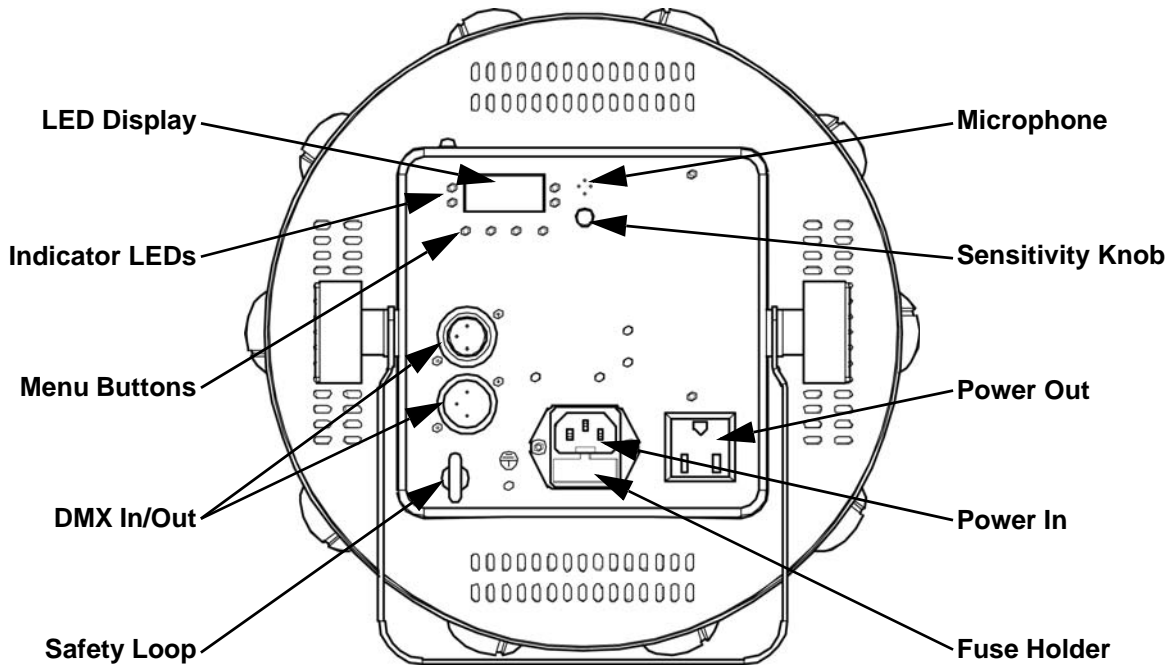

Product Dimensions

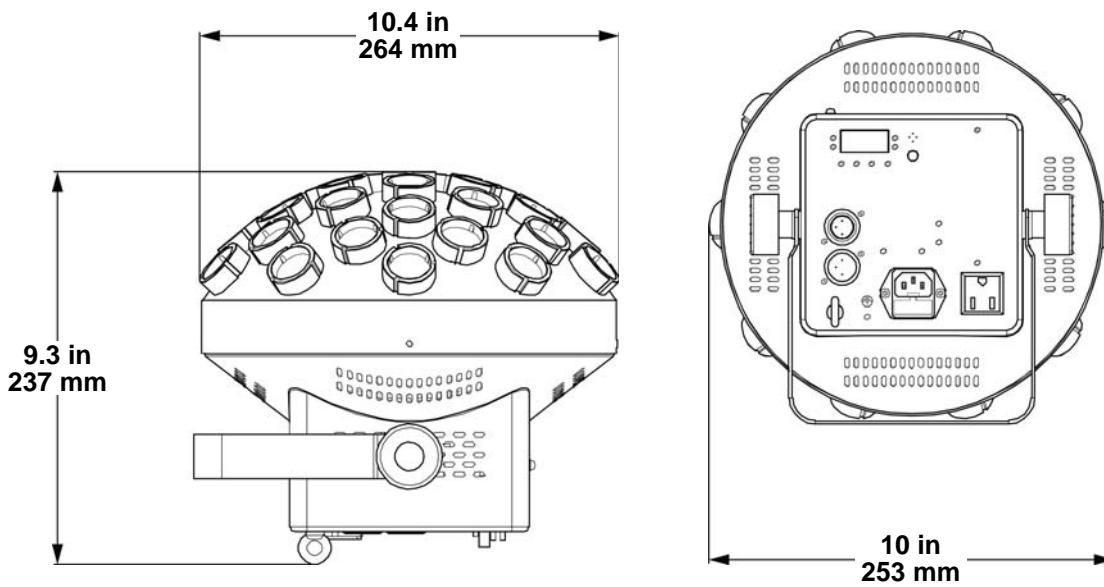

3. Setup

AC Power

The Line Dancer has an auto-ranging power supply and it can work with an input voltage range of 100 to 240 VAC, 50/60 Hz. To determine the product's power requirements (circuit breaker, power outlet, and wiring), use the current value listed on the label affixed to the product's back panel, or refer to the product's specifications chart. The listed current rating indicates the product's average current draw under normal conditions.



- **Always connect the product to a protected circuit (a circuit breaker or fuse). Make sure the product has an appropriate electrical ground to avoid the risk of electrocution or fire.**
- **To eliminate unnecessary wear and improve its lifespan, during periods of non-use completely disconnect the product from power via breaker or by unplugging it.**



Never connect the product to a rheostat (variable resistor) or dimmer circuit, even if the rheostat or dimmer channel serves only as a 0 to 100% switch.

Fuse Replacement

1. Wedge the tip of a flat-head screwdriver into the slot of the fuse holder.
2. Pry the fuse holder out of the housing.
3. Remove the blown fuse from the holder and replace with a fuse of the exact same type and rating.
4. Insert the fuse holder back in place and reconnect power.

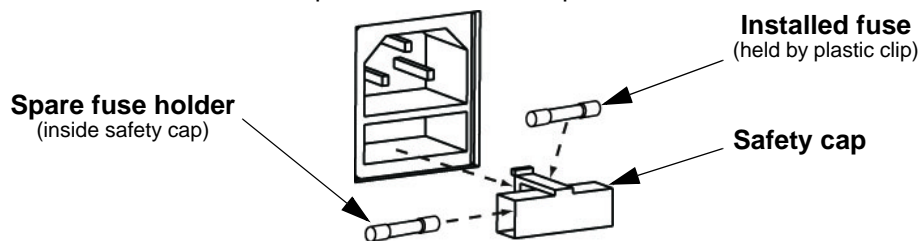

Disconnect the product from the power outlet before replacing the fuse.

Power Linking

The product provides power linking via the Edison outlet located in the back of the product. Please see the diagram below for further explanation.

Power Linking Diagram

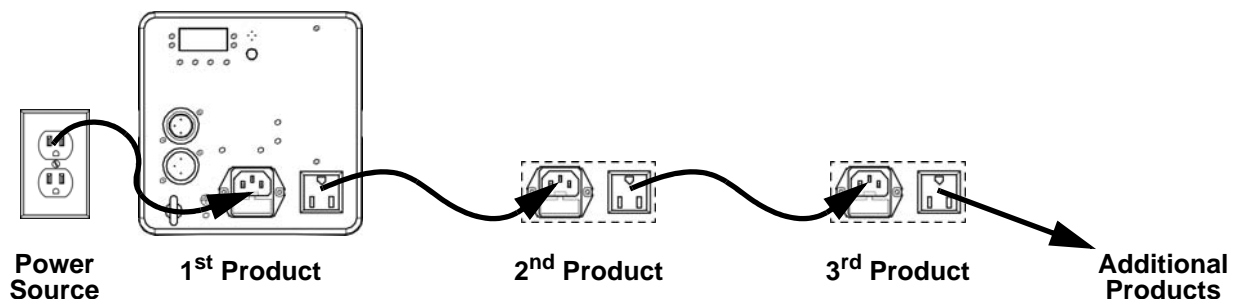

You can power link up to 12 Line Dancer products on 120 VAC or up to 25 Line Dancer products on 230 VAC.



The power linking diagram corresponds to the North American version of the product ONLY! If using the product in other markets, you must consult with the local Chauvet distributor as power linking connectors and requirements may differ in your country or region.

Mounting

Before mounting the product, read and follow the safety recommendations indicated in the [Safety Notes](#).

Orientation

The Line Dancer may be mounted in any position; however, make sure adequate ventilation is provided around the product.

Rigging

- Before deciding on a location, always make sure there is easy access to the product for maintenance and programming purposes.
- Make sure adequate ventilation is provided around the product.
- Make sure that the structure or surface onto which you are mounting the product can support the product's weight. (see the [Technical Specifications](#))
- When mounting the product overhead, always use a safety cable. Mount the product securely to a rigging point, whether an elevated platform or a truss.
- When rigging the product onto a truss, use a mounting clamp of appropriate weight capacity.
- When power linking multiple products, mount the products close enough for power linking cables to reach.
- The bracket adjustment knobs allow for directional adjustment when aiming the product to the desired angle. Only loosen or tighten the bracket knobs manually. Using tools could damage the knobs.

Mounting Diagram

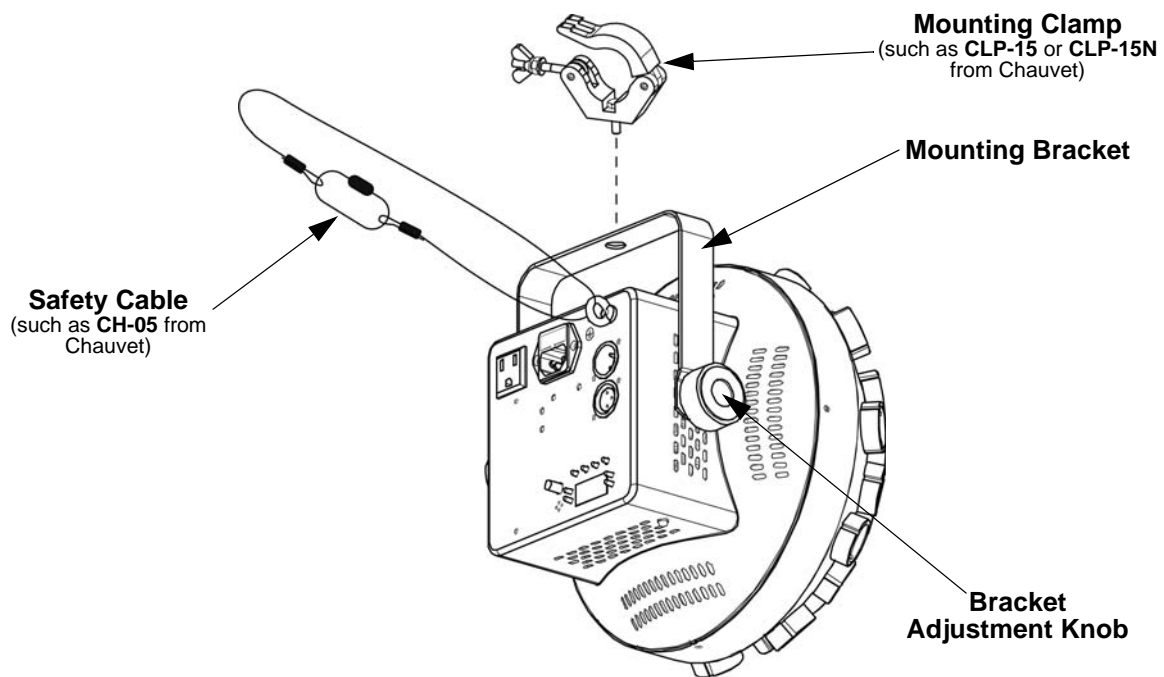

4. Operation

Control Panel Operation

To access the control panel functions, use the four buttons located underneath the display. Please refer to the [Product Overview](#) to see the button locations on the control panel.

Button	Function
<MENU>	Press to find an operation mode or to back out of the current menu option
<UP>	Press to scroll up the list of options or to find a higher value
<DOWN>	Press to scroll down the list of options or to find a lower value
<ENTER>	Press to activate a menu option or a selected value

Menu Map

Mode	Programming Levels		Description
DMX Mode	3Ch	d001–510	3-channel DMX mode
	6Ch	d001–507	6-channel DMX mode
Static Colors	C--	C 1–7	Static colors
Automatic Programs	P--	P 1–13	Automatic programs
Auto Speed	S--	S. 1–100	Program speed for P1–13
Motor Speed	M--	M. 0–100	Motor speed
Sound-Active Mode	Snd	Snd1–13	Sound-active programs
Infrared Mode	SEt	on	Turns infrared on or off
		oFF	

Configuration (DMX)

The Line Dancer works with a DMX controller. Information about DMX is in the CHAUVET DMX Primer, which is available from the Chauvet website http://www.chauvetlighting.com/downloads/DMX_Primer_rev05_WO.pdf.

Starting Address

When selecting a starting DMX address, always consider the number of DMX channels the selected DMX mode uses. If you choose a starting address that is too high, you could restrict the access to some of the product's channels.

The Line Dancer uses up to 6 DMX channels, which defines the highest configurable address as **507**.

If you are not familiar with the DMX protocol, download the DMX Primer from www.chauvetdj.com.

To select the starting address, do the following:

1. Press <MENU> repeatedly until **3Ch** or **6Ch** shows on the display.
2. Press <ENTER>.
3. Use <UP> or <DOWN> to select the starting address, from **d 1–510**.
4. Press <ENTER>.

DMX Channel Assignments and Values

6Ch

Channel	Function	Value	Percent/Setting
1	Static Color	000 ⇔ 005	No function
		006 ⇔ 045	Red
		046 ⇔ 086	Green
		087 ⇔ 127	Blue
		128 ⇔ 168	Yellow
		169 ⇔ 209	Magenta
		210 ⇔ 250	Cyan
		251 ⇔ 255	Red, green, and blue
2	Zone Control	000 ⇔ 062	All zones
		063 ⇔ 125	Zone 1
		126 ⇔ 188	Zones 2
		189 ⇔ 255	Zones 3
3	Strobe	000 ⇔ 005	No function
		006 ⇔ 250	Strobe, slow to fast
		251 ⇔ 255	Sound-active strobe
4	Auto Programs	000 ⇔ 005	No function
		006 ⇔ 024	Auto program 1
		025 ⇔ 044	Auto program 2
		045 ⇔ 064	Auto program 3
		065 ⇔ 084	Auto program 4
		085 ⇔ 104	Auto program 5
		105 ⇔ 124	Auto program 6
		125 ⇔ 144	Auto program 7
		145 ⇔ 164	Auto program 8
		165 ⇔ 184	Auto program 9
		185 ⇔ 204	Auto program 10
		205 ⇔ 224	Auto program 11
		225 ⇔ 244	Auto program 12
245 ⇔ 255	Auto program 13		
5	Auto Speed	000 ⇔ 250	Auto program speed, slow to fast
		251 ⇔ 255	Sound-active program
6	Motor Speed	000 ⇔ 001	No function
		002 ⇔ 255	Motor speed, slow to fast

3Ch

Channel	Function	Value	Percent/Setting
1	Auto Programs	000 ⇔ 005	No function
		006 ⇔ 024	Auto program 1
		025 ⇔ 044	Auto program 2
		045 ⇔ 064	Auto program 3
		065 ⇔ 084	Auto program 4
		085 ⇔ 104	Auto program 5
		105 ⇔ 124	Auto program 6
		125 ⇔ 144	Auto program 7
		145 ⇔ 164	Auto program 8
		165 ⇔ 184	Auto program 9
		185 ⇔ 204	Auto program 10
		205 ⇔ 224	Auto program 11
		225 ⇔ 244	Auto program 12
		245 ⇔ 255	Auto program 13
2	Auto Speed	000 ⇔ 250	Auto program speed, slow to fast
		251 ⇔ 255	Sound-active program
3	Motor Speed	000 ⇔ 001	No function
		002 ⇔ 255	Motor speed, slow to fast

Configuration (Standalone)

Set the product in one of the standalone modes to control without a DMX controller.



Never connect a product that is operating in any standalone mode to a DMX string connected to a DMX controller. Products in standalone mode may transmit DMX signals that could interfere with the DMX signals from the controller.

Automatic Programs

To run the Line Dancer in automatic mode, follow the instructions below:

1. Press **<MENU>** repeatedly until **P--** shows on the display.
2. Press **<ENTER>**.
3. Use **<UP>** or **<DOWN>** to select an automatic program, from **P 1–13**.
4. Press **<ENTER>**.

Auto-Program Speed

To change the auto-program speed on the Line Dancer, do the following:

1. Press **<MENU>** repeatedly until **S--** shows on the display.
2. Use **<UP>** or **<DOWN>** to increase or decrease the program speed, from **S. 1–100**.
3. Press **<ENTER>**. The product will return to the last selected mode.

Motor Speed

To set the motor speed in stand-alone mode, follow the instructions below:

1. Press **<MENU>** repeatedly until **M--** shows on the display.
2. Press **<ENTER>**.
3. Use **<UP>** or **<DOWN>** to increase or decrease the motor speed, from **M. 0–100**.

Sound-Active Mode

To run the Line Dancer in sound-active mode, do the following:

1. Press **<MENU>** repeatedly until **Snd** shows on the display.
2. Press **<ENTER>**.
3. Use **<UP>** or **<DOWN>** to select a sound-active program, from **Snd1–13**.
4. Press **<ENTER>**.
5. Turn the sensitivity knob up until the product responds to the beat of the music.



The product will only respond to low frequencies of music (bass and drums).

Preset Color Mode

To run the Line Dancer on a static color, follow the instructions below:

1. Press **<MENU>** repeatedly until **C--** shows on the display.
2. Press **<ENTER>**.
3. Use **<UP>** or **<DOWN>** to select a static color, from **C 1–7**.
4. Press **<ENTER>**.

IRC-6 Infrared Remote Control

The Line Dancer is compatible with the IRC-6 infrared remote control from Chauvet. To activate IR mode, follow the instructions below:

1. Press **<MENU>** repeatedly until **SEt** shows on the display.
2. Press **<ENTER>** to accept.
3. Press **<UP>** or **<DOWN>** to select **on** or **off**.
4. Press **<ENTER>**.

IRC-6 Operation

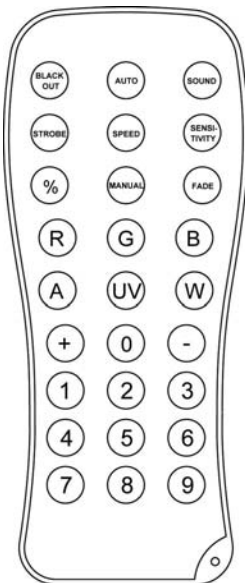

Automatic Mode

Automatic mode will enable you to run the automatic programs on the product.

To turn on Automatic mode:

1. Press **<AUTO>** on the IRC-6.
2. Press **<+>** or **<->** to choose between the different auto programs.

To adjust the speed of the automatic program:

1. Press **<SPEED>** on the IRC-6.
2. Press **<+>** or **<->** to increase or decrease the speed of the program.

Sound-Active Mode

Sound-Active mode will enable the product to respond to the music.

To turn on Sound-Active mode:

1. Press **<SOUND>** on the IRC-6.
2. Press **<+>** or **<->** to select a sound-active program.

Manual Color Control

To choose a specific color with the IRC-6:

1. Press **<R>** for red, **<G>** for green, **** for blue, **<A>** for yellow, **<P/UV>** for magenta, or **<W>** for red, green, and blue.
2. Press **<+>** or **<->** to select a color from **C 1–7**.

Strobe

To adjust the strobe rate of the static color:

1. Press **<STROBE>** on the IRC-6.
2. Press **<+>** or **<->** to increase or decrease the strobe rate, from **St.00–St.27**.
3. Set to **St.00** to turn off the strobe.

Black Out

To black out the lights:

1. Press **<BLACK OUT>** on the IRC-6.

This will turn off all the lights until the button is pressed again.

NOTE: The IRC-6 will not respond to any inputs when Black Out is activated. If the remote does not respond when a button is pressed, try pressing **<BLACK OUT>**. You may have inadvertently activated Black Out.

Master/Slave Mode

The Master/Slave mode allows a single Line Dancer product (the “master”) to control the actions of one or more Line Dancer products (the “slaves”) without the need of a DMX controller. The master product will be set to operate in either Stand-Alone mode or with the IRC-6, while the slave products will be set to operate in Slave mode. Once set and connected, the slave products will operate in unison with the master product. Configure the products as indicated below.

Slave products:

1. Press **<MENU>** repeatedly until **3Ch** or **6Ch** shows on the display.
2. Press **<ENTER>** to accept.
3. Set the DMX address to **001**.
4. Connect the DMX input of the first slave product to the DMX output of the master product.
5. Connect the DMX input of the subsequent slave products to the DMX output of the previous slave product.
6. Finish setting and connecting all the slave products.

Master product:

1. Set the master product to operate in Stand-Alone mode or with the IRC-6.
2. Make the master product the first product in the DMX daisy chain.
 - **Configure all the slave products before connecting the master to the daisy chain.**
 - **Never connect a DMX controller to a DMX string configured for Master/Slave operation because the controller may interfere with the signals from the master.**
 - **Do not connect more than 31 slaves to the master.**



5. Maintenance

Product Maintenance

Dust build-up reduces light output performance and can cause overheating. This can lead to reduction of the light source's life and/or mechanical wear. To maintain optimum performance and minimize wear, clean your lighting products at least twice a month. However, be aware that usage and environmental conditions could be contributing factors to increase the cleaning frequency.

To clean the product, follow the instructions below:

1. Unplug the product from power.
2. Wait until the product is at room temperature.
3. Use a vacuum (or dry compressed air) and a soft brush to remove dust collected on the external surface/vents.
4. Clean all transparent surfaces with a mild soap solution, ammonia-free glass cleaner, or isopropyl alcohol.
5. Apply the solution directly to a soft, lint free cotton cloth or a lens cleaning tissue.
6. Softly drag any dirt or grime to the outside of the transparent surface.
7. Gently polish the transparent surfaces until they are free of haze and lint.



Always dry the transparent surfaces carefully after cleaning them.

6. Technical Specifications

Dimensions and Weight

Length	Width	Height	Weight
9.3 in (237 mm)	10.4 in (264 mm)	10 in (253 mm)	2.6 lb (1.2 kg)

Note: Dimensions in inches rounded to the nearest decimal digit.

Power

Power Supply Type	Range	Voltage Selection
Switching (internal)	100 to 240 VAC, 50/60 Hz	Auto-ranging

Parameter	120 V, 60 Hz	230 V, 50 Hz
Consumption	36W	35 W
Operating Current	0.6 A	0.3 A
Power linking current (products)	8 A (12 products)	8 A (25 products)
Fuse	T 1.6 A, 250 V	T 1.6 A, 250 V

Power I/O	U.S./Worldwide	UK/Europe
Power input connector	IEC	IEC
Power output connector	Edison	IEC
Power Cord plug	Edison (U.S.)	Local Plug

Light Source

Type	Color	Quantity	Power	Current	Lifespan
LED	Tri-color RGB	27	1.5 W	0.6 A	50,000 hours

Photometrics

Strobe Rate	Coverage Angle
0 to 20 Hz	116°

Thermal

Maximum External Temperature	Cooling System
104 °F (40 °C)	Convection

DMX

I/O Connector	Channel Range
3-pin XLR	3 or 6

Ordering

Product Name	Item Code	UPC Number
Line Dancer	10051412	781462217600

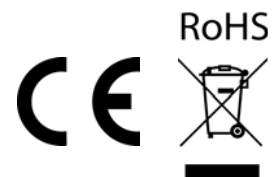

Returns

In case you need to get support or return a product:

- If you are located in the U.S., contact Chauvet World Headquarters.
- If you are located in the UK or Ireland, contact Chauvet Europe Ltd.
- If you are located in Mexico, contact Chauvet Mexico.
- If you are located in Benelux, contact Chauvet Europe BVBA.
- If you are located in any other country, DO NOT contact Chauvet. Instead, contact your local distributor. See www.chauvetdj.com for distributors outside the U.S., UK, Ireland, Mexico, or Benelux.



If you are located outside the U.S., UK, Ireland, Mexico, or Benelux, contact your distributor of record and follow their instructions on how to return Chauvet products to them. Visit our website www.chauvetdj.com for contact details.

Call the corresponding Chauvet Technical Support office and request a Return Merchandise Authorization (RMA) number before shipping the product. Be prepared to provide the model number, serial number, and a brief description of the cause for the return.

To submit a service request online, go to www.chauvetdj.com/service-request.

Send the merchandise prepaid, in its original box, and with its original packing and accessories. Chauvet will not issue call tags.

Clearly label the package with the RMA number. Chauvet will refuse any product returned without an RMA number.



Write the RMA number on a properly affixed label. DO NOT write the RMA number directly on the box.

Before sending the product, clearly write the following information on a piece of paper and place it inside the box:

- Your name
- Your address
- Your phone number
- RMA number
- A brief description of the problem

Be sure to pack the product properly. Any shipping damage resulting from inadequate packaging will be your responsibility. FedEx packing or double-boxing are recommended.



Chauvet reserves the right to use its own discretion to repair or replace returned product(s).

Contact Us

World Headquarters	
General Information	Technical Support
Address: 5200 NW 108th Ave. Sunrise, FL 33351 Voice: (954) 577-4455 Fax: (954) 929-5560 Toll Free: (800) 762-1084	Voice: (844) 393-7575 Fax: (954) 756-8015 Email: chauvetcs@chauvetlighting.com
	Website
	www.chauvetlighting.com
EUROPE	
General Information	Technical Support
Address: Stokstraat 18 9770 Kruishoutem Belgium Voice: +32 9 388 93 97	Email: eutech@chauvetlighting.eu
	Website
	www.chauvetlighting.eu
General Information	Technical Support
Address: Unit 1C Brookhill Road Industrial Estate Pinxton, Nottingham, UK NG16 6NT Voice: +44 (0) 1773 511115 Fax: +44 (0) 1773 511110	Email: uktech@chauvetlighting.com
	Website
	www.chauvetlighting.co.uk
MEXICO	
General Information	Technical Support
Address: Av. de las Partidas 34 - 3B (Entrance by Calle 2) Zona Industrial Lerma Lerma, México, C.P. 52000 Voice: +52 (728) 690-2010	Email: servicio@chauvet.com.mx
	Website
	www.chauvet.com.mx

Outside the U.S., United Kingdom, Ireland, Mexico or Benelux, contact the dealer of record. Follow the instructions to request support or to return a product. Visit our website for contact details.